

FLUIDS AND LUBRICATION EQUIPMENT

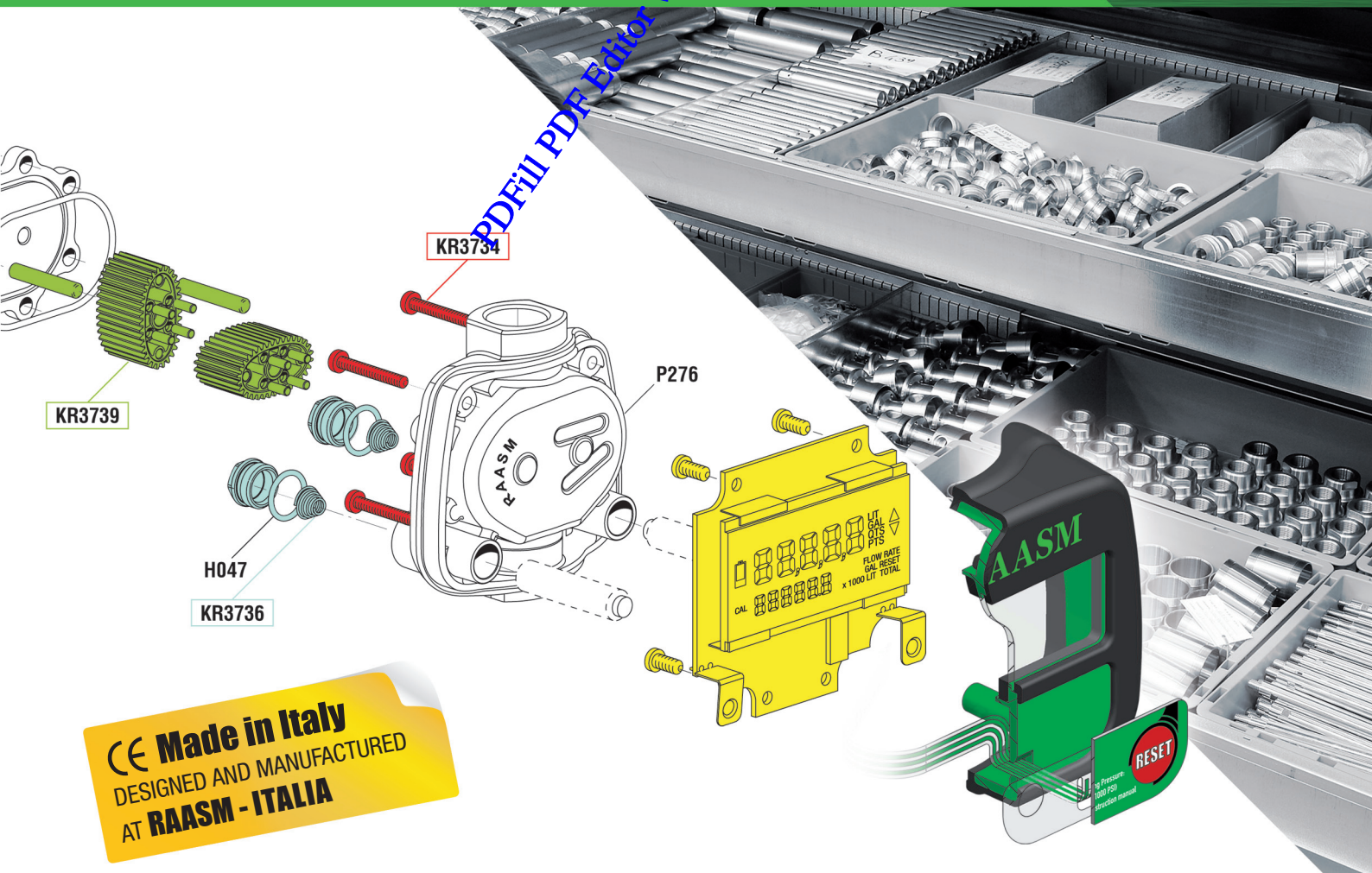

technology
quality
functionality

CATALOGO RICAMBI SPARE PARTS CATALOGUE N° 105/2011



PDFFill PDF Editor with Free Writer and Tools

CE Made in Italy
DESIGNED AND MANUFACTURED
AT RAASM - ITALIA

PDFill PDF Editor with Free Writer and Tools



RAASM

FLUIDS AND LUBRICATION EQUIPMENT



technology
quality
functionality

CATALOGO RICAMBI - SPARE PARTS CATALOGUE

PDF Editor with Free Writer and Tools



FLUIDS AND LUBRICATION EQUIPMENT



INTRODUZIONE

Il presente catalogo facilita la consultazione e l'ordinazione dei ricambi ai nostri rivenditori ed utilizzatori. I componenti di ogni singolo articolo sono stati raggruppati in kits che abbiamo chiamato KR (= Kit Ricambio)

Questa gestione della ricambistica ha permesso l'abbattimento dei costi a favore del prezzo finale.

I particolari ordinabili singolarmente però, anche se facenti parte dei kits KR, avranno un prezzo maggiore dovuto alla notevole incidenza dei costi di gestione.

NOTA

In fase di ordinazione suggeriamo di tenere presente che un kit può essere comune a più articoli. Sapendo ciò potete evitare l'ordinazione di ricambi che diventerebbero dei doppioni inutili.

Es. il KR 6201 é lo stesso per tutte le pompe grasso 50:1 e 65:1

Es. il KR 4302 é lo stesso per tutti gli aspiratori d'olio.

Vedi tabella kit ricambi ed articolo o articoli di appartenenza.



INTRODUCTION

The present catalogue allows our retailers and users to determine and order relevant spare parts.

The components of any single model have been grouped in kits which we call KR (= spare parts kits).

This arrangement has enabled us to be able to offer these repair kits at a very competitive price.

Due to management costs, individual spare parts which are available separately, will be priced at a premium.

NOTE

When ordering spare parts, please note that one kit can be common to different models. This will avoid ordering unnecessary parts and keep stock holding to a minimum.

E.g. The KR 6201 is the same for all the grease pumps 50:1 and 65:1.

E.g. The KR 4302 is the same for all the oil extracting devices.

Refer to separate list of spare part kits and models where used.



INTRODUCTION

Ce catalogue a comme but de faciliter la consultation et la commande des pièces détachées à nos revendeurs et utilisateurs. Les pièces qui composent chaque appareil ont été groupées en KITS que nous appellerons KR (=Kit Rechange).

Cette gestion des pièces détachées a permis la réduction des couts en faveur du prix final. Les pièces détachées, de toute façon, qui peuvent être commandées singulièrement, même si elles font partie d'un kit KR, ont un prix supérieur à cause des différentes couts de gestion.

NOTE

En phase de commande nous vous prions de faire attention au fait qu'un kit peut être comun à plusieurs appareils. Vous pourriez de cette façon, éviter la commande de pièces doubles et inutilis.

Ex. Le Kit KR 6201 est le même pour toutes les pompes à graisse 50:1 et 65:1

Ex. Le KR 4302 est le même pour tous les aspirateurs d'huile.

Voir tableau des kits de rechange et appareil ou appareils auxquels ils appartiennent.



ANLEITUNG

Dieser Katalog erleichtert unseren Händlern und Kunden die Zuordnung und die Bestellung von benötigten Ersatzteilen.

Bei jedem Gerät wurden zusammengehörende Einzelteile in Baugruppen = KR (Kit Ricambi) zusammengefaßt und entsprechend farblich gekennzeichnet. Dies erspart uns Kosten und ermöglicht uns, den KR-Preis zu senken.

Bei Bestellung von Einzelteilen entstehen höhere Kosten und dadurch bedingt auch höhere Einzelpreise.

ANMERKUNG

Bei Bestellung von Ersatzteilen beachten Sie bitte, daß Ersatzteil-Kit KR meistens für mehrere Geräte passen. So können Sie vermeiden, unnötige bzw. ungängige Ersatzteile zu bestellen.

Beispiel: KR 6201 paßt für alle Fettpumpen 50 : 1 und 65 : 1

Beispiel: KR 4302 paßt für alle Absauggeräte.

Siehe Tabelle KR Ersatzteil - Kit und die dafür passenden Geräte.



ISTRUCCIONES

El presente catálogo facilita las consultas y ordenación de los recambios a nuestros clientes y usuarios. Los componentes de cada artículo especial han sido reagrupados en kits que hemos llamado KR (=Kit Recambio).

Esta gestión de la suministradora de recambios permite el abaratamiento de los costes a favor del precio final.

NOTA

En fase de pedido sugerimos tener presente que un kit puede ser comun a varios artículos. Conocinedo esto se puede evitar pedir recambios que resulten inútiles para el uso.

Ej. el KR 6201 es el mismo para todas las bombas de engrase 50:1 a 65:1.

Ej. el KR 4302 es el mismo para todos los aspiradores de aceite.

VER cuadro de Kits de recambios y artículo o artículos de accesorios.



...per rispondere alle Vostre esigenze e alle richieste ricambi



...in order to meet your requirements and the unique request for spare parts



...pour répondre à vos besoins et à vos demandes de pièces de rechange



...die Antwort auf Ihre Ansprüche und Ersatzteilanfragen."



...para responder a vuestras exigencias y a los pedidos de piezas de repuesto"



**tecnologia
qualità
funzionalità**

technology, quality, functionality

GUIDA ALLA LETTURA DEL CATALOGO RICAMBI

Ogni pagina del catalogo segue sempre la stessa impostazione grafica. Per maggiore chiarezza sono stati illustrati, qui di seguito, con breve descrizione, i vari blocchi che compongono le varie pagine.

GUIDE TO THE SPARE PARTS CATALOGUE

Each page of this catalogue has the same layout. To make things clearer the different sections which comprise the pages are shown here together with a short description.

GUIDE DE LECTURE DU CATALOGUE DES PIECES DETACHEES

Chaque page du catalogue suit toujours la même plan et la même organisation. Pour faciliter la lecture de ce catalogue, nous vous présentons ci-dessous, de manière succincte, les différentes parties dont la page se compose.

AUFBAU DES ERSATZTEIL-KATALOGES

Jede Produktseite dieses Kataloges ist identisch aufgebaut. Wir möchten Ihnen hier kurz diesen Aufbau erläutern.

GUIA DE LECTURA DEL CATALOGO DE RECAMBIOS

Cada página del catálogo sigue siempre el mismo planteamiento gráfico. Para mayor claridad existen ilustraciones con descripciones breves de varios bloques que componen las diferentes páginas.



Vista esplosa



Exploded view



Vue éclatée





Explosionsansicht



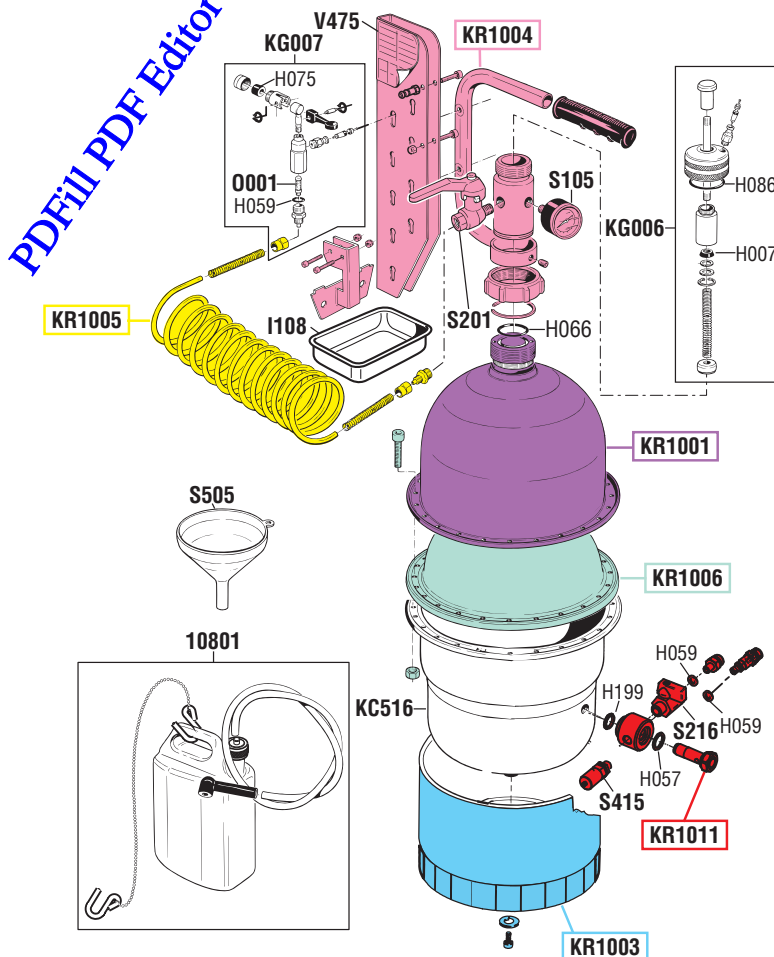

Dibujo desarrollado





 Elenco dei KR (kit ricambio) in cui l'articolo è suddiviso. Ogni KR (es. KR1004) include un gruppo ben definito ed omogeneo di particolari. Un kit KR può essere comune a più articoli.

 List of KR (spare part kits) into which the item has been subdivided. Each KR includes a well selected and related group of parts. Remember that a KR can be common to different models.

 Liste des KR (Kit Rechange) des diverses parties de l'appareil. Chaque KR groupe un nombre bien déterminé et homogène de pièces. Nous vous rappelons qu'un KR peut être commun à plusieurs appareils.

 Liste der für das jeweilige Gerät zusammengefaßten Baugruppen (Kit KR). Jeder Kit (KR) enthält exakt abgestimmte Einzelteile, die funktionell zusammengehören. Denken Sie daran, daß jeder Kit "KR" meistens für mehrere Geräte verwendet werden kann

 Catálogo de KR (Kit Recambio) en que cada artículo esta subdividido. Cada KR comprende un grupo bien definido y homogéneo de particularidades. Un Kit KR puede ser común para diferentes artículos

 Elenco particolari dell'articolo fornibili singolarmente.

 List of spare parts which can be supplied separately.

 Liste des pièces qui peuvent être commandées séparément.

 Liste der Ersatzteile, die einzeln erhältlich sind.

 Catálogo especial de artículos suministrados independientemente.

 Il kit guarnizioni (es. KR1050) comprende tutte le guarnizioni utilizzate nell'articolo. Questo kit non è né menzionato, né evidenziato nell'esploso. (Le guarnizioni sono fornibili anche singolarmente)

 A gasket kit includes all the gaskets and "O" rings used on the model. This kit is not mentioned or shown in the exploded view. The seals can also be supplied individually

 Le kit de joints comprend tous les joints utilisés dans l'appareil. Ce kit n'est ni mentionné, ni mis en évidence dans la vue éclatée. Les garnitures peuvent être fournies même une à la fois.

 Dieser Dichtungsring-Satz enthält alle aufgeführten Dichtungen des Gerätes (nicht in der Explosionszeichnung aufgeführt). Die Dichtungen sind auch einzeln lieferbar

 El kit de aprovisionamiento comprende todos los utilizados en el artículo. Este kit no esta ni mencionado ni desglosado. "Las guarniciones se pueden entregar también individualmente"

KIT RICAMBI		
OGNI KIT SOTTO RIPORTATO COMPRENDE I RICAMBI EVIDENZIATI CON LO STESSO COLORE E LE RELATIVE GUARNIZIONI. QUESTI RICAMBI NON SONO FORNIBILI SEPARATAMENTE TRANNE QUELLI CODIFICATI.		
SPARE PARTS KITS		
EACH KIT SHOWN WITH THE SAME COLOR INCLUDES ALSO THE GASKETS. THE SPARE PARTS INCLUDED IN THE KIT CAN'T BE SUPPLIED SEPARATELY EXCEPT THOSE SHOWN WITH A PROPER CODE.		
CODICE CODE	DESCRIZIONE DESCRIPTION	Q.TÀ QTY
KR1001	CALOTTA SUPERIORE UPPER CAP	1
KR1003	PIEDISTALLO FOOT-STALL	1
KR1004	GRUPPO SUPERIORE COMPLETO COMPLETE UPPER GROUP	1
KR1005	TUBO COLLEGAMENTO CONNECTION HOSE	1
KR1006	MEMBRANA CON SET VITI MEMBRANE WITH SET OF SCREWS	1
KR1011	GRUPPO INFERIORE COMPLETO COMPLETE LOWER GROUP	1

ELENCO RICAMBI FORNIBILI SINGOLARMENTE		
LIST OF SPARE PARTS WHICH CAN BE SUPPLIED SEPARATELY		
CODICE CODE	DESCRIZIONE DESCRIPTION	Q.TÀ QTY
10801	TANICHETTA DI RECUPERO BRAKE FLUID COLLECTION CONTAINER	1
1108	VASCHETTA PORTA OGGETTI TOOL TRAY	1
KC516	SERBATOIO INFERIORE LOWER RESERVOIR	1
KG006	TAPPO CARICA OIL OIL LEVEL INDICATOR	1
KG007	ATTACCO RAPIDO QUICK COUPLER	1
S105	MANOMETRO ø 50 mm GAUGE ø 50 mm	1
S201	RUBINETTO A SFERA 1/4" BALL VALVE 1/4"	1
S216	RUBINETTO A SFERA 1/4" BALL VALVE 1/4"	1
S415	VALVOLA DI SICUREZZA 3 bar SAFETY VALVE 3 bar	1
S505	IMBUTO RECUPERO OLIO FUNNEL	1
475	ETICHETTA ELENCO TAPPI LABEL	1

Art. KR1050		
KIT GUARNIZIONI COMPLETO COMPOSTO DALLE GUARNIZIONI SOTTO ELENCATE JOINTS GASKETS LIST INCLUDING ALL THE GASKETS SHOWN HERE UNDER		
CODICE CODE	DESCRIZIONE DESCRIPTION	Q.TÀ QTY
H007	GUARNIZIONE GASKET	1
H057	O-RING 2062 O-RING 2062	1
H059	O-RING 2037 O-RING 2037	1
H066	O-RING 3118 O-RING 3118	1
H068	O-RING 112 O-RING 112	1
H075	GUARNIZIONE ATTACCO RAPIDO QUICK CONNECTOR GASKET	1
H086	O-RING 4118 O-RING 4118	1
H199	O-RING 119 O-RING 119	1
0001	FILTRO ATTACCO RAPIDO QUICK CONNECTOR FILTER	1

Art. KS1081		
SET RICAMBI CONSIGLIATI AI PUNTI VENDITA E ASSISTENZA, COMPOSTO DAI RICAMBI SOTTO ELENCATI SPARE PARTS KIT ADVISED TO THE REPAIR CENTERS. THIS KIT INCLUDES ALL THE SPARE PARTS SHOWN HERE UNDER		
CODICE CODE	DESCRIZIONE DESCRIPTION	Q.TÀ QTY
KR1006	MEMBRANA CON SET DI VITI MEMBRANE WITH SET OF SCREWS	1
KR1050	KIT GUARNIZIONI COMPLETO COMPLETE GASKETS KIT	1
S105	MANOMETRO ø 50 mm GAUGE ø 50 mm	1

 Un KS (es. KS1080) raggruppa i ricambi (KR o particolari singoli) riportati nelle altre tabelle. Questi sono i ricambi consigliati, dalla ditta costruttrice, ai punti vendita ed assistenza, soprattutto per le prime forniture. Evidentemente un KS non può essere evidenziato nell'esploso.

 A KS includes the spare parts (KR or single parts) as shown in the other tables. A KS includes the spare parts advised by the manufacturer to all stockists and service centres, mostly for the first deliveries. A KS cannot be shown in the exploded view.

 Un KS rassemble les pièces détachées (KR ou pièces particulières reportées dans les autres tableaux), conseillées par le constructeur sur les différents points de vente et assistance, surtout lors des premières livraisons. Il va de soit, qu'un KS ne peut être mis en évidence dans la vue éclatée.

 Dieses Ersatzteile-Set "KS" enthält die aufgeführten Kit KR und Einzelteile, die als Ersatzteil-Grundausrüstung anzusehen sind. Wir empfehlen unseren Händlern bei Erstbestellung von Geräten dieses Set "KS" als Lagerware mitzubestellen. Da das Set "KS" aus Kit KR und Einzelteilen besteht, kann es in der Explosionszeichnung nicht farblich separat dargestellt werden.

 Un KS reagrupa los recambios (KR o Piezas especiales mencionadas en las tablas anteriores) referidos en el otro cuadro. Estos recambios son los aconsejados por la firma productora, los puntos de venta y asistencia sobretodo para el primer proveedor. Evidentemente un KS no puede ser despiezado/ desglosado.



ARTICOLO ARTICLE	PAGINA PAGE	ARTICOLO ARTICLE	PAGINA PAGE	ARTICOLO ARTICLE	PAGINA PAGE
10/50	306	22017	86	33070/A	122-123
10/51	306	22017/N	86	33071	122-123
10/52	306	22024	87	33072	122-123
10/55	306	22024/N	87	33073	122-123
10/56	306	23024	88	33080	124-125
10/57	306	23024/N	88	33081	124-125
10/80	30-31	23025	89	33082	124-125
10/81	32-33	23025/N	89	33083	124-125
10/82	34-35	26090	90-91	33094	120-121
10/85	36-37	26091	90-91	33096	120-121
10105	38	26093	90-91	33120	174
10205	38	26094	90-91	33121	173
10207	38	2B3/16117NH22	114-115	33124	126
10705	39	2B3/16117HH22	114-115	33125	127
10805	39	2B3/16117TT22	114-115	33135	128
10807	39	2B3/16117EA12	114-115	33140	163
11/60	43	2B3/16117SS22	114-115	33146	130
11/61	43	2B8/16117NH22	116-117	33147	130
11/62	43	2B8/16117HH22	116-117	33148	130
11/63	43	2B8/16117TT22	116-117	33150	131
11/64	43	2B8/16117EA12	116-117	33151	131
11/65	43	2B8/16117SS22	116-117	33152	131
11000/W	40	30050	92	33153	131
11001	41	30051	93	33160	132-133
11002	41	30200	94	33161	132-133
11004	42	31200	95	33170	134-135
115D/121	44-45	31201	96	33171	134-135
115D/181	46-47	32016	97	33172	134-135
115D/31	48-49	32024	98	33173	134-135
115D/91	50-51	32065	99	33194	132-133
115DV/31	52-53	32067	100-101	33196	132-133
115F/121	54-55	32068	100-101	33360	136-137
115F/181	56-57	33/101160	102	33396	136-137
115F/401	58-59	33/101260	104	33444	138
115F/751	60-61	33/1511NHH2	104	33445	138
115F/91	62-63	33/2011NHHV2	105-106-107	33446	138
115FSP/751	60-61	33/2011HHHV2	106-107	33500	140-141
116F/121	54-55	33/2011TTPT2	106-107	33505	140-141
116F/181	56-57	33/2011EDDF2	106-107	33550	142
116F/401	58-59	33/2011SDDF2	106-107	33710	143
116F/751	64-65	33/2511NHH2	102	3C3/2611NHH2	112-113
117F/401	58-59	33/2611NHHV2	108-109	3C3/2611HHH2	112-113
117F/751	64-65	33/2611HHHV2	108-109	3C3/2611TTP2	112-113
118F/401	66-67	33/2611TTPTV2	108-109	3C3/2611EAA2	112-113
118FSP/401	66-67	33/2611EDDF2	108-109	3C3/2611SSS2	112-113
120D/91	68-69	33/2611SDDF2	108-109	35060	144-145
150D/41	70-71	33/3011NHHV2	103-110-111	35061	144-145
150D/61	72-73	33/3011HHHV2	110-111	35063	144-145
150DV/61	74-75	33/3011TTPT2	110-111	35076	144-145
150F/701	76-77	33/3011EDDF2	110-111	35094	144-145
151F/701	76-77	33/3011SDDF2	110-111	35160	146-147
152F/701	76-77	33016	118	35161	146-147
153F/701	78-79	33024	119	35163	146-147
153FSP/701	78-79	33060	120-121	35173	146-147
180D/51	80-81	33060/A	120-121	35176	146-147
180D/81	82-83	33061	120-121	35179	148-149
180DV/81	84-85	33070	122-123	35180	148-149

PDFfill PDF Editor With Free Writer and Tools



ARTICOLO ARTICLE	PAGINA PAGE
35194	146-147
35196	146-147
35265	150-151
35270	150-151
36060	152-153
36061	152-153
36063	152-153
36073	152-153
36076	152-153
36094	152-153
36096	152-153
36601	154
36602	154
36603	154
36604	154
36641	154
37650	150-154
37670	150-154
37681	155
37683	155
37686	156
37687	156
37688	157
37689	157
37690	157
37691	156
37692	158
37697	159
37698	159
37703	160
37728	161
37729	161
37730	161
37740	162
37741	162
37742	162
37743	162
37750	163
37751	163
37752	163
37758	164
37759	164
37760	164
37762	165
37764	165
37775	166
37776	166
37777	166
37778	166
37780	167
37781	168
37785	169
37786	170
37787	170
37788	170
37794	171
37795	171

ARTICOLO ARTICLE	PAGINA PAGE
37796	171
37797	172
37798	172
37799	172
38020	173
38021	173
38022	173
38023	161-174
38024	174
38025	174
38097	175
38098	176
39304	177
39307	178
39314	179
39317	180
39320	181
39321	182
39322	183
39323	184
39324	185
39328	186
39334	187
39335	188
39336	189
39338	190
39340	191
39351	192
39352	193
39421	194
39422	195
42000	196
42050	197
42055	198
42056	199
42059	200
42060	200
42061	201
42062	201
42063	202
42064	202
42065	203
42066	204
42069	205
42070	205
42072	206
42073	206
42075	207
42076	208
42088	209
42089	209
42090	210
42091	211
42092	212
42101	213
42102	213
42103	214

ARTICOLO ARTICLE	PAGINA PAGE
42113	215
42114	215
42115	216
42116	217
42160	218-219
42164	220-221
42170	222
42215	224-225
43016	226
43024	227
43060	228-229
43065	230-231
43090	232-233
43091	234-235
43114	236-237
43115	238-239
43116	240
43190	242-243
43724	244
43760	245
43765	246-247
43790	248-249
44060	250-251
44065	252-253
44066	254-255
44067	256-257
44090	258-259
44091	260-261
44092	262-263
44093	264-265
44115	266-267
44116	268-269
44117	270-271
44118	272-273
45100	274
45110	275
45111	275
45150	276
45180	277
45200	278
45250	279
45280	280
45300	281
45310	282
45311	282
46064	283
46065	284-285
46114	286-287
46115	288-289
46116	290-291
46215	292-293
52010	294
52013	295
52015	296
52024	297
53016	296
53024	297

PDFill PDF Editor with Free Writer and Tools



ARTICOLO ARTICLE	PAGINA PAGE
60280	298
60310	298
60311	298
60410	299
60411	299
61280	300
61310	300
61311	300
61410	301
61411	301
62041	302-303
62041/A	302-303
62048	302-303
62074	302-303
62095	302-303
63041	304-305
63048	304-305
63074	304-305
63095	304-305
65138	306
65142	306
65160	306
65280	306
65309	307
65310	306
65311	307
65350	306
65385	306
65420	306
65600	306
66855	308
66860	309
66880	310
66881	310
66882	310
66888	309
66889	309
68012	311
68113	312
68213	313
70365	314
73500	316-317
73511	316-317
73512	316-317
735131.60141	316-317
735131.60152	316-317
735131.60252	316-317
735131.60261	316-317
735141.60152	316-317
735141.60252	316-317
7522001.100	318-319
7522001.150	322-323
7522001.200	318-319
7522001.250	322-323
7522001.300	322-323
7522001.400	318-319
7522001.450	322-323
7532001.100	318-319
7532001.150	322-323
7532001.200	318-319
7532001.250	322-323
7532001.300	322-323
7532001.400	318-319
7532001.450	322-323

ARTICOLO ARTICLE	PAGINA PAGE
7552001.100	320-321
7552001.150	324-325
7552001.200	320-321
7552001.250	324-325
7552001.300	324-325
7552001.400	320-321
7552001.450	324-325
7562001.100	320-321
7562001.150	324-325
7562001.200	320-321
7562001.250	324-325
7562001.300	324-325
7562001.400	320-321
7562001.450	324-325
7721001.100	326-327
7721001.400	326-327
7741001.100	326-327
7741001.400	326-327
7751001.100	326-327
7751001.400	326-327
7771001.100	326-327
7771001.400	326-327
7721301.100	328-329
7721301.400	328-329
7741301.100	328-329
7741301.400	328-329
7751301.100	328-329
7751301.400	328-329
7771301.100	328-329
7771301.400	328-329
7721601.100	330-331
7721601.400	330-331
7741601.100	330-331
7741601.400	330-331
7751601.100	330-331
7751601.400	330-331
7771601.100	330-331
7771601.400	330-331
7721801.100	332-333
7721801.400	332-333
7741801.100	332-333
7741801.400	332-333
7751801.100	332-333
7751801.400	332-333
7771801.100	332-333
7771801.400	332-333
7721901.100	334-335
7721901.400	334-335
7741901.100	334-335
7741901.400	334-335
7751901.100	334-335
7751901.400	334-335
7771901.100	334-335
7771901.400	334-335
77/12775	336-337
77/14175	336-337
77/15575	336-337
77/16975	336-337
77/12775B	336-337
77/14175B	336-337
77/15575B	336-337
77/16975B	336-337
77/22775	336-337
77/24175	336-337

ARTICOLO ARTICLE	PAGINA PAGE
77/25575	336-337
77/26975	336-337
77/22775B	336-337
77/24175B	336-337
77/25575B	336-337
77/26975B	336-337
77/32775	336-337
77/34175	336-337
77/35575	336-337
77/36975	336-337
77/32775B	336-337
77/34175B	336-337
77/35575B	336-337
77/36975B	336-337
80035	338
80040	339
80050	340
80200	341
80201	342
80210	343
80215	344
8288.100	346
8290.100	347
8292.100	348
8328.100	349
8328.105	349
8330.100	350
8330.200	351
8330.300	350
8330.350	352
8330.400	351
8330.500	352
8330.800	354
8332.100	355
8332.300	356
8332.350	356
8332.400	357
8332.500	358
8332.800	359
8378.100	360
8378.105	360
8380.100	361
8380.200	362
8380.300	361
8380.350	363
8380.400	362
8380.500	364
8382.100	365
8382.200	366
8382.300	365
8382.350	367
8382.500	368
8390.100	369
8390.200	370
8390.300	369
8390.350	371
8390.400	370
8390.500	372
8390.800	373
8392.100	374
8392.200	375
8392.300	374
8392.350	376
8392.500	377



ARTICOLO ARTICLE	PAGINA PAGE	ARTICOLO ARTICLE	PAGINA PAGE	ARTICOLO ARTICLE	PAGINA PAGE
8392.800	378	8530.1000	404	8562.106	431
8420.100	379	8530.3000	405	8564.200	430
8420.200	379	8530.4000	404	8564.206	431
8420.300	379	8530.5000	405	8564.300	431
8420.350	379	8532.100	406	8564.350	431
8420.400	379	8532.500	406	8617.100	432
8420.500	379	8532.700	407	8617.200	432
8420.700	380	8532.800	408	8617.400	432
8420.800	381	8534.200	406	8617.500	432
8420.1000	382	8534.300	406	8617.600	433
8422.100	383	8534.350	406	8618.100	434
8422.500	383	8536.200	409	8618.200	434
8424.200	383	8537.200	410	8618.400	434
8424.300	383	8540.100	411	8618.500	434
8424.350	383	8540.105	412	8637.100	435
8430.100	384	8540.200	411	8637.200	435
8430.200	384	8540.205	412	8637.400	435
8430.300	384	8540.300	412	8637.500	435
8430.350	384	8540.350	412	8637.600	436
8430.400	384	8540.400	411	8638.100	437
8430.500	384	8540.405	412	8638.200	437
8430.700	385	8540.500	413	8638.400	437
8430.800	386	8540.700	413	8638.500	437
8430.1000	387	8540.800	414	89010	438
8430.3000	388	8540.5000	415	89011	438
8430.4000	387	8542.100	416	89109	439
8430.5000	388	8542.105	417	89110	439
8432.100	389	8542.500	417	90C/111	440-441
8432.500	389	8542.700	418	90C/51	442-443
8432.700	390	8542.800	419	90C/71	444-445
8432.800	391	8544.200	416	90D/111	446-447
8434.200	389	8544.205	417	90D/21	448-449
8434.300	389	8544.300	417	90D/51	450-451
8434.350	389	8544.350	417	90D/71	452-453
8436.200	392	8545.200	420	90DV/21	454-455
8437.250	393	8549.0100	421	90F/111	456-457
8440.100	394	8549.0110	421	90F/451	458-459
8440.400	394	8550.100	422	90F/51	460-461
8440.500	394	8550.105	423	90F/71	462-463
8450.100	395	8550.200	422	90FSP/451	458-459
8450.400	395	8550.205	423	91C/111	440-441
8450.500	395	8550.300	423	91C/701	464-465
8520.100	396	8550.350	423	91C/71	444-445
8520.200	396	8550.400	422	91F/111	456-457
8520.300	396	8550.405	423	91F/451	466-467
8520.350	396	8550.500	423	91F/71	462-463
8520.400	396	8550.700	424	92C/111	440-441
8520.500	396	8550.800	425	92C/71	444-445
8520.700	397	8552.100	426	92F/451	466-467
8520.800	398	8552.105	427	93C/71	444-445
8522.100	399	8552.500	427	94D/61	468-469
8522.500	399	8554.200	426	95D/61	468-469
8524.200	399	8554.205	427	9430.100	470
8524.300	399	8554.300	427	9430.200	470
8524.350	399	8554.350	427	9430.300	470
8530.100	400	8560.100	428	9430.400	470
8530.200	400	8560.106	429	9430.500	470
8530.300	400	8560.200	428	9432.100	471
8530.350	400	8560.206	429	9432.500	471
8530.400	400	8560.300	429	9434.200	471
8530.500	400	8560.350	429	9434.300	471
8530.600	401	8560.400	428	9450.100	472
8530.700	402	8560.406	429	9450.400	472
8530.800	403	8562.100	430	9450.500	472

PDFill PDF Editor with Free Writer and Tools



Tabella kit ricambi ed articolo o articoli di appartenenza
List of spare parts kits and item or items to which they fit



Tableau des kits de rechange de l'appareil ou des appareils auxquels ils appartiennent
Liste der ersatzteil kit und die dafür passenden geräte



Lista de recambios y accesorios

CODICE - CODE	ARTICOLI - ARTICLE
KR10/01	10/85
KR10/02	10/80-10/81-10/82-10/85
KR10/03	10/85
KR10/04	10/85
KR10/05	10/85
KR10/06	10/80-10/82-10/85
KR10/07	10/85
KR10/08	10/80-10/81-10/82
KR10/09	10/82
KR10/10	10/80-10/81
KR10/11	10/80-10/81-10/82
KR10/12	10/80-10/81-10/82
KR10/13	10/80-10/81
KR10/14	10/82
KR1001	10105-10205-10207-10705-10805-10807
KR1002	10705-10805-10807
KR1003	10105-10205-10207-10705-10805-10807
KR1004	10105-10205-10207-10705-10805-10807
KR1005	10105-10205-10207-10705-10805-10807
KR1006	10105-10205-10207-10705-10805-10807
KR1007	10705-10805-10807
KR1008	11000/W
KR1009	11000/W
KR1010	11000/W
KR1011	10105-10205-10207
KR1012	11004
KR1013	11004
KR1050	10105-10205-10207-10705-10805-10807
KR1101	10/80-10/81-10/82-10/85
KR1102	10/80-10/81-10/82-10/85
KR2201	22017-22017/N-32016-33016-43016-43116
KR2202	22024-22024/N-23024-23024/N-23025-23025/N-32024-33024-43024-43724-52024-53024-68113-68213-80050
KR2203	22017-22017/N-22024-22024/N-23024-23024/N-23025-23025/N-33016-33024-35265-35270-37650-37670-42066-42091-42116-46064-46114
KR2204	22024-22024/N-33024
KR2205	22017-22017/N-22024-22024/N-23024-23024/N-23025-23025/N
KR2208	22024-22024/N-23024-23024/N-23025-23025/N-32024-33024-43024-43724
KR2209	22017-22017/N-33016
KR2210	23024-23024/N-23025-23025/N
KR2211	43016-43024-43116-43724
KR2250	22017-22017/N-22024-22024/N-23024-23024/N-23025-23025/N
KR2601	26090-26091-26093-26094
KR2602	26090-26091-26093-26094
KR2603	26090-26091-26093-26094-35060-35061-35063-35076-35094
KR2604	26090-26091-26093-26094
KR2650	26090-26091-26093-26094-35060-35061-35063-35076-35094
KR2651	26090-26091-26093-26094
KR3101	31200
KR3103	31201
KR3150	31200-31201
KR3202	32065-32067-32068-35265-35270-37650-37670-42063-42064-42065-42066-42072-42073-42088-42089-42090-42091-42092-42101-42102-42103-42113-42114-42115-42116-42160-42164-43060-43065-43090-43091-43114-43115-43190-43760-43765-43790-44060-44065-44066-44067-44090-44091-44092-44093-44115-44116-44117-44118-46064-46065-70365
KR3203	32065-32067-32068-35265-35270-37650-37670-42063-42064-42065-42066-42072-42073-42088-42089-42090-42091-42092-42160-42164-43060-43065-43090-43091-43190-43760-43765-43790-44060-44065-44066-44067-44090-44091-44092-44093-46064-46065-70365
KR3204	32065-32067-32068-35265-35270-37650-37670-42063-42064-42065-42066-42160-42164-43060-43065-43760-43765-44060-44065-44066-44067-46064-46065-70365
KR3205	32065-35265-35270-37650-37670-70365

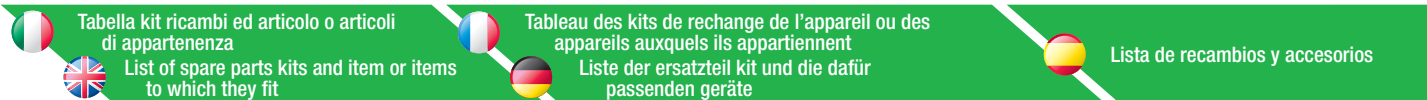

CODICE - CODE	ARTICOLI - ARTICLE
KR3208	30051-32067-32068
KR3209	30050-30051-30200-32016-32024-32065-32067-32068
KR3210	30050-30051-30200
KR3214	31200-31201
KR3250	30050-30051-30200
KR3251	32016-32024-32065-32067-32068
KR33/04	33/2011NHHV2-33/2011TTPT2-33/2011HHHV2-33/2011EDDF2-33/2011SDDF2-2B3/16117NH22-2B3/16117HH22-2B3/16117EA12-2B3/16117SS22-2B3/16117TT22-2B8/16117NHH2-2B8/16117HH22-2B8/16117EA12-2B8/16117SS22-2B8/16117TT22-33500-33505
KR33/05	33/2011NHHV2-33/2011HHHV2-33500-33505
KR33/06	33/2011NHHV2-33500-33505
KR33/09	33/2011NHHV2-33/2011HHHV2-33/2011TTPT2-33/2011EDDF2-33/2011SDDF2-33500-33505
KR33/10	33/2011NHHV2-33/2011HHHV2-33/2011TTPT2-33/2011EDDF2-33/2011SDDF2-33/2611NHHV2-33/2611HHHV2-33/2611TTPT2-33/2611EDDF2-33/2611SDDF2-3C3/2611NHH2-3C3/2611HHH2-3C3/2611TTPT2-3C3/2611EAA2-3C3/2611SSS2-2B3/16117NH22-2B3/16117HH22-2B3/16117EA12-2B3/16117SS22-2B3/16117TT22-2B8/16117NHH2-2B8/16117HH22-2B8/16117EA12-2B8/16117SS22-2B8/16117TT22-33500-33505
KR33/11	33500-33505
KR33/15	150D/41-150D/61-150DV/61-150F/701-151F/701-152F/701-153F/701-153FSP/701-180D/51-180D/81-180DV/81-33/3011NHHV2-33/3011HHHV2-33/3011TTPT2-33/3011EDDF2-33/3011SDDF2
KR33/16	33/3011NHHV2-33/3011HHHV2
KR33/17	33/3011NHHV2
KR33/19	33/3011NHHV2-33/3011HHHV2-30/3011TTPT2-33/3011EDDF2-33/3011SDDF2
KR33/20	33/3011NHHV2-33/3011HHHV2-30/3011TTPT2-33/3011EDDF2-33/3011SDDF2
KR33/21	33/3011NHHV2-33/3011HHHV2-30/3011TTPT2-33/3011EDDF2-33/3011SDDF2
KR33/22	33/3011NHHV2-33/3011HHHV2-30/3011TTPT2-33/3011EDDF2-33/3011SDDF2
KR33/23	33/2011NHHV2-33/2011HHHV2-33/2011TTPT2-33/2011EDDF2-33/2011SDDF2
KR33/24	33/3011NHHV2-33/3011HHHV2-30/3011TTPT2-33/3011EDDF2-33/3011SDDF2
KR33/26	33550-45300-45310-45311
KR33/27	33/2011NHHV2-33/2011HHHV2-33/2011TTPT2-33/2011EDDF2-33/2011SDDF2-33/2611NHHV2-33/2611HHHV2-33/2611TTPT2-33/2611EDDF2-33/2611SDDF2-3C3/2611NHH2-3C3/2611HHH2-3C3/2611TTPT2-3C3/2611EAA2-3C3/2611SSS2-2B3/16117NH22-2B3/16117EA12-2B3/16117SS22-2B3/16117TT22-2B8/16117NHH2-2B8/16117HH22-2B8/16117EA12-2B8/16117SS22-2B8/16117TT22-33500-33505
KR33/30	33/2011NHHV2-33/2011HHHV2-33/2011TTPT2-33/2011EDDF2-33/2011SDDF2-2B3/16117NH22-2B3/16117HH22-2B3/16117EA12-2B3/16117SS22-2B3/16117TT22-2B8/16117NHH2-2B8/16117HH22-2B8/16117EA12-2B8/16117SS22-2B8/16117TT22-33500-33505
KR33/31	33/2011NHHV2-33/2011HHHV2-33/2011TTPT2-33/2011EDDF2-33/2011SDDF2-2B3/16117NH22-2B3/16117HH22-2B3/16117EA12-2B3/16117SS22-2B3/16117TT22-2B8/16117NHH2-2B8/16117HH22-2B8/16117EA12-2B8/16117SS22-2B8/16117TT22-33500-33505
KR33/35	33/3011NHHV2-33/3011HHHV2-30/3011TTPT2-33/3011EDDF2-33/3011SDDF2
KR33/36	33/2611NHHV2-33/2611HHHV2-33/2611TTPT2-33/2611EDDF2-33/2611SDDF2-3C3/2611NHH2-3C3/2611HHH2-3C3/2611TTPT2-3C3/2611EAA2-3C3/2611SSS2
KR33/37	33/2611NHHV2-33/2611HHHV2-33/2611TTPT2-33/2611EDDF2-33/2611SDDF2-3C3/2611NHH2-3C3/2611HHH2-3C3/2611TTPT2-3C3/2611EAA2-3C3/2611SSS2
KR33/48	2B3/16117NH22-2B3/16117HH22-2B3/16117EA12-2B3/16117SS22-2B3/16117TT22-2B8/16117NHH2-2B8/16117HH22-2B8/16117EA12-2B8/16117SS22-2B8/16117TT22
KR33/49	2B3/16117NH22-2B3/16117HH22-2B3/16117EA12-2B3/16117SS22-2B3/16117TT22-2B8/16117NHH2-2B8/16117HH22-2B8/16117EA12-2B8/16117SS22-2B8/16117TT22
KR33/54	33500-33505
KR33/58	33500-33505
KR33/59	33500-33505
KR33/71	33/2011SDDF2
KR33/72	33/2011HHHV2
KR33/73	33/2011TTPT2
KR33/74	33/2011EDDF2
KR33/75	33/2011SDDF2
KR33/76	33/2011NHHV2-33500-33505
KR33/78	33/3011NHHV2
KR33/79	33/3011TTPT2
KR33/80	33/3011HHHV2
KR33/81	33/3011EDDF2
KR33/82	33/3011SDDF2
KR33/101	33/2011TTPT2
KR33/102	33/2011HHHV2

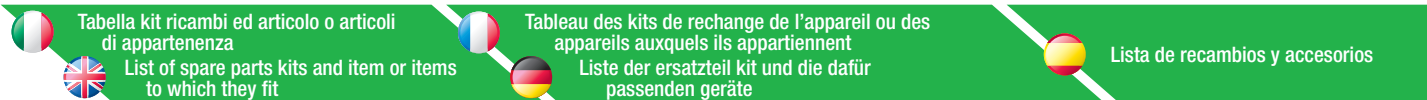

CODICE - CODE	ARTICOLI - ARTICLE
KR33/103	33/2011SDDF2
KR33/104	33/2011EDDF2
KR33/105	33/2011TTPT2
KR33/107	33/2011EDDF2
KR33/109	33/3011TTPT2
KR33/110	33/3011HHHV2
KR33/111	33/3011SDDF2
KR33/112	33/3011EDDF2
KR33/113	33/3011TTPT2
KR33/115	33/3011EDDF2
KR33/119	33/3011SDDF2
KR33/120	2B3/16117NH22-2B8/16117NH22
KR33/121	2B3/16117TT22-2B8/16117TT22
KR33/122	2B3/16117HH22-2B8/16117HH22
KR33/123	2B3/16117EA12-2B8/16117EA12
KR33/124	2B3/16117SS22-2B8/16117SS22
KR33/125	2B3/16117NH22-2B3/16117HH22-2B8/16117NH22-2B8/16117HH22
KR33/126	2B3/16117TT22-2B8/16117TT22
KR33/127	2B3/16117EA12-2B8/16117EA12
KR33/128	2B3/16117SS22-2B8/16117SS22
KR33/205	33/2011NHHV2-33/2011HHHV2-33/2011TTPT2-33/2011EDDF2-33/2011SDDF2-33/2611NHHV2-33/2611HHHV2-33/2611TTPT2-33/2611EDDF2-33/2611SDDF2-3C3/26111NHH2-3C3/26111HHH2-3C3/26111TTP2-3C3/26111EAA2-3C3/26111SSS2-2B3/16117NH22-2B3/16117HH22-2B3/16117EA12-2B3/16117SS22-2B3/16117TT22-2B8/16117NH22-2B8/16117HH22-2B8/16117EA12-2B8/16117SS22-2B8/16117TT22-33500-33505
KR33/206	33/2011NHHV2-33/2011HHHV2-33/2011TTPT2-33/2011EDDF2-33/2011SDDF2-33/2611NHHV2-33/2611HHHV2-33/2611TTPT2-33/2611EDDF2-33/2611SDDF2-3C3/26111NHH2-3C3/26111HHH2-3C3/26111TTP2-3C3/26111EAA2-3C3/26111SSS2-2B3/16117NH22-2B3/16117HH22-2B3/16117EA12-2B3/16117SS22-2B3/16117TT22-2B8/16117NH22-2B8/16117HH22-2B8/16117EA12-2B8/16117SS22-2B8/16117TT22-33500-33505
KR33/209	33/2011NHHV2-33/2011HHHV2-33/2011TTPT2-33/2011EDDF2-33/2011SDDF2-33/2611NHHV2-33/2611HHHV2-33/2611TTPT2-33/2611EDDF2-33/2611SDDF2-3C3/26111NHH2-3C3/26111HHH2-3C3/26111TTP2-3C3/26111EAA2-3C3/26111SSS2-2B3/16117NH22-2B3/16117HH22-2B3/16117EA12-2B3/16117SS22-2B3/16117TT22-2B8/16117NH22-2B8/16117HH22-2B8/16117EA12-2B8/16117SS22-2B8/16117TT22
KR33/210	33/2011NHHV2-33/2011HHHV2-33/2011TTPT2-33/2011EDDF2-33/2011SDDF2-2B3/16117NH22-2B3/16117HH22-2B3/16117EA12-2B3/16117SS22-2B3/16117TT22-2B8/16117NH22-2B8/16117HH22-2B8/16117EA12-2B8/16117SS22-2B8/16117TT22
KR33/211	33/2611NHHV2-33/2611HHHV2-33/2611TTPT2-33/2611EDDF2-33/2611SDDF2-3C3/26111NHH2-3C3/26111HHH2-3C3/26111TTP2-3C3/26111EAA2-3C3/26111SSS2
KR33/212	33/2611NHHV2-33/2611HHHV2-33/2611TTPT2-33/2611EDDF2-33/2611SDDF2-3C3/26111NHH2-3C3/26111HHH2-3C3/26111TTP2-3C3/26111EAA2-3C3/26111SSS2
KR33/213	33/2611NHHV2-33/2611HHHV2-33/2611TTPT2-33/2611EDDF2-33/2611SDDF2
KR33/214	33/2611NHHV2-33/2611HHHV2
KR33/216	33/2611TTPT2-3C3/26111TTP2
KR33/218	33/2611HHHV2-3C3/26111HHH2
KR33/219	33/3011NHHV2-33/3011HHHV2-33/3011TTPT2-33/3011EDDF2-33/3011SDDF2
KR33/220	33/2611EDDF2-3C3/26111EAA2
KR33/223	33/2611SDDF2-3C3/26111SSS2
KR33/229	33/3011NHHV2-33/3011HHHV2-33/3011TTPT2-33/3011EDDF2-33/3011SDDF2
KR33/234	33/2611NHHV2-33/2611HHHV2-33/2611TTPT2-33/2611EDDF2-33/2611SDDF2
KR33/235	33/2611NHHV2-33/2611HHHV2-3C3/26111NHH2-3C3/26111HHH2
KR33/236	33/2611TTPT2-3C3/26111TTP2
KR33/237	33/2611EDDF2-3C3/26111EAA2
KR33/238	33/2611SDDF2-3C3/26111SSS2
KR33/239	33/2611NHHV2-3C3/26111NHH2
KR33/240	33/2611TTPT2-3C3/26111TTP2
KR33/241	33/2611EDDF2-3C3/26111EAA2

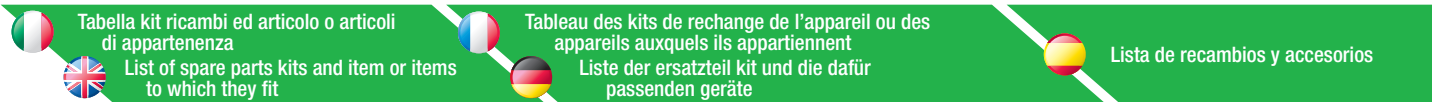

CODICE - CODE	ARTICOLI - ARTICLE
KR33/242	33/2611SDDF2-3C3/26111HHH2
KR33/243	33/2611HHHV2-3C3/26111HHH2
KR33/258	33/3011NHHV2-33/3011HHHV2-33/3011TTPT2-33/3011EDDF2-33/3011SDDF2
KR33/274	33/3011NHHV2-33/3011HHHV2-33/3011TTPT2-33/3011EDDF2-33/3011SDDF2
KR33/275	2B3/16117NH22-2B8/16117NH22
KR33/276	2B3/16117TT22-2B8/16117TT22
KR33/277	2B3/16117HH22-2B8/16117HH22
KR33/278	2B3/16117EA12-2B8/16117EA12
KR33/279	2B3/16117SS22-2B8/16117SS22
KR33/285	3C3/26111NHH2-3C3/26111HHH2-3C3/26111TTP2-3C3/26111EAA2-3C3/26111SSS2
KR3301	33016-33024
KR3302	33060-33060/A-33061-33094-33096-33070-33070/A-33071-33072-33073-33080-33081-33082-33083-33360-33396-35160-35161-35163-35173-35176-35194-35196-35179-35180-62041-62041/A-62048-62074-62095
KR3303	33060-33060/A-33061-33094-33096-33070-33070/A-33071-33072-33073-33080-33081-33082-33083
KR3304	33060-33060/A-33061-33094-33096-33070-33070/A-33071-33072-33073-33080-33081-33082-33083-33160-33161-33194-33196-33170-33171-33172-33173-33360-33396-35160-35161-35163-35173-35176-35194-35196-35179-35180-36060-36061-36063-36073-36076-36094-36096-62041-62041/A-62048-62074-62095-63041-63048-63074-63095
KR3305	33060-33060/A-33061-33094-33096-33070-33070/A-33071-33072-33073-33080-33081-33082-33083-33125-33160-33161-33194-33196-33170-33171-33172-33173-33360-33396-35160-35161-35163-35173-35176-35194-35196-35179-35180-36060-36061-36063-36073-36076-36094-36096-62041-62041/A-62048-62074-62095
KR3306	33060-33060/A-33061-33094-33096-33070-33070/A-33071-33072-33073-33080-33081-33082-33083-33125-33160-33161-33194-33196-33170-33171-33172-33173-33360-33396-35160-35161-35163-35173-35176-35194-35196-35179-35180-36060-36061-36063-36073-36076-36094-36096-62041-62041/A-62048-62074-62095-63041-63048-63074-63095
KR3307	33060-33060/A-33061-33094-33096-33070-33070/A-33071-33072-33073-33080-33081-33082-33083-33160-33161-33194-33196-33170-33171-33172-33173-33360-33396-35160-35161-35163-35173-35176-35194-35196-35179-35180-36060-36061-36063-36073-36076-36094-36096-62041-62041/A-62048-62074-62095-63041-63048-63074-63095
KR3308	33172-33173-33194-33196-35173-35176-35194-35196-36073-36076-36094-36096
KR3309	33072-33073-33082-33083-33094-33096
KR3310	33160-33161-33194-33196
KR3311	33060-33060/A-33061-33094-33096-33160-33161-33194-33196
KR3312	33060-33060/A-33061-33094-33096-33080-33081-33082-33083
KR3313	33070-33070/A-33071-33072-33073
KR3314	33070-33070/A-33071-33072-33073-33170-33171-33172-33173
KR3316	33170-33171-33172-33173
KR3318	33080-33081-33082-33083
KR3319	33360-33396
KR3320	33360-33396
KR3321	33360-33396
KR3350	33016-33024
KR3351	33060-33060/A-33061-33094-33096
KR3352	33160-33161-33194-33196
KR3353	33360-33396
KR3354	33080-33081-33082-33083
KR3355	33070-33070/A-33071-33072-33073-33125
KR3356	33170-33171-33172-33173
KR3357	33135-35060-35061-35063-35076-35094
KR3358	33124-26090-26091-26093-26094
KR3501	35060-35061-35063-35076-35094
KR3502	35060-35061-35063
KR3503	35076-35094
KR3504	35179-35180
KR3505	35179-35180
KR3550	35160-35161-35163-35173-35176-35194-35196
KR3551	35060-35061-35063-35076-35094
KR3552	35179-35180

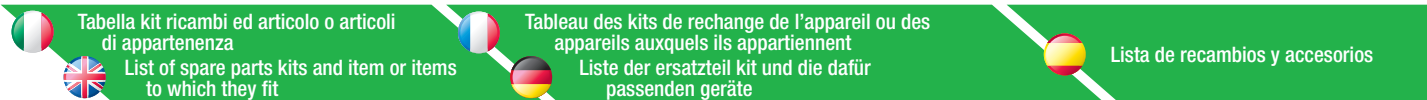

CODICE - CODE	ARTICOLI - ARTICLE
KR3601	33160-33161-33194-33196-33170-33171-33172-33173-36060-36061-36063-36073-36076-36094-36096
KR3602	33160-33161-33194-33196-33170-33171-33172-33173-36060-36061-36063-36073-36076-36094-36096
KR3603	33160-33161-33194-33196-33170-33171-33172-33173-36060-36061-36063-36073-36076-36094-36096
KR3604	35160-35161-35163-35173-35176-35194-35196-36060-36061-36063-36073-36076-36094-36096
KR3605	35160-36060
KR3650	36060-36061-36063-36073-36076-36094-36096
KR3701	37681-37683-37686-37687-37691-37688-37689-37690-37692-37697-37698
KR3702	37681-37683-37686-37687-37691-37688-37689-37690-37692-37697-37698
KR3703	37681-37683-37686-37687-37691-37688-37689-37690-37692-37697-37698
KR3706	37703
KR3709	37728-37729-37730-38023-38024-38025-33120
KR3710	35265-35270-37650-37670-42092
KR3712	37686-37687-37691-37688-37689-37690-37692
KR3713	37686-37687-37691-37688-37689-37690-37692
KR3716	33445-33446-37740-37741-37742-37743-37758-37759-37760-37762-37764-37786-37787-37788-38020-38021-38022-33121
KR3718	37686-37687-37691-37688-37689-37690
KR3719	42055-42056-42061-42062-42072-42073-42075-42076
KR3720	33146-33147-33148-33150-33151-33152-33153
KR3721	33146-33147-33148-33150-33151-33152-33153
KR3723	37750-37751-37752-33140-37775-37776-37777-37778-37794-37795-37796-37797-37798-37799
KR3724	37750-37751-37752-33140-37775-37776-37777-37778-37797-37798-37799-37796-37797-37798-37799
KR3725	37728-37729-37730-38023-38024-38025-33120
KR3726	33445-33446-37758-37759-37760-37762-37764-37786-37787-37788-38020-38021-38022-33121
KR3727	37740-37741-37742-37743
KR3730	33445-33446
KR3732	37785
KR3733	37780
KR3734	37780-37781-37785
KR3735	33146-33147-33148-33445-33446-37728-37729-37730-37758-37759-37760-37762-37764-37780-37781-37785-37786-37787-37788-37794-37795-37796-37797-37798-37799
KR3736	37780-37781-37785
KR3737	37781
KR3738	37785
KR3739	37780
KR3740	37781
KR3741	33710
KR3750	37681-37683-37686-37687-37691-37688-37689-37690-37692-37697-37698
KR3751	37703
KR3752	37728-37729-37730-38023-38024-38025-33120
KR3753	37740-37741-37742-37743-37758-37759-37760-37762-37764-37786-37787-37788-38020-38021-38022-33121
KR3755	33146-33147-33148-33150-33151-33152-33153
KR3756	33140-37750-37751-37752-37794-37795-37796
KR3759	37780-37785
KR3760	37775-37776-37777-37778-37781-37797-37798-37799
KR3761	33445-33446
KR3789	33445-33446
KR3803	38098
KR3804	38097-38098
KR3805	38097-38098
KR3901	39304-39307
KR3902	39314-39317-39328
KR3903	39314-39317
KR3904	39314-39317
KR3905	39314-39317
KR3906	39307-39317-39336
KR3907	39314-39317
KR3908	39317



Tabella kit ricambi ed articolo o articoli di appartenenza
List of spare parts kits and item or items to which they fit



Tableau des kits de rechange de l'appareil ou des appareils auxquels ils appartiennent
Liste der ersatzteil kit und die dafür passenden geräte



Lista de recambios y accesorios

CODICE - CODE	ARTICOLI - ARTICLE
KR3909	39314-39317
KR3910	39304-39314-39324-39334
KR3911	39314
KR3912	39304-39307-39324
KR3913	39304-39307
KR3914	39340
KR3915	39307-39336
KR3916	39304-39307
KR3917	39335-39340
KR3918	39304-39324-39334
KR3919	39324-39328
KR3920	39324-39328
KR3921	39328-39338
KR3922	39324-39328
KR3923	39328-39338
KR3924	39328
KR3925	39324-39328-39336-39338-39340
KR3926	39328
KR3927	39324
KR3928	39324
KR3929	39323-39352
KR3930	39352
KR3931	39322-39352
KR3932	39351-39352
KR3933	39322-39351
KR3934	39321-39351
KR3935	36601-36602-36604-36641-39321-39351
KR3936	39320-39321-39322-39323
KR3937	39322-39323
KR3938	39322
KR3939	39320-39321-39322-39323-39336-39338-39340
KR3940	36601-36602-36641-39320-39321
KR3941	39320
KR3943	36601-36602-36641-39320-39321
KR3944	36603-36641
KR3945	39317
KR3946	39314
KR3947	39324-39328
KR3949	39307
KR3950	39304
KR3951	39335
KR3952	39335-39340
KR3953	39336-39338
KR3954	39334
KR3955	39323
KR3956	39334
KR3957	39323-39335-39336-39338-39340
KR3958	39334-39335-39336-39338-39340
KR3959	39334-39335
KR3960	39421-39422
KR3961	39421-39422
KR3962	39421
KR3963	39422
KR4201	30051-32067-32068-42000-42050-42063-42064-42065-42066-42088-42089-42090-42091-42092-42113-42114-42115-42116-42160-44060-44065-44066-44067-44090-44091-44092-44093-44115-44116-44117-44118
KR4202	42063-42064-42065-42088-42089-42090-42113-42114-42115-42160

PDF24 PDF Editor with Free Writer and Tools



Tabella kit ricambi ed articolo o articoli di appartenenza

List of spare parts kits and item or items to which they fit

Tableau des kits de rechange de l'appareil ou des appareils auxquels ils appartiennent

Liste der ersatzteil kit und die dafür passenden geräte

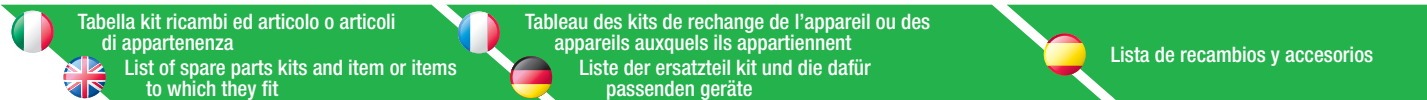
Lista de recambios y accesorios

CODICE - CODE	ARTICOLI - ARTICLE
KR4203	42063-42065-42066-42088-42089-42090-42091-42113-42114-42115-42116-42160-42164-42215-43060-43065-43090-43091-43114-43115-43190-43760-43765-43790-44060-44065-44066-44090-44091-44092-44115-44116-44117-46064-46065-46114-46115-46116-46215
KR4204	42065-42066-42090-42091-42092-42101-42102-42115-42116-42160-42164-42215-43060-43065-43090-43091-43114-43115-43190-43760-43765-43790-44060-44065-44090-44091-44093-44115-44116-44117-44118-46064-46065-46114-46115-46116-46215
KR4205	42065-42066-42090-42091-42092-42115-42116-42160-42164-42215-43060-43065-43090-43091-43114-43115-43190-43760-43765-43790-44060-44065-44090-44091-44093-44115-44116-44117-44118-46064-46065-46114-46115-46116-46215
KR4206	42088-42089-42090-42091-42092-43090-43091-43190-43790-44090-44091-44092-44093
KR4207	42000-42050-42065-42066-42090-42091-42092-42115-42116-42160-44060-44065-44066-44067-44090-44091-44092-44093-44115-44116-44117-44118
KR4208	42000-42050
KR4210	42060
KR4211	42070-42170
KR4212	42069-42070-42170
KR4213	42091-42092-42116
KR4226	42101
KR4227	42101-42102-42103
KR4228	42055-42056-42061-42062
KR4229	42063-42064-42088-42089-42113-42114-44066-44067-44092
KR4230	42064-42089-42114-44067-44093-44118
KR4231	42059
KR4232	42072-42073-42075-42076
KR4233	42101-42102-42103
KR4234	42101-42102-42103
KR4235	42102
KR4236	42069
KR4237	42075-42076
KR4250	42063-42064-42065-42088-42089-42090-42113-42114-42115-42160
KR4251	42000-42050
KR4252	42066-42091-42116
KR4254	42092
KR4301	43016-43024-43116-43724
KR4302	42164-42215-43016-43024-43060-43065-43090-43091-43114-43115-43116-44060-44065-44066-44067-44090-44091-44092-44093-44115-44116-44117-44118-46065-46115-46116-46215
KR4304	42164-42215-43060-43090-43114-43760-43790-44060-44090-44115-46065-46115-46215
KR4305	43065-43091-43115-43765-44065-44066-44067-44091-44092-44093-44116-44117-44118
KR4306	43065-43091-43115-43765-44065-44066-44067-44091-44092-44093-44116-44117-44118-46116
KR4307	43065-43091-43115-43765-44065-44066-44067-44091-44092-44093-44116-44117-44118-46116
KR4308	43065-43091-43115-43765-44065-44066-44067-44091-44092-44093-44116-44117-44118-46116
KR4309	46116
KR4310	43190
KR4311	43190
KR4312	43724-43760-43765-43790
KR4350	43016-43024-43116-43724
KR4351	43060-43090-43114-43760-43790
KR4352	43065-43091-43115-43765
KR4353	43190
KR4401	42066-44060-44065-44066-44067-44090-44091-44092-44093-44115-44116-44117-44118
KR4402	42066-44060-44065-44066-44067
KR4403	42091-42092-42116-44090-44091-44092-44093-44115-44116-44117-44118
KR4450	44060-44090-44115
KR4451	44065-44066-44067-44091-44092-44093-44116-44117-44118
KR4501	45100-45110-45111-45150-45180-45250-45280-45300-45310-45311
KR4502	45100-45110-45111-45150-45180
KR4503	45100-45110-45111-45180-45280-45300-45310-45311
KR4504	45150-45250
KR4505	45100-45110-45111-45150-45180-45250-45280-45300-45310-45311
KR4506	45200-45250-45280



Tabella kit ricambi ed articolo o articoli di appartenenza

List of spare parts kits and item or items to which they fit

Tableau des kits de rechange de l'appareil ou des appareils auxquels ils appartiennent

Liste der ersatzteil kit und die dafür passenden geräte

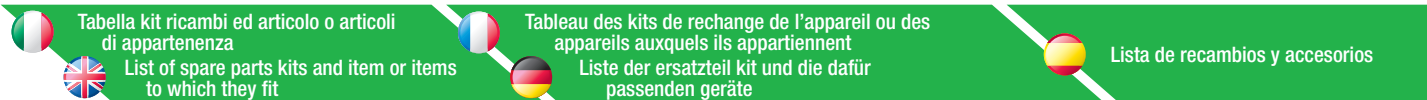
Lista de recambios y accesorios

CODICE - CODE	ARTICOLI - ARTICLE
KR4507	45200-45250-45280
KR4508	45300-45310-45311
KR4509	45100-45110-45111-45150-45180
KR4550	45100-45110-45111-45150-45180
KR4560	45250-45280
KR4561	45200
KR4570	45300-45310-45311
KR4601	42164-46064-46065-46114-46115-46116
KR4602	42164-46064-46065
KR4603	42164-46064-46065-46114-46115-46116
KR4604	42164-46064-46065
KR4605	42164-46065-46115-46116
KR4606	46114-46115-46116
KR4607	42215-46114-46115-46116-46215
KR4608	42113-42114-42115-42116-42215-43114-43115-44115-44116-44117-44118-46114-46115-46116-46215
KR4609	42215-46215
KR4610	42069-42070-42170-42215-46215
KR4611	42215-46215
KR4612	42215-46215
KR4613	42215-46114-46115-46116-46215
KR4614	42101-42102-42103-42113-42114-42115-42116-42215-43114-43115-44115-44116-44117-44118-46114-46115-46116-46215-80200
KR4616	42075-42076
KR4650	46064-46114
KR4651	42164-42215-46065-46115-46215
KR4652	46116
KR5201	52013
KR5202	52013
KR5203	52013
KR5204	52013
KR5205	52013
KR5206	52013-52015-53016
KR5207	52024-53024
KR5208	52015-53016
KR5209	52024-53024
KR5250	52013
KR5251	52015-53016-52024-53024
KR6001	60280-60310-60311-61280-61310-61311
KR6002	60310-61310
KR6003	60280-61280
KR6004	60410-60411-61410-61411
KR6005	60410-61410
KR6006	60410-60411-61410-61411
KR6201	6204 1-62041/A-62048-62074-62095-63041-63048-63074-63095
KR6202	62041-62041/A-62048-62074-62095-63041-63048-63074-63095
KR6203	35160-35161-35163-35173-35176-35194-35196-62041-62041/A-62048-62074-62095-63041-63048-63074-63095
KR6250	62041-62041/A-62048-62074-62095
KR6301	63041-63048-63074-63095
KR6302	63041-63048-63074-63095
KR6350	63041-63048-63074-63095
KR6501	65280-65310-65350-65385-65420-65600
KR6502	65138-65142-65160-10/50-10/51-10/52-10/55-10/56-10/57
KR6503	65309-65311
KR6601	66855-66860-66888-66889-66880-66881-66882
KR6602	66860-66888-66889
KR6604	66855
KR6650	66855
KR6652	66860-66888-66889-66880-66881-66882

PDFfill PDF Editor with Free Writer and Tools



Tabella kit ricambi ed articolo o articoli di appartenenza

List of spare parts kits and item or items to which they fit

Tableau des kits de rechange de l'appareil ou des appareils auxquels ils appartiennent

Liste der ersatzteil kit und die dafür passenden geräte

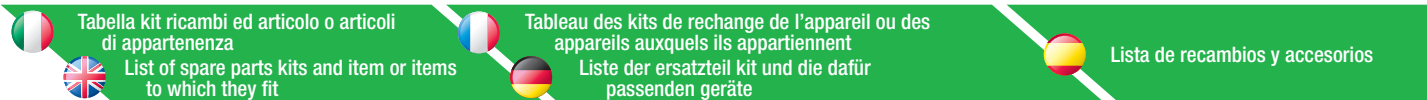
Lista de recambios y accesorios

CODICE - CODE	ARTICOLI - ARTICLE
KR6801	60280-60310-60311-61280-61310-61311-68012
KR6802	60280-60310-60311-61280-61310-61311-68012-68113
KR6803	68012
KR6804	68012
KR6805	68213
KR6806	68012
KR6807	68113-68213
KR6808	68113
KR6809	68113
KR6810	68113
KR6850	60280-60310-60311-61280-61310-61311-68012
KR6851	68113
KR6852	60410-60411-61410-61411
KR7001	70365
KR7002	70365
KR7003	70365
KR7050	70365
KR7101	52010-8288.100-8290.100-8328.100-8328.1005-8330.100-8330.200-8330.300-8330.350-8330.400-8330.500-8330.800-8378.100-8378.1005-8380.100-8380.200-8380.300-8380.350-8380.400-8380.500-8390.100-8390.200-8390.300-8390.350-8390.400-8390.500-8390.800-8420.800-8430.800-8520.800-8530.800-8540.800-8550.800-89010-89011-8910-89110
KR7104	8288.100-8328.100-8328.105-8378.100-8378.105
KR7105	8288.100-8328.100-8328.105-8378.100-8378.105
KR7106	8288.100-8328.100-8328.105-8378.100-8378.105
KR7107	8330.100-8330.200-8330.300-8330.400-8330.800-8380.100-8380.200-8380.300-8380.400-8390.100-8390.200-8390.300-8390.400-8390.800
KR7108	8290.100-8292.100-8330.100-8330.300-8332.100-8332.300-8380.100-8380.300-8382.100-8382.300-8390.100-8390.300-8392.100-8392.300
KR7109	8290.100-8330.100-8330.200-8330.300-8330.350-8330.400-8330.500-8330.800-8380.100-8380.200-8380.300-8380.350-8380.400-8380.500-8390.100-8390.200-8390.300-8390.350-8390.400-8390.500-8390.800
KR7110	8290.100
KR7111	8330.350-8330.500-8380.350-8380.500-8390.350-8390.500
KR7113	8330.500-8380.500-8390.500
KR7114	8330.350-8332.350-8380.350-8382.350-8390.350-8392.350
KR7115	8330.800-8332.800-8390.800-8392.800
KR7201	8292.100-8332.100-8332.300-8332.350-8332.400-8332.500-8332.800-8382.100-8382.200-8382.300-8382.350-8382.500-8392.100-8392.200-8392.300-8392.350-8392.500-8392.800-8432.800-8532.800-8542.800
KR7203	8288.100-8290.100-8328.100-8328.105-8330.100-8330.200-8330.300-8330.350-8330.400-8330.500-8330.800-8332.100-8332.300-8332.350-8332.400-8332.500-8332.800-8378.100-8378.105-8380.100-8380.200-8380.300-8380.350-8380.400-8380.500-8382.100-8382.200-8382.300-8382.350-8382.500-8390.100-8390.200-8390.300-8390.350-8390.400-8390.500-8390.800-8392.100-8392.200-8392.300-8392.350-8392.500-8392.800
KR7207	8332.100-8332.300-8332.400-8332.800-8382.100-8382.200-8382.300-8382.500-8392.100-8392.300-8392.100-8392.200-8392.300-8392.800
KR7209	8292.100-8332.100-8332.300-8332.350-8332.400-8332.500-8332.800-8382.100-8382.200-8382.300-8382.350-8382.500-8392.100-8392.200-8392.300-8392.350-8392.500-8392.800
KR7210	8292.100
KR7211	8332.350-8332.500-8382.350-8392.350-8392.500
KR7212	8330.200-8330.400-8332.400-8380.200-8380.400-8382.200-8390.200-8390.400-8392.200
KR7213	8332.500-8382.500-8392.500
KR7301	735000-735111-735112-735131.60141-735131.60152-735131.60252-735131.60261-735141.60152-735141.60252
KR7302	735000-735111-735112-735131.60141-735131.60152-735131.60252-735131.60261-735141.60152-735141.60252
KR7303	735000-735111-735112-735131.60141-735131.60152-735131.60252-735131.60261-735141.60152-735141.60252
KR7304	735000-735111-735112-735131.60141-735131.60152-735131.60252-735131.60261-735141.60152-735141.60252
KR7305	735000-735111-735112-735131.60141-735131.60152-735131.60252-735131.60261-735141.60152-735141.60252
KR7306	735000-735111-735112-735131.60141-735131.60152-735131.60252-735131.60261-735141.60152-735141.60252
KR7307	735000-735111-735112-735131.60141-735131.60152-735131.60252-735131.60261-735141.60152-735141.60252
KR7501	7522001.100-7522001.150-7522001.200-7522001.250-7522001.300-7522001.400-7522001.450-7532001.100-7532001.150-7532001.200-7532001.250-7532001.300-7532001.400-7532001.450-7552001.100-7552001.150-7552001.200-7552001.250-7552001.300-7552001.400-7552001.450-7562001.100-7562001.150-7562001.200-7562001.250-7562001.300-7562001.400-7562001.450
KR7502	7522001.100-7522001.150-7522001.200-7522001.250-7522001.300-7522001.400-7522001.450-7532001.100-7532001.150-7532001.200-7532001.250-7532001.300-7532001.400-7532001.450-7552001.100-7552001.150-7552001.200-7552001.250-7552001.300-7552001.400-7552001.450-7562001.100-7562001.150-7562001.200-7562001.250-7562001.300-7562001.400-7562001.450



Tabella kit ricambi ed articolo o articoli di appartenenza

List of spare parts kits and item or items to which they fit

Tableau des kits de rechange de l'appareil ou des appareils auxquels ils appartiennent

Liste der ersatzteil kit und die dafür passenden geräte

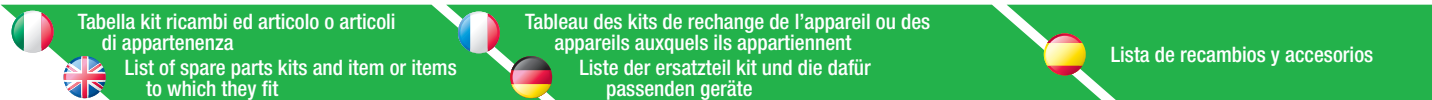
Lista de recambios y accesorios

CODICE - CODE	ARTICOLI - ARTICLE
KR7503	7522001.100-7522001.150-7522001.200-7522001.250-7522001.300-7522001.400-7522001.450-7532001.100-7532001.150-7532001.200-7532001.250-7532001.300-7532001.400-7532001.450-7552001.100-7552001.150-7552001.200-7552001.250-7552001.300-7552001.400-7552001.450-7562001.100-7562001.150-7562001.200-7562001.250-7562001.300-7562001.400-7562001.450
KR7504	7522001.100-7522001.200-7522001.400-7532001.100-7532001.200-7532001.400-7552001.100-7552001.200-7552001.400-7562001.100-7562001.200-7562001.400
KR7505	7522001.150-7522001.250-7522001.300-7522001.450-7532001.150-7532001.250-7532001.300-7532001.450-7552001.150-7552001.250-7552001.300-7552.450-7562001.150-7562001.250-7562001.300-7562001.450
KR7506	7522001.100-7522001.150-7522001.200-7522001.250-7522001.300-7522001.400-7522001.450-7532001.100-7532001.150-7532001.200-7532001.250-7532001.300-7532001.400-7532001.450-7552001.100-7552001.150-7552001.200-7552001.250-7552001.300-7552001.400-7552001.450-7562001.100-7562001.150-7562001.200-7562001.250-7562001.300-7562001.400-7562001.450
KR7507	7522001.100-7522001.150-7522001.200-7522001.250-7522001.300-7522001.400-7522001.450-7532001.100-7532001.150-7532001.200-7532001.250-7532001.300-7532001.400-7532001.450
KR7508	7522001.100-7522001.150-7522001.200-7522001.250-7522001.300-7522001.400-7522001.450-7532001.100-7532001.150-7532001.200-7532001.250-7532001.300-7532001.400-7532001.450
KR7509	7552001.100-7552001.150-7552001.200-7552001.250-7552001.300-7552001.400-7552001.450-7562001.100-7562001.150-7562001.200-7562001.250-7562001.300-7562001.400-7562001.450
KR7510	7552001.100-7552001.150-7552001.200-7552001.250-7552001.300-7552001.400-7552001.450-7562001.100-7562001.150-7562001.200-7562001.250-7562001.300-7562001.400-7562001.450
KR7701	7721001.100-7721001.400-7741001.100-7741001.400-7751001.100-7751001.400-7771001.100-7771001.400-7721301.100-7721301.400-7741301.100-7741301.400-7751301.100-7751301.400-7771301.100-7771301.400-7721601.100-7721601.400-7741601.100-7741601.400-7751601.100-7751601.400-7771601.100-7771601.400-7721801.100-7721801.400-7741801.100-7741801.400-7751801.100-7751801.400-7771801.100-7771801.400-7721901.100-7721901.400-7741901.100-7741901.400-7751901.100-7751901.400-7771901.100-7771901.400
KR7702	7721001.100-7721001.400-7741001.100-7741001.400-7751001.100-7751001.400-7771001.100-7771001.400-
KR7703	7721001.100-7721001.400-7741001.100-7741001.400-7751001.100-7751001.400-7771001.100-7771001.400-
KR7704	7721001.100-7721001.400-7741001.100-7741001.400-7751001.100-7751001.400-7771001.100-7771001.400-
KR7705	7721001.100-7721001.400-7741001.100-7741001.400-7751001.100-7751001.400-7771001.100-7771001.400-
KR7706	7721001.100-7721001.400-7741001.100-7741001.400-7751001.100-7751001.400-7771001.100-7771001.400-
KR7707	7721001.100-7721001.400-7741001.100-7741001.400-7751001.100-7751001.400-7771001.100-7771001.400-
KR7708	7721001.100-7721001.400-7741001.100-7741001.400-7751001.100-7751001.400-7771001.100-7771001.400-
KR7709	77/22775B-77/24175B-77/25575B-77/26975B
KR7710	77/12775B-77/12775
KR7711	77/14175B-77/14175
KR7712	77/15575B-77/15575
KR7713	77/16975B-77/16975
KR7714	77/32775B-77/32775
KR7715	77/34175B-77/34175
KR7716	77/35575B-77/35575
KR7717	77/66975B-77/66975
KR7718	77/22775B-77/24175B-77/25575B-77/26975B
KR7719	77/22775B-77/24175B-77/25575B-77/26975B
KR7720	77/22775-77/24175-77/25575-77/26975
KR7721	77/12775B-77/14175B-77/15575B-77/16975B
KR7722	77/12775-77/14175-77/15575-77/16975
KR7723	7721301.100-7721301.400-7741301.100-7741301.400-7751301.100-7751301.400-7771301.100-7771301.400-7721601.100-7721601.400-7741601.100-7741601.400-7751601.100-7751601.400-7771601.100-7771601.400-7721801.100-7721801.400-7741801.100-7741801.400-7751801.100-7751801.400-7771801.100-7771801.400-7721901.100-7721901.400-7741901.100-7741901.400-7751901.100-7751901.400-7771901.100-7771901.400
KR7724	7721301.100-7721301.400-7741301.100-7741301.400-7751301.100-7751301.400-7771301.100-7771301.400
KR7725	7721601.100-7721601.400-7741601.100-7741601.400-7751601.100-7751601.400-7771601.100-7771601.400
KR7726	7721801.100-7721801.400-7741801.100-7741801.400-7751801.100-7751801.400-7771801.100-7771801.400
KR7727	7721901.100-7721901.400-7741901.100-7741901.400-7751901.100-7751901.400-7771901.100-7771901.400
KR7728	7721301.100-7721301.400-7741301.100-7741301.400-7751301.100-7751301.400-7771301.100-7771301.400-7721601.100-7721601.400-7741601.100-7741601.400-7751601.100-7751601.400-7771601.100-7771601.400-7721801.100-7721801.400-7741801.100-7741801.400-7751801.100-7751801.400-7771801.100-7771801.400-7721901.100-7721901.400-7741901.100-7741901.400-7751901.100-7751901.400-7771901.100-7771901.400
KR7729	7721301.100-7721301.400-7741301.100-7741301.400-7751301.100-7751301.400-7771301.100-7771301.400-7721601.100-7721601.400-7741601.100-7741601.400-7751601.100-7751601.400-7771601.100-7771601.400-7721801.100-7721801.400-7741801.100-7741801.400-7751901.100-7751901.400-7771901.100-7771901.400
KR7730	7721801.100-7721801.400-7741801.100-7741801.400-7751801.100-7751801.400-7771801.100-7771801.400
KR8001	80035
KR8002	80035



Tabella kit ricambi ed articolo o articoli di appartenenza

List of spare parts kits and item or items to which they fit

Tableau des kits de rechange de l'appareil ou des appareils auxquels ils appartiennent

Liste der ersatzteil kit und die dafür passenden geräte

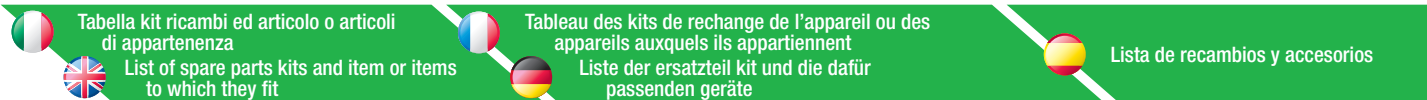
Lista de recambios y accesorios

CODICE - CODE	ARTICOLI - ARTICLE
KR8003	80050
KR8004	80050
KR8005	80200
KR8006	80200
KR8007	80201
KR8008	80201
KR8009	80040
KR8010	80210-80215
KR8011	80210-80215
KR8012	42085-43084-43085-44084-44085
KR8013	80040
KR8014	80215
KR8102	8420.100-8420.200-8420.300-8420.350-8420.400-8420.500-8430.100-8430.200-8430.300-8430.350-8430.400-8430.500-8440.100-8440.400-8440.500-8450.100-8450.400-8450.500-8520.100-8520.200-8520.300-8520.350-8520.400-8520.500-8530.100-8530.200-8530.300-8530.350-8530.400-8530.500-9430.100-9430.200-9430.300-9430.400-9430.500-9450.100-9450.400-9450.500
KR8104	8422.100-8422.500-8424.200-8424.300-8424.350-8432.100-8432.500-8434.200-8434.300-8434.350-8522.100-8522.500-8524.200-8524.300-8524.350-8532.100-8532.500-8534.200-8534.300-8534.350-9432.100-9432.500-9434.200-9434.300
KR8105	8420.100-8420.200-8420.300-8420.350-8420.400-8420.500-8420.700-8420.800-8420.1000-8430.100-8430.200-8430.300-8430.350-8430.400-8430.500-8430.700-8430.800-8430.1000-8430.3000-8430.4000-8430.5000-8436.200-8520.100-8520.200-8520.300-8520.350-8520.400-8520.500-8520.700-8520.800-8530.100-8530.200-8530.300-8530.350-8530.400-8530.500-8530.600-8530.700-8530.800-8530.1000-8530.3000-8530.4000-8530.5000-8536.200-9430.100-9430.200-9430.300-9430.400-9430.500
KR8106	8422.100-8422.500-8424.200-8424.300-8424.350-8432.100-8432.500-8434.200-8434.300-8434.350-8432.700-8432.800-8437.250-8522.100-8522.500-8524.200-8524.300-8524.350-8532.100-8532.500-8534.200-8534.300-8534.350-8532.700-8532.800-9432.100-9432.500-9434.200-9434.300
KR8107	8420.100-8420.200-8420.300-8420.350-8420.400-8420.500-8420.700-8420.800-8420.1000-8430.100-8430.200-8430.300-8430.350-8430.400-8430.500-8430.700-8430.800-8430.1000-8430.3000-8430.4000-8430.5000-9430.100-9430.200-9430.300-9430.400-9430.500
KR8201	8380.100-8380.200-8380.300-8380.350-8380.400-8380.500
KR8202	8382.100-8382.200-8382.300-8382.350-8382.500
KR8302	8440.100-8440.400-8440.500-8450.100-8450.400-8450.500-9450.100-9450.400-9450.500
KR8306	8420.100-8420.200-8420.300-8420.350-8420.400-8420.500-8420.700-8420.800-8420.1000-8422.100-8422.500-8424.200-8424.300-8424.350-8430.100-8430.200-8430.300-8430.350-8430.400-8430.500-8430.700-8430.800-8430.1000-8430.3000-8430.4000-8430.5000-8432.100-8432.500-8434.200-8434.300-8434.350-8432.700-8432.800-8436.200-8437.250-8440.100-8440.400-8440.500-8450.100-8450.400-8450.500-8520.100-8520.200-8520.300-8520.350-8520.400-8520.500-8520.700-8520.800-8522.100-8522.500-8524.200-8524.300-8524.350-8530.100-8530.200-8530.300-8530.350-8530.400-8530.500-8530.600-8530.700-8530.800-8530.1000-8530.3000-8530.4000-8530.5000-8532.100-8532.500-8534.200-8534.300-8534.350-8532.700-8532.800-8536.200-8537.200-8540.100-8540.200-8540.400-8540.105-8540.205-8540.300-8540.350-8540.405-8540.500-8540.700-8540.800-8540.5000-8542.100-8544.200-8542.105-8542.500-8544.205-8544.300-8544.350-8542.700-8542.800-8549.0100-8549.0110-8550.100-8550.200-8550.400-8550.105-8550.205-8550.300-8550.350-8550.405-8550.500-8550.700-8550.800-8552.100-8554.200-8552.105-8552.500-8554.205-8554.300-8554.350-8560.100-8560.200-8560.400-8560.106-8560.206-8560.300-8560.350-8560.406-8562.100-8564.200-8562.106-8564.206-8564.300-8564.350-9430.100-9430.200-9430.300-9430.400-9430.500-9450.100-9450.400-9450.500-9432.100-9432.500-9434.200-9434.300
KR8307	8420.100-8420.200-8420.300-8420.350-8420.400-8420.500-8420.700-8420.800-8420.1000-8422.100-8422.500-8424.200-8424.300-8424.350-8430.100-8430.200-8430.300-8430.350-8430.400-8430.500-8430.700-8430.800-8430.1000-8430.3000-8430.4000-8430.5000-8432.100-8432.500-8434.200-8434.300-8434.350-8432.700-8432.800-8436.200-8437.250-8440.100-8440.400-8440.500-8450.100-8450.400-8450.500-9430.100-9430.200-9430.300-9430.400-9430.500-9450.100-9450.400-9450.500-9432.100-9432.500-9434.200-9434.300
KR8308	8520.100-8520.200-8520.300-8520.350-8520.400-8520.500-8520.700-8520.800-8522.100-8522.500-8524.200-8524.300-8524.350-8530.100-8530.200-8530.300-8530.350-8530.400-8530.500-8530.600-8530.700-8530.800-8530.1000-8530.3000-8530.4000-8530.5000-8532.100-8532.500-8534.200-8534.300-8534.350-8532.700-8532.800-8536.200-8537.200-8540.100-8540.200-8540.400-8540.105-8540.205-8540.300-8540.350-8540.405-8540.500-8540.700-8540.800-8540.5000-8542.100-8544.200-8542.105-8542.500-8544.205-8544.300-8544.350-8542.700-8542.800-8549.0100-8549.0110-8550.100-8550.200-8550.400-8550.105-8550.205-8550.300-8550.350-8550.405-8550.500-8550.700-8550.800-8552.100-8554.200-8552.105-8552.500-8554.205-8554.300-8554.350-8560.100-8560.200-8560.400-8560.106-8560.206-8560.300-8560.350-8560.406-8562.100-8564.200-8562.106-8564.206-8564.300-8564.350
KR8408	8440.100-8440.400-8440.500-8450.100-8450.400-8450.500-9450.100-9450.400-9450.500
KR8510	8422.100-8422.500-8424.200-8424.300-8424.350-8432.100-8432.500-8434.200-8434.300-8434.350-8432.700-8432.800-9432.100-9432.500-9434.200-9434.300
KR8515	8292.100-8332.100-8332.300-8332.350-8332.400-8332.500-8332.800-8382.100-8382.200-8382.300-8382.350-8382.500-8392.100-8392.200-8392.300-8392.350-8392.500-8392.800-8522.100-8522.500-8524.200-8524.300-8524.350-8532.100-8532.500-8534.200-8534.300-8534.350-8532.700-8532.800



Tabella kit ricambi ed articolo o articoli di appartenenza

List of spare parts kits and item or items to which they fit

Tableau des kits de rechange de l'appareil ou des appareils auxquels ils appartiennent

Liste der ersatzteil kit und die dafür passenden geräte

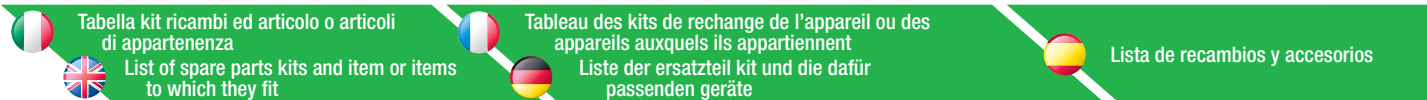
Lista de recambios y accesorios

CODICE - CODE	ARTICOLI - ARTICLE
KR8601	8617.100-8617.200-8617.400-8617.500-8617.600-8618.100-8618.200-8618.400-8618.500-8637.100-8637.200-8637.400-8637.500-8637.600-8638.100-8638.200-8638.400-8638.500
KR8602	8617.100-8617.200-8617.400-8617.500-8618.100-8618.200-8618.400-8618.500
KR8603	8618.100-8618.200-8618.400-8618.500-8638.100-8638.200-8638.400-8638.500
KR8604	8618.100-8618.200-8618.400-8618.500-8638.100-8638.200-8638.400-8638.500
KR8605	8617.600
KR8606	8637.100-8637.200-8637.400-8637.500-8638.100-8638.200-8638.400-8638.500
KR8607	8638.100-8638.200-8638.400-8638.500
KR8608	8617.100-8617.200-8617.400-8617.500-8617.600-8618.100-8618.200-8618.400-8618.500
KR8609	8617.100-8617.200-8617.400-8617.500-8617.600-8637.100-8637.200-8637.400-8637.500-8637.600
KR8610	8637.100-8637.200-8637.400-8637.500-8637.600
KR8611	8637.600
KR8612	8617.600-8637.600
KR8613	8617.100-8617.200-8617.400-8617.500-8617.600-8618.100-8618.200-8618.400-8618.500
KR8614	8637.100-8637.200-8637.400-8637.500-8637.600-8638.100-8638.200-8638.400-8638.500
KR8701	9430.100-9430.200-9430.300-9430.400-9430.500-9450.100-9450.400-9450.500
KR8702	9430.100-9430.200-9430.300-9430.400-9430.500-9450.100-9450.400-9450.500
KR8703	9432.100-9432.500-9434.200-9434.300
KR8704	9432.100-9432.500-9434.200-9434.300
KR8705	8436.200-8437.250-8530.600-8536.200-8537.200-8540.100-8540.200-8540.400-8540.105-8540.205-8540.300-8540.350-8540.405-8540.500-8542.100-8542.105-8542.500-8544.205-8544.300-8544.350-8545.200-8549.0100-8549.0110-8550.100-8550.200-8550.400-8550.105-8550.205-8550.300-8550.350-8550.400-8550.500-8552.100-8554.200-8552.105-8552.500-8554.205-8554.300-8554.350-8560.100-8560.200-8560.400-8560.106-8560.206-8560.300-8560.350-8560.406-8562.100-8564.200-8562.106-8564.206-8564.300-8564.350
KR8802	8420.100-8420.200-8420.300-8420.350-8420.400-8420.500-8420.700-8420.800-8420.1000-8440.100-8440.400-8440.500
KR8803	8422.100-8422.500-8424.200-8424.300-8424.350
KR8815	8288.100-8290.100-8328.100-8328.105-8330.100-8330.200-8330.300-8330.350-8330.400-8330.500-8330.800-8378.100-8378.105-8380.100-8380.200-8380.300-8380.350-8380.400-8380.500-8390.100-8390.200-8390.300-8390.350-8390.400-8390.500-8390.800-8520.100-8520.200-8520.300-8520.350-8520.400-8520.500-8520.700-8520.800-8530.100-8530.200-8530.300-8530.350-8530.400-8530.500-8530.700-8530.800-8530.1000-8530.3000-8530.4000-8530.5000
KR8816	8520.100-8520.200-8520.300-8520.350-8520.400-8520.500-8520.700-8520.800
KR8817	8436.200
KR8818	8437.250
KR8820	8522.100-8522.500-8524.200-8524.300-8524.350
KR8822	8550.100-8550.200-8550.400-8550.105-8550.205-8550.300-8550.350-8550.405-8550.500-8550.700-8550.800
KR8823	8552.100-8554.200-8552.105-8552.500-8554.205-8554.300-8554.350
KR8901	52010-89010-89011
KR8902	52010-89010-89011-89109-89110
KR8903	52010-89010-89011-89109-89110
KR8905	52010-89010-89011-89109-89110
KR8907	8420.700-8420.1000-8430.700-8430.1000-8430.3000-8430.4000-8430.5000-8520.700-8530.700-8530.1000-8530.3000-8530.4000-8530.5000-8540.700-8540.5000-8550.700
KR8912	89109-89110
KR8913	8432.700-8532.700-8542.700
KR8914	89010-89011-89109-89110
KR8915	52010-89010-89011-89109-89110
KR9001	90C/51-90C/71-91C/71-92C/71-93C/71-90C/111-91C/111-92C/111-91C/701-90FSP/451-90F/451-91F/451-92F/451-90F/51-90F/71-91F/71-90F/111-91F/111-90D/51-90D/71-90D/111-94D/61-95D/61-90D/21-90DV/21-115D/31-115DV/31-115D/91-115D/121-115D/181-120D/91-115F/91-115F/121-116F/121-115F/181-116F/181-115FSP/751-115F/751-116F/751-117F/751-115F/401-116F/401-117F/401-118F/401-118FSP/401
KR9003	90C/51-90C/71-91C/71-92C/71-93C/71-90C/111-91C/111-92C/111-91C/701-90FSP/451-90F/451-91F/451-92F/451-90F/51-90F/71-91F/71-90F/111-91F/111-90D/51-90D/71-90D/111-94D/61-95D/61-90D/21-90DV/21-115D/31-115DV/31-115D/91-115D/121-115D/181-120D/91-115F/91-115F/121-116F/121-115F/181-116F/181-115FSP/751-115F/751-116F/751-117F/751-115F/401-116F/401-117F/401-118F/401-118FSP/401-150F/701-151F/701-152F/701-153FSP/701-153F/701-150D/41-150D/61-150DV/61-180D/81-180D/81-180D/51
KR9005	90C/51-90C/71-91C/71-92C/71-93C/71-90C/111-91C/111-92C/111-91C/701-90FSP/451-90F/451-91F/451-92F/451-90F/51-90F/71-91F/71-90F/111-91F/111-90D/51-90D/71-90D/111-94D/61-95D/61-90D/21-90DV/21-115D/31-115DV/31-115D/91-115D/121-115D/181-120D/91-115F/91-115F/121-116F/121-115F/181-116F/181-115FSP/751-115F/751-116F/751-117F/751-115F/401-116F/401-117F/401-118F/401-118FSP/401-150F/701-151F/701-152F/701-153FSP/701-153F/701-150D/41-150D/61-150DV/61-180D/81-180D/81-180D/51
KR9006	90C/51-90C/71-91C/71-92C/71-93C/71-90C/111-91C/111-92C/111-91C/701-90FSP/451-90F/451-91F/451-92F/451-90F/51-90F/71-91F/71-90F/111-91F/111-90D/51-90D/71-90D/111-94D/61-95D/61-90D/21-90DV/21-115D/31-115DV/31-115D/91-115D/121-115D/181-120D/91-115F/91-115F/121-116F/121-115F/181-116F/181-115FSP/751-115F/751-116F/751-117F/751-115F/401-116F/401-117F/401-118F/401-118FSP/401-150F/701-151F/701-152F/701-153FSP/701-153F/701-150D/41-150D/61-150DV/61-180D/81-180D/81-180D/51



Tabella set ricambi ed articolo o articoli di appartenenza
List of spare parts kits and item or items to which they fit

Tableau des sets de rechange de l'appareil ou des appareils auxquels ils appartiennent
Liste der ersatzteil kit und die dafür passenden geräte

Lista de recambios y accesorios

CODICE - CODE	ARTICOLI - ARTICLE
KR9047	90C/111-91C/111-92C/111
KR9048	90C/111
KR9049	90C/111
KR9050	90C/51-90C/71-91C/71-92C/71-93C/71-90C/111-91C/111-92C/111-91C/701-90FSP/451-90F/451-91F/451-92F/451-90F/51-90F/71-91F/71-90F/111-90D/51-90D/71-90D/111-94D/61-95D/61-90D/21-90DV/21-115D/31-115DV/31-115D/91-115D/121-115D/181-120D/91-115F/91-115F/121-115F/181-116F/181-116F/401-116F/401-117F/401-118F/401-118FSP/401
KR9051	90C/51
KR9052	90C/51-90F/51-115F/91
KR9053	90C/71-91C/71-92C/71-93C/71
KR9054	90C/71-91C/71-92C/71-93C/71-90F/71-91F/71-115F/121-116F/121
KR9055	90C/51-90C/71-91C/71-92C/71-93C/71-90C/111-91C/111-92C/111-91C/701-90FSP/451-90F/451-91F/451-92F/451-90F/51-90F/71-91F/71-90F/111-91F/111-90D/51-90D/71-90D/111-94D/61-95D/61-90D/21-90DV/21
KR9056	115D/31-115DV/31-115D/91-115D/121-115D/181-120D/91-115F/91-115F/121-116F/121-115F/181-116F/181-115FSP/751-115F/751-116F/751-117F/751-115F/401-116F/401-117F/401-118F/401-118FSP/401
KR9057	90F/51-115F/91
KR9058	90F/71-91F/71-115F/121-116F/121
KR9059	90F/111-91F/111-115F/181-116F/181
KR9060	91C/111-92C/111-90F/111-91F/111-115F/181-116F/181
KR9061	150F/701-151F/701-152F/701-153FSP/701-153F/701-150D/41-150D/61-150DV/61-180DV/81-180D/81-180D/51
KR9062	150F/701-151F/701-152F/701-153FSP/701-153F/701-150D/41-150D/61-150DV/61
KR9063	180D/51-180D/81-180DV/81
KR9064	180D/51-180D/81-180DV/81
KR9065	115F/401-116F/401-117F/401-118F/401-118FSP/401-150F/701-151F/701-152F/701-153FSP/701-153F/701
KR9066	115F/401-116F/401-117F/401-118F/401-118FSP/401-150F/701-151F/701-152F/701-153FSP/701-153F/701
KR9067	90C/111-91C/111-92C/111
KR9068	90C/111
KR9071	150F/701-151F/701-152F/701-153FSP/701-153F/701-150D/41-150D/61-150DV/61-180DV/81-180D/81-180D/51
KR9101	91C/701
KR9102	91C/701-90FSP/451-90F/451-91F/451-92F/451-115FSP/751-115F/751-116F/751-117F/751
KR9103	91C/701
KR9104	91C/701
KR9105	91C/701
KR9106	91C/701-90FSP/451-90F/451-91F/451-92F/451-90D/51-90D/71-90D/111-94D/61-95D/61-90D/21-90DV/21
KR9107	91C/701-90FSP/451-90F/451-91F/451-92F/451-90D/51-90D/71-90D/111-94D/61-95D/61-90D/21-90DV/21
KR9108	90FSP/451-90F/451-91F/451-92F/451-115FSP/751-115F/751-116F/751-117F/751
KR9109	115D/31-115DV/31-115D/91-115D/121-115D/181-120D/91-115FSP/751-115F/751-116F/751-117F/751-115F/401-116F/401-117F/401-118F/401-118FSP/401
KR9110	115D/31-115DV/31-115D/91-115D/121-115D/181-120D/91-115FSP/751-115F/751-116F/751-117F/751-115F/401-116F/401-117F/401-118F/401-118FSP/401
KR9111	90FSP/451-90F/451-91F/451-92F/451-115FSP/751-115F/751-116F/751-117F/751
KR9112	90FSP/451-90F/451-91F/451-92F/451-115FSP/751-115F/751-116F/751-117F/751
KR9113	90FSP/451-90F/451-91F/451-92F/451-115FSP/751-115F/751-116F/751-117F/751
KR9114	90D/51-90D/71-90D/111-94D/61-95D/61-115D/91-115D/121-115D/181-120D/91
KR9115	90D/51-90D/71-90D/111-115D/91-115D/121-115D/181
KR9116	90D/111-115D/181
KR9117	90D/111-115D/181
KR9118	90D/111-115D/181
KR9119	90D/71-115D/121
KR9120	90D/71-115D/121
KR9121	90D/71-115D/121
KR9122	90D/51-115D/91
KR9123	90D/51-115D/91
KR9124	90D/51-115D/91
KR9125	90D/21-90DV/21-115D/31-115DV/31
KR9126	90D/21-90DV/21-115D/31-115DV/31-150D/41-150D/61-150DV/61-180DV/81-180D/81-180D/51
KR9127	90D/21-115D/31-150D/61-180D/81
KR9128	90D/21-115D/31-150D/61-180D/81
KR9129	90D/21-115D/31-150D/61-180D/81
KR9130	90D/21-90DV/21-115D/31-115DV/31-150D/41-150D/61-150DV/61-180DV/81-180D/81-180D/51

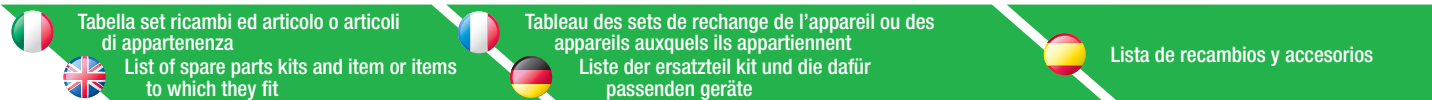

Tabella kit ricambi ed articolo o articoli di appartenenza

Tableau des kits de rechange de l'appareil ou des appareils auxquels ils appartiennent

List of spare parts kits and item or items to which they fit

Liste der ersatzteil kit und die dafür passenden geräte

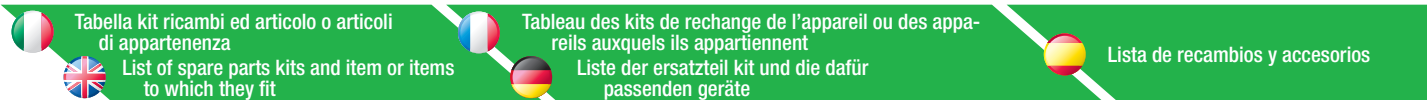
Lista de recambios y accesorios

CODICE - CODE	ARTICOLI - ARTICLE
KR9131	150F/701-151F/701-152F/701-153FSP/701-153F/701-150D/41-150D/61-150DV/61
KR9132	150F/701-151F/701-152F/701-153FSP/701-153F/701-150D/41-150D/61-150DV/61
KR9133	150D/41-150D/61-150DV/61-180DV/81-180D/81-180D/51
KR9134	150D/41-180D/51
KR9135	150D/41-180D/51
KR9136	150D/41-180D/51
KR9137	180DV/81-180D/81-180D/51
KR9138	180DV/81-180D/81-180D/51
KR9139	90DV/21-115DV/31-150DV/61-180DV/81
KR9140	90DV/21-115DV/31-150DV/61-180DV/81
KR9141	90DV/21-115DV/31-150DV/61-180DV/81
KR9150	91C/701
KR9151	91C/701
KR9152	90FSP/451-90F/451-91F/451-92F/451-115FSP/751-115F/751-116F/751-117F/751
KR9153	90FSP/451-90F/451-91F/451-92F/451-115FSP/751-115F/751-116F/751-117F/751
KR9154	90D/111-115D/181
KR9155	90D/111-115D/181
KR9156	90D/71-115D/121
KR9157	90D/71-115D/121
KR9158	90D/51-115D/91
KR9159	90D/51-115D/91
KR9160	90D/21-115D/31-150D/61-180D/81
KR9161	90D/21-115D/31-150D/61-180D/81
KR9162	150D/41-180D/51
KR9163	150D/41-180D/51
KR9164	90DV/21-115DV/31-150DV/61-180DV/81
KR9165	90DV/21-115DV/31-150DV/61-180DV/81
KR9201	94D/61-95D/61-120D/91
KR9202	95D/61-120D/91
KR9203	94D/61-95D/61-120D/91
KR9204	95D/61-120D/91
KR9210	8540.100-8540.200-8540.400-8540.105-8540.205-8540.300-8540.350-8540.405-8540.500-8540.700-8540.800-8540.5000-8549.0100-8549.0110-8550.100-8550.200-8550.400-8550.105-8550.205-8550.300-8550.350-8550.405-8550.500-8550.700-8550.800-8560.100-8560.200-8560.400-8560.106-8560.206-8560.300-8560.350-8560.406
KR9211	94D/61
KR9212	94D/61
KR9215	8537.200-8542.100-8544.200-8542.105-8542.500-8544.205-8544.300-8544.350-8542.700-8542.800-8545.200-8552.100-8554.200-8552.105-8552.500-8554.205-8554.300-8554.350-8562.100-8564.200-8562.106-8564.206-8564.300-8564.350
KR9218	8537.200
KR9219	8530.600-8536.200
KR9220	8560.100-8560.200-8560.400-8560.106-8560.206-8560.300-8560.350-8560.406
KR9225	8562.100-8564.200-8562.106-8564.206-8564.300-8564.350
KR9230	8540.100-8540.200-8540.400-8540.105-8540.205-8540.300-8540.350-8540.405-8540.500-8540.700-8540.800-8540.5000-8549.0100-8549.0110-8550.100-8550.200-8550.400-8550.105-8550.205-8550.300-8550.350-8550.405-8550.500-8550.700-8550.800
KR9235	8542.100-8544.200-8542.105-8542.500-8544.205-8544.300-8544.350-8542.700-8542.800-8552.100-8554.200-8552.105-8552.500-8554.205-8554.300-8554.350
KR9236	8545.200
KR9250	94D/61-95D/61-120D/91
KR9251	94D/61-95D/61-120D/91
KR9252	94D/61



Tabella set ricambi ed articolo o articoli di appartenenza
List of spare parts kits and item or items to which they fit



Tableau des sets de rechange de l'appareil ou des appareils auxquels ils appartiennent
Liste der ersatzteil kit und die dafür passenden geräte



Lista de recambios y accesorios

CODICE - CODE	ARTICOLI - ARTICLE
KS1080	10705-10805-10807
KS1081	10105-10205-10207
KS2280	22017-22017/N-22024/N-23024-23024/N-23025-23025/N
KS3280	30050-30051-30200
KS3281	32024-32065-32067-32068
KS3282	31200
KS3283	31201
KS3380	33016-33024
KS3381	33060-33060/A-33061-33094-33096
KS3382	33160-33161-33194-33196
KS3383	33070-33070/A-33071-33072-33073-33125
KS3384	33080-33081-33082-33083
KS3385	33170-33171-33172-33173
KS3386	35060-35061-35063-35076-35094
KS3387	26090-26091-26093-26094-33124
KS3388	33360-33396
KS33/82	33500-33505
KS33/105	33/2011TTPT2
KS33/107	33/2011EDDF2
KS33/110	33/2611NHHV2-3C3/2611NHH2
KS33/111	33/2611EDDF2-3C3/2611EAA2
KS33/112	33/2611TTPT2-3C3/2611TTP2
KS33/113	33/2611SDDF2-3C3/2611SSS2
KS33/114	33/2611HHHV2-3C3/2611HHH2
KS33/130	33/3011NHHV2-33/3011HHHV2-33/3011TTPT2-33/3011EDDF2-33/3011SDDF2
KS33/131	33/3011NHHV2-33/3011HHHV2-33/3011TTPT2-33/3011EDDF2-33/3011SDDF2
KS33/132	33/3011NHHV2-33/3011HHHV2-33/3011TTPT2-33/3011EDDF2-33/3011SDDF2
KS33/133	33/3011NHHV2-33/3011HHHV2-33/3011TTPT2-33/3011EDDF2-33/3011SDDF2
KS33/134	33/3011NHHV2-33/3011HHHV2-33/3011TTPT2-33/3011EDDF2-33/3011SDDF2
KS33/135	33/2011NHHV2
KS33/136	33/2011HHHV2
KS33/137	33/2011TTPT2
KS33/138	33/2011EDDF2
KS33/139	33/2011SDDF2
KS33/140	2B3/16117NH22-2B8/16117NH22
KS33/141	2B3/16117TT22-2B8/16117TT22
KS33/142	2B3/16117HH22-2B8/16117HH22
KS33/143	2B3/16117EA12-2B8/16117EA12
KS33/144	2B3/16117SS22-2B8/16117SS22
KS3580	35160-35161-35163-35173-35176-35194-35196
KS3581	35179-35180
KS3680	36060-36061-36063-36073-36076-36094-36096
KS3781	37703
KS3782	37728-37729-37730-38023-38024-38025-33120
KS3783	37740-37741-37742-37743-37758-37759-37760-37762-37764-37786-37787-37788-38020-38021-38022-33121
KS3785	33146-33147-33148-33150-33151-33152-33153
KS3786	33140-37750-37751-37752-37794-37795-37796
KS3788	37775-37776-37777-37778-37797-37798-37799
KS4280	42065-42090-42115-42160
KS4282	42091-42116
KS4284	42092
KS4380	43016-43024-43116
KS4381	43060-43090-43114
KS4382	43065-43091-43115
KS4383	43190
KS4384	43724
KS4385	43760-43790

PDF Fill PDF Editor With Free Writer and Tools



Tabella set ricambi ed articolo o articoli di appartenenza



Tableau des sets de rechange de l'appareil ou des appareils auxquels ils appartiennent
Liste der ersatzteil kit und die dafür passenden geräte



CODICE - CODE	ARTICOLI - ARTICLE
KS4386	43765
KS4480	44060
KS4481	44065
KS4482	44090
KS4483	44091-44116
KS4485	44115
KS4487	44092-44093-44117-44118
KS4488	44066-44067
KS4580	45100-45150-45180
KS4581	45110-45111
KS4582	45250-45280
KS4583	45300
KS4584	45310-45311
KS4585	45200
KS4680	46064
KS4681	42164-46065
KS4682	46114
KS4683	42215-46115-46215
KS4684	46116
KS5280	52010
KS5281	52015-53016-52024-53024
KS6280	62041-62041/A-62048-62074-62095
KS6380	63041-63048-63074-63095
KS6683	66860-66888-66889
KS6685	66880-66881-66882
KS6686	66855
KS6880	60280-60310-60311-61280-61310-61311-68000
KS6881	68213
KS6882	68113
KS7080	70365
KS9080	90C/51
KS9081	90C/71-91C/71-92C/71-93C/71
KS9082	90F/51
KS9083	115F/91
KS9084	90F/71-91F/71
KS9085	115F/121-116F/121
KS9086	90F/111-91F/111
KS9087	115F/181-116F/181
KS9088	150F/701-151F/701-152F/701-153FSP/701-153F/701
KS9089	90D/21
KS9090	90DV/21
KS9091	115D/31
KS9092	115DV/31
KS9093	150DV/61
KS9094	180DV/81
KS9180	91C/701
KS9181	90FSP/451-90F/451-91F/451-92F/451
KS9182	115FSP/751-115F/751-116F/751-117F/751
KS9183	115D/181
KS9184	115D/121
KS9185	115D/91
KS9186	90D/111
KS9187	90D/71
KS9188	90D/51
KS9189	115F/401-116F/401-117F/401-118F/401-118FSP/401
KS9190	150D/41
KS9191	150D/61

PDFfill PDF Editor with Free Writer and Tools



Tabella set ricambi ed articolo o articoli di appartenenza



List of spare parts kits and item or items to which they fit



Tableau des sets de rechange de l'appareil ou des appareils auxquels ils appartiennent



Liste der ersatzteil kit und die dafür passenden geräte



Lista de recambios y accesorios

CODICE - CODE	ARTICOLI - ARTICLE
KS9192	180D/51
KS9193	180D/81
KS9194	90C/111-91C/111- 92C/111
KS9280	95D/61
KS9281	120D/91
KS9283	94D/61

PDFill PDF Editor with Free Writer and Tools



Art. 10/80

VISTA ESPLOSA - EXPLODED VIEW

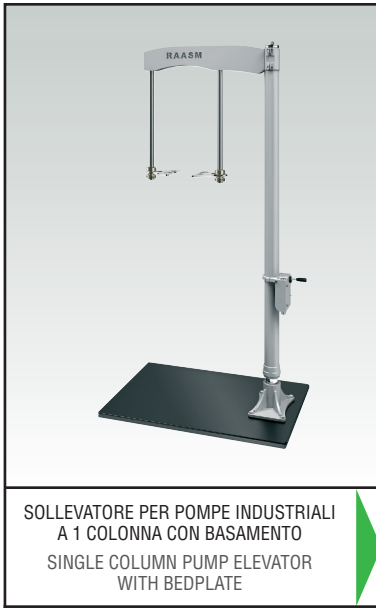

SOLLEVATORE PER POMPE INDUSTRIALI
A 1 COLONNA CON BASAMENTO
SINGLE COLUMN PUMP ELEVATOR
WITH BEDPLATE

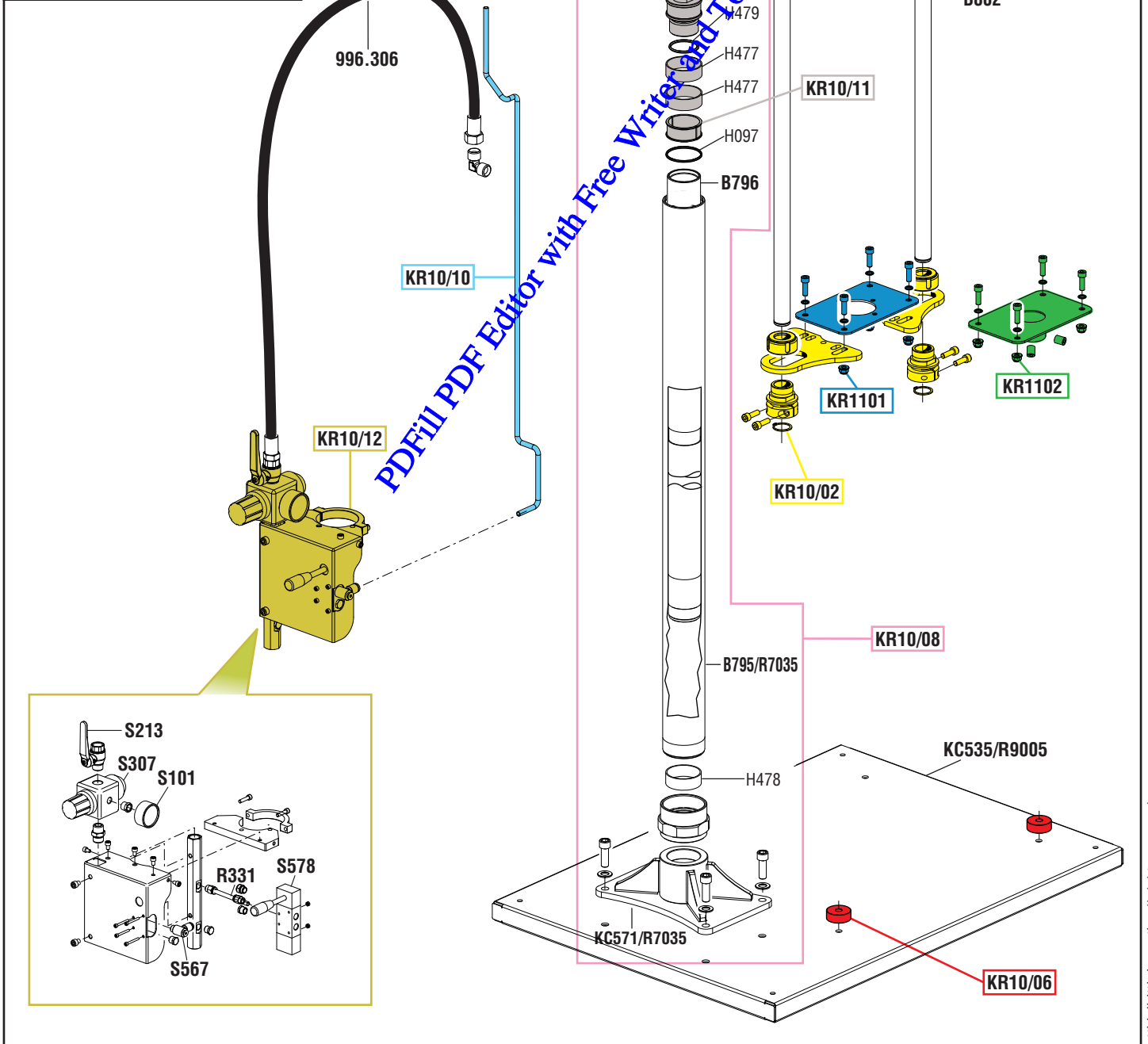

PDFFill PDF Editor with Free Writer and Tools

tutti i diritti riservati - all rights reserved



GUIDA RICAMBI - SPARE PARTS GUIDE

KIT RICAMBI		
OGNI KIT SOTTO RIPORTATO COMPRENDE I RICAMBI EVIDENZIATI CON LO STESSO COLORE E LE RELATIVE GUARNIZIONI. QUESTI RICAMBI NON SONO FORNIBILI SEPARATAMENTE TRANNE QUELLI CODIFICATI.		
SPARE PARTS KITS		
EACH KIT SHOWN WITH THE SAME COLOR INCLUDES ALSO THE GASKETS. THE SPARE PARTS INCLUDED IN THE KIT CAN'T BE SUPPLIED SEPARATELY EXCEPT THOSE SHOWN WITH A PROPER CODE.		
CODICE CODE	DESCRIZIONE DESCRIPTION	Q.TÀ QTY
KR10/02	STAFFA SUPPORTO POMPA PUMP SUPPORT BRACKET	1
KR10/06	RIFERIMENTI CENTRAGGIO FUSTO REFERENCE POINT FOR DRUM CENTERING	1
KR10/08	COLONNA PISTONE PISTON COLUMN	1
KR10/10	TUBI ALIMENTAZIONE ARIA FEEDING AIR HOSE	1
KR10/11	GUARNIZIONI SUPERIORI COLONNA COLUMN SUPERIOR GASKETS	1
KR10/12	QUADRO COMANDI SOLLEVATORE HOISTER CONTROL BOARD	1
KR10/13	SUPPORTO SOLLEVATORE HOISTER SUPPORT	1
KR1101	STAFFA SUPPORTO POMPA INTEGRALE SUPPORT BRACKET INTEGRAL PUMP	1
KR1102	STAFFA SUPPORTO POMPA PESCANTE \varnothing 30 mm SUPPORT BRACKET FOR PUMP WITH SUCTION TUBE \varnothing 30 mm	1

ELENCO RICAMBI FORNIBILI SINGOLARMENTE		
LIST OF SPARE PARTS WHICH CAN BE SUPPLIED SEPARATELY		
CODICE CODE	DESCRIZIONE DESCRIPTION	Q.TÀ QTY
996.306	TUBO 1/2" - 0,6 m - 150 bar HOSE 1/2" - 0,6 m - 150 bar	1
B802	STELO SUPPORTO POMPA SUPPORT ROD FOR PUMP	2
B795/R7035	TUBO CILINDRO CYLINDER TUBE	1
B796	STELO PISTONE PISTON ROD	1
H097	O-RING 3193 O-RING 3193	1
H477	ANELLO GUIDA GASKET	2
H478	ANELLO GUIDA GASKET	1
H479	O-RING 147 O-RING 147	1
H480	O-RING 159 O-RING 159	1
KC105	PISTONE PISTON	1
KC535/R9005	BASE SOLLEVATORE HOISTER BASE	1
KC571/R7035	BASE CILINDRO CYLINDER BASE	1
M353	DADO A TORNILLO OCCANTE M22 SELF-LOCKING NUT M22	2
M442	ROMBELLA WASHER	2
R331	TUBO ARIA AIR HOSE	1
S101	MANOMETRO \varnothing 50 mm GAUGE \varnothing 50 mm	1
S213	RUBINETTO A SFERA 1/2" BALL VALVE 1/2"	1
S307	REGOLATORE DI PRESSIONE 1/2" PRESSURE REGULATOR 1/2"	1
S567	REGOLATORE DI FLUSSO FLOW REGULATOR	1
S578	VALVOLA COMANDO CONTROL VALVE	1

PDFfill PDF Editor with Free Writer and Tools



Art. 10/81



VISTA ESPLOSA - EXPLODED VIEW

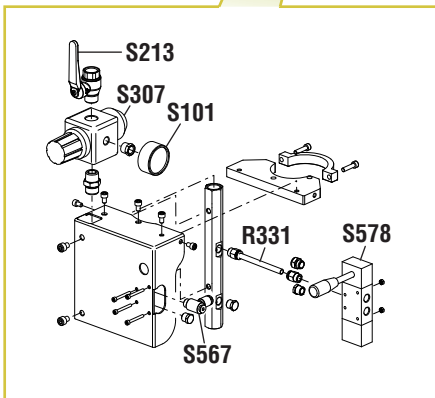
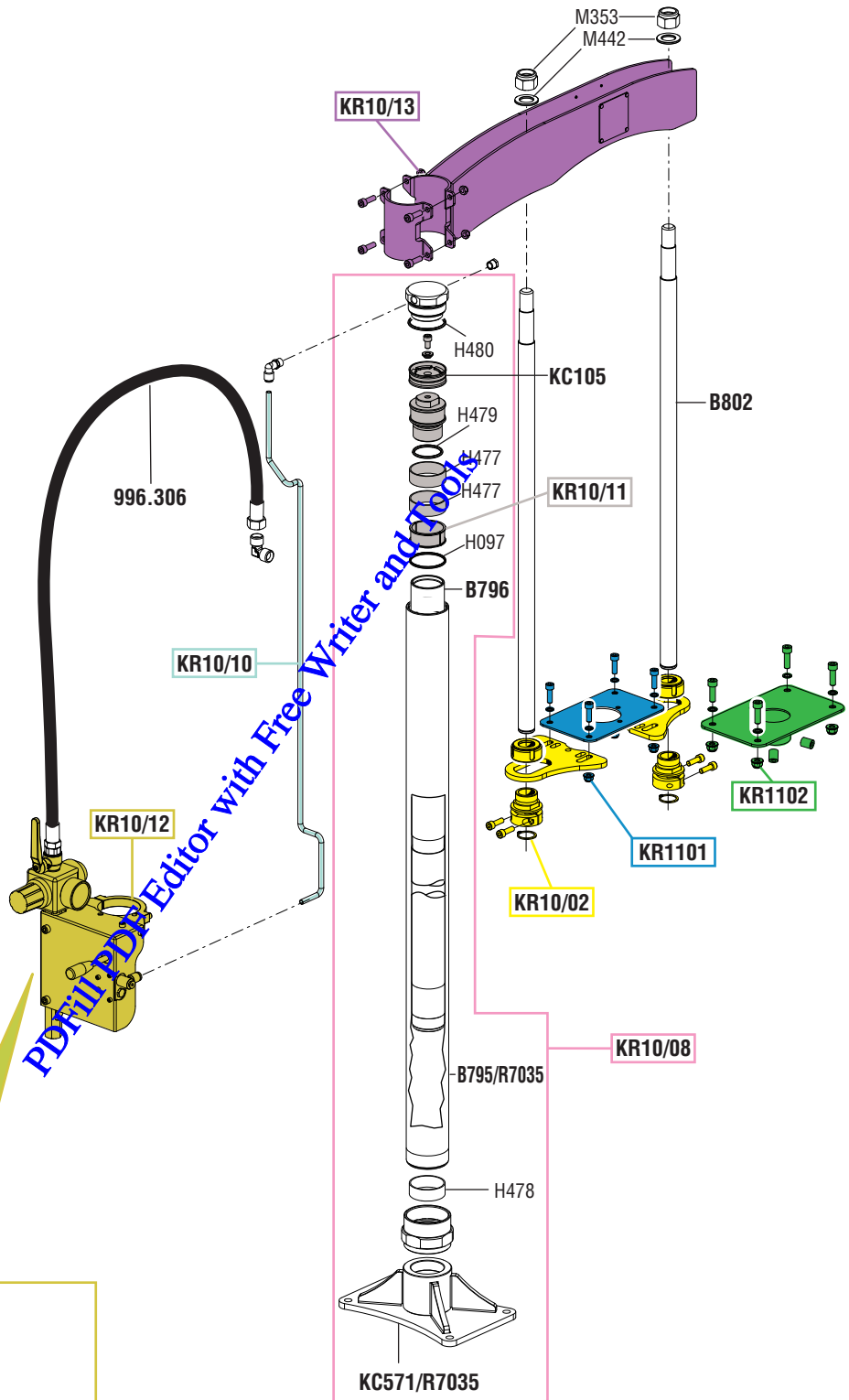

PDF File Editor with Free Writer and Tools



GUIDA RICAMBI - SPARE PARTS GUIDE

KIT RICAMBI		
OGNI KIT SOTTO RIPORTATO COMPRENDE I RICAMBI EVIDENZIATI CON LO STESSO COLORE E LE RELATIVE GUARNIZIONI. QUESTI RICAMBI NON SONO FORNIBILI SEPARATAMENTE TRANNE QUELLI CODIFICATI.		
SPARE PARTS KITS		
EACH KIT SHOWN WITH THE SAME COLOR INCLUDES ALSO THE GASKETS. THE SPARE PARTS INCLUDED IN THE KIT CAN'T BE SUPPLIED SEPARATELY EXCEPT THOSE SHOWN WITH A PROPER CODE.		
CODICE CODE	DESCRIZIONE DESCRIPTION	Q.TÀ QTY
KR10/02	STAFFA SUPPORTO POMPA PUMP SUPPORT BRACKET	1
KR10/08	COLONNA PISTONE PISTON COLUMN	1
KR10/10	TUBI ALIMENTAZIONE ARIA FEEDING AIR HOSE	1
KR10/11	GUARNIZIONI SUPERIORI COLONNA COLUMN SUPERIOR GASKETS	1
KR10/12	QUADRO COMANDI SOLLEVATORE HOISTER CONTROL BOARD	1
KR10/13	SUPPORTO SOLLEVATORE HOISTER SUPPORT	1
KR1101	STAFFA SUPPORTO POMPA INTEGRALE SUPPORT BRACKET INTEGRAL PUMP	1
KR1102	STAFFA SUPPORTO POMPA PESCANTE ø 30 mm SUPPORT BRACKET FOR PUMP WITH SUCTION TUBE ø 30 mm	1

ELENCO RICAMBI FORNIBILI SINGOLARMENTE		
LIST OF SPARE PARTS WHICH CAN BE SUPPLIED SEPARATELY		
CODICE CODE	DESCRIZIONE DESCRIPTION	Q.TÀ QTY
996.306	TUBO 1/2" - 0,6 m -150 bar HOSE 1/2" - 0,6 m -150 bar	1
B802	STELO SUPPORTO POMPA SUPPORT ROD FOR PUMP	2
B795/R7035	TUBO CILINDRO CYLINDER TUBE	1
B796	STELO PISTONE PISTON ROD	1
H097	O-RING 3193 O-RING 3193	1
H477	ANELLO GUIDA GASKET	2
H478	ANELLO GUIDA GASKET	1
H479	O-RING 147 O-RING 147	1
H480	O-RING 159 O-RING 159	1
KC105	PISTONE PISTON	1
KC571/R7035	BASE CILINDRO CYLINDER BASE	1
M353	DADO AUTOBLOCCANTE M22 SELFLOCKING NUT M22	2
M442	RONDELLA WASHER	2
R331	TUBO ARIA AIR HOSE	1
S101	MANOMETRO ø 50 mm GAUGE ø 50 mm	1
S213	RUBINETTO A SFERA 1/2" BALL VALVE 1/2"	1
S307	REGOLATORE DI PRESSIONE 1/2" PRESSURE REGULATOR 1/2"	1
S567	REGOLATORE DI FLUSSO FLOW REGULATOR	1
S578	VALVOLA COMANDO CONTROL VALVE	1

PDFfill PDF Editor with Free Writer and Tools



Art. 10/82

VISTA ESPLOSA - EXPLODED VIEW

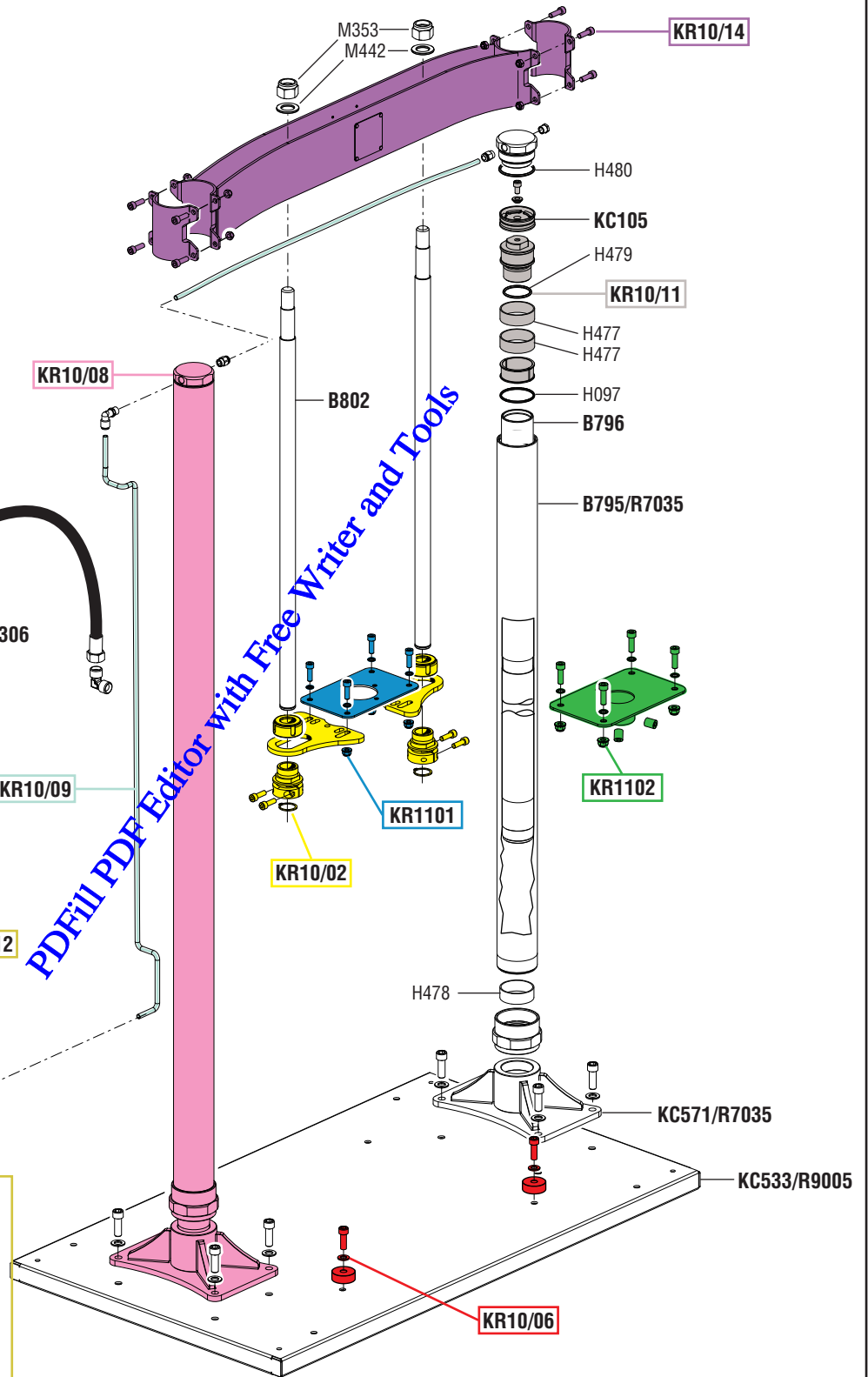

PDFill PDF Editor with Free Writer and Tools

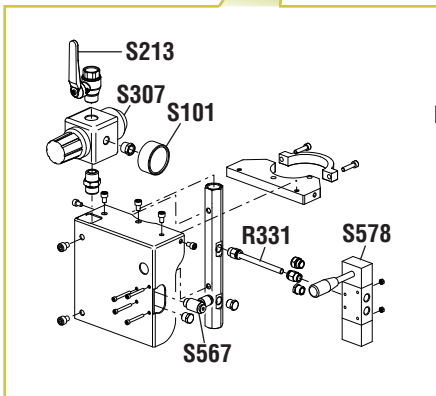

tutti i diritti riservati - all rights reserved



GUIDA RICAMBI - SPARE PARTS GUIDE

KIT RICAMBI		
OGNI KIT SOTTO RIPORTATO COMPRENDE I RICAMBI EVIDENZIATI CON LO STESSO COLORE E LE RELATIVE GUARNIZIONI. QUESTI RICAMBI NON SONO FORNIBILI SEPARATAMENTE TRANNE QUELLI CODIFICATI.		
SPARE PARTS KITS		
EACH KIT SHOWN WITH THE SAME COLOR INCLUDES ALSO THE GASKETS. THE SPARE PARTS INCLUDED IN THE KIT CAN'T BE SUPPLIED SEPARATELY EXCEPT THOSE SHOWN WITH A PROPER CODE.		
CODICE CODE	DESCRIZIONE DESCRIPTION	Q.TÀ QTY
KR10/02	STAFFA SUPPORTO POMPA PUMP SUPPORT BRACKET	1
KR10/06	RIFERIMENTI CENTRAGGIO FUSTO REFERENCE POINT FOR DRUM CENTERING	1
KR10/08	COLONNA PISTONE PISTON COLUMN	2
KR10/09	TUBI ALIMENTAZIONE ARIA FEEDING AIR HOSE	1
KR10/11	GUARNIZIONI SUPERIORI COLONNA COLUMN SUPERIOR GASKETS	2
KR10/12	QUADRO COMANDI SOLLEVATORE HOISTER CONTROL BOARD	1
KR10/14	SUPPORTO SOLLEVATORE HOISTER SUPPORT	1
KR1101	STAFFA SUPPORTO POMPA INTEGRALE SUPPORT BRACKET INTEGRAL PUMP	1
KR1102	STAFFA SUPPORTO POMPA PESCANTE \varnothing 30 mm SUPPORT BRACKET FOR PUMP WITH SUCTION TUBE \varnothing 30 mm	1

ELENCO RICAMBI FORNIBILI SINGOLARMENTE		
LIST OF SPARE PARTS WHICH CAN BE SUPPLIED SEPARATELY		
CODICE CODE	DESCRIZIONE DESCRIPTION	Q.TÀ QTY
996.306	TUBO 1/2" - 0,6 m -150 bar HOSE 1/2" - 0,6 m -150 bar	1
B802	STELO SUPPORTO POMPA SUPPORT ROD FOR PUMP	2
B795/R7035	TUBO CILINDRO CYLINDER TUBE	2
B796	STELO PISTONE PISTON ROD	2
H097	O-RING 3193 O-RING 3193	2
H477	ANELLO GUIDA GASKET	4
H478	ANELLO GUIDA GASKET	2
H479	O-RING 147 O-RING 147	2
H480	O-RING 159 O-RING 159	2
KC105	PISTONE PISTON	2
KC533/R9005	BASE SOLLEVATORE HOISTER BASE	1
KC571/R7035	BASE CILINDRO CYLINDER BASE	2
M353	DADO A SFEROCACCANTE M22 SELF-LOCKING NUT M22	2
M442	ROMBELLA WASHER	2
R331	TUBO ARIA AIR HOSE	1
S101	MANOMETRO \varnothing 50 mm GAUGE \varnothing 50 mm	1
S213	RUBINETTO A SFERA 1/2" BALL VALVE 1/2"	1
S307	REGOLATORE DI PRESSIONE 1/2" PRESSURE REGULATOR 1/2"	1
S567	REGOLATORE DI FLUSSO FLOW REGULATOR	1
S578	VALVOLA COMANDO CONTROL VALVE	1

PDFfill PDF Editor with Free Writer and Tools



Art. 10/85



VISTA ESPLOSA - EXPLODED VIEW

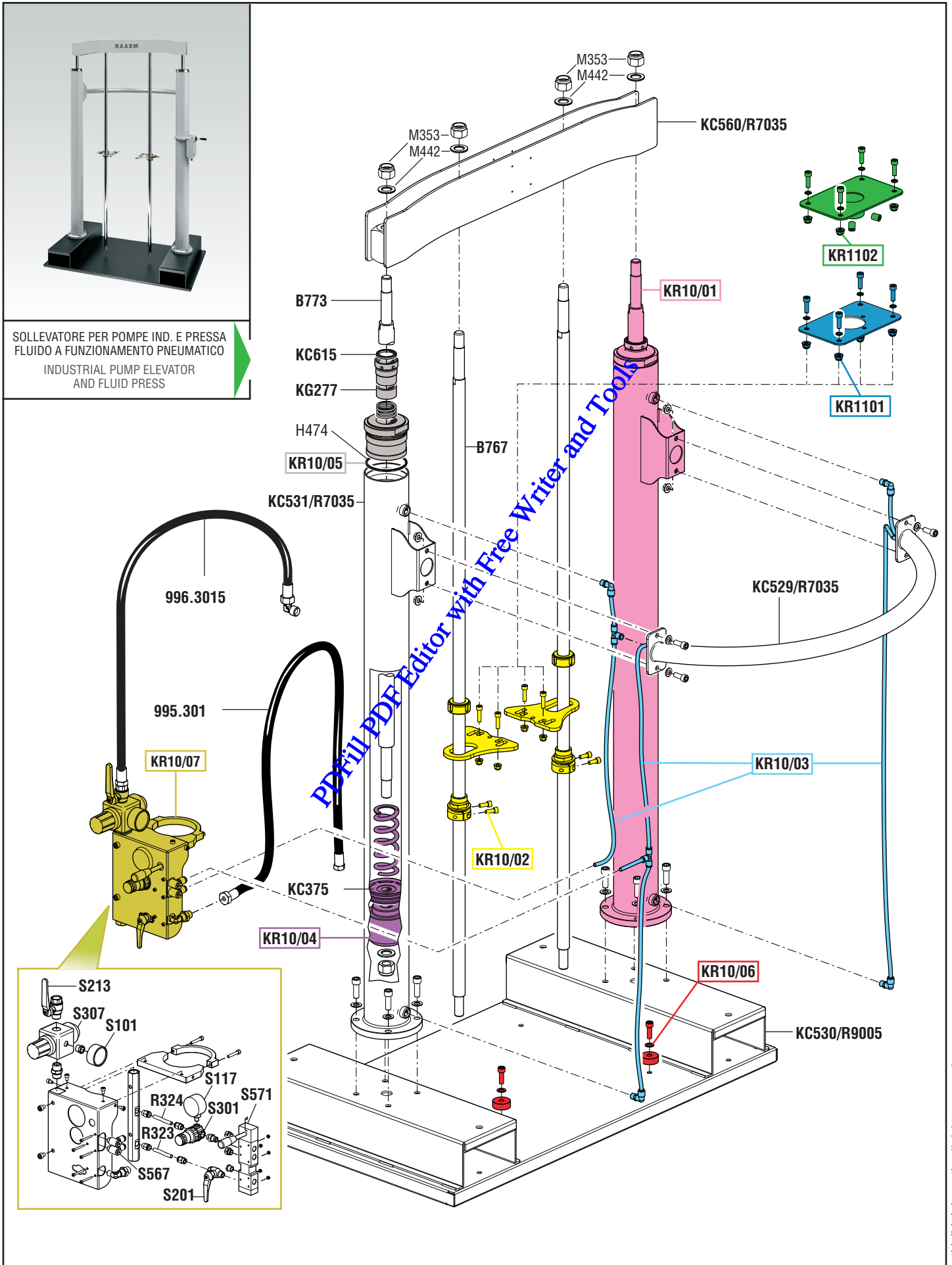

SOLLEVATORE PER POMPE IND. E PRESSA FLUIDO A FUNZIONAMENTO PNEUMATICO
 INDUSTRIAL PUMP ELEVATOR AND FLUID PRESS

tutti i diritti riservati - all rights reserved



GUIDA RICAMBI - SPARE PARTS GUIDE

KIT RICAMBI		
OGNI KIT SOTTO RIPORTATO COMPRENDE I RICAMBI EVIDENZIATI CON LO STESSO COLORE E LE RELATIVE GUARNIZIONI. QUESTI RICAMBI NON SONO FORNIBILI SEPARATAMENTE TRANNE QUELLI CODIFICATI.		
SPARE PARTS KITS		
EACH KIT SHOWN WITH THE SAME COLOR INCLUDES ALSO THE GASKETS. THE SPARE PARTS INCLUDED IN THE KIT CAN'T BE SUPPLIED SEPARATELY EXCEPT THOSE SHOWN WITH A PROPER CODE.		
CODICE CODE	DESCRIZIONE DESCRIPTION	Q.TÀ QTY
KR10/01	COLONNA PISTONE DOPPIO EFFETTO PISTON COLUMN DOUBLE EFFECT	2
KR10/02	STAFFA SUPPORTO POMPA PUMP SUPPORT BRACKET	1
KR10/03	TUBI ALIMENTAZIONE ARIA FEEDING AIR HOSE	1
KR10/04	GUARNIZIONI PISTONE COLONNA PISTON COLUMN GASKETS	2
KR10/05	GUARNIZIONI SUPERIORI COLONNA COLUMN SUPERIOR GASKETS	2
KR10/06	RIFERIMENTI CENTRAGGIO FUSTO REFERENCE POINT FOR DRUM CENTERING	1
KR10/07	QUADRO COMANDI SOLLEVATORE HOISTER CONTROL BOARD	1
KR1101	STAFFA SUPPORTO POMPA INTEGRALE SUPPORT BRACKET INTEGRAL PUMP	1
KR1102	STAFFA SUPPORTO POMPA PESCANTE ø 30 mm SUPPORT BRACKET FOR PUMP WITH SUCTION TUBE ø 30 mm	1

ELENCO RICAMBI FORNIBILI SINGOLARMENTE		
LIST OF SPARE PARTS WHICH CAN BE SUPPLIED SEPARATELY		
CODICE CODE	DESCRIZIONE DESCRIPTION	Q.TÀ QTY
995.301	TUBO 3/8" - 1,2 m - 150 bar HOSE 3/8" - 1,2 m - 150 bar	1
996.3015	TUBO 1/2" - 1,5 m - 150 bar HOSE 1/2" - 1,5 m - 150 bar	1
B767	STELO SUPPORTO POMPA PUMP ROD FOR PUMP	2
B773	STELO PISTONE PISTON ROD	2
H474	O-RING 4337 O-RING 4337	2
KC375	PISTONE MOTORE MOTOR PISTON	2
KC529/R7035	TUBO COLLEGAMENTO CONNECTION HOSE	1
KC530/R9005	BASE SOLLEVATORE HOISTER BASE	1
KC531/R7035	TUBO CILINDRO CYLINDER TUBE	2
KC560/R7035	SUPPORTO SOLLEVATORE HOISTER BASE	1
KC615	RASCHIATORE STELO ROD SCRAPER	2
KG277	PACCO GUARNIZIONI GASKETS KIT	2
M353	DADO AUTOLUBRIFICANTE M22 SELF-LUBRICATING NUT M22	4
M442	ROMBELLA WASHER	4
R323	TUBETTO ARIA AIR HOSE	1
R324	TUBETTO ARIA AIR HOSE	1
S107	MANOMETRO ø 50 mm GAUGE ø 50 mm	1
S117	MANOMETRO ø 50 mm GAUGE ø 50 mm	1
S201	RUBINETTO A SFERA 1/4" BALL VALVE 1/4"	1
S213	RUBINETTO A SFERA 1/2" BALL VALVE 1/2"	1
S301	REGOLATORE DI PRESSIONE 1/4" PRESSURE REGULATOR 1/4"	1
S307	REGOLATORE DI PRESSIONE 1/2" PRESSURE REGULATOR 1/2"	1
S567	REGOLATORE DI FLUSSO FLOW REGULATOR	2
S571	VALVOLA COMANDO CONTROL VALVE	1

PDFfill PDF Editor with Free Writer and Tools



Art. 10105 - Art. 10205 - Art. 10207 Mod. S.F.2C

VISTA ESPLOSA - EXPLODED VIEW

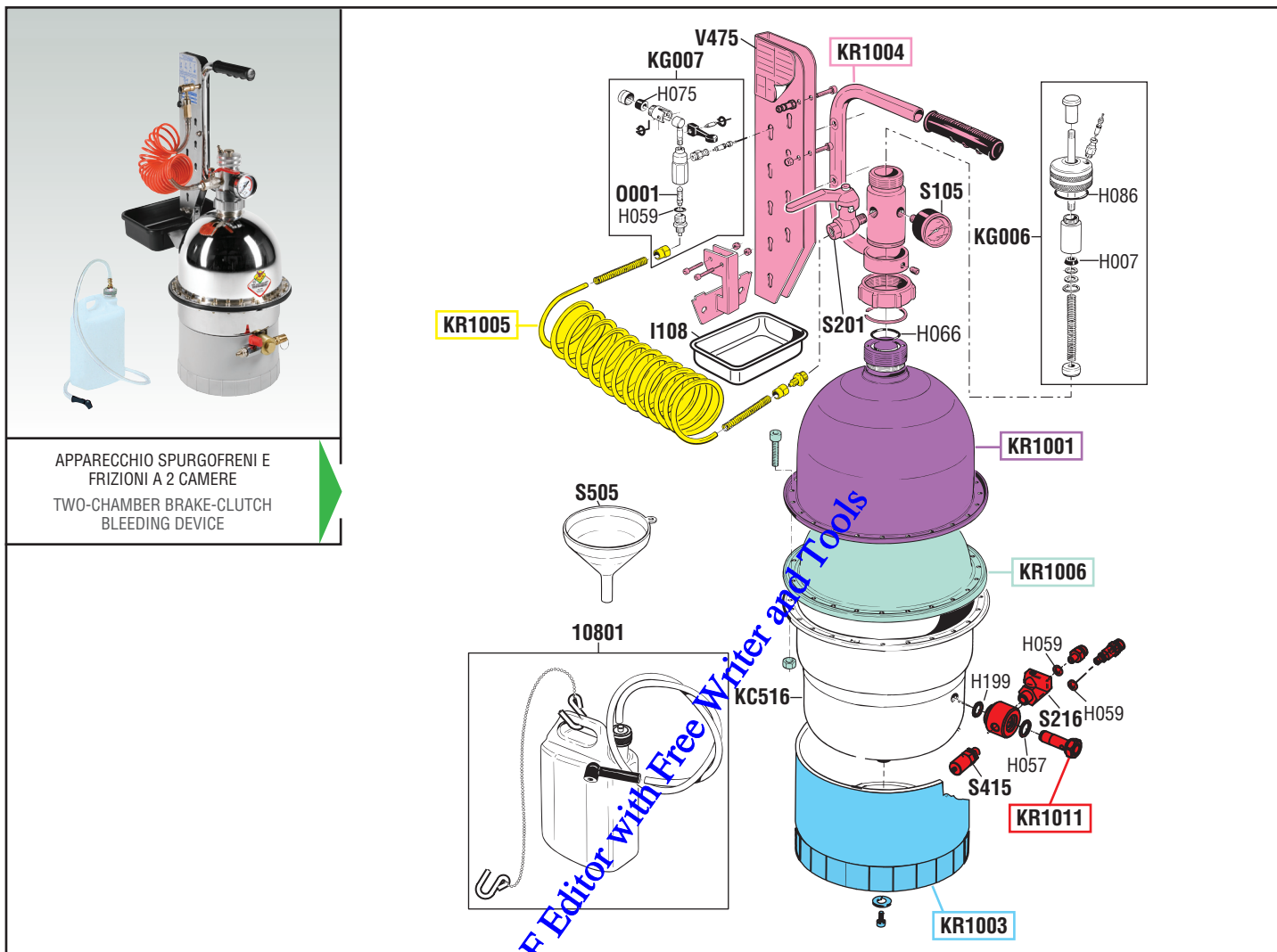

APPARECCHIO SPURGOFRENI E FRIZIONI A 2 CAMERE
TWO-CHAMBER BRAKE-CLUTCH BLEEDING DEVICE

GUIDA RICAMBI - SPARE PARTS GUIDE

KIT RICAMBI
OGNI KIT SOTTO RIPORTATO COMPRENDE I RICAMBI EVIDENZIATI CON LO STESSO COLORE E LE RELATIVE GUARNIZIONI. QUESTI RICAMBI NON SONO FORNIBILI SEPARATAMENTE TRANNE QUELLI CODIFICATI.

SPARE PARTS KITS
EACH KIT SHOWN WITH THE SAME COLOR INCLUDES ALSO THE GASKETS. THE SPARE PARTS INCLUDED IN THE KIT CAN'T BE SUPPLIED SEPARATELY EXCEPT THOSE SHOWN WITH A PROPER CODE.

CODICE CODE	DESCRIZIONE DESCRIPTION	Q.TÀ QTY
KR1001	CALOTTA SUPERIORE UPPER CAP	1
KR1003	PIEDISTALLO FOOT-STALL	1
KR1004	GRUPPO SUPERIORE COMPLETO COMPLETE UPPER GROUP	1
KR1005	TUBO COLLEGAMENTO CONNECTION HOSE	1
KR1006	MEMBRANA CON SET VITI MEMBRANE WITH SET OF SCREWS	1
KR1011	GRUPPO INFERIORE COMPLETO COMPLETE LOWER GROUP	1

ELENCO RICAMBI FORNIBILI SINGOLARMENTE
LIST OF SPARE PARTS WHICH CAN BE SUPPLIED SEPARATELY

CODICE CODE	DESCRIZIONE DESCRIPTION	Q.TÀ QTY
10801	TANICHETTA DI RECUPERO BRAKE FLUID COLLECTION CONTAINER	1
I108	VASCHETTA PORTA OGGETTI TOOL TRAY	1
KC516	SERBATOIO INFERIORE LOWER RESERVOIR	1
KG006	TAPPO CARICA OLIO OIL LEVEL INDICATOR	1
KG007	ATTACCO RAPIDO QUICK COUPLER	1
S105	MANOMETRO ø 50 mm GAUGE ø 50 mm	1
S201	RUBINETTO A SFERA 1/4" BALL VALVE 1/4"	1
S216	RUBINETTO A SFERA 1/4" BALL VALVE 1/4"	1
S415	VALVOLA DI SICUREZZA 3 bar SAFETY VALVE 3 bar	1
S505	IMBUTO RECUPERO OLIO FUNNEL	1
V475	ETICHETTA ELENCO TAPPI LABEL	1

Art. KR1050 KIT GUARNIZIONI COMPLETO
COMPOSTO DALLE GUARNIZIONI SOTTO ELENCAE
JOINTS GASKETS LIST
INCLUDING ALL THE GASKETS SHOWN HERE UNDER

CODICE CODE	DESCRIZIONE DESCRIPTION	Q.TÀ QTY
H007	GUARNIZIONE GASKET	1
H057	O-RING 2062 O-RING 2062	1
H059	O-RING 2037 O-RING 2037	1
H066	O-RING 3118 O-RING 3118	1
H068	O-RING 112 O-RING 112	1
H075	GUARNIZIONE ATTACCO RAPIDO QUICK CONNECTOR GASKET	1
H086	O-RING 4118 O-RING 4118	1
H199	O-RING 119 O-RING 119	1
O001	FILTRO ATTACCO RAPIDO QUICK CONNECTOR FILTER	1

Art. KS1081 SET RICAMBI CONSIGLIATI
AI PUNTI VENDITA E ASSISTENZA,
COMPOSTO DAI RICAMBI SOTTO ELENCAE
SPARE PARTS KIT ADVISED
TO THE REPAIR CENTERS. THIS KIT INCLUDES
ALL THE SPARE PARTS SHOWN HERE UNDER

CODICE CODE	DESCRIZIONE DESCRIPTION	Q.TÀ QTY
KR1006	MEMBRANA CON SET DI VITI MEMBRANE WITH SET OF SCREWS	1
KR1050	KIT GUARNIZIONI COMPLETO COMPLETE GASKETS KIT	1
S105	MANOMETRO ø 50 mm GAUGE ø 50 mm	1

tutti i diritti riservati - all rights reserved



Art. 10705 - Art. 10805 - Art. 10807 Mod. S.F.3C



VISTA ESPLOSA - EXPLODED VIEW

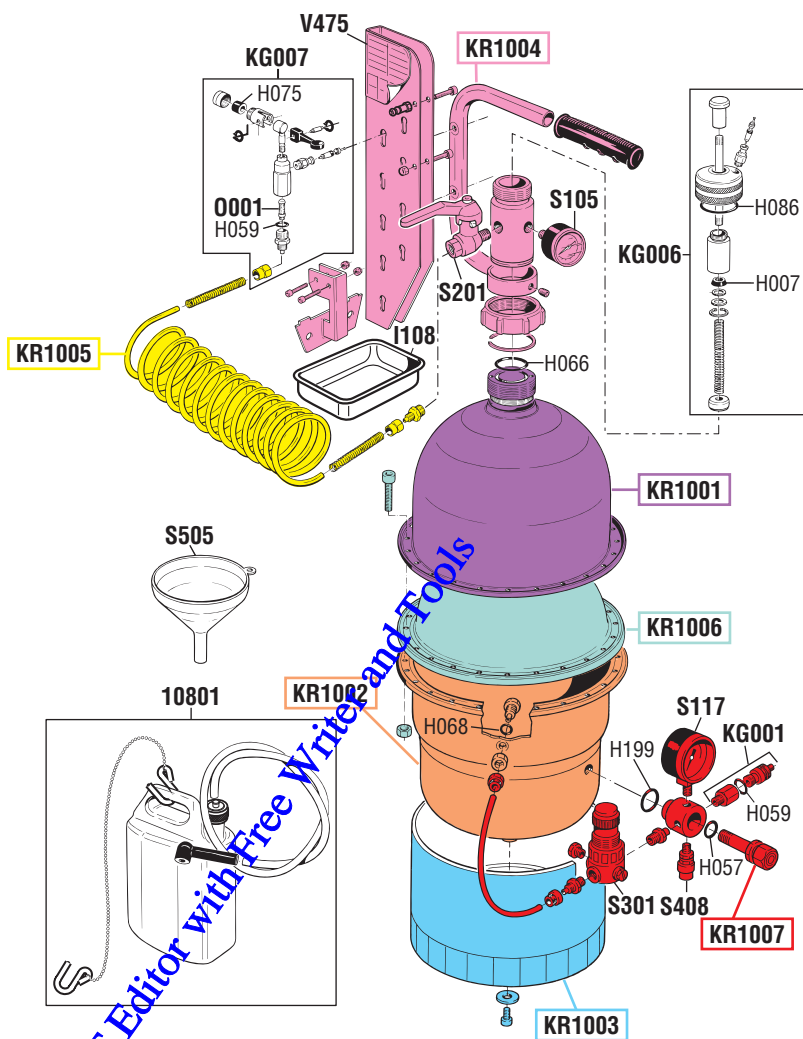

GUIDA RICAMBI - SPARE PARTS GUIDE

KIT RICAMBI
OGNI KIT SOTTO RIPORTATO COMPRENDE I RICAMBI EVIDENZIATI CON LO STESSO COLORE E LE RELATIVE GUARNIZIONI. QUESTI RICAMBI NON SONO FORNIBILI SEPARATAMENTE TRANNE QUELLI CODIFICATI.

SPARE PARTS KITS
EACH KIT SHOWN WITH THE SAME COLOR INCLUDES ALSO THE GASKETS. THE SPARE PARTS INCLUDED IN THE KIT CAN'T BE SUPPLIED SEPARATELY EXCEPT THOSE SHOWN WITH A PROPER CODE.

CODICE CODE	DESCRIZIONE DESCRIPTION	Q.TÀ QTY
KR1001	CALOTTA SUPERIORE UPPER CAP	1
KR1002	SERBATOIO ARIA AIR RESERVOIR	1
KR1003	PIEDISTALLO FOOT-STALL	1
KR1004	GRUPPO SUPERIORE COMPLETO COMPLETE UPPER GROUP	1
KR1005	TUBO COLLEGAMENTO CONNECTION HOSE	1
KR1006	MEMBRANA CON SET VITI MEMBRANE WITH SET OF SCREWS	1
KR1007	GRUPPO INFERIORE COMPLETO COMPLETE LOWER GROUP	1

ELENCO RICAMBI FORNIBILI SINGOLARMENTE
LIST OF SPARE PARTS WHICH CAN BE SUPPLIED SEPARATELY

CODICE CODE	DESCRIZIONE DESCRIPTION	Q.TÀ QTY
10801	TANICHETTA DI RECUPERO BRAKE FLUID COLLECTION CONTAINER	1
I108	VASCHETTA PORTA OGGETTI TOOL TRAY	1
KG001	RUBINETTO UNIVERSALE CARICA ARIA UNIVERSAL AIR TAP	1
KG006	TAPPO CARICA OLIO OIL LEVEL INDICATOR	1
KG007	ATTACCO RAPIDO QUICK COUPLER	1
S105	MANOMETRO ø 50 mm GAUGE ø 50 mm	1
S117	MANOMETRO ø 50 mm GAUGE ø 50 mm	1
S201	RUBINETTO A SFERA 1/4" BALL VALVE 1/4"	1
S301	REGOLATORE DI PRESSIONE 1/4" PRESSURE REGULATOR 1/4"	1
S408	VALVOLA SICUREZZA 10 bar SAFETY VALVE 10 bar	1
S505	IMBUTO RECUPERO OLIO FUNNEL	1
V475	ETICHETTA ELENCO TAPPI LABEL	1

Art. KR1050 KIT GUARNIZIONI COMPLETO
COMPOSTO DALLE GUARNIZIONI SOTTO ELENCAE JOINTS GASKETS LIST INCLUDING ALL THE GASKETS SHOWN HERE UNDER

CODICE CODE	DESCRIZIONE DESCRIPTION	Q.TÀ QTY
H007	GUARNIZIONE GASKET	1
H057	O-RING 2062 O-RING 2062	1
H059	O-RING 2037 O-RING 2037	1
H066	O-RING 3118 O-RING 3118	1
H068	O-RING 112 O-RING 112	1
H075	GUARNIZIONE ATTACCO RAPIDO QUICK CONNECTOR GASKET	1
H086	O-RING 4118 O-RING 4118	1
H199	O-RING 119 O-RING 119	1
O001	FILTRO ATTACCO RAPIDO QUICK CONNECTOR FILTER	1

Art. KS1080 SET RICAMBI CONSIGLIATI
AI PUNTI VENDITA E ASSISTENZA. COMPOSTO DAI RICAMBI SOTTO ELENCAE SPARE PARTS KIT ADVISED TO THE REPAIR CENTERS. THIS KIT INCLUDES ALL THE SPARE PARTS SHOWN HERE UNDER

CODICE CODE	DESCRIZIONE DESCRIPTION	Q.TÀ QTY
KR1006	MEMBRANA CON SET DI VITI MEMBRANE WITH SET OF SCREWS	1
KR1050	KIT GUARNIZIONI COMPLETO COMPLETE GASKETS KIT	1
S105	MANOMETRO ø 50 mm GAUGE ø 50 mm	1
S117	MANOMETRO ø 50 mm GAUGE ø 50 mm	1

tutti i diritti riservati - all rights reserved



Art. 11000/W



VISTA ESPLOSA - EXPLODED VIEW

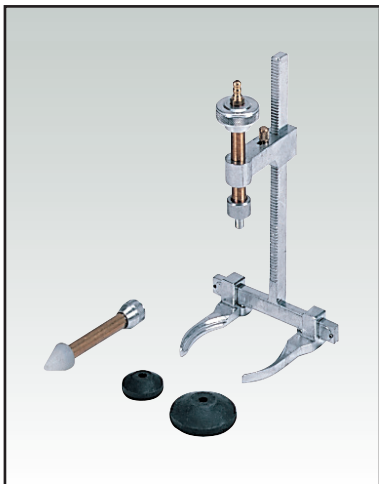

TAPPO UNIVERSALE W CON 3 TAMPONI CONICI
UNIVERSAL PLUG W WITH 3 TAPERED PLUGS

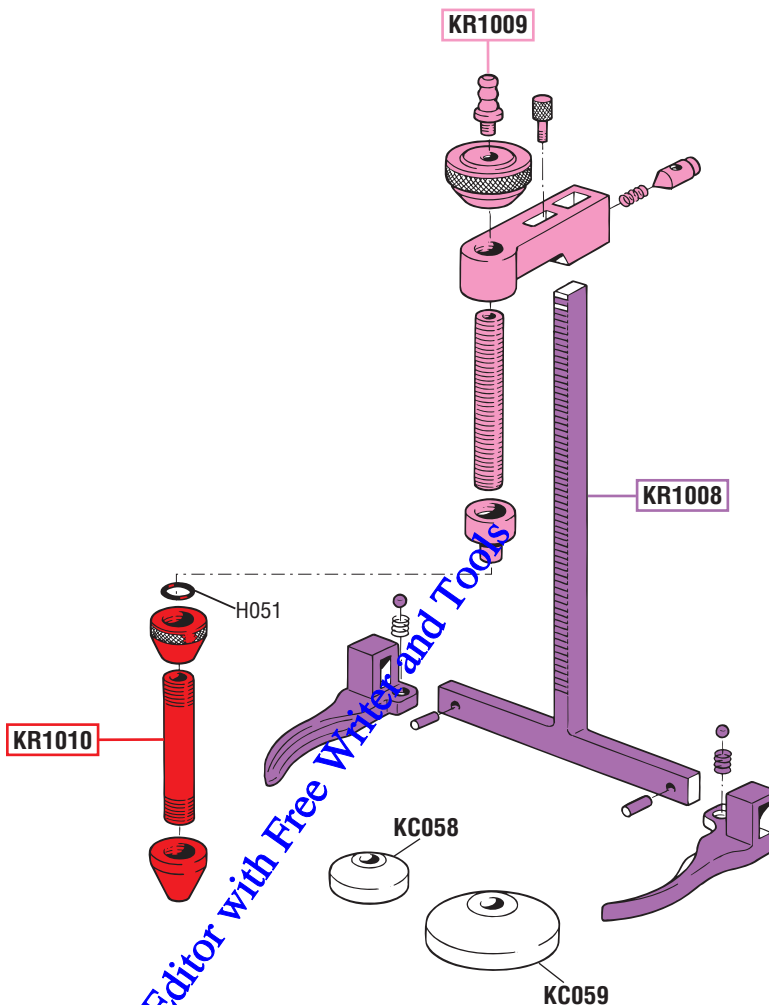

tutti i diritti riservati - all rights reserved

GUIDA RICAMBI - SPARE PARTS GUIDE

KIT RICAMBI

OGNI KIT SOTTO RIPORTATO COMPRENDE I RICAMBI EVIDENZIATI CON LO STESSO COLORE E LE RELATIVE GUARNIZIONI. QUESTI RICAMBI NON SONO FORNIBILI SEPARATAMENTE TRanne QUELLI CODIFICATI.

SPARE PARTS KITS

EACH KIT SHOWN WITH THE SAME COLOR INCLUDES ALSO THE GASKETS. THE SPARE PARTS INCLUDED IN THE KIT CAN'T BE SUPPLIED SEPARATELY EXCEPT THOSE SHOWN WITH A PROPER CODE.

CODICE CODE	DESCRIZIONE DESCRIPTION	Q.TÀ QTY
KR1008	SUPPORTO TAPPO UNIVERSALE PLUG SUPPORT	1
KR1009	PIEDISTALLO FOOT-STALL	1
KR1010	PROLUNGA TAPPO PLUG EXTENSION	1

ELENCO RICAMBI FORNIBILI SINGOLARMENTE

LIST OF SPARE PARTS WHICH CAN BE SUPPLIED SEPARATELY

CODICE CODE	DESCRIZIONE DESCRIPTION	Q.TÀ QTY
H051	O-RING 2031 O-RING 2031	1
KC058	TAMPONE VULCANIZZATO ø 33 mm VULCANIZED ADAPTER ø 33 mm	1
KC059	TAMPONE VULCANIZZATO ø 51,5 mm VULCANIZED ADAPTER ø 51,5 mm	1



Art. 11001 - Art. 11002



VISTA ESPLOSA - EXPLODED VIEW

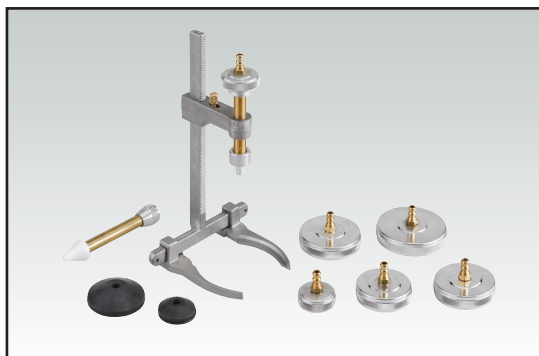

SERIE TAPPI DI RACCORDO A VITE STANDARD
E A VITE SPECIALI
SERIES OF STANDARD AND SPECIAL SCREWS
CONNECTION PLUGS

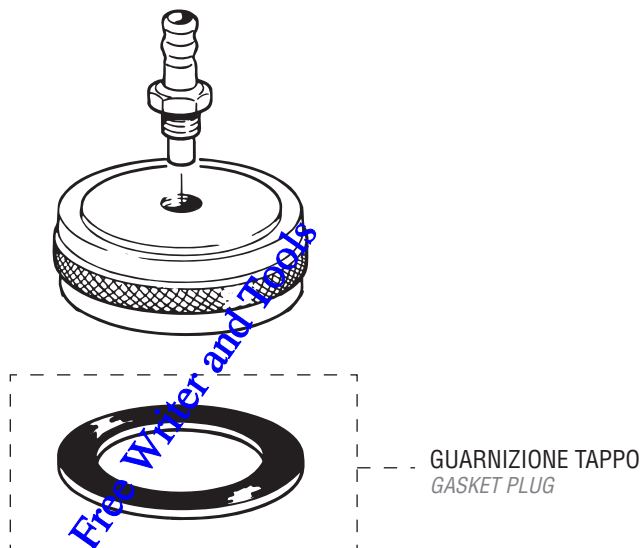

GUARNIZIONE TAPPO
GASKET PLUG

GUIDA RICAMBI - SPARE PARTS GUIDE

ELENCO RICAMBI FORNIBILI SINGOLARMENTE
LIST OF SPARE PARTS WHICH CAN BE SUPPLIED
SEPARATELY

CODICE CODE	DESCRIZIONE DESCRIPTION	Q.TÀ QTY
H106	GUARNIZIONE TAPPO A VITE STANDARD "A" (Art.11000/A) GASKET FOR STANDARD SCREW PLUG "A" (Art.11000/A)	1
H103	GUARNIZIONE TAPPO A VITE STANDARD "D" (Art.11000/D) GASKET FOR STANDARD SCREW PLUG "D" (Art.11000/D)	1
H111	GUARNIZIONE TAPPO A VITE STANDARD "F" (Art.11000/F) GASKET FOR STANDARD SCREW PLUG "F" (Art.11000/F)	1
H114	GUARNIZIONE TAPPO A VITE STANDARD "I" (Art.11000/I) GASKET FOR STANDARD SCREW PLUG "I" (Art.11000/I)	1
H121	GUARNIZIONE TAPPO A VITE STANDARD "T" (Art.11000/T) GASKET FOR STANDARD SCREW PLUG "T" (Art.11000/T)	1

ELENCO RICAMBI FORNIBILI SINGOLARMENTE
LIST OF SPARE PARTS WHICH CAN BE SUPPLIED
SEPARATELY

CODICE CODE	DESCRIZIONE DESCRIPTION	Q.TÀ QTY
H102	GUARNIZIONE TAPPO A VITE SPECIALE "B" (Art.11000/B) GASKET FOR SPECIAL SCREW PLUG "B" (Art.11000/B)	1
H108	GUARNIZIONE TAPPO A VITE SPECIALE "C" (Art.11000/C) GASKET FOR SPECIAL SCREW PLUG "C" (Art.11000/C)	1
H110	GUARNIZIONE TAPPO A VITE SPECIALE "E" (Art.11000/E) GASKET FOR SPECIAL SCREW PLUG "E" (Art.11000/E)	1
H112	GUARNIZIONE TAPPO A VITE SPECIALE "G" (Art.11000/G) GASKET FOR SPECIAL SCREW PLUG "G" (Art.11000/G)	1
H113	GUARNIZIONE TAPPO A VITE SPECIALE "H" (Art.11000/H) GASKET FOR SPECIAL SCREW PLUG "H" (Art.11000/H)	1
H115	GUARNIZIONE TAPPO A VITE SPECIALE "L" - "U" (Art.11000/L - Art.11000/U) GASKET FOR SPECIAL SCREW PLUG "L" - "U" (Art.11000/L - Art.11000/U)	1
H116	GUARNIZIONE TAPPO A VITE SPECIALE "M" (Art.11000/M) GASKET FOR SPECIAL SCREW PLUG "M" (Art.11000/M)	1
H117	GUARNIZIONE TAPPO A VITE SPECIALE "P" (Art.11000/P) GASKET FOR SPECIAL SCREW PLUG "P" (Art.11000/P)	1
H119	GUARNIZIONE TAPPO A VITE SPECIALE "R" - "Y" (Art.11000/R - Art.11000/Y) GASKET FOR SPECIAL SCREW PLUG "R" - "Y" (Art.11000/R - Art.11000/Y)	1
H114	GUARNIZIONE TAPPO A VITE SPECIALE "Z" (Art.11000/Z) GASKET FOR SPECIAL SCREW PLUG "Z" (Art.11000/Z)	1
H121	GUARNIZIONE TAPPO A VITE SPECIALE "X" (Art.11000/X) GASKET FOR SPECIAL SCREW PLUG "X" (Art.11000/X)	1
H219	GUARNIZIONE TAPPO A VITE SPECIALE "K" (Art.11000/K) GASKET FOR SPECIAL SCREW PLUG "K" (Art.11000/K)	1



Art. 11004



VISTA ESPLOSA - EXPLODED VIEW

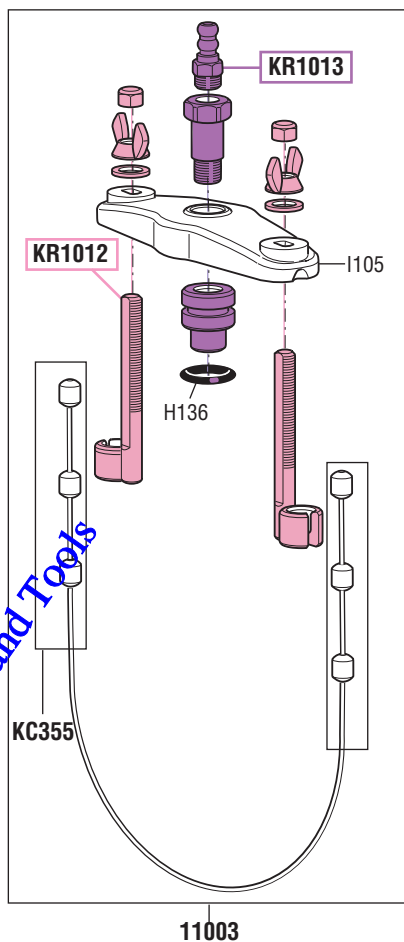
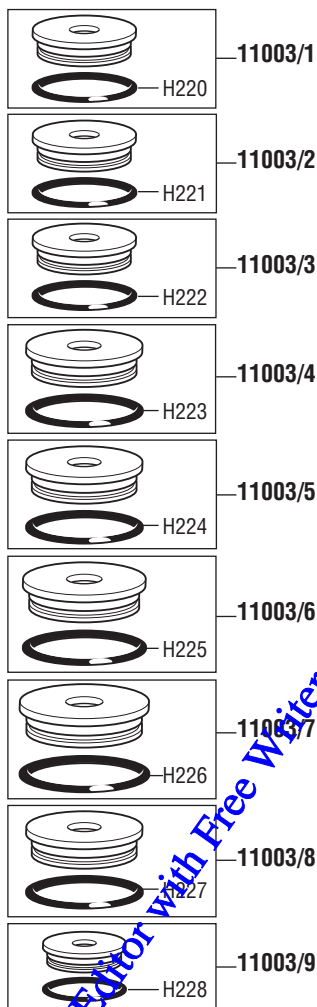
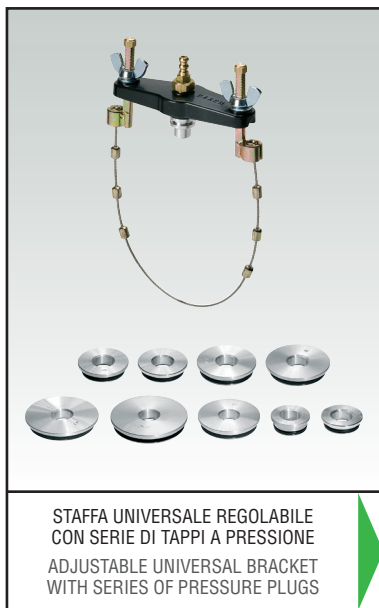

GUIDA RICAMBI - SPARE PARTS GUIDE

KIT RICAMBI
OGNI KIT SOTTO RIPORTATO COMPRENDE I RICAMBI EVIDENZIATI CON LO STESSO COLORE E LE RELATIVE GUARNIZIONI. QUESTI RICAMBI NON SONO FORNIBILI SEPARATAMENTE TRANNE QUELLI CODIFICATI.

SPARE PARTS KITS
EACH KIT SHOWN WITH THE SAME COLOR INCLUDES ALSO THE GASKETS. THE SPARE PARTS INCLUDED IN THE KIT CAN'T BE SUPPLIED SEPARATELY EXCEPT THOSE SHOWN WITH A PROPER CODE.

CODICE CODE	DESCRIZIONE DESCRIPTION	Q.TÀ QTY
KR1012	PERNO PORTA TAPPI PLUGS REST	1
KR1013	SUPPORTO TIRANTE PORTA CORDA REST FOR TIE ROD	1

ELENCO RICAMBI FORNIBILI SINGOLARMENTE
LIST OF SPARE PARTS WHICH CAN BE SUPPLIED SEPARATELY

CODICE CODE	DESCRIZIONE DESCRIPTION	Q.TÀ QTY
11003	STAFFA UNIVERSALE UNIVERSAL BRACKET	1
11003/1	TAPPO RACCORDO ø 42,2 - 42,5 mm UNION PLUG ø 42,2 - 42,5 mm	1
11003/2	TAPPO RACCORDO ø 42,8 mm UNION PLUG ø 42,8 mm	1
11003/3	TAPPO RACCORDO ø 53,8 - 54 mm UNION PLUG ø 53,8 - 54 mm	1
11003/4	TAPPO RACCORDO ø 56 mm UNION PLUG ø 56 mm	1
11003/5	TAPPO RACCORDO ø 65,7 mm UNION PLUG ø 65,7 mm	1
11003/6	TAPPO RACCORDO ø 74,2 mm UNION PLUG ø 74,2 mm	1
11003/7	TAPPO RACCORDO ø 58,8 mm UNION PLUG ø 58,8 mm	1
11003/8	TAPPO RACCORDO ø 33,7 mm UNION PLUG ø 33,7 mm	1
11003/9	TAPPO RACCORDO ø 35,8 mm UNION PLUG ø 35,8 mm	1
H136	O-RING 119 "VITON" O-RING 119 "VITON"	1
H220	O-RING 4137 "VITON" O-RING 4137 "VITON"	1
H221	O-RING 4131 "VITON" O-RING 4131 "VITON"	1
H222	O-RING 4187 "VITON" O-RING 4187 "VITON"	1
H223	O-RING 153 "VITON" O-RING 153 "VITON"	1
H224	O-RING 162 "VITON" O-RING 162 "VITON"	1
H225	O-RING 170 "VITON" O-RING 170 "VITON"	1
H226	O-RING 155 "VITON" O-RING 155 "VITON"	1

KIT GUARNIZIONI COMPLETO
COMPOSTO DALLE GUARNIZIONI SOTTO ELENCAITE
JOINTS GASKETS LIST
INCLUDING ALL THE GASKETS SHOWN HERE UNDER

CODICE CODE	DESCRIZIONE DESCRIPTION	Q.TÀ QTY
H227	O-RING 134 "VITON" O-RING 134 "VITON"	1
H228	O-RING 4112 "VITON" O-RING 4112 "VITON"	1
I105	SUPPORTO TAPPI PLUGS REST	1
KC355	CORDA AGGANCI CORD WITH HOOKS	1

tutti i diritti riservati - all rights reserved



Art. 11/60 - Art. 11/61 - Art. 11/62 - Art. 11/63 - Art. 11/64 - Art. 11/65



VISTA ESPLOSA - EXPLODED VIEW

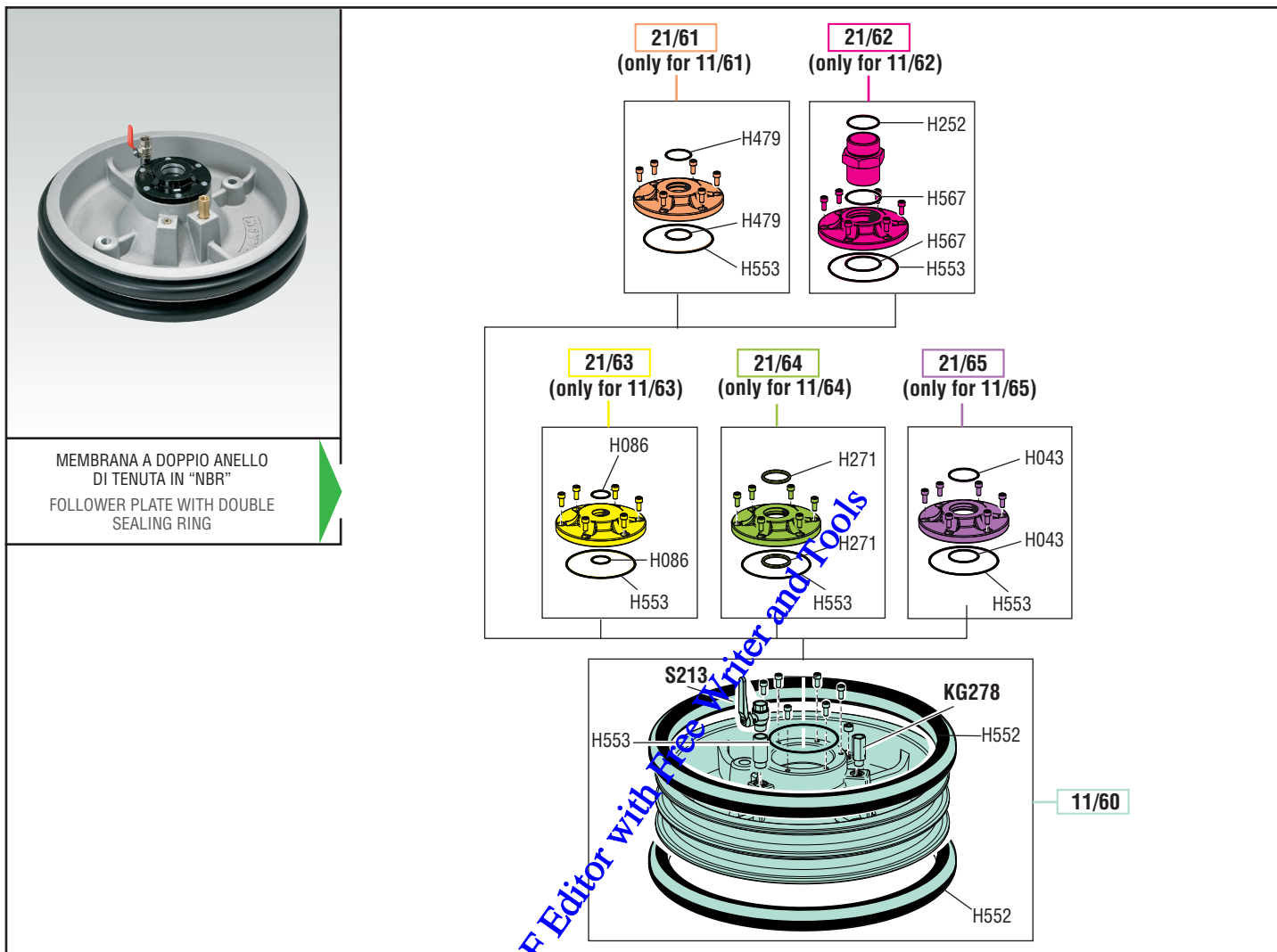

tutti i diritti riservati - all rights reserved

GUIDA RICAMBI - SPARE PARTS GUIDE

KIT RICAMBI
 OGNI KIT SOTTO RIPORTATO COMPRENDE I RICAMBI EVIDENZIATI CON LO STESSO COLORE E LE RELATIVE GUARNIZIONI. QUESTI RICAMBI NON SONO FORNIBILI SEPARATAMENTE TRAMIE QUELLI CODIFICATI.

SPARE PARTS KITS
 EACH KIT SHOWN WITH THE SAME COLOR INCLUDES ALSO THE GASKETS. THE SPARE PARTS INCLUDED IN THE KIT CAN'T BE SUPPLIED SEPARATELY EXCEPT THOSE SHOWN WITH A PROPER CODE.

CODICE CODE	DESCRIZIONE DESCRIPTION	Q.TÀ QTY
11/60	MEMBRANA ø 585 mm A DOPPIA GUARNIZIONE "NBR" "NBR" DOUBLE GASKET FOLLOWER PLATE ø 585 mm	1
21/61	ADATTATORE ø 43 mm PER PESCANTE 1" (per Art.11/61) ADAPTOR ø 43 mm FOR 1" SUCTION TUBE (for Art.11/61)	1
21/62	ADATTATORE F 2" G (per Art.11/62) ADAPTOR F 2" G (for Art.11/62)	1
21/63	ADATTATORE ø 30 mm (per Art.11/63) ADAPTOR ø 30 mm (for Art.11/63)	1
21/64	ADATTATORE ø 45 mm (per Art.11/64) ADAPTOR ø 45 mm (for Art.11/64)	1
21/65	ADATTATORE ø 50,8 mm (per Art.11/65) ADAPTOR ø 50,8 mm (for Art.11/65)	1

ELENCO RICAMBI FORNIBILI SINGOLARMENTE
 LIST OF SPARE PARTS WHICH CAN BE SUPPLIED SEPARATELY

CODICE CODE	DESCRIZIONE DESCRIPTION	Q.TÀ QTY
H043	O-RING 155 (per Art.11/65) O-RING 155 (for Art.11/65)	2
H086	O-RING 418 (per Art.11/63) O-RING 418 (for Art.11/63)	2
H252	O-RING 3212 (per Art.11/62) O-RING 3212 (for Art.11/62)	1
H271	O-RING 150 (per Art.11/64) O-RING 150 (for Art.11/64)	2
H479	O-RING 147 (per Art.11/61) O-RING 147 (for Art.11/61)	2
H552	GUARNIZIONE GASKET	2
H553	O-RING 3475 O-RING 3475	1
H567	O-RING 4237 (per Art.11/62) O-RING 4237 (for Art.11/62)	2
KG278	VALVOLA UNIDIREZIONALE VALVE	1
S213	RUBINETTO A SFERA 1/2" BALL VALVE 1/2"	1



Art. 115D/121 Mod. 1150D-12100



VISTA ESPLOSA - EXPLODED VIEW



POMPA DISSOCIATA S.1200
R. 12:1 - 30 l/min
DIVORCED PUMP S. 1200
R 12:1 - 30 l/min

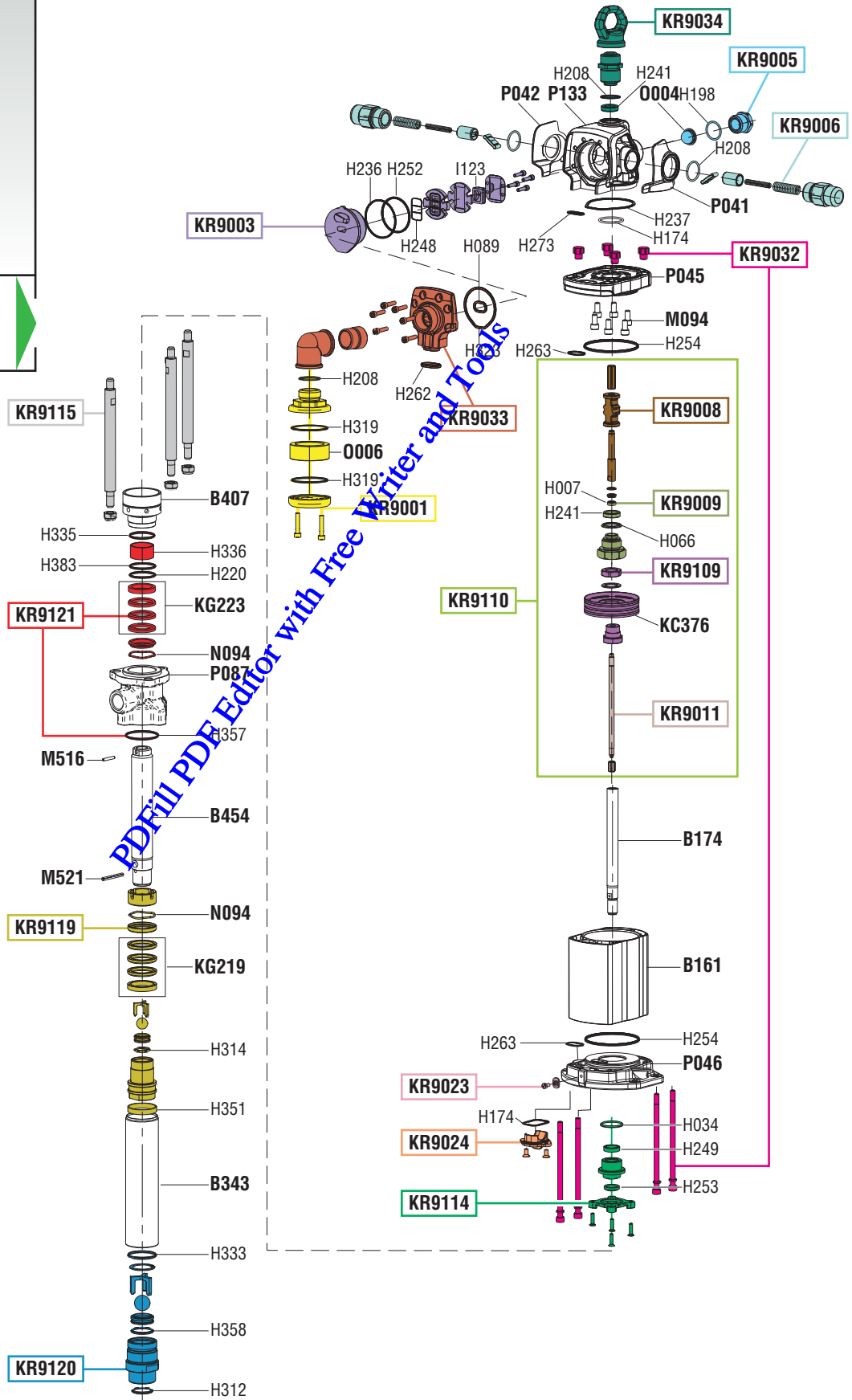

PDFfill PDF Editor with Free Writer and Tools

tutti i diritti riservati - all rights reserved

GUIDA RICAMBI - SPARE PARTS GUIDE

KIT RICAMBI OGNI KIT SOTTO RIPORTATO COMPRENDE I RICAMBI EVIDENZIATI CON LO STESSO COLORE E LE RELATIVE GUARNIZIONI. QUESTI RICAMBI NON SONO FORNIBILI SEPARATAMENTE TRANNE QUELLI CODIFICATI. SPARE PARTS KITS EACH KIT SHOWN WITH THE SAME COLOR INCLUDES ALSO THE GASKETS. THE SPARE PARTS INCLUDED IN THE KIT CAN'T BE SUPPLIED SEPARATELY EXCEPT THOSE SHOWN WITH A PROPER CODE.		
CODICE CODE	DESCRIZIONE DESCRIPTION	Q.TÀ QTY
KR9001	SILENZIATORE MUFFLER	1
KR9003	GRUPPO DISTRIBUTORE D'ARIA SLIDE VALVE GROUP	1
KR9005	RIDUZIONE ENTRATA AIR INLET CONNECTION	1
KR9006	BOSSOLI INVERTITORE BUSHES	1
KR9008	GRUPPO INVERTITORE PLUNGER GROUP	1
KR9009	TAPPO SUPERIORE UPPER PLUG	1
KR9011	ASTA INVERTITORE ROD	1
KR9023	MESSA A TERRA GROUNDED	1
KR9024	COLLETTORE MANIFOLD	1
KR9032	PRIGIONIERI STUD BOLTS	1
KR9033	COLLETTORE DI SCARICO DISCHARGE CONNECTION	1
KR9034	GOLFARO CON BOSSOLO GUIDA STELO BUSH	1
KR9109	PISTONE MOTORE AIR PISTON	1
KR9110	GRUPPO DISTRIBUZIONE DISTRIBUTION GROUP	1
KR9114	GRUPPO TENUTA INFERIORE LOWER SEAL GROUP	1
KR9115	PRIGIONIERI STUD BOLTS	1
KR9119	PISTONE POMPANTE PUMPING PISTON	1
KR9120	VALVOLA DI FONDO BOTTOM VALVE	1
KR9121	GRUPPO TENUTA INFERIORE LOWER SEAL GROUP	1

ELENCO RICAMBI FORNIBILI SINGOLARMENTE LIST OF SPARE PARTS WHICH CAN BE SUPPLIED SEPARATELY		
CODICE CODE	DESCRIZIONE DESCRIPTION	Q.TÀ QTY
B161	CILINDRO MOTORE MOTOR CYLINDER	1
B174	ALBERO PISTONE PISTON	1
B343	TUBO PESCANTE SUCTION TUBE	1
B407	GHIERA REGOLAZIONE REGULATING RING NUT	1
B454	STELO PESCANTE PUMPING ROD	1
KC376	PISTONE MOTORE PISTON	1
KG219	GUARNIZIONI GASKETS	1
KG223	GUARNIZIONI GASKETS	1
M094	VITE M8x20 SCREW M8x20	6
M516	SPINA ELASTICA PIN	1
M521	SPINA ELASTICA PIN	1
N094	MOLLA SPRING	2
O004	FILTRO ARIA AIR FILTER	1
O006	SILENZIATORE MUFFLER	1
P041	GUANCIA SINISTRA LEFT COVER	1
P042	GUANCIA DESTRA RIGHT COVER	1
P045	PIASTRA SUPERIORE UPPER FLANGE	1
P046	PIASTRA INFERIORE LOWER FLANGE	1
P087	CORPO INFERIORE LOWER BODY	1
P133	CORPO SUPERIORE UPPER BODY	1

KIT GUARNIZIONI COMPLETI TUTTE LE GUARNIZIONI (H...) MENZIONATE NELL'ESPLOSO SONO FORNIBILI ANCHE SINGOLARMENTE COMPLETE GASKETS KIT ALL THE O-RING (H...) MENTIONED IN THE EXPLODED VIEW CAN BE SUPPLIED SEPARATELY		
CODICE CODE	DESCRIZIONE DESCRIPTION	Q.TÀ QTY
KR9050	KIT GUARNIZIONI MOTORE SUPERIORE GASKETS KIT FOR UPPER MOTOR	1
KR9056	KIT GUARNIZIONI PISTONE ø 115 GASKETS KIT FOR PISTON ø 115	1
KR9156	KIT GUARNIZIONI MOTORE INFERIORE GASKETS KIT FOR LOWER MOTOR	1
KR9157	KIT GUARNIZIONI PESCANTE GASKETS KIT FOR SUCTION TUBE	1

Art. KS9184	SET RICAMBI CONSIGLIATI AI PUNTI VENDITA E ASSISTENZA, COMPOSTO DAI RICAMBI SOTTO ELENCATI. SPARE PARTS KIT ADVISED TO THE SELLING CENTERS. THIS KIT INCLUDES ALL THE SPARE PARTS SHOWN HERE UNDER.	
CODICE CODE	DESCRIZIONE DESCRIPTION	Q.TÀ QTY
KR9003	GRUPPO DISTRIBUZIONE ARIA SLIDE VALVE GROUP	1
KR9050	KIT GUARNIZIONI MOTORE SUPERIORE GASKETS KIT FOR UPPER MOTOR	1
KR9056	KIT GUARNIZIONI PISTONE ø 115 GASKETS KIT FOR PISTON ø 115	1
KR9156	KIT GUARNIZIONI MOTORE INFERIORE GASKETS KIT FOR LOWER MOTOR	1
KR9157	KIT GUARNIZIONI PESCANTE GASKETS KIT FOR SUCTION TUBE	1



Art. 115D/181 Mod. 1150D-18100



VISTA ESPLOSA - EXPLODED VIEW



POMPA DISSOCIATA S.1200
R. 18:1 - 23 l/min
DIVORCED PUMP S. 1200
R 18:1 - 23 l/min

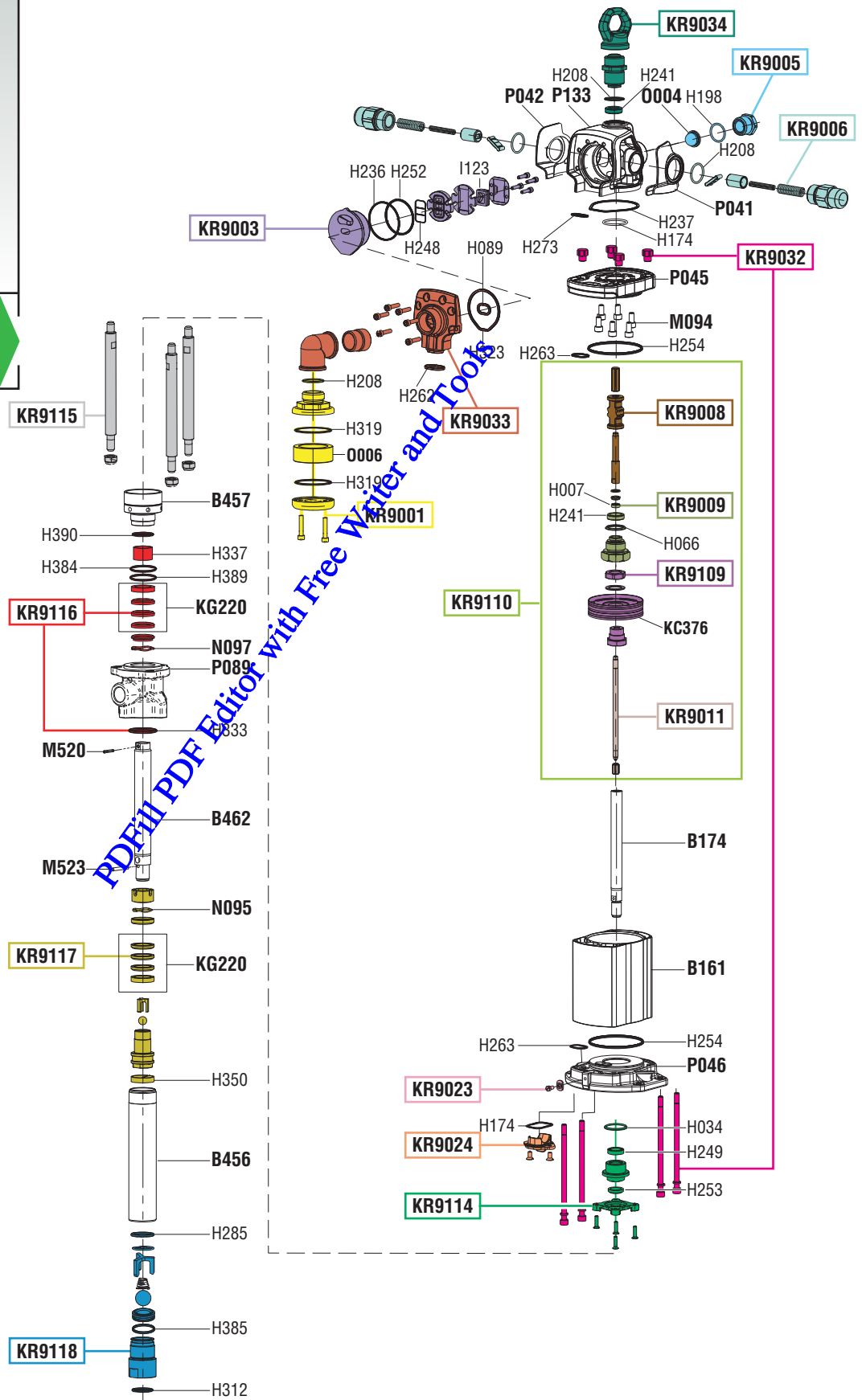

PDF FILE Editor with Free Writer and Tools

tutti i diritti riservati - all rights reserved

GUIDA RICAMBI - SPARE PARTS GUIDE

KIT RICAMBI OGNI KIT SOTTO RIPORTATO COMPRENDE I RICAMBI EVIDENZIATI CON LO STESSO COLORE E LE RELATIVE GUARNIZIONI. QUESTI RICAMBI NON SONO FORNIBILI SEPARATAMENTE TRANNE QUELLI CODIFICATI.		
SPARE PARTS KITS EACH KIT SHOWN WITH THE SAME COLOR INCLUDES ALSO THE GASKETS. THE SPARE PARTS INCLUDED IN THE KIT CAN'T BE SUPPLIED SEPARATELY EXCEPT THOSE SHOWN WITH A PROPER CODE.		
CODICE CODE	DESCRIZIONE DESCRIPTION	Q.TÀ QTY
KR9001	SILENZIATORE MUFFLER	1
KR9003	GRUPPO DISTRIBUTORE D'ARIA SLIDE VALVE GROUP	1
KR9005	RIDUZIONE ENTRATA AIR INLET CONNECTION	1
KR9006	BOSSOLI INVERTITORE BUSHES	1
KR9008	GRUPPO INVERTITORE PLUNGER GROUP	1
KR9009	TAPPO SUPERIORE UPPER PLUG	1
KR9011	ASTA INVERTITORE ROD	1
KR9023	MESSA A TERRA GROUNDED	1
KR9024	COLLETTORE MANIFOLD	1
KR9032	PRIGIONIERI STUD BOLTS	1
KR9033	COLLETTORE DI SCARICO DISCHARGE CONNECTION	1
KR9034	GOLFARO CON BOSSOLO GUIDA STELO BUSH	1
KR9109	PISTONE MOTORE AIR PISTON	1
KR9110	GRUPPO DISTRIBUZIONE DISTRIBUTION GROUP	1
KR9114	GRUPPO TENUTA INFERIORE LOWER SEAL GROUP	1
KR9115	PRIGIONIERI STUD BOLTS	1
KR9116	GRUPPO TENUTA INFERIORE LOWER SEAL GROUP	1
KR9117	PISTONE POMPANTE PUMPING PISTON	1
KR9118	VALVOLA DI FONDO BOTTOM VALVE	1

ELENCO RICAMBI FORNIBILI SINGOLARMENTE LIST OF SPARE PARTS WHICH CAN BE SUPPLIED SEPARATELY		
CODICE CODE	DESCRIZIONE DESCRIPTION	Q.TÀ QTY
B161	CILINDRO MOTORE MOTOR CYLINDER	1
B174	ALBERO PISTONE PISTON	1
B456	TUBO PESCANTE SUCTION TUBE	1
B457	GHIERA REGOLAZIONE REGULATING RING NUT	1
B462	STELO PESCANTE PUMPING ROD	1
KC376	PISTONE MOTORE PISTON	1
KG220	GUARNIZIONI GASKETS	2
M094	VITE M8x20 SCREW M8x20	6
M520	SPINA ELASTICA PIN	1
M523	SPINA ELASTICA PIN	1
N095	MOLLA SPRING	1
N097	MOLLA SPRING	1
O004	FILTRO ARIA AIR FILTER	1
O006	SILENZIATORE MUFFLER	1
P041	GUANCIA SINISTRA LEFT COVER	1
P042	GUANCIA DESTRA RIGHT COVER	1
P045	PIASTRA SUPERIORE UPPER FLANGE	1
P046	PIASTRA INFERIORE LOWER FLANGE	1
P089	CORPO INFERIORE LOWER BODY	1
P133	CORPO SUPERIORE UPPER BODY	1

KIT GUARNIZIONI COMPLETI TUTTE LE GUARNIZIONI (H...) MENZIONATE NELL'ESPLOSO SONO FORNIBILI ANCHE SINGOLARMENTE		
COMPLETE GASKETS KIT ALL THE O-RING (H...) MENTIONED IN THE EXPLODED VIEW CAN BE SUPPLIED SEPARATELY		
CODICE CODE	DESCRIZIONE DESCRIPTION	Q.TÀ QTY
KR9050	KIT GUARNIZIONI MOTORE SUPERIORE GASKETS KIT FOR UPPER MOTOR	1
KR9056	KIT GUARNIZIONI PISTONE ø 115 GASKETS KIT FOR PISTON ø 115	1
KR9154	KIT GUARNIZIONI MOTORE INFERIORE GASKETS KIT FOR LOWER MOTOR	1
KR9155	KIT GUARNIZIONI PESCANTE GASKETS KIT FOR SUCTION TUBE	1

Art. KS9183	SET RICAMBI CONSIGLIATI AI PUNTI VENDITA E ASSISTENZA, COMPOSTO DAI RICAMBI SOTTO ELENCATI.	
CODICE CODE	DESCRIZIONE DESCRIPTION	Q.TÀ QTY
	SPARE PARTS KIT ADVISED TO THE SELLING CENTERS. THIS KIT INCLUDES ALL THE SPARE PARTS SHOWN HERE UNDER.	
KR9003	GRUPPO DISTRIBUZIONE ARIA SLIDE VALVE GROUP	1
KR9050	KIT GUARNIZIONI MOTORE SUPERIORE GASKETS KIT FOR UPPER MOTOR	1
KR9056	KIT GUARNIZIONI PISTONE ø 115 GASKETS KIT FOR PISTON ø 115	1
KR9154	KIT GUARNIZIONI MOTORE INFERIORE GASKETS KIT FOR LOWER MOTOR	1
KR9155	KIT GUARNIZIONI PESCANTE GASKETS KIT FOR SUCTION TUBE	1

GUIDA RICAMBI - SPARE PARTS GUIDE

KIT RICAMBI

OGNI KIT SOTTO RIPORTATO COMPRENDE I RICAMBI EVIDENZIATI CON LO STESSO COLORE E LE RELATIVE GUARNIZIONI. QUESTI RICAMBI NON SONO FORNIBILI SEPARATAMENTE TRANNE QUELLI CODIFICATI.

SPARE PARTS KITS

EACH KIT SHOWN WITH THE SAME COLOR INCLUDES ALSO THE GASKETS. THE SPARE PARTS INCLUDED IN THE KIT CAN'T BE SUPPLIED SEPARATELY EXCEPT THOSE SHOWN WITH A PROPER CODE.

CODICE CODE	DESCRIZIONE DESCRIPTION	Q.TÀ QTY
KR9001	SILENZIATORE MUFFLER	1
KR9003	GRUPPO DISTRIBUTORE D'ARIA SLIDE VALVE GROUP	1
KR9005	RIDUZIONE ENTRATA AIR INLET CONNECTION	1
KR9006	BOSSOLI INVERTITORE BUSHES	1
KR9008	GRUPPO INVERTITORE PLUNGER GROUP	1
KR9009	TAPPO SUPERIORE UPPER PLUG	1
KR9011	ASTA INVERTITORE ROD	1
KR9023	MESSA A TERRA GROUNDED	1
KR9024	COLLETTORE MANIFOLD	1
KR9032	PRIGIONIERI STUD BOLTS	1
KR9033	COLLETTORE DI SCARICO DISCHARGE CONNECTION	1
KR9034	BOSSOLO GUIDA STELO BUSH	1
KR9109	PISTONE MOTORE AIR PISTON	1
KR9110	GRUPPO DISTRIBUZIONE DISTRIBUTION GROUP	1
KR9125	GRUPPO TENUTA SUPERIORE UPPER SEAL GROUP	1
KR9126	PRIGIONIERI STUD BOLTS	1
KR9127	GRUPPO TENUTA INFERIORE LOWER SEAL GROUP	1
KR9128	PISTONE POMPANTE PUMPING PISTON	1
KR9129	VALVOLA DI FONDO BOTTOM VALVE	1
KR9130	PRIGIONIERI STUD BOLTS	1

ELENCO RICAMBI FORNIBILI SINGOLARMENTE
LIST OF SPARE PARTS WHICH CAN BE SUPPLIED SEPARATELY

CODICE CODE	DESCRIZIONE DESCRIPTION	Q.TÀ QTY
B161	CILINDRO MOTORE MOTOR CYLINDER	1
B528	GHIERA CHIUSURA LOCKUP RING NUT	1
B529	TUBO PESCANTE SUCTION TUBE	1
B625	ALBERO PISTONE PISTON	1
KC376	PISTONE MOTORE PISTON	1
KC484	STELO POMPANTE PUMPING ROD	1
KG230	GUARNIZIONE PISTONE PISTON GASKET	1
M094	VITE M8x20 SCREW M8x20	6
M522	SPINA ELASTICA PIN	1
0004	FILTRO ARIA AIR FILTER	1
0006	SILENZIATORE MUFFLER	1
P041	GUANCIA SINISTRA LEFT COVER	1
P042	GUANCIA DESTRA RIGHT COVER	1
P045	PIASTRA SUPERIORE UPPER FLANGE	1
P046	PIASTRA INFERIORE LOWER FLANGE	1
P126	CORPO INFERIORE LOWER BODY	1
P128	CORPO INFERIORE PESCANTE LOWER SUCTION BODY	1
P133	CORPO SUPERIORE UPPER BODY	1

KIT GUARNIZIONI COMPLETI

TUTTE LE GUARNIZIONI (H...) MENZIONATE NELL'ESPLOSO SONO FORNIBILI ANCHE SINGOLARMENTE

COMPLETE GASKETS KIT

ALL THE O-RING (H...) MENTIONED IN THE EXPLODED VIEW CAN BE SUPPLIED SEPARATELY

CODICE CODE	DESCRIZIONE DESCRIPTION	Q.TÀ QTY
KR9050	KIT GUARNIZIONI MOTORE SUPERIORE GASKETS KIT FOR UPPER MOTOR	1
KR9056	KIT GUARNIZIONI PISTONE ø 115 GASKETS KIT FOR PISTON ø 115	1
KR9160	KIT GUARNIZIONI MOTORE INFERIORE GASKETS KIT FOR LOWER MOTOR	1
KR9161	KIT GUARNIZIONI PESCANTE GASKETS KIT FOR SUCTION TUBE	1

Art.
KS9091

SET RICAMBI CONSIGLIATI

AI PUNTI VENDITA E ASSISTENZA, COMPOSTO DAI RICAMBI SOTTO ELENCATI.

SPARE PARTS KIT ADVISED

TO THE SELLING CENTERS, THIS KIT INCLUDES ALL THE SPARE PARTS SHOWN HERE UNDER.

CODICE CODE	DESCRIZIONE DESCRIPTION	Q.TÀ QTY
KR9003	GRUPPO DISTRIBUZIONE ARIA SLIDE VALVE GROUP	1
KR9050	KIT GUARNIZIONI MOTORE SUPERIORE GASKETS KIT FOR UPPER MOTOR	1
KR9056	KIT GUARNIZIONI PISTONE ø 115 GASKETS KIT FOR PISTON ø 115	1
KR9160	KIT GUARNIZIONI MOTORE INFERIORE GASKETS KIT FOR LOWER MOTOR	1
KR9161	KIT GUARNIZIONI PESCANTE GASKETS KIT FOR SUCTION TUBE	1

PDFfill PDF Editor with Free Writer and Tools

GUIDA RICAMBI - SPARE PARTS GUIDE

KIT RICAMBI
OGNI KIT SOTTO RIPORTATO COMPRENDE I RICAMBI EVIDENZIATI CON LO STESSO COLORE E LE RELATIVE GUARNIZIONI. QUESTI RICAMBI NON SONO FORNIBILI SEPARATAMENTE TRANNE QUELLI CODIFICATI.

SPARE PARTS KITS

EACH KIT SHOWN WITH THE SAME COLOR INCLUDES ALSO THE GASKETS. THE SPARE PARTS INCLUDED IN THE KIT CAN'T BE SUPPLIED SEPARATELY EXCEPT THOSE SHOWN WITH A PROPER CODE.

CODICE CODE	DESCRIZIONE DESCRIPTION	Q.TÀ QTY
KR9001	SILENZIATORE MUFFLER	1
KR9003	GRUPPO DISTRIBUTORE D'ARIA SLIDE VALVE GROUP	1
KR9005	RIDUZIONE ENTRATA AIR INLET CONNECTION	1
KR9006	BOSSOLI INVERTITORE BUSHES	1
KR9008	GRUPPO INVERTITORE PLUNGER GROUP	1
KR9009	TAPPO SUPERIORE UPPER PLUG	1
KR9011	ASTA INVERTITORE ROD	1
KR9023	MESSA A TERRA GROUNDED	1
KR9024	COLLETTORE MANIFOLD	1
KR9032	PRIGIONIERI STUD BOLTS	1
KR9033	COLLETTORE DI SCARICO DISCHARGE CONNECTION	1
KR9034	GOLFARO CON BOSSOLO GUIDA STELO BUSH	1
KR9109	PISTONE MOTORE AIR PISTON	1
KR9110	GRUPPO DISTRIBUZIONE DISTRIBUTION GROUP	1
KR9114	GRUPPO TENUTA INFERIORE LOWER SEAL GROUP	1
KR9115	PRIGIONIERI STUD BOLTS	1
KR9122	GRUPPO TENUTA INFERIORE LOWER SEAL GROUP	1
KR9123	PISTONE POMPANTE PUMPING PISTON	1
KR9124	VALVOLA DI FONDO BOTTOM VALVE	1

ELENCO RICAMBI FORNIBILI SINGOLARMENTE
LIST OF SPARE PARTS WHICH CAN BE SUPPLIED SEPARATELY

CODICE CODE	DESCRIZIONE DESCRIPTION	Q.TÀ QTY
B161	CILINDRO MOTORE MOTOR CYLINDER	1
B174	ALBERO PISTONE PISTON	1
B344	TUBO PESCANTE SUCTION TUBE	1
B414	GHIERA REGOLAZIONE REGULATING RING NUT	1
B452	STELO PESCANTE PUMPING ROD	1
KC376	PISTONE MOTORE PISTON	1
KG215	GUARNIZIONI GASKETS	1
KG216	GUARNIZIONI GASKETS	1
M094	VITE M8x20 SCREW M8x20	6
M516	SPINA ELASTICA PIN	1
M522	SPINA ELASTICA PIN	1
N093	MOLLA SPRING	1
N096	MOLLA SPRING	1
0004	FILTRO ARIA AIR FILTER	1
0006	SILENZIATORE MUFFLER	1
P041	GUANCIA SINISTRA LEFT COVER	1
P042	GUANCIA DESTRA RIGHT COVER	1
P045	PIASTRA SUPERIORE UPPER FLANGE	1
P046	PIASTRA INFERIORE LOWER FLANGE	1
P086	CORPO INFERIORE LOWER BODY	1
P133	CORPO SUPERIORE UPPER BODY	1

KIT GUARNIZIONI COMPLETI

TUTTE LE GUARNIZIONI (H...) MENZIONATE NELL'ESPLOSO SONO FORNIBILI ANCHE SINGOLARMENTE

COMPLETE GASKETS KIT

ALL THE O-RING (H...) MENTIONED IN THE EXPLODED VIEW CAN BE SUPPLIED SEPARATELY

CODICE CODE	DESCRIZIONE DESCRIPTION	Q.TÀ QTY
KR9050	KIT GUARNIZIONI MOTORE SUPERIORE GASKETS KIT FOR UPPER MOTOR	1
KR9056	KIT GUARNIZIONI PISTONE ø 115 GASKETS KIT FOR PISTON ø 115	1
KR9158	KIT GUARNIZIONI MOTORE INFERIORE GASKETS KIT FOR LOWER MOTOR	1
KR9159	KIT GUARNIZIONI PESCANTE GASKETS KIT FOR SUCTION TUBE	1

Art.
KS9185

SET RICAMBI CONSIGLIATI

AI PUNTI VENDITA E ASSISTENZA, COMPOSTO DAI RICAMBI SOTTO ELENCATI.

SPARE PARTS KIT ADVISED

TO THE SELLING CENTERS. THIS KIT INCLUDES ALL THE SPARE PARTS SHOWN HERE UNDER.

CODICE CODE	DESCRIZIONE DESCRIPTION	Q.TÀ QTY
KR9003	GRUPPO DISTRIBUZIONE ARIA SLIDE VALVE GROUP	1
KR9050	KIT GUARNIZIONI MOTORE SUPERIORE GASKETS KIT FOR UPPER MOTOR	1
KR9056	KIT GUARNIZIONI PISTONE ø 115 GASKETS KIT FOR PISTON ø 115	1
KR9158	KIT GUARNIZIONI MOTORE INFERIORE GASKETS KIT FOR LOWER MOTOR	1
KR9159	KIT GUARNIZIONI PESCANTE GASKETS KIT FOR SUCTION TUBE	1

RAASM

FLUIDS AND LUBRICATION EQUIPMENT



Art. 115DV/31 Mod. 1150DV-3100



VISTA ESPLOSA - EXPLODED VIEW



POMPA DISSOCIATA S.1200
R. 3:1 - 100 l/min - "Viton"
DIVORCED PUMP S.1200
R. 3:1 - 100 l/min - "Viton"

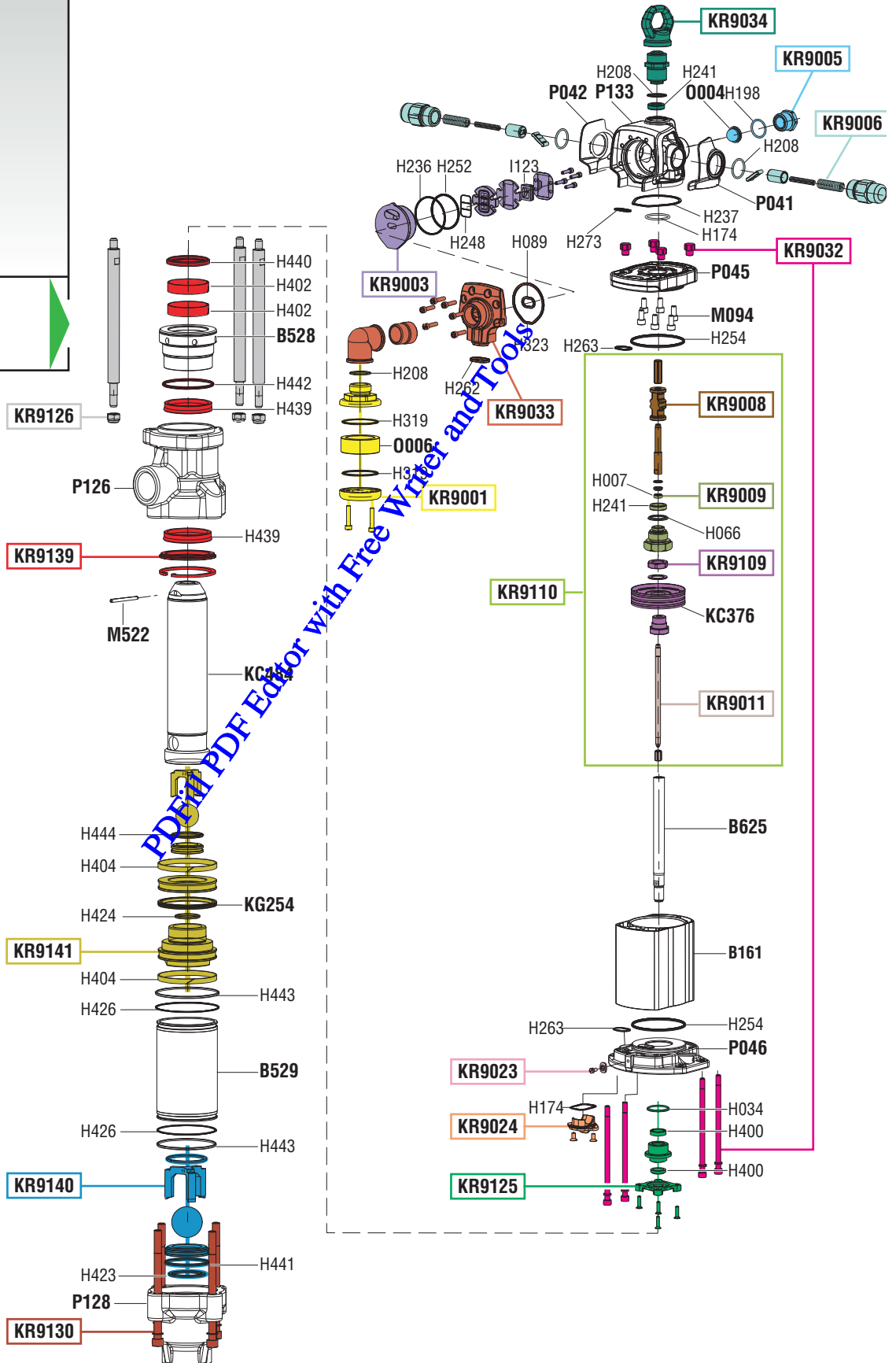

PDF Editor with Free Writer and Tools

tutti i diritti riservati - all rights reserved

GUIDA RICAMBI - SPARE PARTS GUIDE

KIT RICAMBI

OGNI KIT SOTTO RIPORTATO COMPRENDE I RICAMBI EVIDENZIATI CON LO STESSO COLORE E LE RELATIVE GUARNIZIONI. QUESTI RICAMBI NON SONO FORNIBILI SEPARATAMENTE TRANNE QUELLI CODIFICATI.

SPARE PARTS KITS

EACH KIT SHOWN WITH THE SAME COLOR INCLUDES ALSO THE GASKETS. THE SPARE PARTS INCLUDED IN THE KIT CAN'T BE SUPPLIED SEPARATELY EXCEPT THOSE SHOWN WITH A PROPER CODE.

CODICE CODE	DESCRIZIONE DESCRIPTION	Q.TÀ QTY
KR9001	SILENZIATORE MUFFLER	1
KR9003	GRUPPO DISTRIBUTORE D'ARIA SLIDE VALVE GROUP	1
KR9005	RIDUZIONE ENTRATA AIR INLET CONNECTION	1
KR9006	BOSSOLI INVERTITORE BUSHES	1
KR9008	GRUPPO INVERTITORE PLUNGER GROUP	1
KR9009	TAPPO SUPERIORE UPPER PLUG	1
KR9011	ASTA INVERTITORE ROD	1
KR9023	MESSA A TERRA GROUNDED	1
KR9024	COLLETTORE MANIFOLD	1
KR9032	PRIGIONIERI STUD BOLTS	1
KR9033	COLLETTORE DI SCARICO DISCHARGE CONNECTION	1
KR9034	BOSSOLO GUIDA STELO BUSH	1
KR9109	PISTONE MOTORE AIR PISTON	1
KR9110	GRUPPO DISTRIBUZIONE DISTRIBUTION GROUP	1
KR9125	GRUPPO TENUTA SUPERIORE UPPER SEAL GROUP	1
KR9126	PRIGIONIERI STUD BOLTS	1
KR9130	PRIGIONIERI STUD BOLTS	1
KR9139	GRUPPO TENUTA INFERIORE LOWER SEAL GROUP	1
KR9140	VALVOLA DI FONDO BOTTOM VALVE	1
KR9141	PISTONE POMPANTE PUMPING PISTON	1

ELENCO RICAMBI FORNIBILI SINGOLARMENTE LIST OF SPARE PARTS WHICH CAN BE SUPPLIED SEPARATELY

CODICE CODE	DESCRIZIONE DESCRIPTION	Q.TÀ QTY
B161	CILINDRO MOTORE MOTOR CYLINDER	1
B528	GHIERA CHIUSURA LOCKUP RING NUT	1
B529	TUBO PESCANTE SUCTION TUBE	1
B625	ALBERO PISTONE PISTON	1
KC376	PISTONE MOTORE PISTON	1
KC484	STELO POMPANTE PUMPING ROD	1
KG254	GUARNIZIONE PISTONE PISTON GASKET	1
M094	VITE M8x20 SCREW M8x20	6
M522	SPINA ELASTICA PIN	1
0004	FILTRO ARIA AIR FILTER	1
0006	SILENZIATORE MUFFLER	1
P041	GUANCIA SINISTRA LEFT COVER	1
P042	GUANCIA DESTRA RIGHT COVER	1
P045	PIASTRA SUPERIORE UPPER FLANGE	1
P046	PIASTRA INFERIORE LOWER FLANGE	1
P126	CORPO INFERIORE LOWER BODY	1
P128	CORPO INFERIORE PESCANTE LOWER SUCTION BODY	1
P133	CORPO SUPERIORE UPPER BODY	1

KIT GUARNIZIONI COMPLETI

TUTTE LE GUARNIZIONI (H...) MENZIONATE NELL'ESPLOSO SONO FORNIBILI ANCHE SINGOLARMENTE

COMPLETE GASKETS KIT

ALL THE O-RING (H...) MENTIONED IN THE EXPLODED VIEW CAN BE SUPPLIED SEPARATELY

CODICE CODE	DESCRIZIONE DESCRIPTION	Q.TÀ QTY
KR9050	KIT GUARNIZIONI MOTORE SUPERIORE GASKETS KIT FOR UPPER MOTOR	1
KR9056	KIT GUARNIZIONI PISTONE ø 115 GASKETS KIT FOR PISTON ø 115	1
KR9164	KIT GUARNIZIONI MOTORE INFERIORE GASKETS KIT FOR LOWER MOTOR	1
KR9165	KIT GUARNIZIONI PESCANTE GASKETS KIT FOR SUCTION TUBE	1

Art.
KS9092

SET RICAMBI CONSIGLIATI

AI PUNTI VENDITA E ASSISTENZA, COMPOSTO DAI RICAMBI SOTTO ELENCATI.

SPARE PARTS KIT ADVISED

TO THE SELLING CENTERS, THIS KIT INCLUDES ALL THE SPARE PARTS SHOWN HERE UNDER.

CODICE CODE	DESCRIZIONE DESCRIPTION	Q.TÀ QTY
KR9003	GRUPPO DISTRIBUZIONE ARIA SLIDE VALVE GROUP	1
KR9050	KIT GUARNIZIONI MOTORE SUPERIORE GASKETS KIT FOR UPPER MOTOR	1
KR9056	KIT GUARNIZIONI PISTONE ø 115 GASKETS KIT FOR PISTON ø 115	1
KR9164	KIT GUARNIZIONI MOTORE INFERIORE GASKETS KIT FOR LOWER MOTOR	1
KR9165	KIT GUARNIZIONI PESCANTE GASKETS KIT FOR SUCTION TUBE	1

RAASM

FLUIDS AND LUBRICATION EQUIPMENT



Art. 115F/121 Mod. 1150F-12100 - Art. 116F/121 Mod. 1150F-12194

VISTA ESPLOSA - EXPLODED VIEW

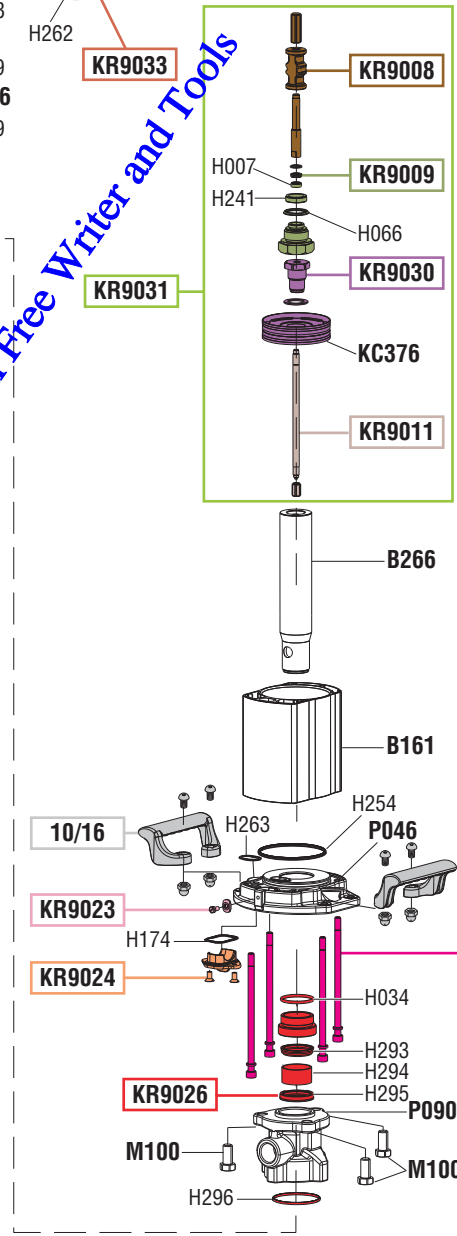
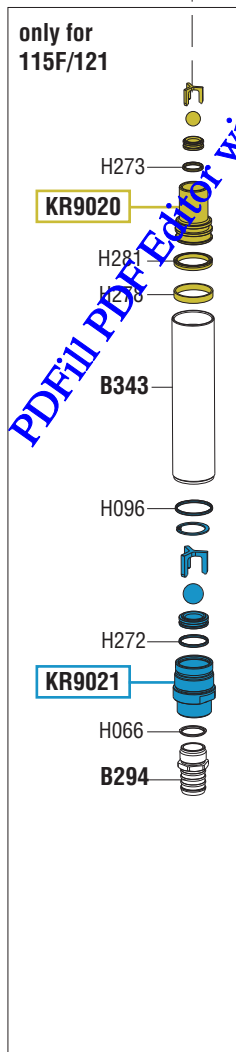
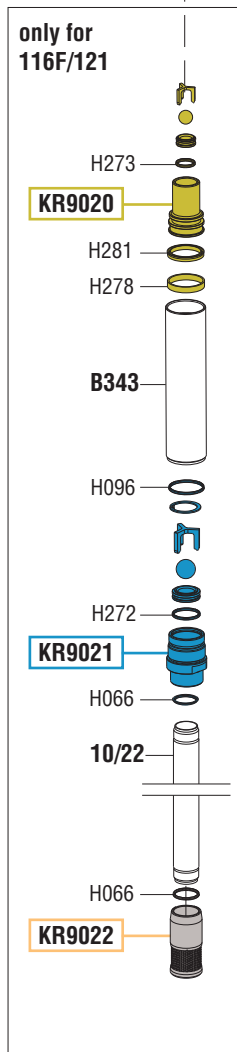
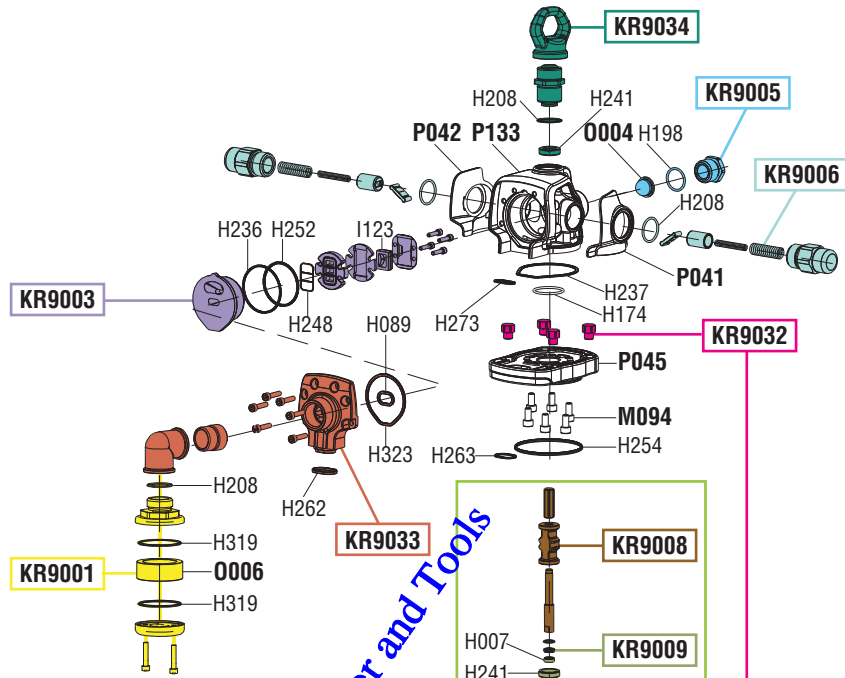
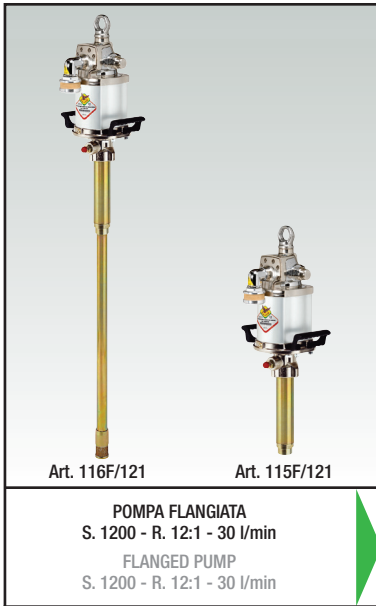

PDFFill PDF Editor with Free Writer and Tools

tutti i diritti riservati - all rights reserved

GUIDA RICAMBI - SPARE PARTS GUIDE

KIT RICAMBI OGNI KIT SOTTO RIPORTATO COMPRENDE I RICAMBI EVIDENZIATI CON LO STESSO COLORE E LE RELATIVE GUARNIZIONI. QUESTI RICAMBI NON SONO FORNIBILI SEPARATAMENTE TRANNE QUELLI CODIFICATI.		
SPARE PARTS KITS EACH KIT SHOWN WITH THE SAME COLOR INCLUDES ALSO THE GASKETS. THE SPARE PARTS INCLUDED IN THE KIT CAN'T BE SUPPLIED SEPARATELY EXCEPT THOSE SHOWN WITH A PROPER CODE.		
CODICE CODE	DESCRIZIONE DESCRIPTION	Q.TÀ QTY
10/16	MANIGLIE HANDLES	1
KR9001	SILENZIATORE MUFFLER	1
KR9003	GRUPPO DISTRIBUTORE D'ARIA SLIDE VALVE GROUP	1
KR9005	RIDUZIONE ENTRATA AIR INLET CONNECTION	1
KR9006	BOSSOLI INVERTITORE BUSHES	1
KR9008	GRUPPO INVERTITORE PLUNGER GROUP	1
KR9009	TAPPO SUPERIORE UPPER PLUG	1
KR9011	ASTA INVERTITORE ROD	1
KR9020	PISTONE POMPANTE PUMPING PISTON	1
KR9021	VALVOLA DI FONDO BOTTOM VALVE	1
KR9022	FILTRO PESCANTE SHANK FILTER	1
KR9023	MESSA A TERRA GROUNDED	1
KR9024	COLLETTORE MANIFOLD	1
KR9026	GRUPPO TENUTA INFERIORE LOWER SEAL GROUP	1
KR9030	PISTONE MOTORE AIR PISTON	1
KR9031	GRUPPO DISTRIBUZIONE DISTRIBUTION GROUP	1
KR9032	PRIGIONIERI STUD BOLTS	1
KR9033	COLLETTORE DI SCARICO DISCHARGE CONNECTION	1
KR9034	GOLFARO CON BOSSOLO GUIDA STELO BUSH	1

ELENCO RICAMBI FORNIBILI SINGOLARMENTE LIST OF SPARE PARTS WHICH CAN BE SUPPLIED SEPARATELY		
CODICE CODE	DESCRIZIONE DESCRIPTION	Q.TÀ QTY
10/22	PROLUNGA ø 34 mm EXTENSION ø 34 mm	
B161	CILINDRO MOTORE MOTOR CYLINDER	1
B266	STELO POMPANTE ROD	1
B294	PORTA TUBO HOSE CONNECTION	1
B343	TUBO PESCANTE SUCTION TUBE	1
KC376	PISTONE MOTORE PISTON	1
M094	VITE M8x20 SCREW M8x20	6
M100	VITE M12x25 SCREW M12x25	3
0004	FILTRO ARIA AIR FILTER	1
0006	SILENZIATORE MUFFLER	1
P041	GUANCIA SINISTRA LEFT COVER	1
P042	GUANCIA DESTRA RIGHT COVER	1
P045	PIASTRA SUPERIORE UPPER FLANGE	1
P046	PIASTRA INFERIORE LOWER FLANGE	1
P090	CORPO INFERIORE LOWER BODY	1
P133	CORPO SUPERIORE UPPER BODY	1

KIT GUARNIZIONI COMPLETI TUTTE LE GUARNIZIONI (H...) MENZIONATE NELL'ESPLOSO SONO FORNIBILI ANCHE SINGOLARMENTE		
COMPLETE GASKETS KIT ALL THE O-RING (H...) MENTIONED IN THE EXPLODED VIEW CAN BE SUPPLIED SEPARATELY		
CODICE CODE	DESCRIZIONE DESCRIPTION	Q.TÀ QTY
KR9050	KIT GUARNIZIONI MOTORE SUPERIORE GASKETS KIT FOR UPPER MOTOR	1
KR9054	KIT GUARNIZIONI PESCANTE GASKETS KIT FOR SUCTION TUBE	1
KR9056	KIT GUARNIZIONI PISTONE ø 115 GASKETS KIT FOR PISTON ø 115	1
KR9058	GRUPPO TENUTA INFERIORE LOWER SEAL GROUP	1

Art. KS9085	SET RICAMBI CONSIGLIATI AI PUNTI VENDITA E ASSISTENZA, COMPOSTO DAI RICAMBI SOTTO ELENCATI. SPARE PARTS KIT ADVISED TO THE SELLING CENTERS. THIS KIT INCLUDES ALL THE SPARE PARTS SHOWN HERE UNDER.	
CODICE CODE	DESCRIZIONE DESCRIPTION	Q.TÀ QTY
KR9003	GRUPPO DISTRIBUZIONE ARIA SLIDE VALVE GROUP	1
KR9050	KIT GUARNIZIONI MOTORE SUPERIORE GASKETS KIT FOR UPPER MOTOR	1
KR9054	KIT GUARNIZIONI PESCANTE GASKETS KIT FOR SUCTION TUBE	1
KR9056	KIT GUARNIZIONI PISTONE ø 115 GASKETS KIT FOR PISTON ø 115	1
KR9058	GRUPPO TENUTA INFERIORE LOWER SEAL GROUP	1

PDFill PDF Editor with Free Writer and Tools

GUIDA RICAMBI - SPARE PARTS GUIDE

KIT RICAMBI

OGNI KIT SOTTO RIPORTATO COMPRENDE I RICAMBI EVIDENZIATI CON LO STESSO COLORE E LE RELATIVE GUARNIZIONI. QUESTI RICAMBI NON SONO FORNIBILI SEPARATAMENTE TRANNE QUELLI CODIFICATI.

SPARE PARTS KITS

EACH KIT SHOWN WITH THE SAME COLOR INCLUDES ALSO THE GASKETS. THE SPARE PARTS INCLUDED IN THE KIT CAN'T BE SUPPLIED SEPARATELY EXCEPT THOSE SHOWN WITH A PROPER CODE.

CODICE CODE	DESCRIZIONE DESCRIPTION	Q.TÀ QTY
10/16	MANIGLIE HANDLES	1
KR9001	SILENZIATORE MUFFLER	1
KR9003	GRUPPO DISTRIBUTORE D'ARIA SLIDE VALVE GROUP	1
KR9005	RIDUZIONE ENTRATA AIR INLET CONNECTION	1
KR9006	BOSSOLI INVERTITORE BUSHES	1
KR9008	GRUPPO INVERTITORE PLUNGER GROUP	1
KR9009	TAPPO SUPERIORE UPPER PLUG	1
KR9011	ASTA INVERTITORE ROD	1
KR9023	MESSA A TERRA GROUNDED	1
KR9024	COLLETTORE MANIFOLD	1
KR9027	GRUPPO TENUTA INFERIORE LOWER SEAL GROUP	1
KR9028	PISTONE POMPANTE PUMPING PISTON	1
KR9029	VALVOLA DI FONDO BOTTOM VALVE	1
KR9030	PISTONE MOTORE AIR PISTON	1
KR9031	GRUPPO DISTRIBUZIONE DISTRIBUTION GROUP	1
KR9032	PRIGIONIERI STUD BOLTS	1
KR9033	COLLETTORE DI SCARICO DISCHARGE CONNECTION	1
KR9034	GOLFARO BOSSOLO GUIDA STELO BUSH	1

ELENCO RICAMBI FORNIBILI SINGOLARMENTE

LIST OF SPARE PARTS WHICH CAN BE SUPPLIED SEPARATELY

CODICE CODE	DESCRIZIONE DESCRIPTION	Q.TÀ QTY
B161	CILINDRO MOTORE MOTOR CYLINDER	1
B439	STELO MOTORE ROD	1
B441	TUBO PESCANTE SUCTION TUBE	1
B638	STELO PESCANTE ROD	1
B639	TUBO PESCANTE SUCTION TUBE	1
B687	STELO PESCANTE ROD	1
KC376	PISTONE MOTORE PISTON	1
M094	VITE M8x20 SCREW M8x20	6
M100	VITE M12X25 SCREW M12X25	3
M502	SPINA ELASTICA PIN	1
0004	FILTRO ARIA AIR FILTER	1
0006	SILENZIATORE MUFFLER	1
P041	GUANCIA SINISTRA LEFT COVER	1
P042	GUANCIA DESTRA RIGHT COVER	1
P045	PIASTRA SUPERIORE UPPER FLANGE	1
P046	PIASTRA INFERIORE LOWER FLANGE	1
P088	CORPO INFERIORE LOWER BODY	1
P133	CORPO SUPERIORE UPPER BODY	1

KIT GUARNIZIONI COMPLETI

TUTTE LE GUARNIZIONI (H...) MENZIONATE NELL'ESPLOSO SONO FORNIBILI ANCHE SINGOLARMENTE

COMPLETE GASKETS KIT

ALL THE O-RING (H...) MENTIONED IN THE EXPLODED VIEW CAN BE SUPPLIED SEPARATELY

CODICE CODE	DESCRIZIONE DESCRIPTION	Q.TÀ QTY
KR9050	KIT GUARNIZIONI MOTORE SUPERIORE GASKETS KIT FOR UPPER MOTOR	1
KR9056	KIT GUARNIZIONI PISTONE ø 115 GASKETS KIT FOR PISTON ø 115	1
KR9059	GRUPPO TENUTA INFERIORE LOWER SEAL GROUP	1
KR9060	KIT GUARNIZIONI PESCANTE GASKETS KIT FOR SUCTION TUBE	1

Art.
KS9087

SET RICAMBI CONSIGLIATI

AI PUNTI VENDITA E ASSISTENZA, COMPOSTO DAI RICAMBI SOTTO ELENCATI.

SPARE PARTS KIT ADVISED

TO THE SELLING CENTERS, THIS KIT INCLUDES ALL THE SPARE PARTS SHOWN HERE UNDER.

CODICE CODE	DESCRIZIONE DESCRIPTION	Q.TÀ QTY
KR9003	GRUPPO DISTRIBUZIONE ARIA SLIDE VALVE GROUP	1
KR9050	KIT GUARNIZIONI MOTORE SUPERIORE GASKETS KIT FOR UPPER MOTOR	1
KR9056	KIT GUARNIZIONI PISTONE ø 115 GASKETS KIT FOR PISTON ø 115	1
KR9059	GRUPPO TENUTA INFERIORE LOWER SEAL GROUP	1
KR9060	KIT GUARNIZIONI PESCANTE GASKETS KIT FOR SUCTION TUBE	1

PDFfill PDF Editor with Free Writer and Tools



Art. 115F/401 Mod. 1150F-40174 - Art. 116F/401 Mod. 1150F-40194
Art. 117F/401 Mod. 1150F-40184



VISTA ESPLOSA - EXPLODED VIEW

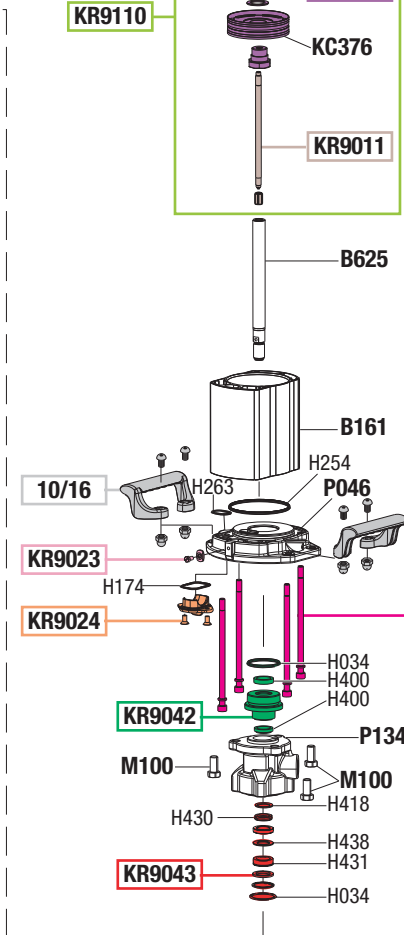
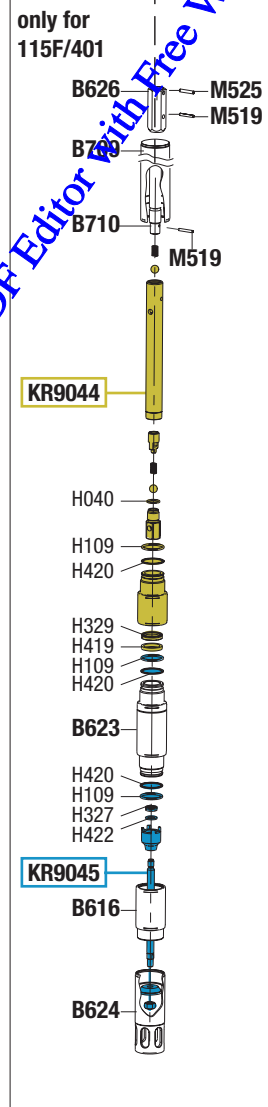
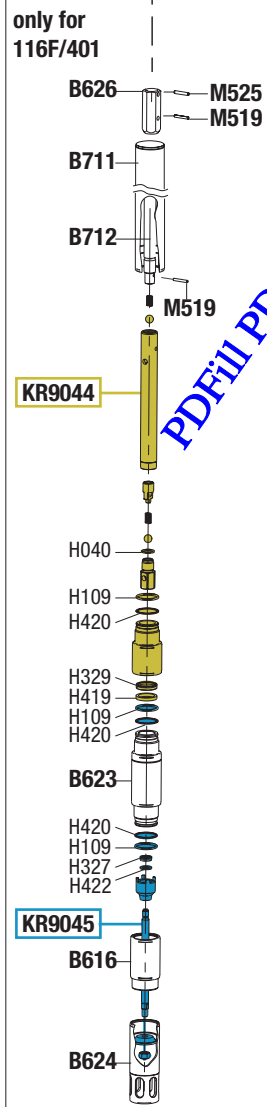
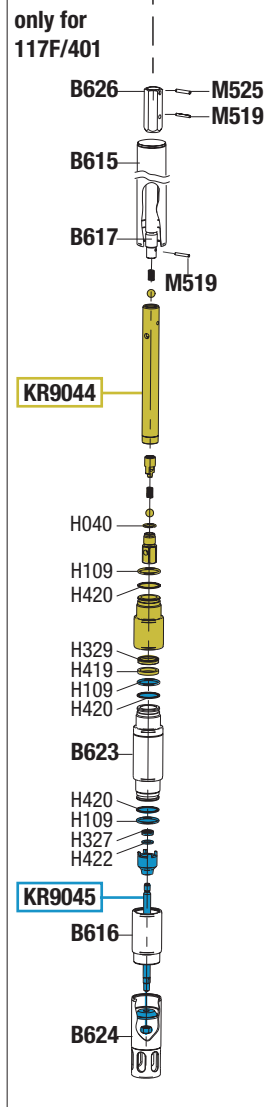
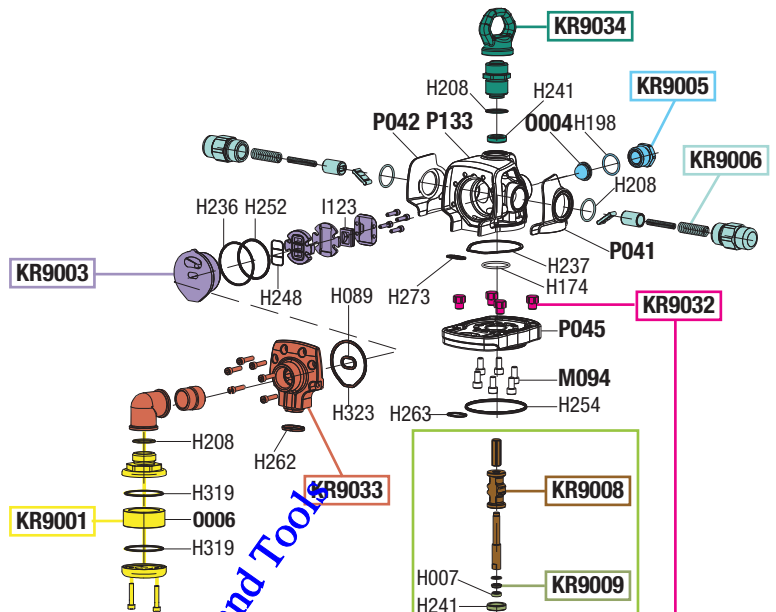
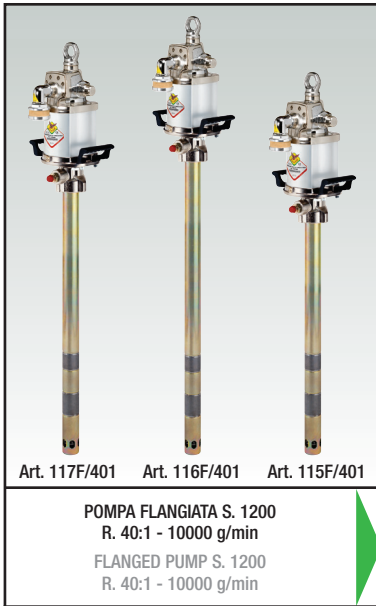

tutti i diritti riservati - all rights reserved

GUIDA RICAMBI - SPARE PARTS GUIDE

KIT RICAMBI
OGNI KIT SOTTO RIPIORTATO COMPRENDE I RICAMBI EVIDENZIATI CON LO STESSO COLORE E LE RELATIVE GUARNIZIONI. QUESTI RICAMBI NON SONO FORNIBILI SEPARATAMENTE TRAMME QUELLI CODIFICATI.

SPARE PARTS KITS

EACH KIT SHOWN WITH THE SAME COLOR INCLUDES ALSO THE GASKETS. THE SPARE PARTS INCLUDED IN THE KIT CAN'T BE SUPPLIED SEPARATELY EXCEPT THOSE SHOWN WITH A PROPER CODE.

CODICE CODE	DESCRIZIONE DESCRIPTION	Q.TÀ QTY
10/16	MANIGLIE HANDLES	1
KR9001	SILENZIATORE MUFFLER	1
KR9003	GRUPPO DISTRIBUTORE D'ARIA SLIDE VALVE GROUP	1
KR9005	RIDUZIONE ENTRATA AIR INLET CONNECTION	1
KR9006	BOSSOLI INVERTITORE BUSHES	1
KR9008	GRUPPO INVERTITORE PLUNGER GROUP	1
KR9009	TAPPO SUPERIORE UPPER PLUG	1
KR9011	ASTA INVERTITORE ROD	1
KR9023	MESSA A TERRA GROUNDED	1
KR9024	COLLETTORE MANIFOLD	1
KR9032	PRIGIONIERI STUD BOLTS	1
KR9033	COLLETTORE DI SCARICO DISCHARGE CONNECTION	1
KR9034	GOLFARO CON BOSSOLO GUIDA STELO BUSH	1
KR9042	GRUPPO TENUTA SUPERIORE UPPER SEAL GROUP	1
KR9043	GRUPPO TENUTA INFERIORE LOWER SEAL GROUP	1
KR9044	GRUPPO POMPANTE PUMPING GROUP	1
KR9045	FILTRO PESCANTE SHANK FILTER	1
KR9109	PISTONE MOTORE AIR PISTON	1
KR9110	GRUPPO DISTRIBUZIONE DISTRIBUTION GROUP	1

ELENCO RICAMBI FORNIBILI SINGOLARMENTE LIST OF SPARE PARTS WHICH CAN BE SUPPLIED SEPARATELY

CODICE CODE	DESCRIZIONE DESCRIPTION	Q.TÀ QTY
B161	CILINDRO MOTORE MOTOR CYLINDER	1
B615	TUBO PESCANTE SUCTION TUBE	1
B616	CILINDRO BATTUTA VALVOLA BOTTOM VALVE CYLINDER	1
B617	STELO POMPANTE PUMPING ROD	1
B623	PROLUNGA PESCANTE SUCTION TUBE EXTENSION	1
B624	TERMINALE PESCANTE SHANK END	1
B625	ALBERO PISTONE PISTON	1
B626	GIUNTO MOTORE MOTOR COUPLING	1
B709	TUBO PESCANTE SUCTION TUBE	1
B710	STELO POMPANTE PUMPING ROD	1
B711	TUBO PESCANTE SUCTION TUBE	1
B712	STELO POMPANTE PUMPING ROD	1
KC376	PISTONE MOTORE PISTON	1
M094	VITE M8x20 SCREW M8x20	6
M100	VITE M12x25 SCREW M12x25	3
M519	SPINA ELASTICA PIN	2
M525	SPINA ELASTICA PIN	1
0004	FILTRO ARIA AIR FILTER	1
0006	SILENZIATORE MUFFLER	1
P041	GUANCIA SINISTRA LEFT COVER	1
P042	GUANCIA DESTRA RIGHT COVER	1
P045	PIASTRA SUPERIORE UPPER FLANGE	1
P046	PIASTRA INFERIORE LOWER FLANGE	1
P131	CORPO SUPERIORE UPPER BODY	1
P132	CORPO INFERIORE LOWER BODY	1

KIT GUARNIZIONI COMPLETI

TUTTE LE GUARNIZIONI (H...) MENZIONATE NELL'ESPLOSO SONO FORNIBILI ANCHE SINGOLARMENTE

COMPLETE GASKETS KIT

ALL THE O-RING (H...) MENTIONED IN THE EXPLODED VIEW CAN BE SUPPLIED SEPARATELY

CODICE CODE	DESCRIZIONE DESCRIPTION	Q.TÀ QTY
KR9050	KIT GUARNIZIONI MOTORE SUPERIORE GASKETS KIT FOR UPPER MOTOR	1
KR9056	KIT GUARNIZIONI PISTONE ø 90 GASKETS KIT FOR PISTON ø 90	1
KR9065	KIT GUARNIZIONI MOTORE INFERIORE GASKETS KIT FOR LOWER MOTOR	1
KR9066	KIT GUARNIZIONI PESCANTE GASKETS KIT FOR SUCTION TUBE	1

Art.
KS9189

SET RICAMBI CONSIGLIATI

AI PUNTI VENDITA E ASSISTENZA, COMPOSTO DAI RICAMBI SOTTO ELENCATI.

SPARE PARTS KIT ADVISED

TO THE SELLING CENTERS. THIS KIT INCLUDES ALL THE SPARE PARTS SHOWN HERE UNDER.

CODICE CODE	DESCRIZIONE DESCRIPTION	Q.TÀ QTY
KR9003	GRUPPO DISTRIBUZIONE ARIA SLIDE VALVE GROUP	1
KR9050	KIT GUARNIZIONI MOTORE SUPERIORE GASKETS KIT FOR UPPER MOTOR	1
KR9056	KIT GUARNIZIONI PISTONE ø 90 GASKETS KIT FOR PISTON ø 90	1
KR9065	KIT GUARNIZIONI PESCANTE GASKETS KIT FOR SUCTION TUBE	1
KR9066	KIT GUARNIZIONI MOTORE INFERIORE GASKETS KIT FOR LOWER MOTOR	1

RAASM

FLUIDS AND LUBRICATION EQUIPMENT



Art. 115F/751 Mod. 1150F-75150 - Art. 115FSP/751 Mod. 1150FSP-75150

VISTA ESPLOSA - EXPLODED VIEW

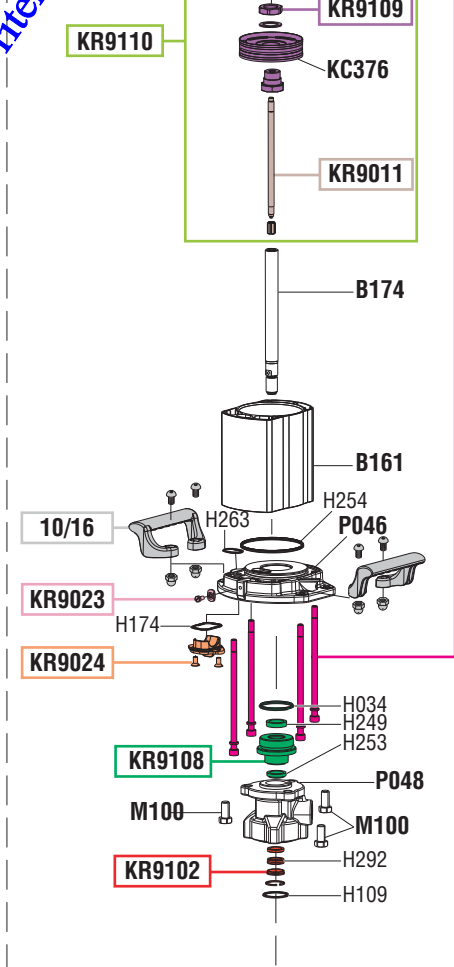
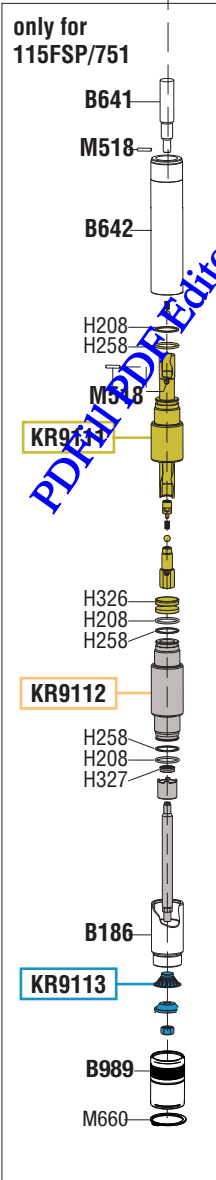
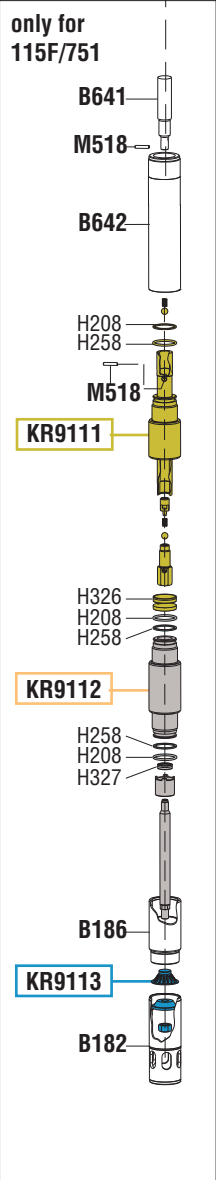
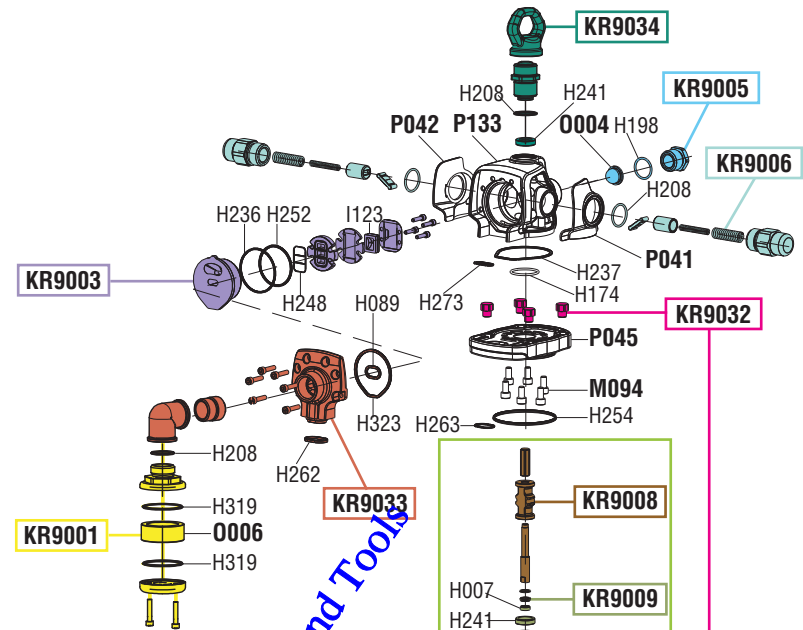

PDF Editor with Free Water and Tools

tutti i diritti riservati - all rights reserved

GUIDA RICAMBI - SPARE PARTS GUIDE

KIT RICAMBI

OGNI KIT SOTTO RIPORTATO COMPRENDE I RICAMBI EVIDENZIATI CON LO STESSO COLORE E LE RELATIVE GUARNIZIONI. QUESTI RICAMBI NON SONO FORNIBILI SEPARATAMENTE TRANNE QUELLI CODIFICATI.

SPARE PARTS KITS

EACH KIT SHOWN WITH THE SAME COLOR INCLUDES ALSO THE GASKETS. THE SPARE PARTS INCLUDED IN THE KIT CAN'T BE SUPPLIED SEPARATELY EXCEPT THOSE SHOWN WITH A PROPER CODE.

CODICE CODE	DESCRIZIONE DESCRIPTION	Q.TÀ QTY
10/16	MANIGLIE HANDLES	1
KR9001	SILENZIATORE MUFFLER	1
KR9003	GRUPPO DISTRIBUTORE D'ARIA SLIDE VALVE GROUP	1
KR9005	RIDUZIONE ENTRATA AIR INLET CONNECTION	1
KR9006	BOSSOLI INVERTITORE BUSHES	1
KR9008	GRUPPO INVERTITORE PLUNGER GROUP	1
KR9009	TAPPO SUPERIORE UPPER PLUG	1
KR9011	ASTA INVERTITORE ROD	1
KR9023	MESSA A TERRA GROUNDED	1
KR9024	COLLETTORE MANIFOLD	1
KR9032	PRIGIONIERI STUD BOLTS	1
KR9033	COLLETTORE DI SCARICO DISCHARGE CONNECTION	1
KR9034	GOLFARO CON BOSSOLO GUIDA STELO BUSH	1
KR9102	GRUPPO TENUTA INFERIORE LOWER SEAL GROUP	1
KR9108	GRUPPO TENUTA SUPERIORE UPPER SEAL GROUP	1
KR9109	PISTONE MOTORE AIR PISTON	1
KR9110	GRUPPO DISTRIBUZIONE DISTRIBUTION GROUP	1
KR9111	GRUPPO POMPANTE PUMPING GROUP	1
KR9112	GRUPPO PREPOMPAGGIO PUMPING GROUP	1
KR9113	FILTRO PESCANTE SHANK FILTER	1

ELENCO RICAMBI FORNIBILI SINGOLARMENTE
LIST OF SPARE PARTS WHICH CAN BE SUPPLIED SEPARATELY

CODICE CODE	DESCRIZIONE DESCRIPTION	Q.TÀ QTY
B161	CILINDRO MOTORE MOTOR CYLINDER	1
B174	ALBERO PISTONE PISTON	1
B182	TERMINALE PESCANTE SHANK END	1
B186	CILINDRO BATTUTA VALVOLA BOTTOM VALVE CYLINDER	1
B641	STELO POMPANTE PUMPING ROD	1
B642	TUBO PESCANTE SUCTION TUBE	1
B989	TERMINALE PESCANTE SHANK END	1
KC376	PISTONE MOTORE PISTON	1
M094	VITE M8x20 SCREW M8x20	6
M100	VITE M12x25 SCREW M12x25	3
M518	SPINA ELASTICA PIN	3
M660	SEGER SEGER	1
0004	FILTRO ARIA AIR FILTER	1
0006	SILENZIATORE MUFFLER	1
P041	GUANCIA SINISTRA LEFT COVER	1
P042	GUANCIA DESTRA RIGHT COVER	1
P045	PIASTRA SUPERIORE UPPER FLANGE	1
P046	PIASTRA INFERIORE LOWER FLANGE	1
P048	CORPO INFERIORE LOWER BODY	1
P133	CORPO SUPERIORE UPPER BODY	1

KIT GUARNIZIONI COMPLETI

TUTTE LE GUARNIZIONI (H...) MENZIONATE NELL'ESPLOSO SONO FORNIBILI ANCHE SINGOLARMENTE

COMPLETE GASKETS KIT

ALL THE O-RING (H...) MENTIONED IN THE EXPLODED VIEW CAN BE SUPPLIED SEPARATELY

CODICE CODE	DESCRIZIONE DESCRIPTION	Q.TÀ QTY
KR9050	KIT GUARNIZIONI MOTORE SUPERIORE GASKETS KIT FOR UPPER MOTOR	1
KR9056	KIT GUARNIZIONI PISTONE ø 115 GASKETS KIT FOR PISTON ø 115	1
KR9152	KIT GUARNIZIONI MOTORE INFERIORE GASKETS KIT FOR LOWER MOTOR	1
KR9153	KIT GUARNIZIONI PESCANTE GASKETS KIT FOR SUCTION TUBE	1

Art.
KS9182

SET RICAMBI CONSIGLIATI

AI PUNTI VENDITA E ASSISTENZA, COMPOSTO DAI RICAMBI SOTTO ELENCATI.

SPARE PARTS KIT ADVISED

TO THE SELLING CENTERS, THIS KIT INCLUDES ALL THE SPARE PARTS SHOWN HERE UNDER.

CODICE CODE	DESCRIZIONE DESCRIPTION	Q.TÀ QTY
KR9003	GRUPPO DISTRIBUZIONE ARIA SLIDE VALVE GROUP	1
KR9050	KIT GUARNIZIONI MOTORE SUPERIORE GASKETS KIT FOR UPPER MOTOR	1
KR9056	KIT GUARNIZIONI PISTONE ø 115 GASKETS KIT FOR PISTON ø 115	1
KR9152	KIT GUARNIZIONI PESCANTE GASKETS KIT FOR SUCTION TUBE	1
KR9153	KIT GUARNIZIONI MOTORE INFERIORE GASKETS KIT FOR LOWER MOTOR	1

RAASM

FLUIDS AND LUBRICATION EQUIPMENT



Art. 115F/91 Mod. 1150F-9100



VISTA ESPLOSA - EXPLODED VIEW



POMPA FLANGIATA S. 1200
R. 9:1 - 45 l/min
FLANGED PUMP S. 1200
R. 9:1 - 45 l/min

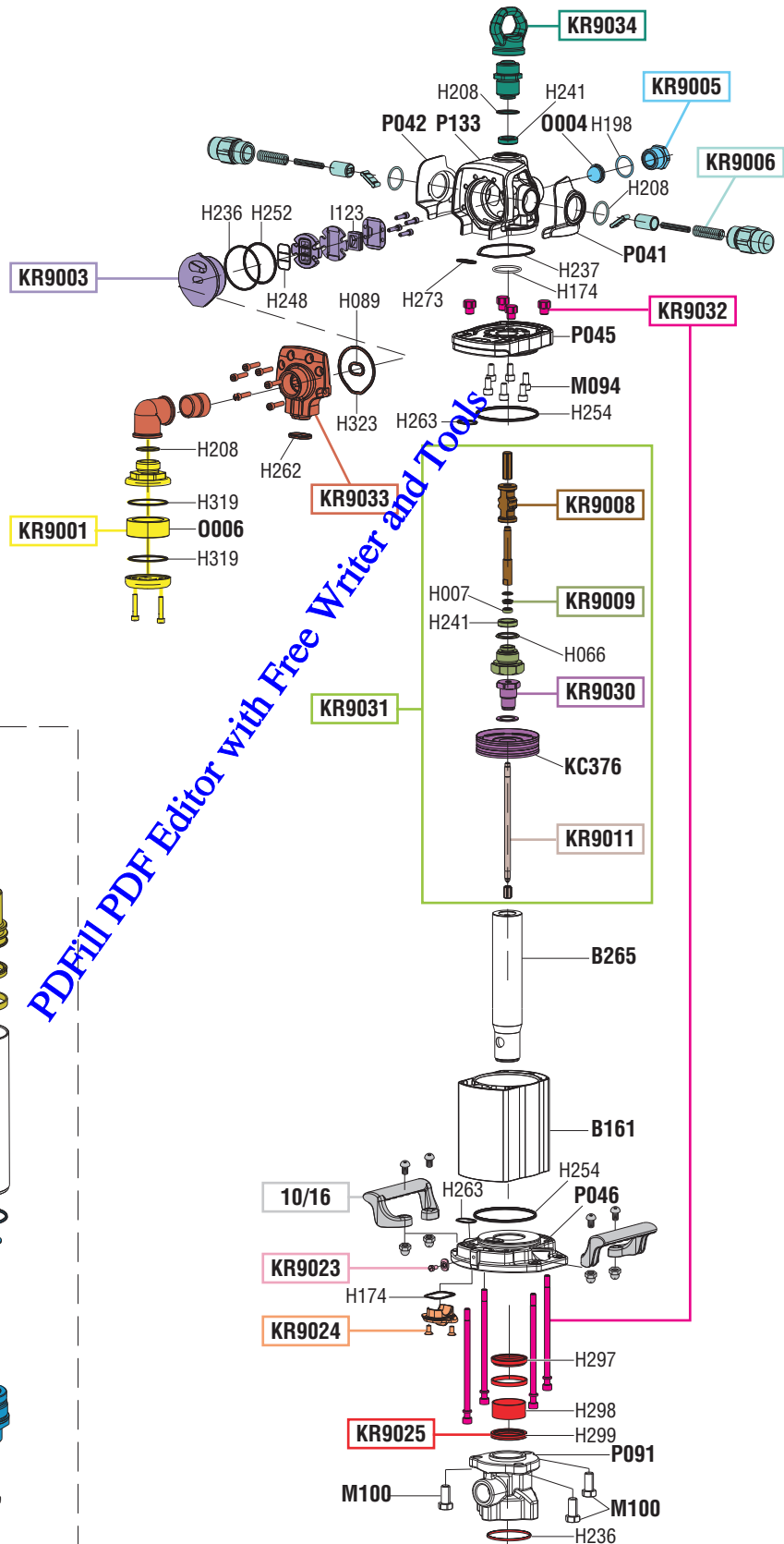

PDFfill PDF Editor with Free Writer and Tools

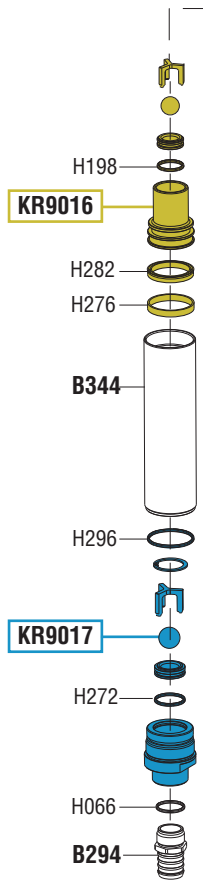

tutti i diritti riservati - all rights reserved

GUIDA RICAMBI - SPARE PARTS GUIDE

KIT RICAMBI OGNI KIT SOTTO RIPORTATO COMPRENDE I RICAMBI EVIDENZIATI CON LO STESSO COLORE E LE RELATIVE GUARNIZIONI. QUESTI RICAMBI NON SONO FORNIBILI SEPARATAMENTE TRANNE QUELLI CODIFICATI.		
SPARE PARTS KITS EACH KIT SHOWN WITH THE SAME COLOR INCLUDES ALSO THE GASKETS. THE SPARE PARTS INCLUDED IN THE KIT CAN'T BE SUPPLIED SEPARATELY EXCEPT THOSE SHOWN WITH A PROPER CODE.		
CODICE CODE	DESCRIZIONE DESCRIPTION	Q.TÀ QTY
10/16	MANIGLIE HANDLES	1
KR9001	SILENZIATORE MUFFLER	1
KR9003	GRUPPO DISTRIBUTORE D'ARIA SLIDE VALVE GROUP	1
KR9005	RIDUZIONE ENTRATA AIR INLET CONNECTION	1
KR9006	BOSSOLI INVERTITORE BUSHES	1
KR9008	GRUPPO INVERTITORE PLUNGER GROUP	1
KR9009	TAPPO SUPERIORE UPPER PLUG	1
KR9011	ASTA INVERTITORE ROD	1
KR9016	PISTONE POMPANTE PUMPING PISTON	1
KR9017	VALVOLA DI FONDO BOTTOM VALVE	1
KR9023	MESSA A TERRA GROUNDED	1
KR9024	COLLETTORE MANIFOLD	1
KR9025	GRUPPO TENUTA INFERIORE LOWER SEAL GROUP	1
KR9030	PISTONE MOTORE AIR PISTON	1
KR9031	GRUPPO DISTRIBUZIONE DISTRIBUTION GROUP	1
KR9032	PRIGIONIERI STUD BOLTS	1
KR9033	COLLETTORE DI SCARICO DISCHARGE CONNECTION	1
KR9034	GOLFARO CON BOSSOLO GUIDA STELO BUSH	1

ELENCO RICAMBI FORNIBILI SINGOLARMENTE LIST OF SPARE PARTS WHICH CAN BE SUPPLIED SEPARATELY		
CODICE CODE	DESCRIZIONE DESCRIPTION	Q.TÀ QTY
B161	CILINDRO MOTORE MOTOR CYLINDER	1
B265	STELO POMPANTE ROD	1
B294	PORTA TUBO HOSE CONNECTION	1
B344	TUBO PESCANTE SUCTION TUBE	1
KC376	PISTONE MOTORE PISTON	1
M094	VITE M8x20 SCREW M8x20	6
M100	VITE M12x25 SCREW M12x25	3
0004	FILTRO ARIA AIR FILTER	1
0006	SILENZIATORE MUFFLER	1
P041	GUANCIA SINISTRA LEFT COVER	1
P042	GUANCIA DESTRA RIGHT COVER	1
P045	PIASTRA SUPERIORE UPPER FLANGE	1
P046	PIASTRA INFERIORE LOWER FLANGE	1
P091	CORPO INFERIORE LOWER BODY	1
P133	CORPO SUPERIORE UPPER BODY	1

KIT GUARNIZIONI COMPLETI TUTTE LE GUARNIZIONI (H...) MENZIONATE NELL'ESPLOSO SONO FORNIBILI ANCHE SINGOLARMENTE		
COMPLETE GASKETS KIT ALL THE O-RING (H...) MENTIONED IN THE EXPLODED VIEW CAN BE SUPPLIED SEPARATELY		
CODICE CODE	DESCRIZIONE DESCRIPTION	Q.TÀ QTY
KR9050	KIT GUARNIZIONI MOTORE SUPERIORE GASKETS KIT FOR UPPER MOTOR	1
KR9052	KIT GUARNIZIONI PESCANTE GASKETS KIT FOR SUCTION TUBE	1
KR9056	KIT GUARNIZIONI PISTONE ø 115 GASKETS KIT FOR PISTON ø 115	1
KR9057	GRUPPO TENUTA INFERIORE LOWER SEAL GROUP	1

Art. KS9083 SET RICAMBI CONSIGLIATI AI PUNTI VENDITA E ASSISTENZA, COMPOSTO DAI RICAMBI SOTTO ELENCATI. SPARE PARTS KIT ADVISED TO THE SELLING CENTERS, THIS KIT INCLUDES ALL THE SPARE PARTS SHOWN HERE UNDER.		
CODICE CODE	DESCRIZIONE DESCRIPTION	Q.TÀ QTY
KR9003	GRUPPO DISTRIBUZIONE ARIA SLIDE VALVE GROUP	1
KR9050	KIT GUARNIZIONI MOTORE SUPERIORE GASKETS KIT FOR UPPER MOTOR	1
KR9052	KIT GUARNIZIONI PESCANTE GASKETS KIT FOR SUCTION TUBE	1
KR9056	KIT GUARNIZIONI PISTONE ø 115 GASKETS KIT FOR PISTON ø 115	1
KR9057	GRUPPO TENUTA INFERIORE LOWER SEAL GROUP	1

PDFfill PDF Editor with Free Writer and Tools

GUIDA RICAMBI - SPARE PARTS GUIDE

KIT RICAMBI OGNI KIT SOTTO RIPORTATO COMPRENDE I RICAMBI EVIDENZIATI CON LO STESSO COLORE E LE RELATIVE GUARNIZIONI. QUESTI RICAMBI NON SONO FORNIBILI SEPARATAMENTE TRANNE QUELLI CODIFICATI.		
SPARE PARTS KITS EACH KIT SHOWN WITH THE SAME COLOR INCLUDES ALSO THE GASKETS. THE SPARE PARTS INCLUDED IN THE KIT CAN'T BE SUPPLIED SEPARATELY EXCEPT THOSE SHOWN WITH A PROPER CODE.		
CODICE CODE	DESCRIZIONE DESCRIPTION	Q.TÀ QTY
10/16	MANIGLIE HANDLES	1
KR9001	SILENZIATORE MUFFLER	1
KR9003	GRUPPO DISTRIBUTORE D'ARIA SLIDE VALVE GROUP	1
KR9005	RIDUZIONE ENTRATA AIR INLET CONNECTION	1
KR9006	BOSSOLI INVERTITORE BUSHES	1
KR9008	GRUPPO INVERTITORE PLUNGER GROUP	1
KR9009	TAPPO SUPERIORE UPPER PLUG	1
KR9011	ASTA INVERTITORE ROD	1
KR9023	MESSA A TERRA GROUNDED	1
KR9024	COLLETTORE MANIFOLD	1
KR9032	PRIGIONIERI STUD BOLTS	1
KR9033	COLLETTORE DI SCARICO DISCHARGE CONNECTION	1
KR9034	GOLFARO CON BOSSOLO GUIDA STELO BUSH	1
KR9102	GRUPPO TENUTA INFERIORE LOWER SEAL GROUP	1
KR9108	GRUPPO TENUTA SUPERIORE UPPER SEAL GROUP	1
KR9109	PISTONE MOTORE AIR PISTON	1
KR9110	GRUPPO DISTRIBUZIONE DISTRIBUTION GROUP	1
KR9111	GRUPPO POMPANTE PUMPING GROUP	1
KR9112	GRUPPO PREPOMPAGGIO PUMPING GROUP	1
KR9113	FILTRO PESCANTE SHANK FILTER	1

ELENCO RICAMBI FORNIBILI SINGOLARMENTE LIST OF SPARE PARTS WHICH CAN BE SUPPLIED SEPARATELY		
CODICE CODE	DESCRIZIONE DESCRIPTION	Q.TÀ QTY
B161	CILINDRO MOTORE MOTOR CYLINDER	1
B174	ALBERO PISTONE PISTON	1
B182	TERMINALE PESCANTE SHANK END	1
B186	CILINDRO BATTUTA VALVOLA BOTTOM VALVE CYLINDER	1
B193	STELO POMPANTE PUMPING ROD	1
B194	TUBO PESCANTE SUCTION TUBE	1
B450	GIUNTO JOINT	1
B473	STELO POMPANTE PUMPING ROD	1
B771	TUBO PESCANTE SUCTION TUBE	1
KC376	PISTONE MOTORE PISTON	1
M094	VITE M8x20 SCREW M8x20	6
M100	VITE M12x25 SCREW M12x25	3
M518	SPINA ELASTICA PIN	1
0004	FILTRO ARIA AIR FILTER	1
0006	SILENZIATORE MUFFLER	1
P041	GUANCIA SINISTRA LEFT COVER	1
P042	GUANCIA DESTRA RIGHT COVER	1
P045	PIASTRA SUPERIORE UPPER FLANGE	1
P046	PIASTRA INFERIORE LOWER FLANGE	1
P048	CORPO INFERIORE LOWER BODY	1
P133	CORPO SUPERIORE UPPER BODY	1

KIT GUARNIZIONI COMPLETI TUTTE LE GUARNIZIONI (H...) MENZIONATE NELL'ESPLOSO SONO FORNIBILI ANCHE SINGOLARMENTE		
COMPLETE GASKETS KIT ALL THE O-RING (H...) MENTIONED IN THE EXPLODED VIEW CAN BE SUPPLIED SEPARATELY		
CODICE CODE	DESCRIZIONE DESCRIPTION	Q.TÀ QTY
KR9050	KIT GUARNIZIONI MOTORE SUPERIORE GASKETS KIT FOR UPPER MOTOR	1
KR9056	KIT GUARNIZIONI PISTONE ø 115 GASKETS KIT FOR PISTON ø 115	1
KR9152	KIT GUARNIZIONI MOTORE INFERIORE GASKETS KIT FOR LOWER MOTOR	1
KR9153	KIT GUARNIZIONI PESCANTE GASKETS KIT FOR SUCTION TUBE	1

SET RICAMBI CONSIGLIATI AI PUNTI VENDITA E ASSISTENZA, COMPOSTO DAI RICAMBI SOTTO ELENCATI.		
SPARE PARTS KIT ADVISED TO THE SELLING CENTERS, THIS KIT INCLUDES ALL THE SPARE PARTS SHOWN HERE UNDER.		
CODICE CODE	DESCRIZIONE DESCRIPTION	Q.TÀ QTY
KR9003	GRUPPO DISTRIBUZIONE ARIA SLIDE VALVE GROUP	1
KR9050	KIT GUARNIZIONI MOTORE SUPERIORE GASKETS KIT FOR UPPER MOTOR	1
KR9056	KIT GUARNIZIONI PISTONE ø 115 GASKETS KIT FOR PISTON ø 115	1
KR9152	KIT GUARNIZIONI PESCANTE GASKETS KIT FOR SUCTION TUBE	1
KR9153	KIT GUARNIZIONI MOTORE INFERIORE GASKETS KIT FOR LOWER MOTOR	1

PDFill PDF Editor with Free Writer and Tools



Art. 118F/401 Mod. 1150F-40160 - Art. 118FSP/401 Mod. 1150FSP-40160



VISTA ESPLOSA - EXPLODED VIEW

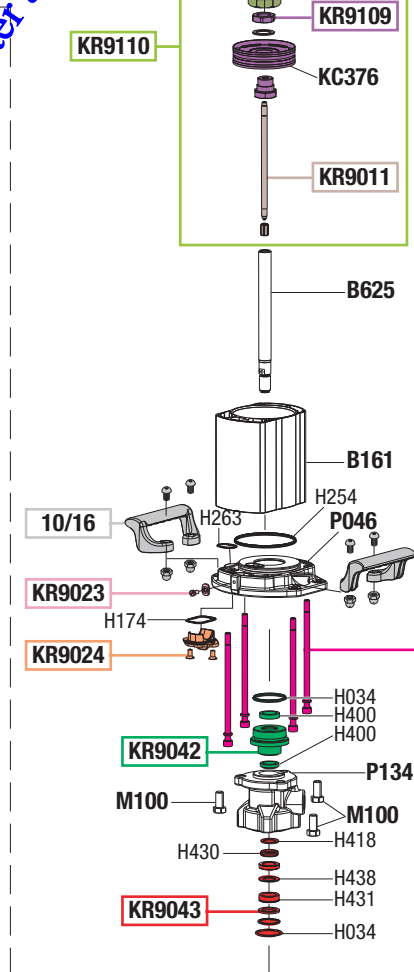
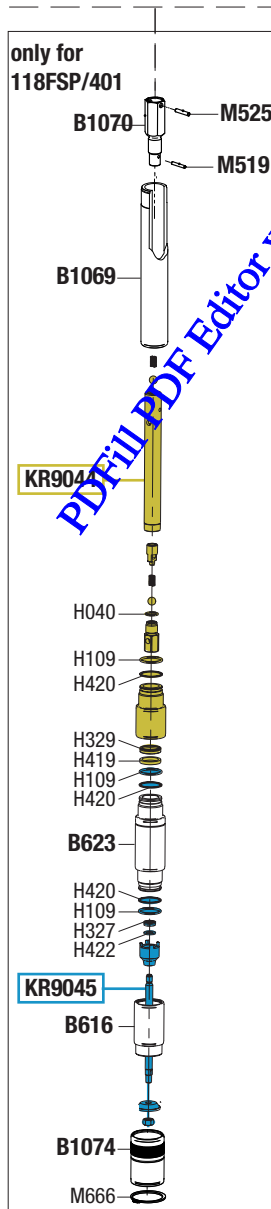
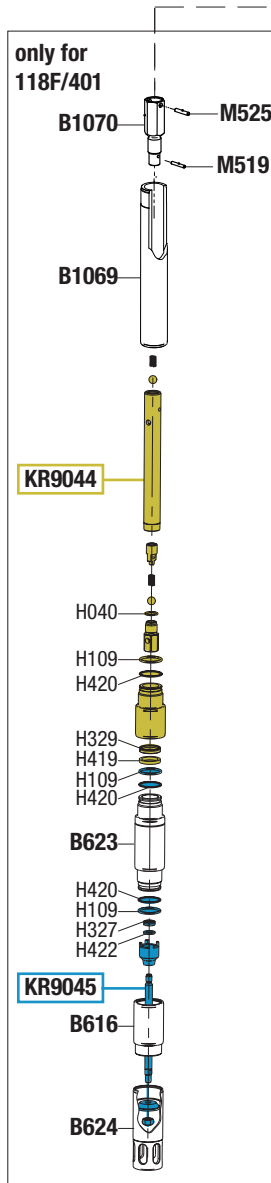
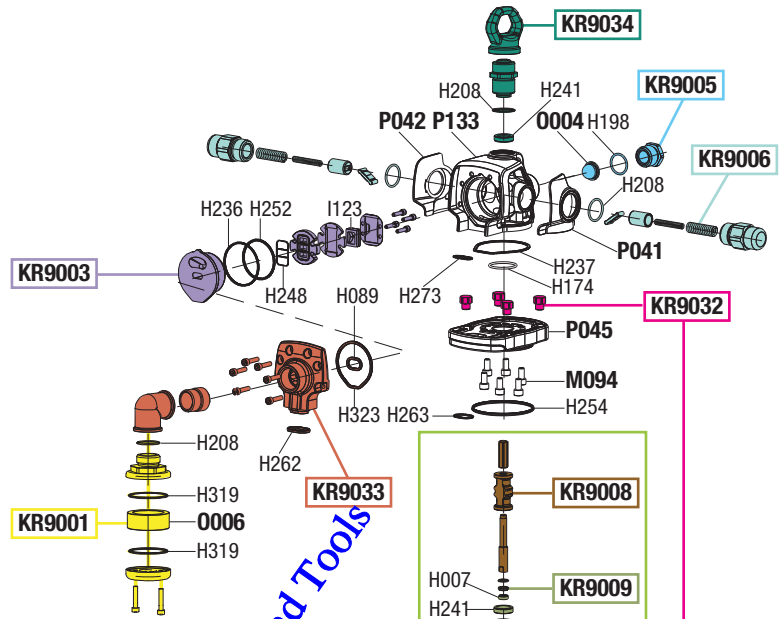
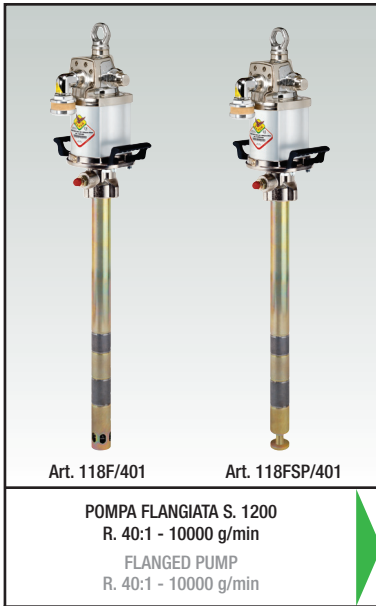

PDFFill PDF Editor with Free Writer and Tools

tutti i diritti riservati - all rights reserved

GUIDA RICAMBI - SPARE PARTS GUIDE

KIT RICAMBI

OGNI KIT SOTTO RIPORTATO COMPRENDE I RICAMBI EVIDENZIATI CON LO STESSO COLORE E LE RELATIVE GUARNIZIONI. QUESTI RICAMBI NON SONO FORNIBILI SEPARATAMENTE TRANNE QUELLI CODIFICATI.

SPARE PARTS KITS

EACH KIT SHOWN WITH THE SAME COLOR INCLUDES ALSO THE GASKETS. THE SPARE PARTS INCLUDED IN THE KIT CAN'T BE SUPPLIED SEPARATELY EXCEPT THOSE SHOWN WITH A PROPER CODE.

CODICE CODE	DESCRIZIONE DESCRIPTION	Q.TÀ QTY
10/16	MANIGLIE HANDLES	1
KR9001	SILENZIATORE MUFFLER	1
KR9003	GRUPPO DISTRIBUTORE D'ARIA SLIDE VALVE GROUP	1
KR9005	RIDUZIONE ENTRATA AIR INLET CONNECTION	1
KR9006	BOSSOLI INVERTITORE BUSHES	1
KR9008	GRUPPO INVERTITORE PLUNGER GROUP	1
KR9009	TAPPO SUPERIORE UPPER PLUG	1
KR9011	ASTA INVERTITORE ROD	1
KR9023	MESSA A TERRA GROUNDED	1
KR9024	COLLETTORE MANIFOLD	1
KR9032	PRIGIONIERI STUD BOLTS	1
KR9033	COLLETTORE DI SCARICO DISCHARGE CONNECTION	1
KR9034	GOLFARO CON BOSSOLO GUIDA STELO BUSH	1
KR9042	GRUPPO TENUTA SUPERIORE UPPER SEAL GROUP	1
KR9043	GRUPPO TENUTA INFERIORE LOWER SEAL GROUP	1
KR9044	GRUPPO POMPANTE PUMPING GROUP	1
KR9045	FILTRO PESCANTE SHANK FILTER	1
KR9109	PISTONE MOTORE AIR PISTON	1
KR9110	GRUPPO DISTRIBUZIONE DISTRIBUTION GROUP	1

ELENCO RICAMBI FORNIBILI SINGOLARMENTE

LIST OF SPARE PARTS WHICH CAN BE SUPPLIED SEPARATELY

CODICE CODE	DESCRIZIONE DESCRIPTION	Q.TÀ QTY
B161	CILINDRO MOTORE MOTOR CYLINDER	1
B616	CILINDRO BATTUTA VALVOLA BOTTOM VALVE CYLINDER	1
B623	PROLUNGA PESCANTE SUCTION TUBE EXTENSION	1
B624	TERMINALE PESCANTE SHANK END	1
B625	ALBERO PISTONE PISTON	1
B1069	TUBO PESCANTE SUCTION TUBE	1
B1070	GIUNTO JOINT	1
B1074	TERMINALE PESCANTE SHANK END	1
KC376	PISTONE MOTORE PISTON	1
M094	VITE M8x20 SCREW M8x20	6
M100	VITE M12x25 SCREW M12x25	3
M519	SPINA ELASTICA PIN	2
M525	SPINA ELASTICA PIN	1
M666	SEEGER SEEGER	1
0004	FILTRO ARIA AIR FILTER	1
0006	SILENZIATORE MUFFLER	1
P041	GUANCIA SINISTRA LEFT COVER	1
P042	GUANCIA DESTRA RIGHT COVER	1
P045	PIASTRA SUPERIORE UPPER FLANGE	1
P046	PIASTRA INFERIORE LOWER FLANGE	1
P133	CORPO SUPERIORE UPPER BODY	1
P134	CORPO INFERIORE LOWER BODY	1

KIT GUARNIZIONI COMPLETI

TUTTE LE GUARNIZIONI (H...) MENZIONATE NELL'ESPLOSO SONO FORNIBILI ANCHE SINGOLARMENTE

COMPLETE GASKETS KIT

ALL THE O-RING (H...) MENTIONED IN THE EXPLODED VIEW CAN BE SUPPLIED SEPARATELY

CODICE CODE	DESCRIZIONE DESCRIPTION	Q.TÀ QTY
KR9050	KIT GUARNIZIONI MOTORE SUPERIORE GASKETS KIT FOR UPPER MOTOR	1
KR9056	KIT GUARNIZIONI PISTONE ø 90 GASKETS KIT FOR PISTON ø 90	1
KR9065	KIT GUARNIZIONI MOTORE INFERIORE GASKETS KIT FOR LOWER MOTOR	1
KR9066	KIT GUARNIZIONI PESCANTE GASKETS KIT FOR SUCTION TUBE	1

Art.
KS9189

SET RICAMBI CONSIGLIATI

AI PUNTI VENDITA E ASSISTENZA, COMPOSTO DAI RICAMBI SOTTO ELENCATI.

SPARE PARTS KIT ADVISED

TO THE SELLING CENTERS, THIS KIT INCLUDES ALL THE SPARE PARTS SHOWN HERE UNDER.

CODICE CODE	DESCRIZIONE DESCRIPTION	Q.TÀ QTY
KR9003	GRUPPO DISTRIBUZIONE ARIA SLIDE VALVE GROUP	1
KR9050	KIT GUARNIZIONI MOTORE SUPERIORE GASKETS KIT FOR UPPER MOTOR	1
KR9056	KIT GUARNIZIONI PISTONE ø 90 GASKETS KIT FOR PISTON ø 90	1
KR9065	KIT GUARNIZIONI PESCANTE GASKETS KIT FOR SUCTION TUBE	1
KR9066	KIT GUARNIZIONI MOTORE INFERIORE GASKETS KIT FOR LOWER MOTOR	1

RAASM

FLUIDS AND LUBRICATION EQUIPMENT



Art. 120D/91 Mod. 1200D-9100



VISTA ESPLOSA - EXPLODED VIEW



POMPA DISSOCIATA AISI 304 S.1200
R. 9:1 - 42 l/min
DIVORCED PUMP S. 1200
R 9:1 - 42 l/min

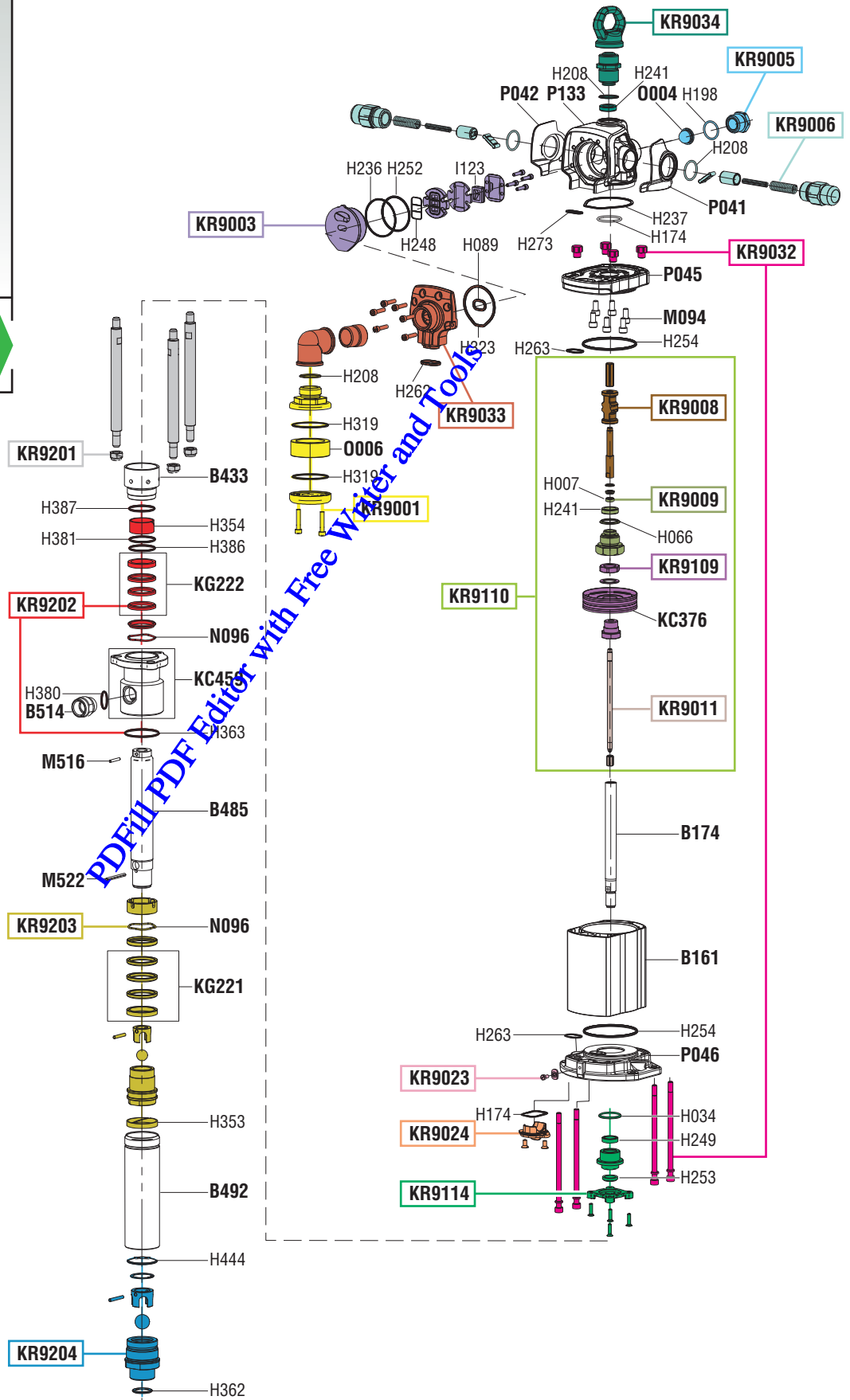

PDFill PDF Editor with Free Water and Tools

GUIDA RICAMBI - SPARE PARTS GUIDE

KIT RICAMBI
OGNI KIT SOTTO RIPORTATO COMPRENDE I RICAMBI EVIDENZIATI CON LO STESSO COLORE E LE RELATIVE GUARNIZIONI. QUESTI RICAMBI NON SONO FORNIBILI SEPARATAMENTE TRANNE QUELLI CODIFICATI.

SPARE PARTS KITS

EACH KIT SHOWN WITH THE SAME COLOR INCLUDES ALSO THE GASKETS. THE SPARE PARTS INCLUDED IN THE KIT CAN'T BE SUPPLIED SEPARATELY EXCEPT THOSE SHOWN WITH A PROPER CODE.

CODICE CODE	DESCRIZIONE DESCRIPTION	Q.TÀ QTY
KR9001	SILENZIATORE MUFFLER	1
KR9003	GRUPPO DISTRIBUTORE D'ARIA SLIDE VALVE GROUP	1
KR9005	RIDUZIONE ENTRATA AIR INLET CONNECTION	1
KR9006	BOSSOLI INVERTITORE BUSHES	1
KR9008	GRUPPO INVERTITORE PLUNGER GROUP	1
KR9009	TAPPO SUPERIORE UPPER PLUG	1
KR9011	ASTA INVERTITORE ROD	1
KR9023	MESSA A TERRA GROUNDED	1
KR9024	COLLETTORE MANIFOLD	1
KR9032	PRIGIONIERI STUD BOLTS	1
KR9033	COLLETTORE DI SCARICO DISCHARGE CONNECTION	1
KR9034	BOSSOLO GUIDA STELO BUSH	1
KR9109	PISTONE MOTORE AIR PISTON	1
KR9110	GRUPPO DISTRIBUZIONE DISTRIBUTION GROUP	1
KR9114	GRUPPO TENUTA INFERIORE LOWER SEAL GROUP	1
KR9201	PRIGIONIERI STUD BOLTS	1
KR9202	GRUPPO TENUTA INFERIORE LOWER SEAL GROUP	1
KR9203	PISTONE POMPANTE PUMPING PISTON	1
KR9204	VALVOLA DI FONDO BOTTOM VALVE	1

ELENCO RICAMBI FORNIBILI SINGOLARMENTE
LIST OF SPARE PARTS WHICH CAN BE SUPPLIED SEPARATELY

CODICE CODE	DESCRIZIONE DESCRIPTION	Q.TÀ QTY
B161	CILINDRO MOTORE MOTOR CYLINDER	1
B174	ALBERO PISTONE PISTON	1
B433	GHIERA REGOLAZIONE REGULATING RING NUT	1
B485	STELO PESCANTE PUMPING ROD	1
B492	TUBO PESCANTE SUCTION TUBE	1
B514	NIPPES USCITA OUTLET CONNECTION	1
KC376	PISTONE MOTORE PISTON	1
KC459	CORPO INFERIORE LOWER BODY	1
KG221	GUARNIZIONI GASKETS	1
KG222	GUARNIZIONI GASKETS	1
M094	VITE M8x20 SCREW M8x20	6
M516	SPINA ELASTICA PIN	1
M522	SPINA ELASTICA PIN	2
N096	MOLLA SPRING	2
0004	FILTRO ARIA AIR FILTER	1
0006	SILENZIATORE MUFFLER	1
P041	GUANCIA SINISTRA LEFT COVER	1
P042	GUANCIA DESTRA RIGHT COVER	1
P045	PIASTRA SUPERIORE UPPER FLANGE	1
P046	PIASTRA INFERIORE LOWER FLANGE	1
P133	CORPO SUPERIORE UPPER BODY	1

KIT GUARNIZIONI COMPLETI

TUTTE LE GUARNIZIONI (H...) MENZIONATE NELL'ESPLOSO SONO FORNIBILI ANCHE SINGOLARMENTE

COMPLETE GASKETS KIT

ALL THE O-RING (H...) MENTIONED IN THE EXPLODED VIEW CAN BE SUPPLIED SEPARATELY

CODICE CODE	DESCRIZIONE DESCRIPTION	Q.TÀ QTY
KR9050	KIT GUARNIZIONI MOTORE SUPERIORE GASKETS KIT FOR UPPER MOTOR	1
KR9056	KIT GUARNIZIONI PISTONE ø 115 GASKETS KIT FOR PISTON ø 115	1
KR9250	KIT GUARNIZIONI MOTORE INFERIORE GASKETS KIT FOR LOWER MOTOR	1
KR9251	KIT GUARNIZIONI PESCANTE GASKETS KIT FOR SUCTION TUBE	1

Art.
KS9281

SET RICAMBI CONSIGLIATI

AI PUNTI VENDITA E ASSISTENZA, COMPOSTO DAI RICAMBI SOTTO ELENCATI.

SPARE PARTS KIT ADVISED

TO THE SELLING CENTERS. THIS KIT INCLUDES ALL THE SPARE PARTS SHOWN HERE UNDER.

CODICE CODE	DESCRIZIONE DESCRIPTION	Q.TÀ QTY
KR9003	GRUPPO DISTRIBUZIONE ARIA SLIDE VALVE GROUP	1
KR9050	KIT GUARNIZIONI MOTORE SUPERIORE GASKETS KIT FOR UPPER MOTOR	1
KR9056	KIT GUARNIZIONI PISTONE ø 115 GASKETS KIT FOR PISTON ø 115	1
KR9250	KIT GUARNIZIONI MOTORE INFERIORE GASKETS KIT FOR LOWER MOTOR	1
KR9251	KIT GUARNIZIONI PESCANTE GASKETS KIT FOR SUCTION TUBE	1

RAASM

FLUIDS AND LUBRICATION EQUIPMENT



Art. 150D/41 Mod. 1500D-4100



VISTA ESPLOSA - EXPLODED VIEW

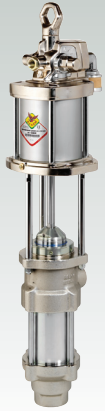

POMPA DISSOCIATA S.1500
R. 4:1 - 110 l/min
DIVORCED PUMP S.1500
R. 4:1 - 110 l/min

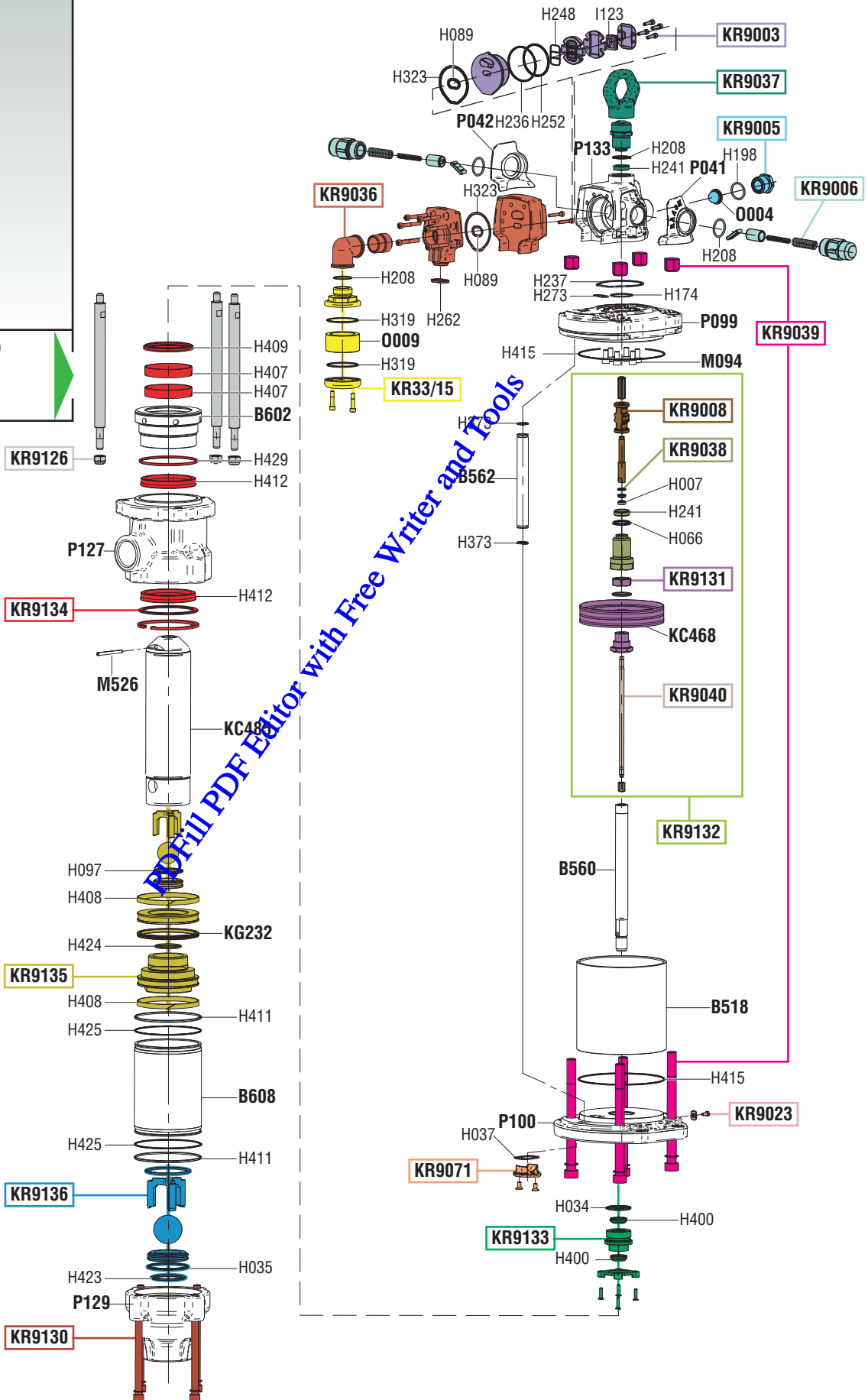

PDF Fill PDF Editor with Free Writer and Tools

tutti i diritti riservati - all rights reserved

GUIDA RICAMBI - SPARE PARTS GUIDE

KIT RICAMBI OGNI KIT SOTTO RIPORTATO COMPRENDE I RICAMBI EVIDENZIATI CON LO STESSO COLORE E LE RELATIVE GUARNIZIONI. QUESTI RICAMBI NON SONO FORNIBILI SEPARATAMENTE TRANNE QUELLI CODIFICATI.		
SPARE PARTS KITS EACH KIT SHOWN WITH THE SAME COLOR INCLUDES ALSO THE GASKETS. THE SPARE PARTS INCLUDED IN THE KIT CAN'T BE SUPPLIED SEPARATELY EXCEPT THOSE SHOWN WITH A PROPER CODE.		
CODICE CODE	DESCRIZIONE DESCRIPTION	Q.TÀ QTY
KR33/15	SILENZIATORE MUFFLER	1
KR9003	GRUPPO DISTRIBUTORE D'ARIA SLIDE VALVE GROUP	1
KR9005	RIDUZIONE ENTRATA AIR INLET CONNECTION	1
KR9006	BOSSOLI INVERTITORE BUSHES	1
KR9008	GRUPPO INVERTITORE PLUNGER GROUP	1
KR9023	MESSA A TERRA GROUNDED	1
KR9036	COLLETTORE DI SCARICO DISCHARGE CONNECTION	1
KR9037	BOSSOLO GUIDA STELO BUSH	1
KR9038	TAPPO SUPERIORE UPPER PLUG	1
KR9039	PRIGIONIERI STUD BOLTS	1
KR9040	ASTA INVERTITORE ROD	1
KR9071	COLLETTORE MANIFOLD	1
KR9126	PRIGIONIERI STUD BOLTS	1
KR9130	PRIGIONIERI STUD BOLTS	1
KR9131	PISTONE MOTORE AIR PISTON	1
KR9132	GRUPPO DISTRIBUZIONE DISTRIBUTION GROUP	1
KR9133	GRUPPO TENUTA SUPERIORE UPPER SEAL GROUP	1
KR9134	GRUPPO TENUTA INFERIORE LOWER SEAL GROUP	1
KR9135	GRUPPO POMPANTE PUMPING GROUP	1
KR9136	VALVOLA DI FONDO BOTTOM VALVE	1

ELENCO RICAMBI FORNIBILI SINGOLARMENTE LIST OF SPARE PARTS WHICH CAN BE SUPPLIED SEPARATELY		
CODICE CODE	DESCRIZIONE DESCRIPTION	Q.TÀ QTY
B518	CILINDRO MOTORE MOTOR CYLINDER	1
B560	ALBERO PISTONE PISTON	1
B562	TUBETTO RICIRCOLO ARIA AIR RECOVERY TUBE	1
B602	GHIERA CHIUSURA LOCKUP RING NUT	1
B608	TUBO PESCANTE SUCTION TUBE	1
KC468	PISTONE MOTORE PISTON	1
KC485	STELO POMPANTE PUMPING ROD	1
KG232	GUARNIZIONE PISTONE PISTON GASKET	1
M094	VITE M8x20 SCREW M8x20	6
M526	SPINA ELASTICA PIN	1
O004	FILTRO ARIA AIR FILTER	1
O009	SILENZIATORE MUFFLER	1
P041	GUANCIA SINISTRA LEFT COVER	1
P042	GUANCIA DESTRA RIGHT COVER	1
P099	PIASTRA SUPERIORE UPPER FLANGE	1
P100	PIASTRA INFERIORE LOWER FLANGE	1
P127	CORPO INFERIORE LOWER BODY	1
P129	CORPO INFERIORE PESCANTE LOWER SUCTION BODY	1
P133	CORPO SUPERIORE UPPER BODY	1

KIT GUARNIZIONI COMPLETI TUTTE LE GUARNIZIONI (H...) MENZIONATE NELL'ESPLOSO SONO FORNIBILI ANCHE SINGOLARMENTE		
COMPLETE GASKETS KIT ALL THE O-RING (H...) MENTIONED IN THE EXPLODED VIEW CAN BE SUPPLIED SEPARATELY		
CODICE CODE	DESCRIZIONE DESCRIPTION	Q.TÀ QTY
KR9061	KIT GUARNIZIONI MOTORE SUPERIORE GASKETS KIT FOR UPPER MOTOR	1
KR9062	KIT GUARNIZIONI PISTONE ø 150 GASKETS KIT FOR PISTON ø 150	1
KR9162	KIT GUARNIZIONI MOTORE INFERIORE GASKETS KIT FOR LOWER MOTOR	1
KR9163	KIT GUARNIZIONI PESCANTE GASKETS KIT FOR SUCTION TUBE	1

Art. KS9190	SET RICAMBI CONSIGLIATI AI PUNTI VENDITA E ASSISTENZA, COMPOSTO DAI RICAMBI SOTTO ELENCATI. SPARE PARTS KIT ADVISED TO THE SELLING CENTERS, THIS KIT INCLUDES ALL THE SPARE PARTS SHOWN HERE UNDER.	
CODICE CODE	DESCRIZIONE DESCRIPTION	Q.TÀ QTY
KR9003	GRUPPO DISTRIBUZIONE ARIA SLIDE VALVE GROUP	1
KR9061	KIT GUARNIZIONI MOTORE SUPERIORE GASKETS KIT FOR UPPER MOTOR	1
KR9062	KIT GUARNIZIONI PISTONE ø 150 GASKETS KIT FOR PISTON ø 150	1
KR9162	KIT GUARNIZIONI MOTORE INFERIORE GASKETS KIT FOR LOWER MOTOR	1
KR9163	KIT GUARNIZIONI PESCANTE GASKETS KIT FOR SUCTION TUBE	1

PDFfill PDF Editor with Free Writer and Tools

GUIDA RICAMBI - SPARE PARTS GUIDE

KIT RICAMBI OGNI KIT SOTTO RIPORTATO COMPRENDE I RICAMBI EVIDENZIATI CON LO STESSO COLORE E LE RELATIVE GUARNIZIONI. QUESTI RICAMBI NON SONO FORNIBILI SEPARATAMENTE TRANNE QUELLI CODIFICATI.		
SPARE PARTS KITS EACH KIT SHOWN WITH THE SAME COLOR INCLUDES ALSO THE GASKETS. THE SPARE PARTS INCLUDED IN THE KIT CAN'T BE SUPPLIED SEPARATELY EXCEPT THOSE SHOWN WITH A PROPER CODE.		
CODICE CODE	DESCRIZIONE DESCRIPTION	Q.TÀ QTY
KR33/15	SILENZIATORE MUFFLER	1
KR9003	GRUPPO DISTRIBUTORE D'ARIA SLIDE VALVE GROUP	1
KR9005	RIDUZIONE ENTRATA AIR INLET CONNECTION	1
KR9006	BOSSOLI INVERTITORE BUSHES	1
KR9008	GRUPPO INVERTITORE PLUNGER GROUP	1
KR9023	MESSA A TERRA GROUNDED	1
KR9036	COLLETTORE DI SCARICO DISCHARGE CONNECTION	1
KR9037	BOSSOLO GUIDA STELO BUSH	1
KR9038	TAPPO SUPERIORE UPPER PLUG	1
KR9039	PRIGIONIERI STUD BOLTS	1
KR9040	ASTA INVERTITORE ROD	1
KR9071	COLLETTORE MANIFOLD	1
KR9126	PRIGIONIERI STUD BOLTS	1
KR9127	GRUPPO TENUTA INFERIORE LOWER SEAL GROUP	1
KR9128	GRUPPO POMPANTE PUMPING GROUP	1
KR9129	VALVOLA DI FONDO BOTTOM VALVE	1
KR9130	PRIGIONIERI STUD BOLTS	1
KR9131	PISTONE MOTORE AIR PISTON	1
KR9132	GRUPPO DISTRIBUZIONE DISTRIBUTION GROUP	1
KR9133	GRUPPO TENUTA SUPERIORE UPPER SEAL GROUP	1

ELENCO RICAMBI FORNIBILI SINGOLARMENTE LIST OF SPARE PARTS WHICH CAN BE SUPPLIED SEPARATELY		
CODICE CODE	DESCRIZIONE DESCRIPTION	Q.TÀ QTY
B518	CILINDRO MOTORE MOTOR CYLINDER	1
B528	GHIERA CHIUSURA LOCKUP RING NUT	1
B529	TUBO PESCANTE SUCTION TUBE	1
B560	ALBERO PISTONE PISTON	1
B562	TUBETTO RICIRCOLO ARIA AIR RECOVERY TUBE	1
KC468	PISTONE MOTORE PISTON	1
KC484	STELO POMPANTE PUMPING ROD	1
KG230	GUARNIZIONE PISTONE PISTON GASKET	1
M094	VITE M8x20 SCREW M8x20	6
M522	SPINA ELASTICA PIN	1
O004	FILTRO ARIA AIR FILTER	1
O009	SILENZIATORE MUFFLER	1
P041	GUANCIA SINISTRA LEFT COVER	1
P042	GUANCIA DESTRA RIGHT COVER	1
P099	PIASTRA SUPERIORE UPPER FLANGE	1
P100	PIASTRA INFERIORE LOWER FLANGE	1
P126	CORPO INFERIORE LOWER BODY	1
P128	CORPO INFERIORE PESCANTE LOWER SUCTION BODY	1
P133	CORPO SUPERIORE UPPER BODY	1

KIT GUARNIZIONI COMPLETI TUTTE LE GUARNIZIONI (H...) MENZIONATE NELL'ESPLOSO SONO FORNIBILI ANCHE SINGOLARMENTE		
COMPLETE GASKETS KIT ALL THE O-RING (H...) MENTIONED IN THE EXPLODED VIEW CAN BE SUPPLIED SEPARATELY		
CODICE CODE	DESCRIZIONE DESCRIPTION	Q.TÀ QTY
KR9061	KIT GUARNIZIONI MOTORE SUPERIORE GASKETS KIT FOR UPPER MOTOR	1
KR9062	KIT GUARNIZIONI PISTONE ø 150 GASKETS KIT FOR PISTON ø 150	1
KR9160	KIT GUARNIZIONI MOTORE INFERIORE GASKETS KIT FOR LOWER MOTOR	1
KR9161	KIT GUARNIZIONI PESCANTE GASKETS KIT FOR SUCTION TUBE	1

PDFfill PDF Editor with Free Writer and Tools

SET RICAMBI CONSIGLIATI AI PUNTI VENDITA E ASSISTENZA, COMPOSTO DAI RICAMBI SOTTO ELENCATI.		
SPARE PARTS KIT ADVISED TO THE SELLING CENTERS, THIS KIT INCLUDES ALL THE SPARE PARTS SHOWN HERE UNDER.		
CODICE CODE	DESCRIZIONE DESCRIPTION	Q.TÀ QTY
KR9003	GRUPPO DISTRIBUZIONE ARIA SLIDE VALVE GROUP	1
KR9061	KIT GUARNIZIONI MOTORE SUPERIORE GASKETS KIT FOR UPPER MOTOR	1
KR9062	KIT GUARNIZIONI PISTONE ø 150 GASKETS KIT FOR PISTON ø 150	1
KR9160	KIT GUARNIZIONI MOTORE INFERIORE GASKETS KIT FOR LOWER MOTOR	1
KR9161	KIT GUARNIZIONI PESCANTE GASKETS KIT FOR SUCTION TUBE	1



Art. 150DV/61 Mod. 1500DV-6100



VISTA ESPLOSA - EXPLODED VIEW



POMPA DISSOCIATA S.1500
R. 6:1 - 80 l/min
DIVORCED PUMP S.1500
R. 6:1 - 80 l/min

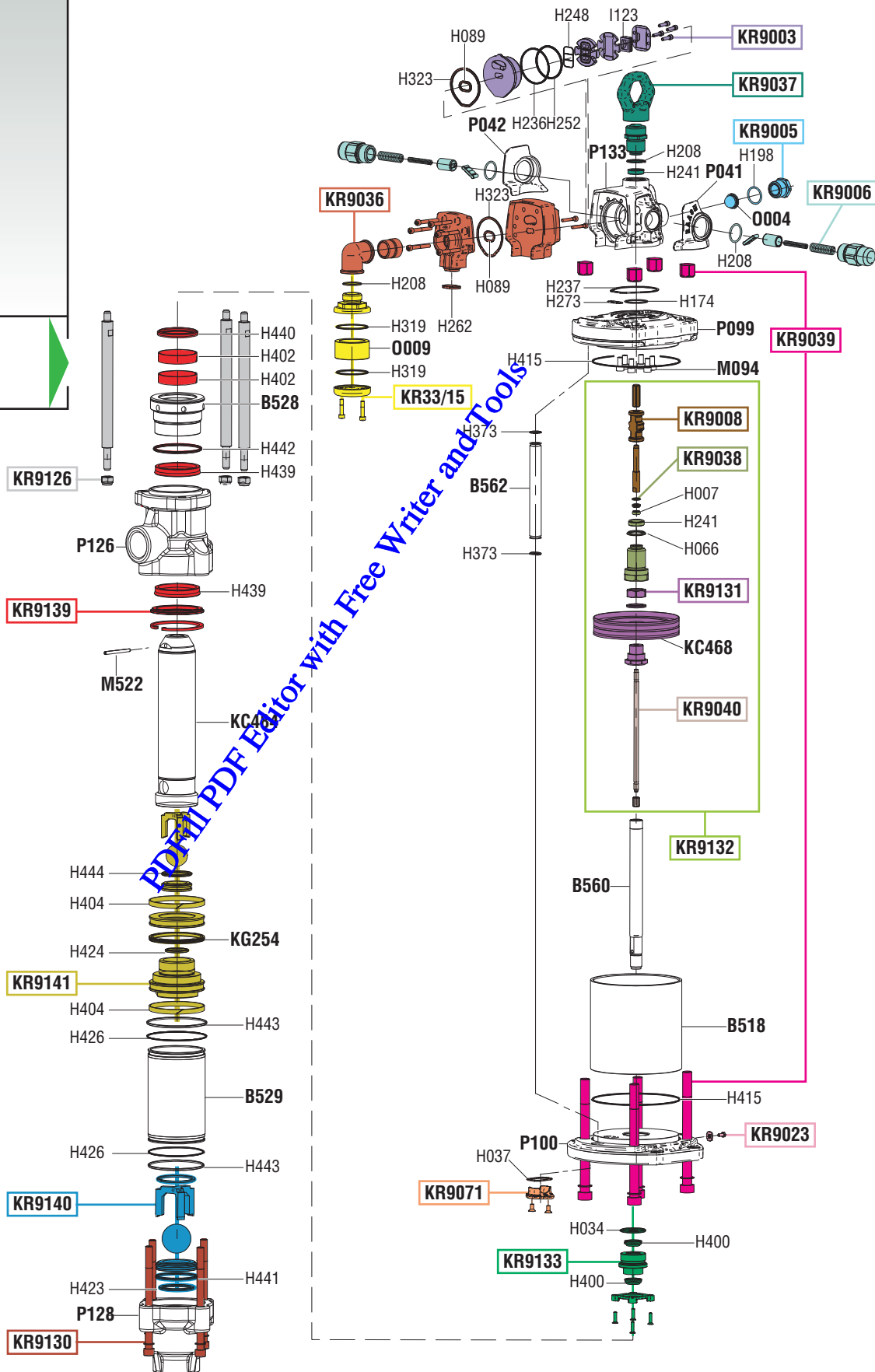

PDF FILE Editor with Free Writer and Tools

tutti i diritti riservati - all rights reserved

GUIDA RICAMBI - SPARE PARTS GUIDE

KIT RICAMBI

OGNI KIT SOTTO RIPORTATO COMPRENDE I RICAMBI EVIDENZIATI CON LO STESSO COLORE E LE RELATIVE GUARNIZIONI. QUESTI RICAMBI NON SONO FORNIBILI SEPARATAMENTE TRANNE QUELLI CODIFICATI.

SPARE PARTS KITS

EACH KIT SHOWN WITH THE SAME COLOR INCLUDES ALSO THE GASKETS. THE SPARE PARTS INCLUDED IN THE KIT CAN'T BE SUPPLIED SEPARATELY EXCEPT THOSE SHOWN WITH A PROPER CODE.

CODICE CODE	DESCRIZIONE DESCRIPTION	Q.TÀ QTY
KR33/15	SILENZIATORE MUFFLER	1
KR9003	GRUPPO DISTRIBUTORE D'ARIA SLIDE VALVE GROUP	1
KR9005	RIDUZIONE ENTRATA AIR INLET CONNECTION	1
KR9006	BOSSOLI INVERTITORE BUSHES	1
KR9008	GRUPPO INVERTITORE PLUNGER GROUP	1
KR9023	MESSA A TERRA GROUNDED	1
KR9036	COLLETTORE DI SCARICO DISCHARGE CONNECTION	1
KR9037	BOSSOLO GUIDA STELO BUSH	1
KR9038	TAPPO SUPERIORE UPPER PLUG	1
KR9039	PRIGIONIERI STUD BOLTS	1
KR9040	ASTA INVERTITORE ROD	1
KR9071	COLLETTORE MANIFOLD	1
KR9126	PRIGIONIERI STUD BOLTS	1
KR9130	PRIGIONIERI STUD BOLTS	1
KR9131	PISTONE MOTORE AIR PISTON	1
KR9132	GRUPPO DISTRIBUZIONE DISTRIBUTION GROUP	1
KR9133	GRUPPO TENUTA SUPERIORE UPPER SEAL GROUP	1
KR9139	GRUPPO TENUTA INFERIORE LOWER SEAL GROUP	1
KR9140	VALVOLA DI FONDO BOTTOM VALVE	1
KR9141	PISTONE POMPANTE PUMPING PISTON	1

ELENCO RICAMBI FORNIBILI SINGOLARMENTE
LIST OF SPARE PARTS WHICH CAN BE SUPPLIED SEPARATELY

CODICE CODE	DESCRIZIONE DESCRIPTION	Q.TÀ QTY
B518	CILINDRO MOTORE MOTOR CYLINDER	1
B528	GHIERA CHIUSURA LOCKUP RING NUT	1
B529	TUBO PESCANTE SUCTION TUBE	1
B560	ALBERO PISTONE PISTON	1
B562	TUBETTO RICIRCOLO ARIA AIR RECOVERY TUBE	1
KC468	PISTONE MOTORE PISTON	1
KC484	STELO POMPANTE PUMPING ROD	1
KG254	GUARNIZIONE PISTONE PISTON GASKET	1
M094	VITE M8x20 SCREW M8x20	6
M522	SPINA ELASTICA PIN	1
O004	FILTRO ARIA AIR FILTER	1
O009	SILENZIATORE MUFFLER	1
P041	GUANCIA SINISTRA LEFT COVER	1
P042	GUANCIA DESTRA RIGHT COVER	1
P099	PIASTRA SUPERIORE UPPER FLANGE	1
P100	PIASTRA INFERIORE LOWER FLANGE	1
P126	CORPO INFERIORE LOWER BODY	1
P128	CORPO INFERIORE PESCANTE LOWER SUCTION BODY	1
P133	CORPO SUPERIORE UPPER BODY	1

KIT GUARNIZIONI COMPLETI

TUTTE LE GUARNIZIONI (H...) MENZIONATE NELL'ESPLOSO SONO FORNIBILI ANCHE SINGOLARMENTE

COMPLETE GASKETS KIT

ALL THE O-RING (H...) MENTIONED IN THE EXPLODED VIEW CAN BE SUPPLIED SEPARATELY

CODICE CODE	DESCRIZIONE DESCRIPTION	Q.TÀ QTY
KR9061	KIT GUARNIZIONI MOTORE SUPERIORE GASKETS KIT FOR UPPER MOTOR	1
KR9062	KIT GUARNIZIONI PISTONE ø 150 GASKETS KIT FOR PISTON ø 150	1
KR9164	KIT GUARNIZIONI MOTORE INFERIORE GASKETS KIT FOR LOWER MOTOR	1
KR9165	KIT GUARNIZIONI PESCANTE GASKETS KIT FOR SUCTION TUBE	1

Art.
KS9093

SET RICAMBI CONSIGLIATI

AI PUNTI VENDITA E ASSISTENZA, COMPOSTO DAI RICAMBI SOTTO ELENCATI.

SPARE PARTS KIT ADVISED

TO THE SELLING CENTERS, THIS KIT INCLUDES ALL THE SPARE PARTS SHOWN HERE UNDER.

CODICE CODE	DESCRIZIONE DESCRIPTION	Q.TÀ QTY
KR9003	GRUPPO DISTRIBUZIONE ARIA SLIDE VALVE GROUP	1
KR9061	KIT GUARNIZIONI MOTORE SUPERIORE GASKETS KIT FOR UPPER MOTOR	1
KR9062	KIT GUARNIZIONI PISTONE ø 150 GASKETS KIT FOR PISTON ø 150	1
KR9164	KIT GUARNIZIONI MOTORE INFERIORE GASKETS KIT FOR LOWER MOTOR	1
KR9165	KIT GUARNIZIONI PESCANTE GASKETS KIT FOR SUCTION TUBE	1

PDFfill PDF Editor with Free Writer and Tools



Art. 150F/701 Mod. 1500F-70174 - Art. 151F/701 Mod. 1500F-70194
Art. 152F/701 Mod. 1500F-70184



VISTA ESPLOSA - EXPLODED VIEW

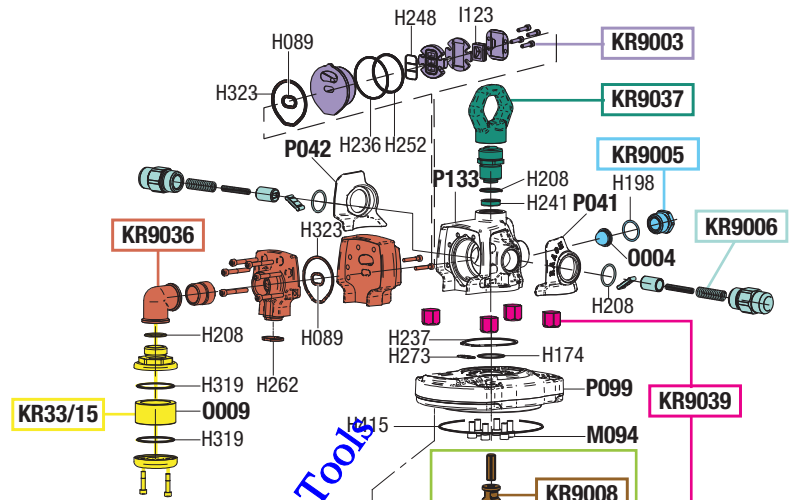
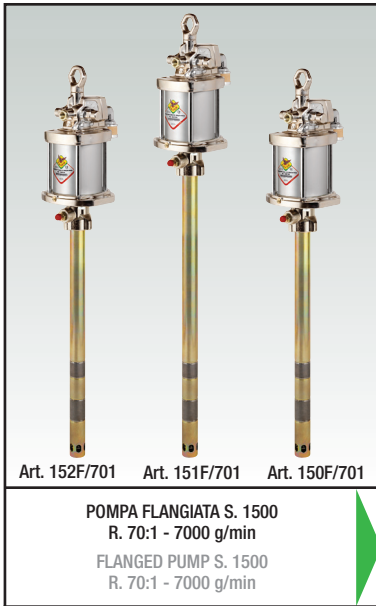

only for 152F/701

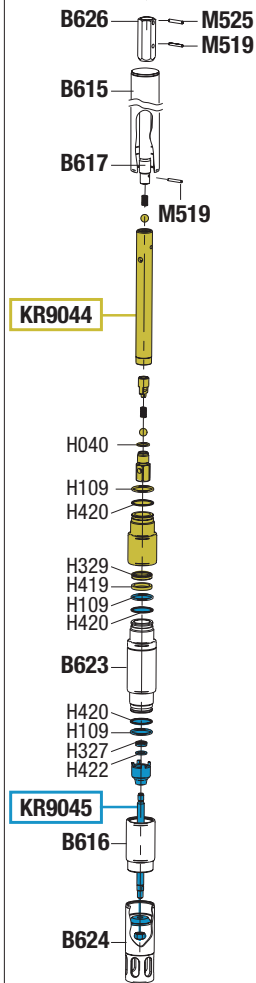

only for 151F/701

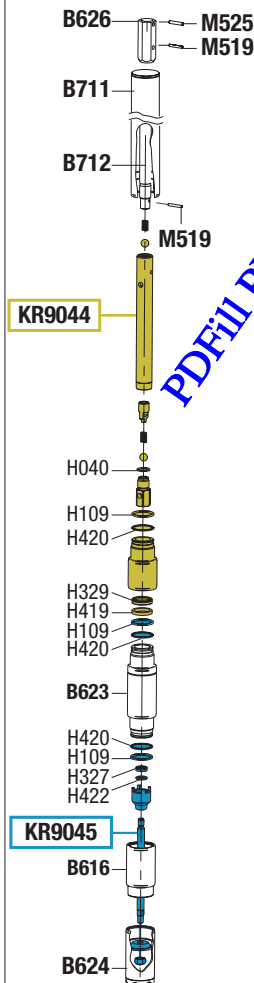

only for 150F/701

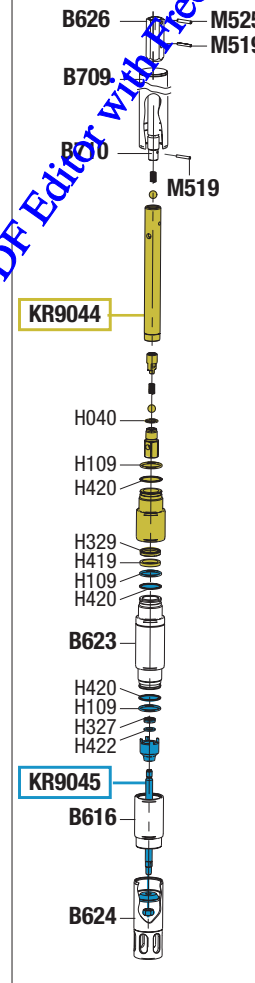

PDFfill PDF Editor with Free Writer and Tools

GUIDA RICAMBI - SPARE PARTS GUIDE

KIT RICAMBI

OGNI KIT SOTTO RIPORTATO COMPRENDE I RICAMBI EVIDENZIATI CON LO STESSO COLORE E LE RELATIVE GUARNIZIONI. QUESTI RICAMBI NON SONO FORNIBILI SEPARATAMENTE TRANNE QUELLI CODIFICATI.

SPARE PARTS KITS

EACH KIT SHOWN WITH THE SAME COLOR INCLUDES ALSO THE GASKETS. THE SPARE PARTS INCLUDED IN THE KIT CAN'T BE SUPPLIED SEPARATELY EXCEPT THOSE SHOWN WITH A PROPER CODE.

CODICE CODE	DESCRIZIONE DESCRIPTION	Q.TÀ QTY
KR33/15	SILENZIATORE MUFFLER	1
KR9003	GRUPPO DISTRIBUTORE D'ARIA SLIDE VALVE GROUP	1
KR9005	RIDUZIONE ENTRATA AIR INLET CONNECTION	1
KR9006	BOSSOLI INVERTITORE BUSHES	1
KR9008	GRUPPO INVERTITORE PLUNGER GROUP	1
KR9023	MESSA A TERRA GROUNDED	1
KR9036	COLLETTORE DI SCARICO DISCHARGE CONNECTION	1
KR9037	BOSSOLO GUIDA STELO BUSH	1
KR9038	TAPPO SUPERIORE UPPER PLUG	1
KR9039	PRIGIONIERI STUD BOLTS	1
KR9040	ASTA INVERTITORE ROD	1
KR9043	GRUPPO TENUTA INFERIORE LOWER SEAL GROUP	1
KR9044	GRUPPO POMPANTE PUMPING GROUP	1
KR9045	FILTRO PESCANTE SHANK FILTER	1
KR9046	GRUPPO TENUTA SUPERIORE UPPER SEAL GROUP	1
KR9071	COLLETTORE MANIFOLD	1
KR9131	PISTONE MOTORE AIR PISTON	1
KR9132	GRUPPO DISTRIBUZIONE DISTRIBUTION GROUP	1

ELENCO RICAMBI FORNIBILI SINGOLARMENTE
LIST OF SPARE PARTS WHICH CAN BE SUPPLIED SEPARATELY

CODICE CODE	DESCRIZIONE DESCRIPTION	Q.TÀ QTY
B518	CILINDRO MOTORE MOTOR CYLINDER	1
B560	ALBERO PISTONE PISTON	1
B562	TUBETTO RICIRCOLO ARIA AIR RECOVERY TUBE	1
B615	TUBO PESCANTE SUCTION TUBE	1
B616	CILINDRO BATTUTA VALVOLA BOTTOM VALVE CYLINDER	1
B617	STELO POMPANTE PUMPING ROD	1
B623	PROLUNGA PESCANTE SUCTION TUBE EXTENSION	1
B624	TERMINALE PESCANTE SHANK END	1
B626	GIUNTO MOTORE MOTOR COUPLING	1
B709	TUBO PESCANTE SUCTION TUBE	1
B710	STELO POMPANTE PUMPING ROD	1
B711	TUBO PESCANTE SUCTION TUBE	1
B712	STELO POMPANTE PUMPING ROD	1
KC468	PISTONE MOTORE PISTON	1
M094	VITE M8x20 SCREW M8x20	6
M100	VITE M12x25 SCREW M12x25	3
M519	SPINA ELASTICA PIN	2
M525	SPINA ELASTICA PIN	1
0004	FILTRO ARIA AIR FILTER	1
0009	SILENZIATORE MUFFLER	1
P041	GUANCIA SINISTRA LEFT COVER	1
P042	GUANCIA DESTRA RIGHT COVER	1
P099	PIASTRA SUPERIORE UPPER FLANGE	1
P100	PIASTRA INFERIORE LOWER FLANGE	1
P133	CORPO SUPERIORE UPPER BODY	1
P134	CORPO INFERIORE LOWER BODY	1

KIT GUARNIZIONI COMPLETI

TUTTE LE GUARNIZIONI (H...) MENZIONATE NELL'ESPLOSO SONO FORNIBILI ANCHE SINGOLARMENTE

COMPLETE GASKETS KIT

ALL THE O-RING (H...) MENTIONED IN THE EXPLODED VIEW CAN BE SUPPLIED SEPARATELY

CODICE CODE	DESCRIZIONE DESCRIPTION	Q.TÀ QTY
KR9061	KIT GUARNIZIONI MOTORE SUPERIORE GASKETS KIT FOR UPPER MOTOR	1
KR9062	KIT GUARNIZIONI PISTONE ø 150 GASKETS KIT FOR PISTON ø 150	1
KR9065	KIT GUARNIZIONI MOTORE INFERIORE GASKETS KIT FOR LOWER MOTOR	1
KR9066	KIT GUARNIZIONI PESCANTE GASKETS KIT FOR SUCTION TUBE	1

Art.
KS9088

SET RICAMBI CONSIGLIATI

AI PUNTI VENDITA E ASSISTENZA, COMPOSTO DAI RICAMBI SOTTO ELENCATI.

SPARE PARTS KIT ADVISED

TO THE SELLING CENTERS, THIS KIT INCLUDES ALL THE SPARE PARTS SHOWN HERE UNDER.

CODICE CODE	DESCRIZIONE DESCRIPTION	Q.TÀ QTY
KR9003	GRUPPO DISTRIBUZIONE ARIA SLIDE VALVE GROUP	1
KR9061	KIT GUARNIZIONI MOTORE SUPERIORE GASKETS KIT FOR UPPER MOTOR	1
KR9062	KIT GUARNIZIONI PISTONE ø 150 GASKETS KIT FOR PISTON ø 150	1
KR9065	KIT GUARNIZIONI MOTORE INFERIORE GASKETS KIT FOR LOWER MOTOR	1
KR9066	KIT GUARNIZIONI PESCANTE GASKETS KIT FOR SUCTION TUBE	1

RAASM

FLUIDS AND LUBRICATION EQUIPMENT



Art. 153F/701 Mod. 1500F-70160 - Art. 153FSP/701 Mod. 1500FSP-70160

VISTA ESPLOSA - EXPLODED VIEW



Art. 153F/701

Art. 153FSP/701

POMPA FLANGIATA S. 1500
R 70:1 - 7000 g/min
FLANGED PUMP S. 1500
R 70:1 - 7000 g/min

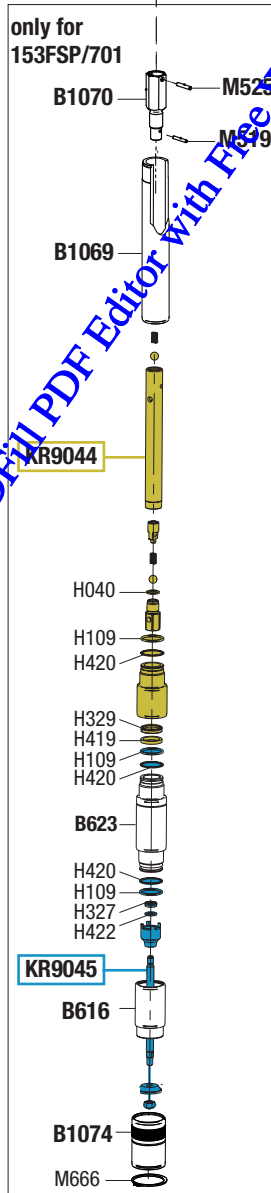
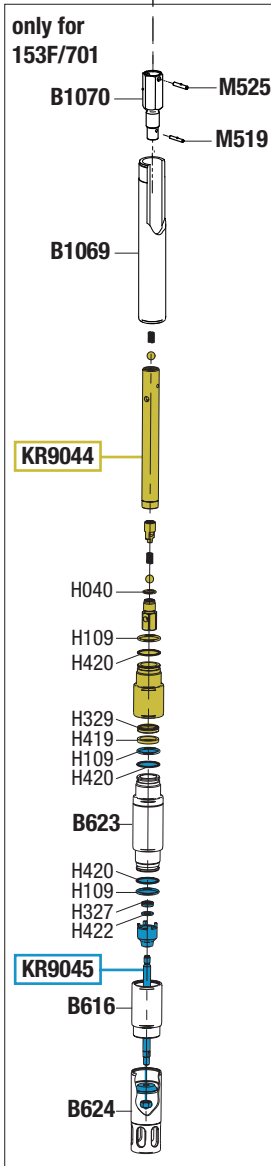
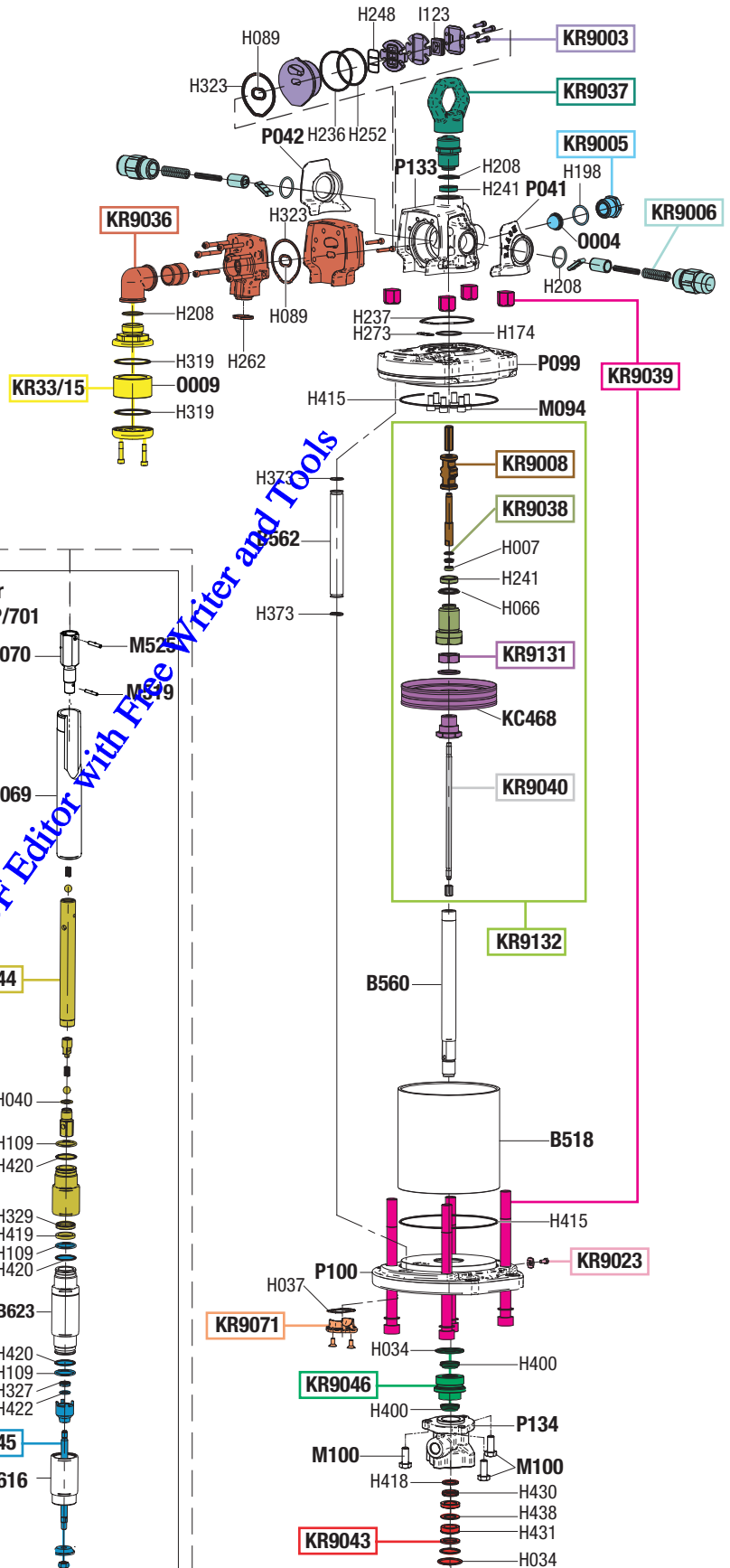

PDF Editor with Free Writer and Tools

GUIDA RICAMBI - SPARE PARTS GUIDE

KIT RICAMBI
OGNI KIT SOTTO RIPORTATO COMPRENDE I RICAMBI EVIDENZIATI CON LO STESSO COLORE E LE RELATIVE GUARNIZIONI. QUESTI RICAMBI NON SONO FORNIBILI SEPARATAMENTE TRANNE QUELLI CODIFICATI.

SPARE PARTS KITS

EACH KIT SHOWN WITH THE SAME COLOR INCLUDES ALSO THE GASKETS. THE SPARE PARTS INCLUDED IN THE KIT CAN'T BE SUPPLIED SEPARATELY EXCEPT THOSE SHOWN WITH A PROPER CODE.

CODICE CODE	DESCRIZIONE DESCRIPTION	Q.TÀ QTY
KR33/15	SILENZIATORE MUFFLER	1
KR9003	GRUPPO DISTRIBUTORE D'ARIA SLIDE VALVE GROUP	1
KR9005	RIDUZIONE ENTRATA AIR INLET CONNECTION	1
KR9006	BOSSOLI INVERTITORE BUSHES	1
KR9008	GRUPPO INVERTITORE PLUNGER GROUP	1
KR9023	MESSA A TERRA GROUNDED	1
KR9036	COLLETTORE DI SCARICO DISCHARGE CONNECTION	1
KR9037	BOSSOLO GUIDA STELO BUSH	1
KR9038	TAPPO SUPERIORE UPPER PLUG	1
KR9039	PRIGIONIERI STUD BOLTS	1
KR9040	ASTA INVERTITORE ROD	1
KR9043	GRUPPO TENUTA INFERIORE LOWER SEAL GROUP	1
KR9044	GRUPPO POMPANTE PUMPING GROUP	1
KR9045	FILTRO PESCANTE SHANK FILTER	1
KR9046	GRUPPO TENUTA SUPERIORE UPPER SEAL GROUP	1
KR9071	COLLETTORE MANIFOLD	1
KR9131	PISTONE MOTORE AIR PISTON	1
KR9132	GRUPPO DISTRIBUZIONE DISTRIBUTION GROUP	1

ELENCO RICAMBI FORNIBILI SINGOLARMENTE LIST OF SPARE PARTS WHICH CAN BE SUPPLIED SEPARATELY

CODICE CODE	DESCRIZIONE DESCRIPTION	Q.TÀ QTY
B518	CILINDRO MOTORE MOTOR CYLINDER	1
B560	ALBERO PISTONE PISTON	1
B562	TUBETTO RICIRCOLO ARIA AIR RECOVERY TUBE	1
B616	CILINDRO BATTUTA VALVOLA BOTTOM VALVE CYLINDER	1
B623	PROLUNGA PESCANTE SUCTION TUBE EXTENSION	1
B624	TERMINALE PESCANTE SHANK END	1
B1069	TUBO PESCANTE SUCTION TUBE	1
B1070	GIUNTO JOINT	1
B1074	TERMINALE PESCANTE SHANK END	1
KC468	PISTONE MOTORE PISTON	1
M094	VITE M8x20 SCREW M8x20	6
M100	VITE M12x25 SCREW M12x25	3
M519	SPINA ELASTICA PIN	1
M525	SPINA ELASTICA PIN	1
M666	SEEGER SEEGER	1
0004	FILTRO ARIA AIR FILTER	1
0009	SILENZIATORE MUFFLER	1
P041	GUANCIA SINISTRA LEFT COVER	1
P042	GUANCIA DESTRA RIGHT COVER	1
P099	PIASTRA SUPERIORE UPPER FLANGE	1
P100	PIASTRA INFERIORE LOWER FLANGE	1
P133	CORPO SUPERIORE UPPER BODY	1
P134	CORPO INFERIORE LOWER BODY	1

KIT GUARNIZIONI COMPLETI

TUTTE LE GUARNIZIONI (H...) MENZIONATE NELL'ESPLOSO SONO FORNIBILI ANCHE SINGOLARMENTE

COMPLETE GASKETS KIT

ALL THE O-RING (H...) MENTIONED IN THE EXPLODED VIEW CAN BE SUPPLIED SEPARATELY

CODICE CODE	DESCRIZIONE DESCRIPTION	Q.TÀ QTY
KR9061	KIT GUARNIZIONI MOTORE SUPERIORE GASKETS KIT FOR UPPER MOTOR	1
KR9062	KIT GUARNIZIONI PISTONE ø 150 GASKETS KIT FOR PISTON ø 150	1
KR9065	KIT GUARNIZIONI MOTORE INFERIORE GASKETS KIT FOR LOWER MOTOR	1
KR9066	KIT GUARNIZIONI PESCANTE GASKETS KIT FOR SUCTION TUBE	1

Art.
KS9088

SET RICAMBI CONSIGLIATI

AI PUNTI VENDITA E ASSISTENZA, COMPOSTO DAI RICAMBI SOTTO ELENCATI.

SPARE PARTS KIT ADVISED

TO THE SELLING CENTERS. THIS KIT INCLUDES ALL THE SPARE PARTS SHOWN HERE UNDER.

CODICE CODE	DESCRIZIONE DESCRIPTION	Q.TÀ QTY
KR9003	GRUPPO DISTRIBUZIONE ARIA SLIDE VALVE GROUP	1
KR9061	KIT GUARNIZIONI MOTORE SUPERIORE GASKETS KIT FOR UPPER MOTOR	1
KR9062	KIT GUARNIZIONI PISTONE ø 150 GASKETS KIT FOR PISTON ø 150	1
KR9065	KIT GUARNIZIONI MOTORE INFERIORE GASKETS KIT FOR LOWER MOTOR	1
KR9066	KIT GUARNIZIONI PESCANTE GASKETS KIT FOR SUCTION TUBE	1

RAASM

FLUIDS AND LUBRICATION EQUIPMENT



Art. 180D/51 Mod. 1800D-5100



VISTA ESPLOSA - EXPLODED VIEW

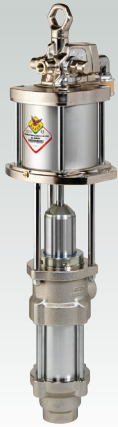

POMPA DISSOCIATA S.1800
R. 5:1 - 90 l/min
DIVORCED PUMP S.1800
R. 5:1 - 90 l/min

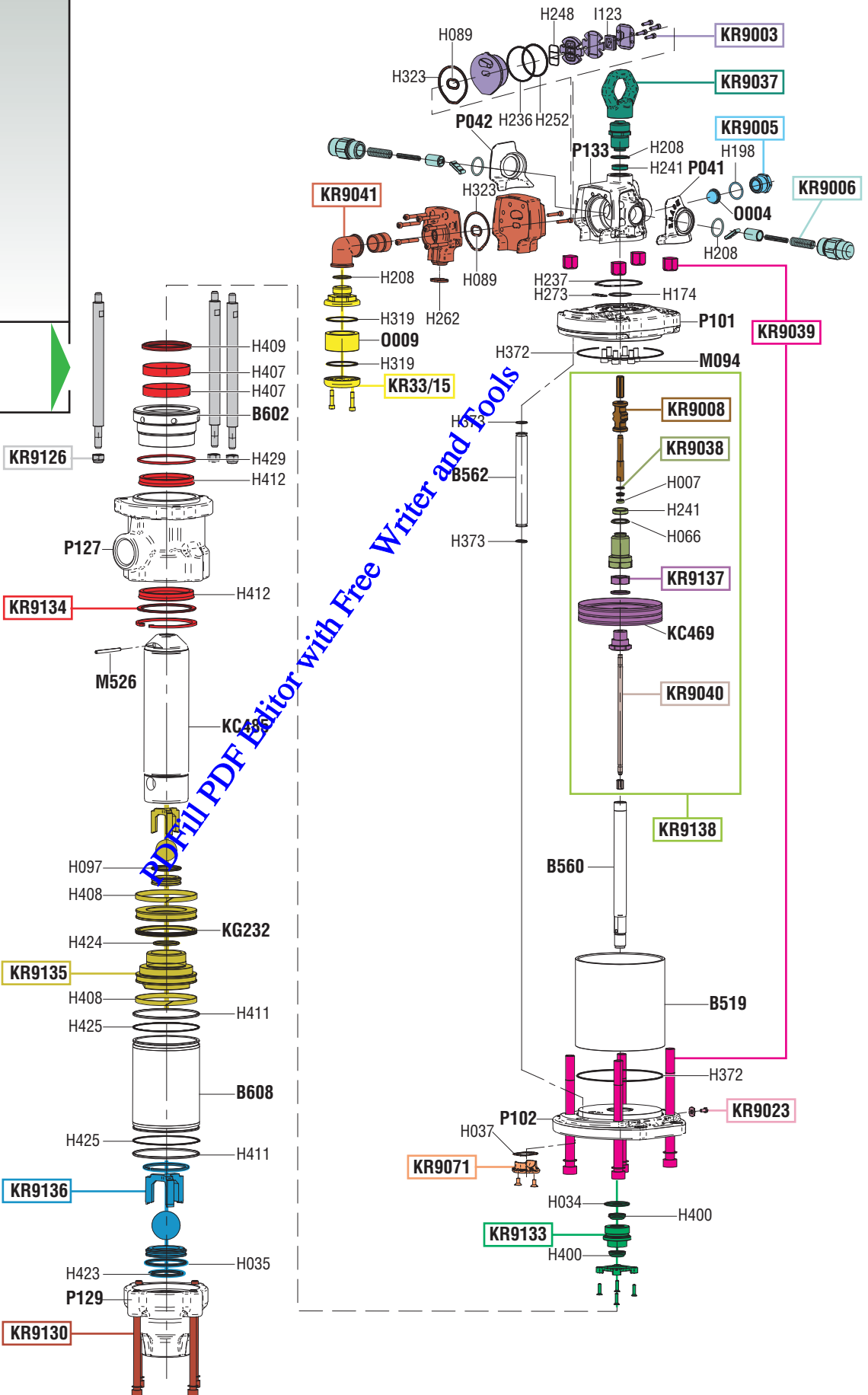

PDF Editor with Free Writer and Tools

tutti i diritti riservati - all rights reserved

GUIDA RICAMBI - SPARE PARTS GUIDE

KIT RICAMBI

OGNI KIT SOTTO RIPORTATO COMPRENDE I RICAMBI EVIDENZIATI CON LO STESSO COLORE E LE RELATIVE GUARNIZIONI. QUESTI RICAMBI NON SONO FORNIBILI SEPARATAMENTE TRANNE QUELLI CODIFICATI.

SPARE PARTS KITS

EACH KIT SHOWN WITH THE SAME COLOR INCLUDES ALSO THE GASKETS. THE SPARE PARTS INCLUDED IN THE KIT CAN'T BE SUPPLIED SEPARATELY EXCEPT THOSE SHOWN WITH A PROPER CODE.

CODICE CODE	DESCRIZIONE DESCRIPTION	Q.TÀ QTY
KR33/15	SILENZIATORE MUFFLER	1
KR9003	GRUPPO DISTRIBUTORE D'ARIA SLIDE VALVE GROUP	1
KR9005	RIDUZIONE ENTRATA AIR INLET CONNECTION	1
KR9006	BOSSOLI INVERTITORE BUSHES	1
KR9008	GRUPPO INVERTITORE PLUNGER GROUP	1
KR9023	MESSA A TERRA GROUNDED	1
KR9037	BOSSOLO GUIDA STELO BUSH	1
KR9038	TAPPO SUPERIORE UPPER PLUG	1
KR9039	PRIGIONIERI STUD BOLTS	1
KR9040	ASTA INVERTITORE ROD	1
KR9041	COLLETORE DI SCARICO DISCHARGE CONNECTION	1
KR9071	COLLETORE MANIFOLD	1
KR9126	PRIGIONIERI STUD BOLTS	1
KR9130	PRIGIONIERI STUD BOLTS	1
KR9133	GRUPPO TENUTA SUPERIORE UPPER SEAL GROUP	1
KR9134	GRUPPO TENUTA INFERIORE LOWER SEAL GROUP	1
KR9135	GRUPPO POMPANTE PUMPING GROUP	1
KR9136	VALVOLA DI FONDO BOTTOM VALVE	1
KR9137	PISTONE MOTORE AIR PISTON	1
KR9138	GRUPPO DISTRIBUZIONE DISTRIBUTION GROUP	1

ELENCO RICAMBI FORNIBILI SINGOLARMENTE
LIST OF SPARE PARTS WHICH CAN BE SUPPLIED SEPARATELY

CODICE CODE	DESCRIZIONE DESCRIPTION	Q.TÀ QTY
B519	CILINDRO MOTORE MOTOR CYLINDER	1
B560	ALBERO PISTONE PISTON	1
B562	TUBETTO RICIRCOLO ARIA AIR RECOVERY TUBE	1
B602	GHIERA CHIUSURA LOCKUP RING NUT	1
B608	TUBO PESCANTE SUCTION TUBE	1
KC469	PISTONE MOTORE PISTON	1
KC485	STELO POMPANTE PUMPING ROD	1
KG232	GUARNIZIONE PISTONE PISTON GASKET	1
M094	VITE M8x20 SCREW M8x20	6
M526	SPINA ELASTICA PIN	1
O004	FILTRO ARIA AIR FILTER	1
O009	SILENZIATORE MUFFLER	1
P041	GUANCIA SINISTRA LEFT COVER	1
P042	GUANCIA DESTRA RIGHT COVER	1
P101	PIASTRA SUPERIORE UPPER FLANGE	1
P102	PIASTRA INFERIORE LOWER FLANGE	1
P127	CORPO INFERIORE LOWER BODY	1
P129	CORPO INFERIORE PESCANTE LOWER SUCTION BODY	1
P133	CORPO SUPERIORE UPPER BODY	1

KIT GUARNIZIONI COMPLETI

TUTTE LE GUARNIZIONI (H...) MENZIONATE NELL'ESPLOSO SONO FORNIBILI ANCHE SINGOLARMENTE

COMPLETE GASKETS KIT

ALL THE O-RING (H...) MENTIONED IN THE EXPLODED VIEW CAN BE SUPPLIED SEPARATELY

CODICE CODE	DESCRIZIONE DESCRIPTION	Q.TÀ QTY
KR9063	KIT GUARNIZIONI MOTORE SUPERIORE GASKETS KIT FOR UPPER MOTOR	1
KR9064	KIT GUARNIZIONI PISTONE ø 180 GASKETS KIT FOR PISTON ø 180	1
KR9162	KIT GUARNIZIONI MOTORE INFERIORE GASKETS KIT FOR LOWER MOTOR	1
KR9163	KIT GUARNIZIONI PESCANTE GASKETS KIT FOR SUCTION TUBE	1

Art.
KS9192**SET RICAMBI CONSIGLIATI**

AI PUNTI VENDITA E ASSISTENZA, COMPOSTO DAI RICAMBI SOTTO ELENCATI.

SPARE PARTS KIT ADVISED

TO THE SELLING CENTERS, THIS KIT INCLUDES ALL THE SPARE PARTS SHOWN HERE UNDER.

CODICE CODE	DESCRIZIONE DESCRIPTION	Q.TÀ QTY
KR9003	GRUPPO DISTRIBUZIONE ARIA SLIDE VALVE GROUP	1
KR9063	KIT GUARNIZIONI MOTORE SUPERIORE GASKETS KIT FOR UPPER MOTOR	1
KR9064	KIT GUARNIZIONI PISTONE ø 180 GASKETS KIT FOR PISTON ø 180	1
KR9162	KIT GUARNIZIONI MOTORE INFERIORE GASKETS KIT FOR LOWER MOTOR	1
KR9163	KIT GUARNIZIONI PESCANTE GASKETS KIT FOR SUCTION TUBE	1

PDFill PDF Editor with Free Writer and Tools



Art. 180D/81 Mod. 1800D-8100



VISTA ESPLOSA - EXPLODED VIEW

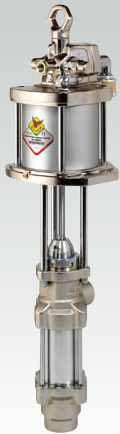

POMPA DISSOCIATA S.1800
R. 8:1 - 65 l/min
DIVORCED PUMP S.1800
R. 8:1 - 65 l/min

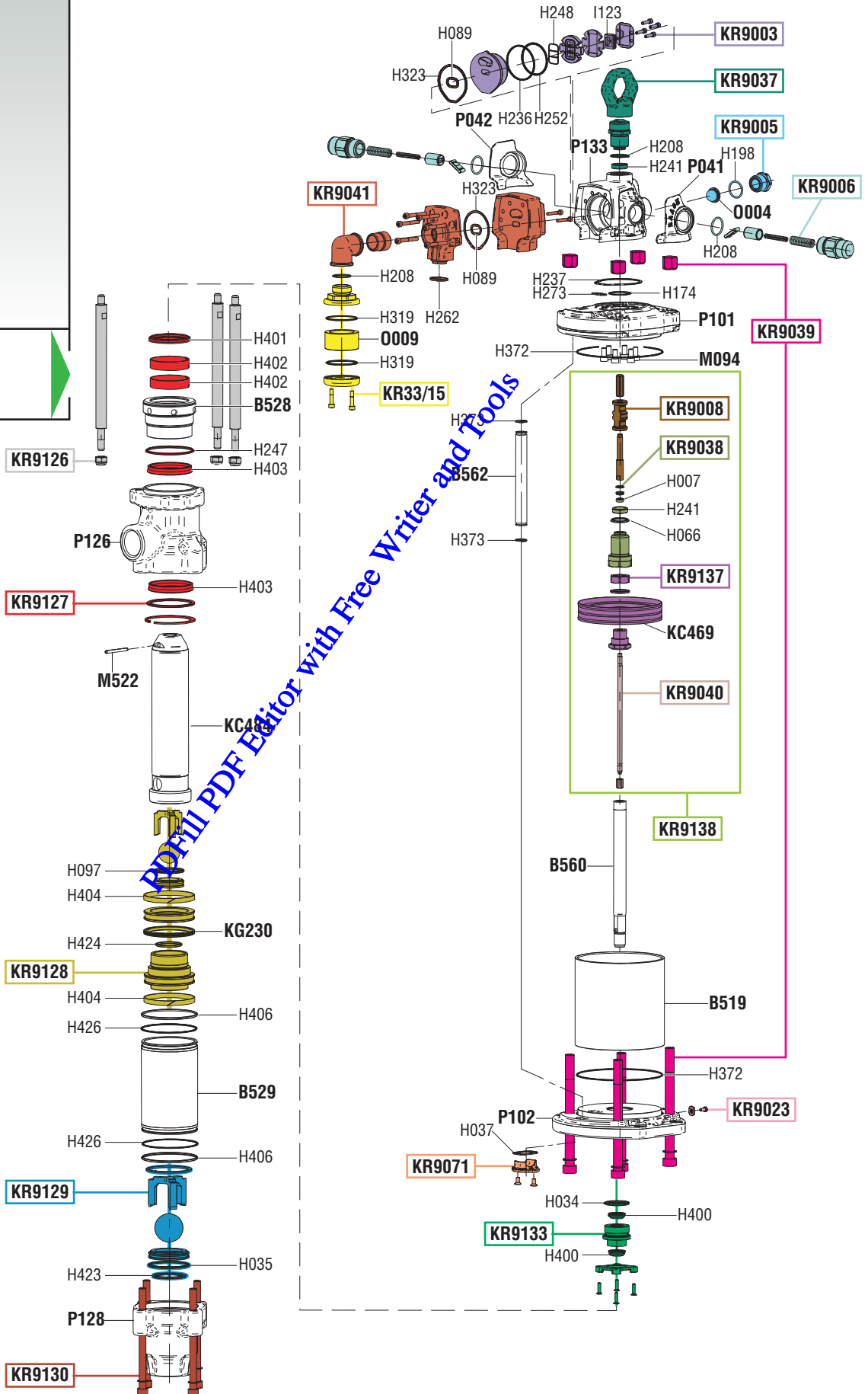

PDF Fill PDF Editor with Free Writer and Tools

tutti i diritti riservati - all rights reserved

GUIDA RICAMBI - SPARE PARTS GUIDE

KIT RICAMBI

OGNI KIT SOTTO RIPORTATO COMPRENDE I RICAMBI EVIDENZIATI CON LO STESSO COLORE E LE RELATIVE GUARNIZIONI. QUESTI RICAMBI NON SONO FORNIBILI SEPARATAMENTE TRANNE QUELLI CODIFICATI.

SPARE PARTS KITS

EACH KIT SHOWN WITH THE SAME COLOR INCLUDES ALSO THE GASKETS. THE SPARE PARTS INCLUDED IN THE KIT CAN'T BE SUPPLIED SEPARATELY EXCEPT THOSE SHOWN WITH A PROPER CODE.

CODICE CODE	DESCRIZIONE DESCRIPTION	Q.TÀ QTY
KR33/15	SILENZIATORE MUFFLER	1
KR9003	GRUPPO DISTRIBUTORE D'ARIA SLIDE VALVE GROUP	1
KR9005	RIDUZIONE ENTRATA AIR INLET CONNECTION	1
KR9006	BOSSOLI INVERTITORE BUSHES	1
KR9008	GRUPPO INVERTITORE PLUNGER GROUP	1
KR9023	MESSA A TERRA GROUNDED	1
KR9037	BOSSOLO GUIDA STELO BUSH	1
KR9038	TAPPO SUPERIORE UPPER PLUG	1
KR9039	PRIGIONIERI STUD BOLTS	1
KR9040	ASTA INVERTITORE ROD	1
KR9041	COLLETTORE DI SCARICO DISCHARGE CONNECTION	1
KR9071	COLLETTORE MANIFOLD	1
KR9126	PRIGIONIERI STUD BOLTS	1
KR9127	GRUPPO TENUTA INFERIORE LOWER SEAL GROUP	1
KR9128	GRUPPO POMPANTE PUMPING GROUP	1
KR9129	VALVOLA DI FONDO BOTTOM VALVE	1
KR9130	PRIGIONIERI STUD BOLTS	1
KR9133	GRUPPO TENUTA SUPERIORE UPPER SEAL GROUP	1
KR9137	PISTONE MOTORE AIR PISTON	1
KR9138	GRUPPO DISTRIBUZIONE DISTRIBUTION GROUP	1

ELENCO RICAMBI FORNIBILI SINGOLARMENTE
LIST OF SPARE PARTS WHICH CAN BE SUPPLIED SEPARATELY

CODICE CODE	DESCRIZIONE DESCRIPTION	Q.TÀ QTY
B519	CILINDRO MOTORE MOTOR CYLINDER	1
B528	GHIERA CHIUSURA LOCKUP RING NUT	1
B529	TUBO PESCANTE SUCTION TUBE	1
B560	ALBERO PISTONE PISTON	1
B562	TUBETTO RICIRCOLO ARIA AIR RECOVERY TUBE	1
KC469	PISTONE MOTORE PISTON	1
KC484	STELO POMPANTE PUMPING ROD	1
KG230	GUARNIZIONE PISTONE PISTON GASKET	1
M094	VITE M8x20 SCREW M8x20	6
M522	SPINA ELASTICA PIN	1
O004	FILTRO ARIA AIR FILTER	1
O009	SILENZIATORE MUFFLER	1
P041	GUANCIA SINISTRA LEFT COVER	1
P042	GUANCIA DESTRA RIGHT COVER	1
P101	PIASTRA SUPERIORE UPPER FLANGE	1
P102	PIASTRA INFERIORE LOWER FLANGE	1
P126	CORPO INFERIORE LOWER BODY	1
P128	CORPO INFERIORE PESCANTE LOWER SUCTION BODY	1
P133	CORPO SUPERIORE UPPER BODY	1

KIT GUARNIZIONI COMPLETI

TUTTE LE GUARNIZIONI (H...) MENZIONATE NELL'ESPLOSO SONO FORNIBILI ANCHE SINGOLARMENTE

COMPLETE GASKETS KIT

ALL THE O-RING (H...) MENTIONED IN THE EXPLODED VIEW CAN BE SUPPLIED SEPARATELY

CODICE CODE	DESCRIZIONE DESCRIPTION	Q.TÀ QTY
KR9063	KIT GUARNIZIONI MOTORE SUPERIORE GASKETS KIT FOR UPPER MOTOR	1
KR9064	KIT GUARNIZIONI PISTONE ø 180 GASKETS KIT FOR PISTON ø 180	1
KR9160	KIT GUARNIZIONI MOTORE INFERIORE GASKETS KIT FOR LOWER MOTOR	1
KR9161	KIT GUARNIZIONI PESCANTE GASKETS KIT FOR SUCTION TUBE	1

Art.
KS9193

SET RICAMBI CONSIGLIATI

AI PUNTI VENDITA E ASSISTENZA, COMPOSTO DAI RICAMBI SOTTO ELENCATI.

SPARE PARTS KIT ADVISED

TO THE SELLING CENTERS, THIS KIT INCLUDES ALL THE SPARE PARTS SHOWN HERE UNDER.

CODICE CODE	DESCRIZIONE DESCRIPTION	Q.TÀ QTY
KR9003	GRUPPO DISTRIBUZIONE ARIA SLIDE VALVE GROUP	1
KR9063	KIT GUARNIZIONI MOTORE SUPERIORE GASKETS KIT FOR UPPER MOTOR	1
KR9064	KIT GUARNIZIONI PISTONE ø 180 GASKETS KIT FOR PISTON ø 180	1
KR9160	KIT GUARNIZIONI MOTORE INFERIORE GASKETS KIT FOR LOWER MOTOR	1
KR9161	KIT GUARNIZIONI PESCANTE GASKETS KIT FOR SUCTION TUBE	1

RAASM

FLUIDS AND LUBRICATION EQUIPMENT

GUIDA RICAMBI - SPARE PARTS GUIDE

KIT RICAMBI

OGNI KIT SOTTO RIPORTATO COMPRENDE I RICAMBI EVIDENZIATI CON LO STESSO COLORE E LE RELATIVE GUARNIZIONI. QUESTI RICAMBI NON SONO FORNIBILI SEPARATAMENTE TRANNE QUELLI CODIFICATI.

SPARE PARTS KITS

EACH KIT SHOWN WITH THE SAME COLOR INCLUDES ALSO THE GASKETS. THE SPARE PARTS INCLUDED IN THE KIT CAN'T BE SUPPLIED SEPARATELY EXCEPT THOSE SHOWN WITH A PROPER CODE.

CODICE CODE	DESCRIZIONE DESCRIPTION	Q.TÀ QTY
KR33/15	SILENZIATORE MUFFLER	1
KR9003	GRUPPO DISTRIBUTORE D'ARIA SLIDE VALVE GROUP	1
KR9005	RIDUZIONE ENTRATA AIR INLET CONNECTION	1
KR9006	BOSSOLI INVERTITORE BUSHES	1
KR9008	GRUPPO INVERTITORE PLUNGER GROUP	1
KR9023	MESSA A TERRA GROUNDED	1
KR9037	BOSSOLO GUIDA STELO BUSH	1
KR9038	TAPPO SUPERIORE UPPER PLUG	1
KR9039	PRIGIONIERI STUD BOLTS	1
KR9040	ASTA INVERTITORE ROD	1
KR9041	COLLETTORE DI SCARICO DISCHARGE CONNECTION	1
KR9071	COLLETTORE MANIFOLD	1
KR9126	PRIGIONIERI STUD BOLTS	1
KR9130	PRIGIONIERI STUD BOLTS	1
KR9133	GRUPPO TENUTA SUPERIORE UPPER SEAL GROUP	1
KR9137	PISTONE MOTORE AIR PISTON	1
KR9138	GRUPPO DISTRIBUZIONE DISTRIBUTION GROUP	1
KR9139	GRUPPO TENUTA INFERIORE LOWER SEAL GROUP	1
KR9140	VALVOLA DI FONDO BOTTOM VALVE	1
KR9141	PISTONE POMPANTE PUMPING PISTON	1

ELENCO RICAMBI FORNIBILI SINGOLARMENTE
LIST OF SPARE PARTS WHICH CAN BE SUPPLIED SEPARATELY

CODICE CODE	DESCRIZIONE DESCRIPTION	Q.TÀ QTY
B519	CILINDRO MOTORE MOTOR CYLINDER	1
B528	GHIERA CHIUSURA LOCKUP RING NUT	1
B529	TUBO PESCANTE SUCTION TUBE	1
B560	ALBERO PISTONE PISTON	1
B562	TUBETTO RICIRCOLO ARIA AIR RECOVERY TUBE	1
KC469	PISTONE MOTORE PISTON	1
KC484	STELO POMPANTE PUMPING ROD	1
KG254	GUARNIZIONE PISTONE PISTON GASKET	1
M094	VITE M8x20 SCREW M8x20	6
M522	SPINA ELASTICA PIN	1
O004	FILTRO ARIA AIR FILTER	1
O009	SILENZIATORE MUFFLER	1
P041	GUANCIA SINISTRA LEFT COVER	1
P042	GUANCIA DESTRA RIGHT COVER	1
P101	PIASTRA SUPERIORE UPPER FLANGE	1
P102	PIASTRA INFERIORE LOWER FLANGE	1
P126	CORPO INFERIORE LOWER BODY	1
P128	CORPO INFERIORE PESCANTE LOWER SUCTION BODY	1
P133	CORPO SUPERIORE UPPER BODY	1

KIT GUARNIZIONI COMPLETI

TUTTE LE GUARNIZIONI (H...) MENZIONATE NELL'ESPLOSO SONO FORNIBILI ANCHE SINGOLARMENTE

COMPLETE GASKETS KIT

ALL THE O-RING (H...) MENTIONED IN THE EXPLODED VIEW CAN BE SUPPLIED SEPARATELY

CODICE CODE	DESCRIZIONE DESCRIPTION	Q.TÀ QTY
KR9063	KIT GUARNIZIONI MOTORE SUPERIORE GASKETS KIT FOR UPPER MOTOR	1
KR9064	KIT GUARNIZIONI PISTONE ø 180 GASKETS KIT FOR PISTON ø 180	1
KR9164	KIT GUARNIZIONI MOTORE INFERIORE GASKETS KIT FOR LOWER MOTOR	1
KR9165	KIT GUARNIZIONI PESCANTE GASKETS KIT FOR SUCTION TUBE	1

Art.
KS9094**SET RICAMBI CONSIGLIATI**

AI PUNTI VENDITA E ASSISTENZA, COMPOSTO DAI RICAMBI SOTTO ELENCATI.

SPARE PARTS KIT ADVISED

TO THE SELLING CENTERS, THIS KIT INCLUDES ALL THE SPARE PARTS SHOWN HERE UNDER.

CODICE CODE	DESCRIZIONE DESCRIPTION	Q.TÀ QTY
KR9003	GRUPPO DISTRIBUZIONE ARIA SLIDE VALVE GROUP	1
KR9063	KIT GUARNIZIONI MOTORE SUPERIORE GASKETS KIT FOR UPPER MOTOR	1
KR9064	KIT GUARNIZIONI PISTONE ø 180 GASKETS KIT FOR PISTON ø 180	1
KR9164	KIT GUARNIZIONI MOTORE INFERIORE GASKETS KIT FOR LOWER MOTOR	1
KR9165	KIT GUARNIZIONI PESCANTE GASKETS KIT FOR SUCTION TUBE	1



Art. 22017 Mod. NEB.16L - Art. 22017/N Mod. NEB.16L



VISTA ESPLOSA - EXPLODED VIEW

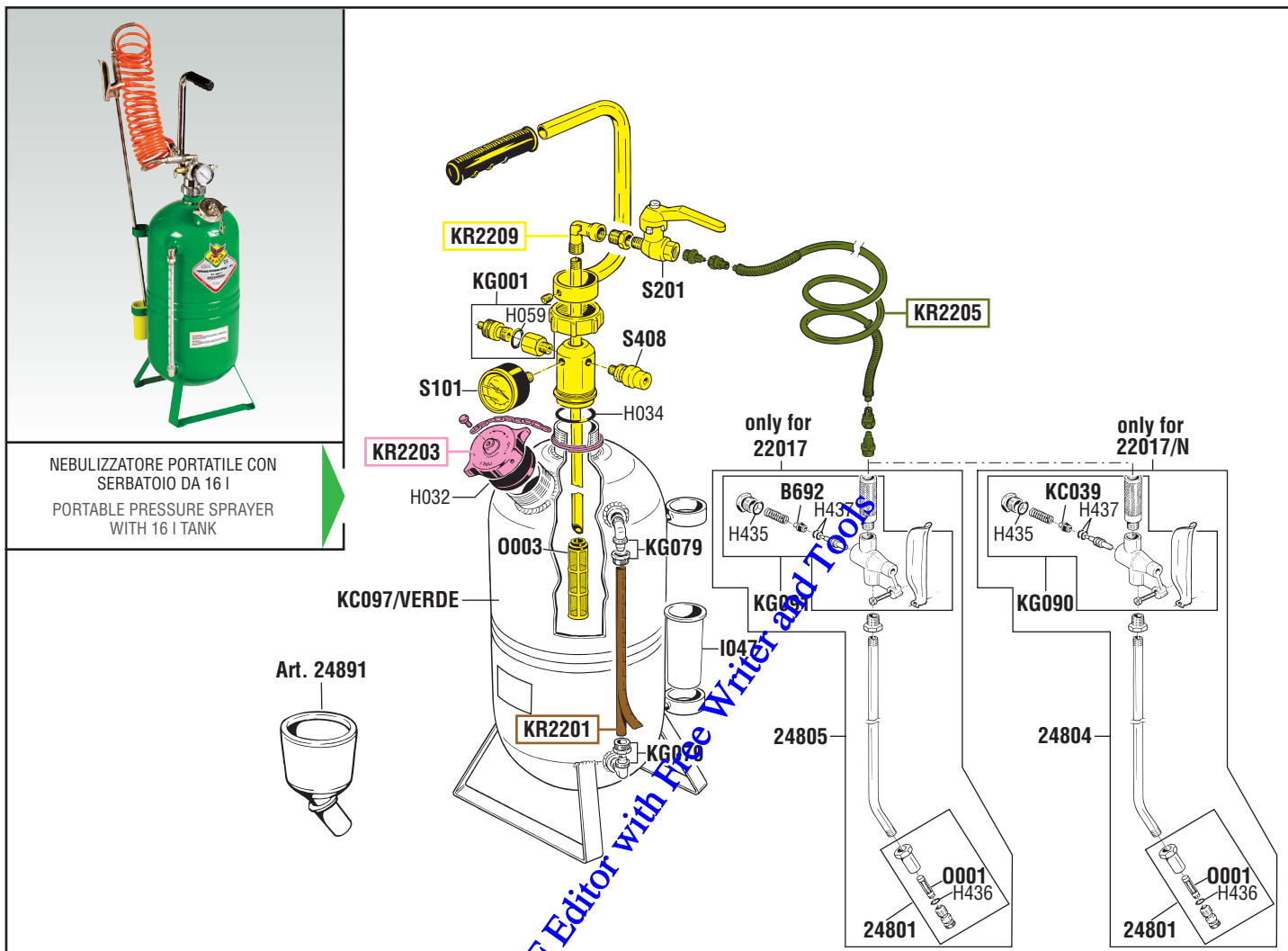

tutti i diritti riservati - all rights reserved

GUIDA RICAMBI - SPARE PARTS GUIDE

KIT RICAMBI
OGNI KIT SOTTO RIPORTATO COMPRENDE I RICAMBI EVIDENZIATI CON LO STESSO COLORE E LE RELATIVE GUARNIZIONI. QUESTI RICAMBI NON SONO FORNIBILI SEPARATAMENTE TRANNE QUELLI CODIFICATI.

SPARE PARTS KITS
EACH KIT SHOWN WITH THE SAME COLOR INCLUDES ALSO THE GASKETS. THE SPARE PARTS INCLUDED IN THE KIT CAN'T BE SUPPLIED SEPARATELY EXCEPT THOSE SHOWN WITH A PROPER CODE.

CODICE CODE	DESCRIZIONE DESCRIPTION	Q.TÀ QTY
KR2201	TUBO DI LIVELLO ED ETICHETTA GAUGE TUBE AND LABEL	1
KR2203	TAPPO ALTA PRESSIONE HIGH PRESSURE PLUG	1
KR2205	TUBO COLLEGAMENTO CONNECTION HOSE	1
KR2209	GRUPPO SUPERIORE SERBATOIO UPPER GROUP FOR RESERVOIR	1

ELENCO RICAMBI FORNIBILI SINGOLARMENTE
LIST OF SPARE PARTS WHICH CAN BE SUPPLIED SEPARATELY

CODICE CODE	DESCRIZIONE DESCRIPTION	Q.TÀ QTY
24801	UGELLO COMPLETO COMPLETE NOZZLE	1
24804	PISTOLA NEBULIZZATORE CON GUARN. "NBR" SPRAYER GUN WITH "NBR" SEALS	1
24805	PISTOLA NEBULIZZATORE CON GUARN. "EPDM" SPRAYER GUN WITH "EPDM" SEALS	1
24891	IMBUTO FUNNEL	1
I047	BICCHIERE RACCOGLIGOCCE DRIP COLLECTOR	1
KC039	VALVOLA VULCANIZZATA PISTOLA OLIO OIL VULCANIZED VALVE	1
KC097/VERDE	SERBATOIO 16 L RESERVOIR 16 L	1
KG001	RUBINETTO UNIVERSALE CARICA ARIA UNIVERSAL AIR TAP	1
KG079	GRUPPO GOMITO E GHIERA RING AND ELBOW JOINT GROUP	2
KG090	IMPUGNATURA PISTOLA GUN GRIP	1
KG091	IMPUGNATURA PISTOLA GUN GRIP	1
0003	FILTRO FILTER	1
S101	MANOMETRO ø 50 mm GAUGE ø 50 mm	1
S201	RUBINETTO A SFERA 1/4" BALL VALVE 1/4"	1
S408	VALVOLA SICUREZZA 10 bar SAFETY VALVE 10 bar	1

Art. KR2250	KIT GUARNIZIONI COMPLETO COMPOSTO DALLE GUARNIZIONI SOTTO ELENCAE JOINTS GASKETS LIST INCLUDING ALL THE GASKETS SHOWN HERE UNDER	Q.TÀ QTY
H032	GUARNIZIONE TAPPO GASKET	1
H034	O-RING 3156	1
H059	O-RING 2037	1
H435	O-RING 2050 "EPDM"	1
H436	O-RING 106 "EPDM"	1
H437	O-RING 2021 "EPDM"	2
B692	VALVOLA PISTOLA "TEFLON" GUN VALVE "TEFLON"	1
0001	FILTRO ATTACCO RAPIDO QUICK CONNECTOR FILTER	1

Art. KS2280	SET RICAMBI CONSIGLIATI AI PUNTI VENDITA E ASSISTENZA. COMPOSTO DAI RICAMBI SOTTO ELENCAE SPARE PARTS KIT ADVISED TO THE REPAIR CENTERS. THIS KIT INCLUDES ALL THE SPARE PARTS SHOWN HERE UNDER	Q.TÀ QTY
24801	UGELLO COMPLETO COMPLETE NOZZLE	1
KR2250	KIT GUARNIZIONI COMPLETO COMPLETE GASKETS KIT	1
0003	FILTRO FILTER	1
S101	MANOMETRO ø 50 mm GAUGE ø 50 mm	1



Art. 22024 Mod. NEB.24L - Art. 22024/N Mod. NEB.24L

VISTA ESPLOSA - EXPLODED VIEW

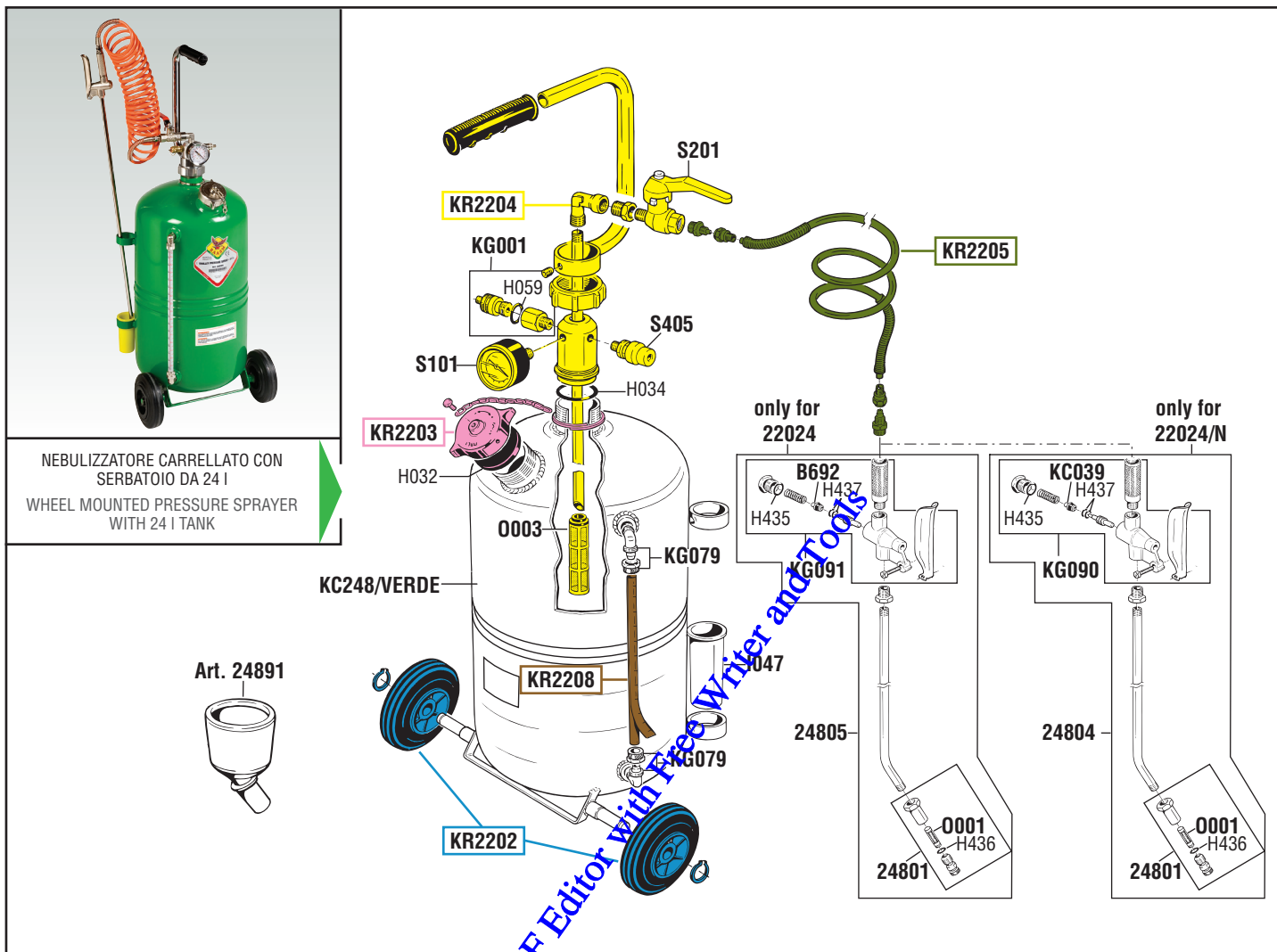

NEBULIZZATORE CARRELLATO CON SERBATOIO DA 24 l
WHEEL MOUNTED PRESSURE SPRAYER WITH 24 l TANK

Art. 24891



GUIDA RICAMBI - SPARE PARTS GUIDE

KIT RICAMBI
OGNI KIT SOTTO RIPORTATO COMPRENDE I RICAMBI EVIDENZIATI CON LO STESSO COLORE E LE RELATIVE GUARNIZIONI. QUESTI RICAMBI NON SONO FORNIBILI SEPARATAMENTE TRANNE QUELLI CODIFICATI.
SPARE PARTS KITS
EACH KIT SHOWN WITH THE SAME COLOR INCLUDES ALSO THE GASKETS. THE SPARE PARTS INCLUDED IN THE KIT CAN'T BE SUPPLIED SEPARATELY EXCEPT THOSE SHOWN WITH A PROPER CODE.

CODICE CODE	DESCRIZIONE DESCRIPTION	Q.TÀ QTY
KR2202	DUE RUOTE FISSE CON ANELLI ELASTICI TWO FIXED WHEELS WITH RETAINING RINGS	1
KR2203	TAPPO ALTA PRESSIONE HIGH PRESSURE PLUG	1
KR2204	GRUPPO SUPERIORE SERBATOIO 24 l UPPER GROUP FOR 24 l RESERVOIR	1
KR2205	TUBO COLLEGAMENTO CONNECTION HOSE	1
KR2208	TUBO DI LIVELLO CON ETICHETTA GAUGE TUBE WITH LABEL	1

ELENCO RICAMBI FORNIBILI SINGOLARMENTE
LIST OF SPARE PARTS WHICH CAN BE SUPPLIED SEPARATELY

CODICE CODE	DESCRIZIONE DESCRIPTION	Q.TÀ QTY
24804	PISTOLA NEBULIZZATORE CON GUARN. "NBR" SPRAYER GUN WITH "NBR" SEALS	1
24805	PISTOLA NEBULIZZATORE CON GUARN. "EPDM" SPRAYER GUN WITH "EPDM" SEALS	1
24891	IMBUTO FUNNEL	1
I047	BICCHIERE RACCOLGIGOCCE DRIP COLLECTOR	1
KC039	VALVOLA VULCANIZZATA PISTOLA OLIO OIL VULCANIZED VALVE	1
KC248/VERDE	SERBATOIO 24 l RESERVOIR 24 l	1
KG001	RUBINETTO UNIVERSALE CARICA ARIA UNIVERSAL AIR TAP	1
KG079	GRUPPO GOMITO E GHIERA RING AND ELBOW JOINT GROUP	2
KG090	IMPUGNATURA PISTOLA GUN GRIP	1
KG091	IMPUGNATURA PISTOLA GUN GRIP	1
0003	FILTRO FILTER	1
S101	MANOMETRO ø 50 mm GAUGE ø 50 mm	1
S201	RUBINETTO A SFERA 1/4" BALL VALVE 1/4"	1
S405	VALVOLA SICUREZZA 8 bar SAFETY VALVE 8 bar	1

Art. KR2250 KIT GUARNIZIONI COMPLETO
COMPOSTO DALLE GUARNIZIONI SOTTO ELENCAE
JOINTS GASKETS LIST
INCLUDING ALL THE GASKETS SHOWN HERE UNDER

CODICE CODE	DESCRIZIONE DESCRIPTION	Q.TÀ QTY
H032	GUARNIZIONE TAPPO GASKET	1
H034	O-RING 3156 O-RING 3156	1
H059	O-RING 2037 O-RING 2037	1
H435	O-RING 2050 "EPDM" O-RING 2050 "EPDM"	1
H436	O-RING 106 "EPDM" O-RING 106 "EPDM"	1
H437	O-RING 2021 "EPDM" O-RING 2021 "EPDM"	2
B692	VALVOLA PISTOLA "TEFLON" GUN VALVE "TEFLON"	1
0001	FILTRO ATTACCO RAPIDO QUICK CONNECTOR FILTER	1

Art. KS2280 SET RICAMBI CONSIGLIATI
AI PUNTI VENDITA E ASSISTENZA. COMPOSTO DAI RICAMBI SOTTO ELENCAE
SPARE PARTS KIT ADVISED
TO THE REPAIR CENTERS. THIS KIT INCLUDES ALL THE SPARE PARTS SHOWN HERE UNDER

CODICE CODE	DESCRIZIONE DESCRIPTION	Q.TÀ QTY
24801	UGELLO COMPLETO COMPLETE NOZZLE	1
KR2250	KIT GUARNIZIONI COMPLETO COMPLETE GASKETS KIT	1
0003	FILTRO FILTER	1
S101	MANOMETRO ø 50 mm GAUGE ø 50 mm	1

tutti i diritti riservati - all rights reserved



Art. 23024 Mod. NEB.I 24L - Art. 23024/N Mod. NEB.I 24L

VISTA ESPLOSA - EXPLODED VIEW



NEBULIZZATORE CARRELLATO INOX
VERNICIATO CON SERBATOIO DA 24 l
PAINTED STAINLESS STEEL WHEEL-MOUNTED
PRESSURE SPRAYER WITH 24 l TANK

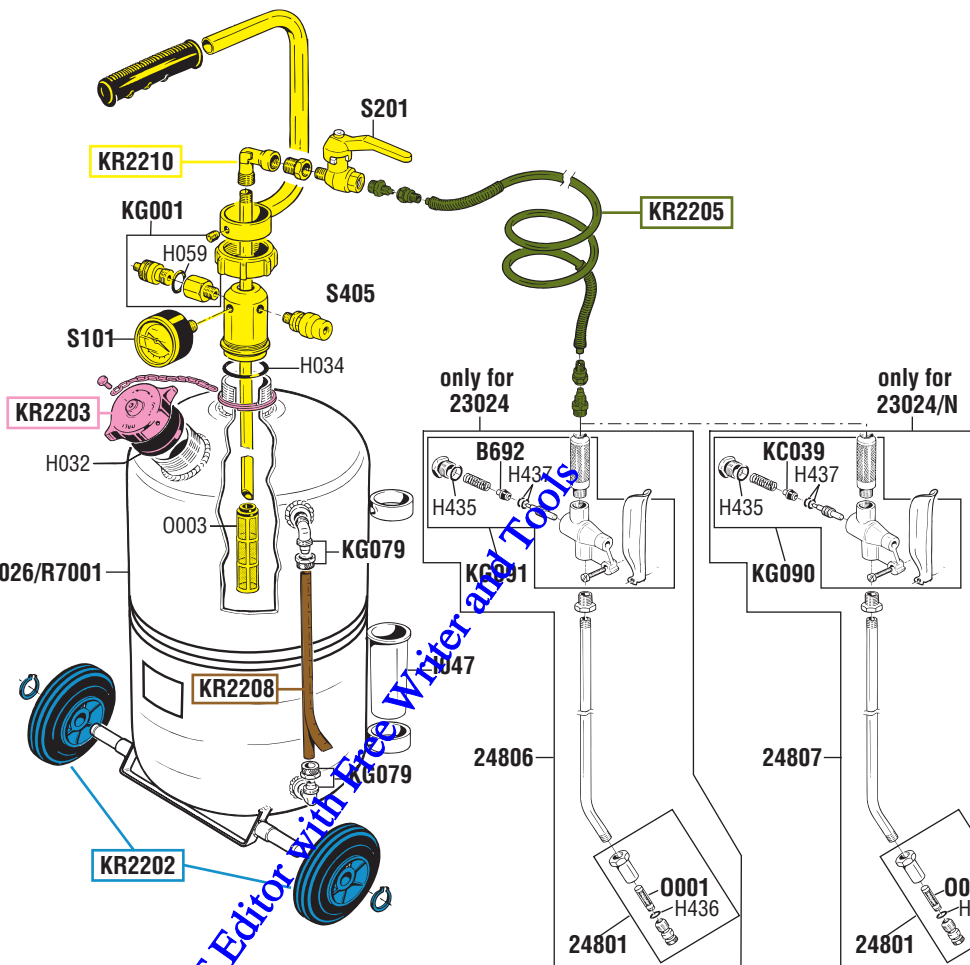

Art. 24891



GUIDA RICAMBI - SPARE PARTS GUIDE

KIT RICAMBI
OGNI KIT SOTTO RIPORTATO COMPRENDE I RICAMBI EVIDENZIATI CON LO STESSO COLORE E LE RELATIVE GUARNIZIONI. QUESTI RICAMBI NON SONO FORNIBILI SEPARATAMENTE TRANNE QUELLI CODIFICATI.

SPARE PARTS KITS

EACH KIT SHOWN WITH THE SAME COLOR INCLUDES ALSO THE GASKETS. THE SPARE PARTS INCLUDED IN THE KIT CAN'T BE SUPPLIED SEPARATELY EXCEPT THOSE SHOWN WITH A PROPER CODE.

CODICE CODE	DESCRIZIONE DESCRIPTION	Q.TÀ QTY
KR2202	DUE RUOTE Fisse CON ANELLI ELASTICI TWO FIXED WHEELS WITH RETAINING RINGS	1
KR2203	TAPPO ALTA PRESSIONE HIGH PRESSURE PLUG	1
KR2205	TUBO COLLEGAMENTO CONNECTION HOSE	1
KR2208	TUBO LIVELLO CON ETICHETTA GAUGE TUBE WITH LABEL	1
KR2210	GRUPPO SUPERIORE SERBATOIO UPPER GROUP FOR RESERVOIR	1

ELENCO RICAMBI FORNIBILI SINGOLARMENTE
LIST OF SPARE PARTS WHICH CAN BE SUPPLIED SEPARATELY

CODICE CODE	DESCRIZIONE DESCRIPTION	Q.TÀ QTY
24801	UGELLO COMPLETO COMPLETE NOZZLE	1
24806	PISTOLA NEBUL. INOX CON GUARN. "EPDM" S. STEEL SPRAYER GUN WITH "EPDM" SEALS	1
24807	PISTOLA NEBULIZZATORE CON GUARN. "NBR" SPRAYER GUN WITH "NBR" SEALS	1
24891	IMBUTO FUNNEL	1
IO47	BICCHIERE RACCOGLIGOCCE DRIP COLLECTOR	1
KC026/R7001	SERBATOIO 24 l RESERVOIR 24 l	1
KC039	VALVOLA VULCANIZZATA PISTOLA OLIO OIL VULCANIZED VALVE	1
KG001	RUBINETTO UNIVERSALE CARICA ARIA UNIVERSAL AIR TAP	1
KG079	GRUPPO GOMITO E GHIERA RING AND ELBOW JOINT GROUP	2
KG090	IMPUGNATURA PISTOLA GUN GRIP	1
KG091	IMPUGNATURA PISTOLA GUN GRIP	1
0003	FILTRO FILTER	1
S101	MANOMETRO ø 50 mm GAUGE ø 50 mm	1
S201	RUBINETTO A SFERA 1/4" BALL VALVE 1/4"	1
S405	VALVOLA SICUREZZA 8 bar SAFETY VALVE 8 bar	1

Art. KR2250 **KIT GUARNIZIONI COMPLETO**
COMPOSTO DALLE GUARNIZIONI SOTTO ELENCAE
JOINTS GASKETS LIST
INCLUDING ALL THE GASKETS SHOWN HERE UNDER

CODICE CODE	DESCRIZIONE DESCRIPTION	Q.TÀ QTY
H032	GUARNIZIONE TAPPO GASKET	1
H034	O-RING 3156 O-RING 3156	1
H059	O-RING 2037 O-RING 2037	1
H435	O-RING 2050 "EPDM" O-RING 2050 "EPDM"	1
H436	O-RING 106 "EPDM" O-RING 106 "EPDM"	1
H437	O-RING 2021 "EPDM" O-RING 2021 "EPDM"	2
B692	VALVOLA PISTOLA "TEFLON" GUN VALVE "TEFLON"	1
0001	FILTRO ATTACCO RAPIDO QUICK CONNECTOR FILTER	1

Art. KS2280 **SET RICAMBI CONSIGLIATI**
AI PUNTI VENDITA E ASSISTENZA.
COMPOSTO DAI RICAMBI SOTTO ELENCAE
SPARE PARTS KIT ADVISED
TO THE REPAIR CENTERS. THIS KIT INCLUDES
ALL THE SPARE PARTS SHOWN HERE UNDER

CODICE CODE	DESCRIZIONE DESCRIPTION	Q.TÀ QTY
24801	UGELLO COMPLETO COMPLETE NOZZLE	1
KR2250	KIT GUARNIZIONI COMPLETO COMPLETE GASKETS KIT	1
0003	FILTRO FILTER	1
S101	MANOMETRO ø 50 mm GAUGE ø 50 mm	1

tutti i diritti riservati - all rights reserved



Art. 23025 Mod. NEB.I 24L - Art. 23025/N Mod. NEB.I 24L

VISTA ESPLOSA - EXPLODED VIEW

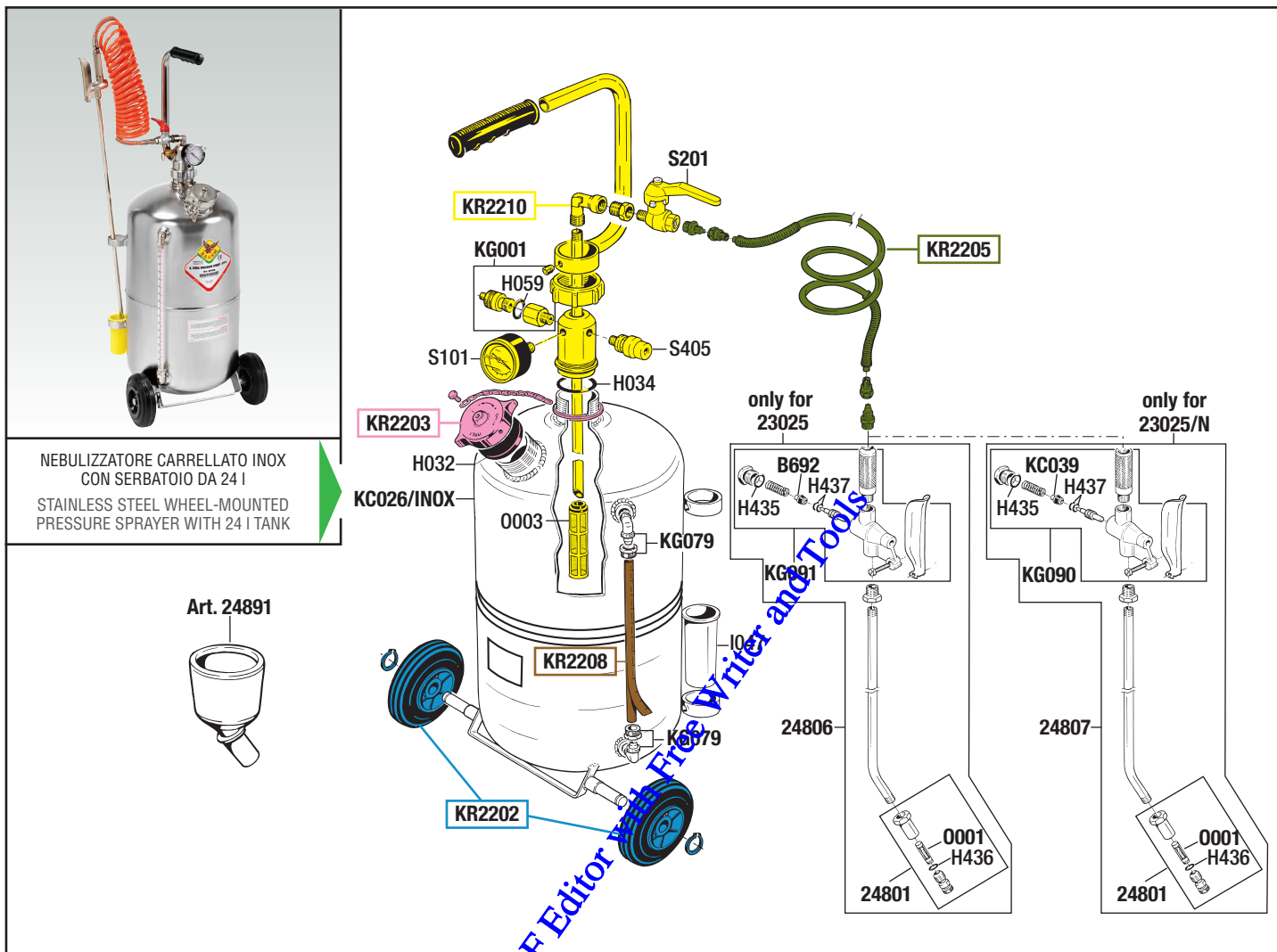

tutti i diritti riservati - all rights reserved

GUIDA RICAMBI - SPARE PARTS GUIDE

KIT RICAMBI
OGNI KIT SOTTO RIPORTATO COMPRENDE I RICAMBI EVIDENZIATI CON LO STESSO COLORE E LE RELATIVE GUARNIZIONI. QUESTI RICAMBI NON SONO FORNIBILI SEPARATAMENTE TRANNE QUELLI CODIFICATI.

SPARE PARTS KITS
EACH KIT SHOWN WITH THE SAME COLOR INCLUDES ALSO THE GASKETS. THE SPARE PARTS INCLUDED IN THE KIT CAN'T BE SUPPLIED SEPARATELY EXCEPT THOSE SHOWN WITH A PROPER CODE.

CODICE CODE	DESCRIZIONE DESCRIPTION	Q.TÀ QTY
KR2202	DUE RUOTE Fisse CON ANELLI ELASTICI TWO FIXED WHEELS WITH RETAINING RINGS	1
KR2203	TAPPO ALTA PRESSIONE HIGH PRESSURE PLUG	1
KR2205	TUBO COLLEGAMENTO CONNECTION HOSE	1
KR2208	TUBO LIVELLO CON ETICHETTA GAUGE TUBE WITH LABEL	1
KR2210	GRUPPO SUPERIORE SERBATOIO UPPER GROUP FOR RESERVOIR	1

ELENCO RICAMBI FORNIBILI SINGOLARMENTE
LIST OF SPARE PARTS WHICH CAN BE SUPPLIED SEPARATELY

CODICE CODE	DESCRIZIONE DESCRIPTION	Q.TÀ QTY
24801	UGELLO COMPLETO COMPLETE NOZZLE	1
24806	PISTOLA NEBUL. INOX CON GUARN. "EPDM" S. STEEL SPRAYER GUN WITH "EPDM" SEALS	1
24891	IMBUTO FUNNEL	1
I047	BICCHIERE RACCOLGIGOCCE DRIP COLLECTOR	1
KC026/INOX	SERBATOIO 24 l RESERVOIR 24 l	1
KG001	RUBINETTO UNIVERSALE CARICA ARIA UNIVERSAL AIR TAP	1
KG079	GRUPPO GOMITO E GHIERA RING AND ELBOW JOINT GROUP	2
KG090	IMPUGNATURA PISTOLA GUN GRIP	1
KG091	IMPUGNATURA PISTOLA GUN GRIP	1
O003	FILTRO FILTER	1
S101	MANOMETRO ø 50 mm GAUGE ø 50 mm	1
S201	RUBINETTO A SFERA 1/4" BALL VALVE 1/4"	1
S405	VALVOLA SICUREZZA 8 bar SAFETY VALVE 8 bar	1

Art. KR2250 **KIT GUARNIZIONI COMPLETO**
COMPOSTO DALLE GUARNIZIONI SOTTO ELENCAE
JOINTS GASKETS LIST
INCLUDING ALL THE GASKETS SHOWN HERE UNDER

CODICE CODE	DESCRIZIONE DESCRIPTION	Q.TÀ QTY
H032	GUARNIZIONE TAPPO GASKET	1
H034	O-RING 3156 O-RING 3156	1
H059	O-RING 2037 O-RING 2037	1
H435	O-RING 2050 "EPDM" O-RING 2050 "EPDM"	1
H436	O-RING 106 "EPDM" O-RING 106 "EPDM"	1
H437	O-RING 2021 "EPDM" O-RING 2021 "EPDM"	2
B692	VALVOLA PISTOLA "TEFLON" GUN VALVE "TEFLON"	1
O001	FILTRO ATTACCO RAPIDO QUICK CONNECTOR FILTER	1

Art. KS2280 **SET RICAMBI CONSIGLIATI**
AI PUNTI VENDITA E ASSISTENZA.
COMPOSTO DAI RICAMBI SOTTO ELENCAE
SPARE PARTS KIT ADVISED
TO THE REPAIR CENTERS. THIS KIT INCLUDES
ALL THE SPARE PARTS SHOWN HERE UNDER

CODICE CODE	DESCRIZIONE DESCRIPTION	Q.TÀ QTY
24801	UGELLO COMPLETO COMPLETE NOZZLE	1
KR2250	KIT GUARNIZIONI COMPLETO COMPLETE GASKETS KIT	1
O003	FILTRO FILTER	1
S101	MANOMETRO ø 50 mm GAUGE ø 50 mm	1



Art. 26090 Mod. 1:1/5060 - Art. 26091 Mod. 1:1/5060
 Art. 26093 Mod. 1:1/5074 - Art. 26094 Mod. 1:1/5094



VISTA ESPLOSA - EXPLODED VIEW

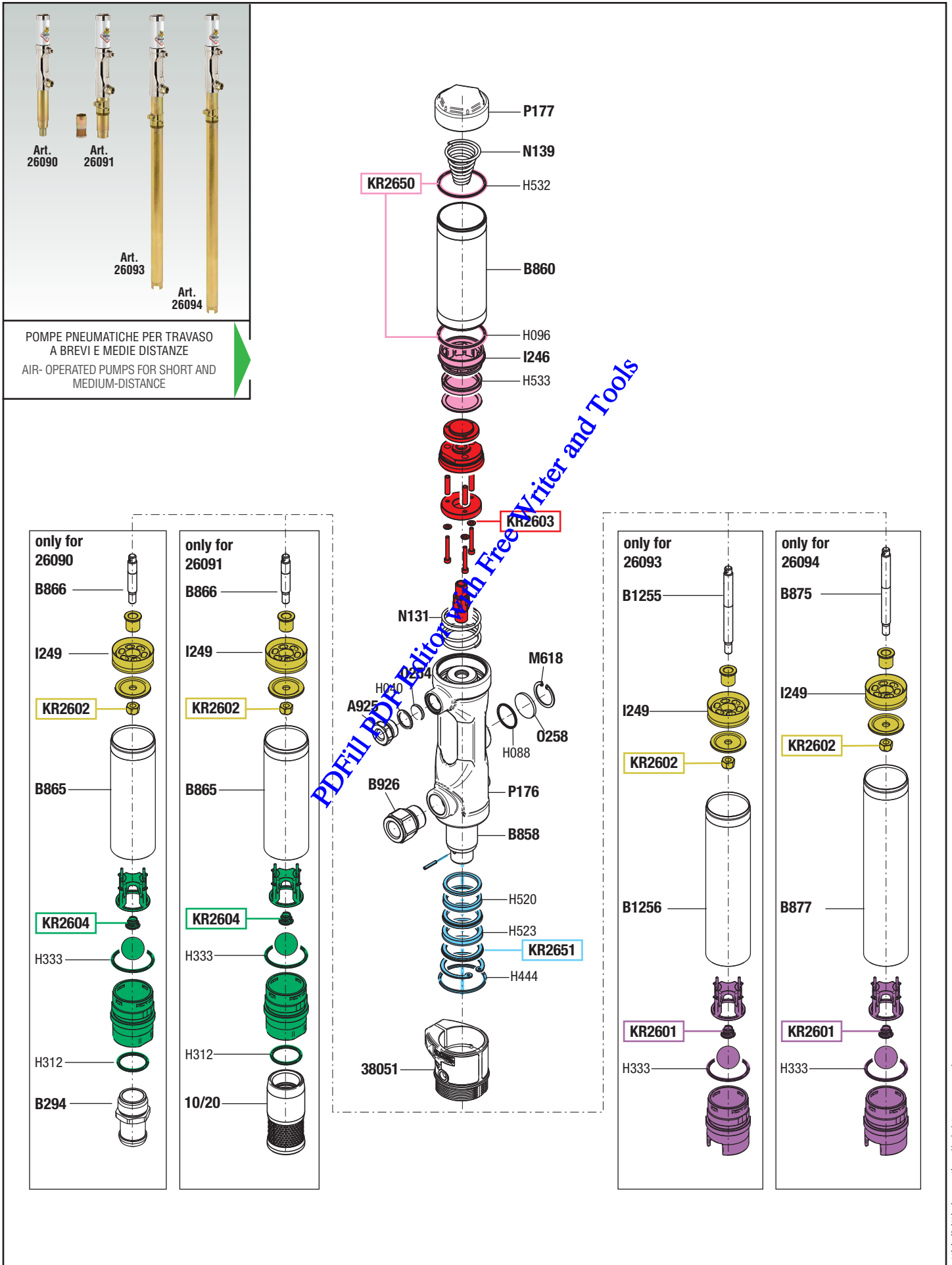

tutti i diritti riservati - all rights reserved

GUIDA RICAMBI - SPARE PARTS GUIDE

KIT RICAMBI OGNI KIT SOTTO RIPORTATO COMPRENDE I RICAMBI EVIDENZIATI CON LO STESSO COLORE E LE RELATIVE GUARNIZIONI. QUESTI RICAMBI NON SONO FORNIBILI SEPARATAMENTE TRANNE QUELLI CODIFICATI.		
SPARE PARTS KITS EACH KIT SHOWN WITH THE SAME COLOR INCLUDES ALSO THE GASKETS. THE SPARE PARTS INCLUDED IN THE KIT CAN'T BE SUPPLIED SEPARATELY EXCEPT THOSE SHOWN WITH A PROPER CODE.		
CODICE CODE	DESCRIZIONE DESCRIPTION	Q. TÀ QTY
KR2601	VALVOLA FONDO PESCANTE BOTTOM VALVE	1
KR2602	PISTONE POMPANTE PUMPING PISTON	1
KR2603	GRUPPO PISTONE MOTORE POMPANTE PUMPING MOTOR PISTON GROUP	1
KR2604	VALVOLA FONDO PESCANTE BOTTOM VALVE	1
KR2650	GRUPPO TRAVASO ARIA SLIDE VALVE GROUP	1
KR2651	PACCO GUARNIZIONI GASKETS KIT	1

ELENCO RICAMBI FORNIBILI SINGOLARMENTE LIST OF SPARE PARTS WHICH CAN BE SUPPLIED SEPARATELY		
CODICE CODE	DESCRIZIONE DESCRIPTION	Q. TÀ QTY
10/20	VALVOLA FONDO PESCANTE Art. 26091 BOTTOM VALVE Art. 26091	1
38051	GHERA PER FUSTO ø 50 mm Art. 26091 - 26094 BUNG ADAPTOR ø 50 mm Art. 26091 - 26094	1
A925	ADATTATORE M 1/2" G x F 1/4" G ADAPTOR M 1/2" G x F 1/4" G	1
B294	PORTATUBO A RESCA Art. 26090 HOSE CONNECTION Art. 26090	1
B858	PISTONE BASCULANTE PISTON	1
B860	TUBO PISTONE PISTON TUBE	1
B865	TUBO PESCANTE SUCTION TUBE	1
B866	STELO POMPANTE Art. 26090 - 26091 PUMPING ROD Art. 26090 - 26091	1
B875	STELO POMPANTE Art. 26094 PUMPING ROD Art. 26094	1
B877	TUBO PESCANTE Art. 26094 SUCTION TUBE Art. 26094	1
B926	RACCORDO CONNECTOR	1
B1255	STELO POMPANTE Art. 26093 PUMPING ROD Art. 26093	1
B1256	TUBO PESCANTE Art. 26093 SUCTION TUBE Art. 26093	1
I246	ANELLO TRAVASO ARIA SLIDE VALVE RING	1
M618	ANELLO SEEGER ø 30 mm SEEGER RING ø 30 mm	1
N131	MOLLA SPRING	1
N139	MOLLA CONICA CONIC SPRING	1
P176	CORPO POMPA PUMP BODY	1
P177	TAPPO POMPA PUMP PLUG	1

Art. KR3358 KIT GUARNIZIONI COMPLETO COMPOSTO DALLE GUARNIZIONI SOTTO ELENCAE JOINTS GASKETS LIST INCLUDING ALL THE GASKETS SHOWN HERE UNDER		
CODICE CODE	DESCRIZIONE DESCRIPTION	Q. TÀ QTY
H040	O-RING 123 O-RING 123	1
H088	O-RING 2106 "NBR 70" O-RING 2106 "NBR 70"	1
H096	O-RING 3168 O-RING 3168	1
H312	O-RING 3118 "VITON" O-RING 3118 "VITON"	1
H333	O-RING 3168 "VITON" O-RING 3168 "VITON"	1
H444	O-RING 3193 "VITON" O-RING 3193 "VITON"	1
H520	GUARNIZIONE IN "VITON" GASKET "VITON"	1
H523	GUARNIZIONE IN "VITON" GASKET "VITON"	1
H532	O-RING O-RING	1
H533	GUARNIZIONE GASKET	1
I249	PISTONE POMPANTE PUMPING PISTON	1
O254	SILENZIATORE A PASTICCA MUFFLER	1
O258	SILENZIATORE A PASTICCA MUFFLER	1

Art. KS3387 SET RICAMBI CONSIGLIATI AI PUNTI VENDITA E ASSISTENZA. COMPOSTO DAI RICAMBI SOTTO ELENCAE SPARE PARTS KIT ADVISED TO THE REPAIR CENTERS. THIS KIT INCLUDES ALL THE SPARE PARTS SHOWN HERE UNDER		
CODICE CODE	DESCRIZIONE DESCRIPTION	Q. TÀ QTY
KR2603	GRUPPO PISTONE MOTORE POMPANTE PUMPING MOTOR PISTON GROUP	1
KR3358	KIT GUARNIZIONI COMPLETO COMPLETE GASKETS KIT	1
N131	MOLLA SPRING	1
N139	MOLLA CONICA CONIC SPRING	1



Art. 30050

VISTA ESPLOSA - EXPLODED VIEW



POMPE MANUALE A
DOPPIO EFFETTO
DOUBLE-ACTING
MANUAL PUMP

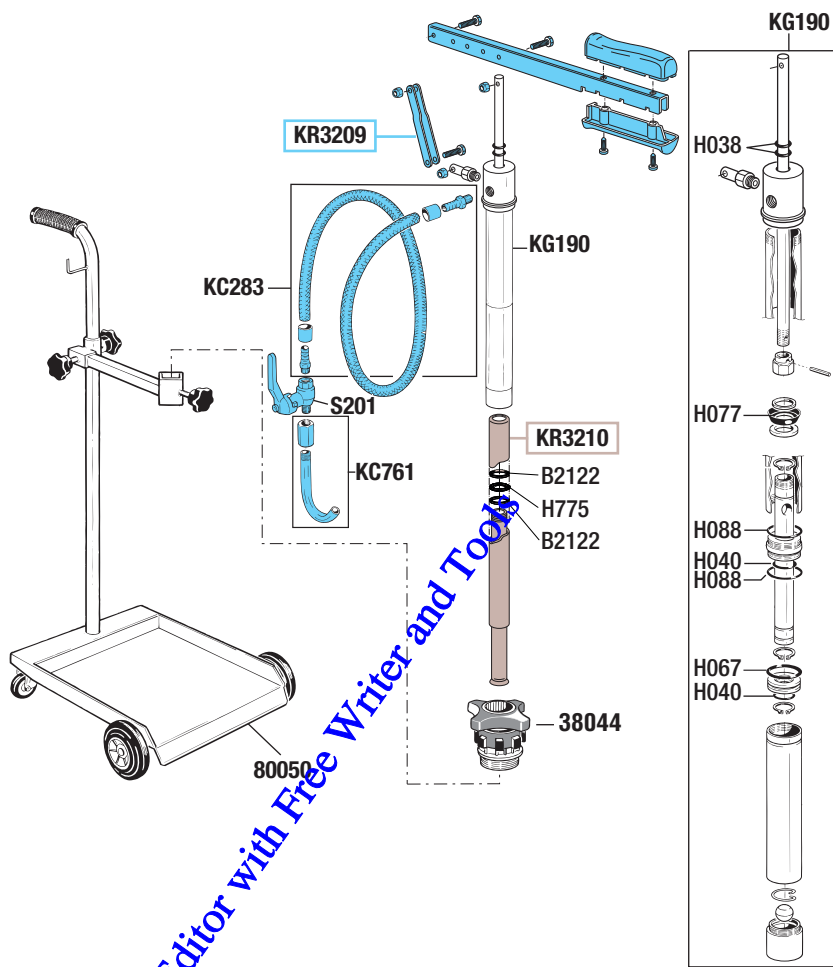

tutti i diritti riservati - all rights reserved

GUIDA RICAMBI - SPARE PARTS GUIDE

KIT RICAMBI
OGNI KIT SOTTO RIPORTATO COMPRENDE I RICAMBI EVIDENZIATI CON LO STESSO COLORE E LE RELATIVE GUARNIZIONI. QUESTI RICAMBI NON SONO FORNIBILI SEPARATAMENTE TRANNE QUELLI CODIFICATI.

SPARE PARTS KITS
EACH KIT SHOWN WITH THE SAME COLOR INCLUDES ALSO THE GASKETS. THE SPARE PARTS INCLUDED IN THE KIT CAN'T BE SUPPLIED SEPARATELY EXCEPT THOSE SHOWN WITH A PROPER CODE.

CODICE CODE	DESCRIZIONE DESCRIPTION	Q.TÀ QTY
KR3209	LEVA E TUBO DI EROGAZIONE LEVER AND DELIVERY HOSE	1
KR3210	PROLUNGA TELESCOPICA TELESCOPIC EXTENSION	1

ELENCO RICAMBI FORNIBILI SINGOLARMENTE
LIST OF SPARE PARTS WHICH CAN BE SUPPLIED SEPARATELY

CODICE CODE	DESCRIZIONE DESCRIPTION	Q.TÀ QTY
38044	GHIERA DI BLOCCAGGIO ø 38 mm BUNG ADAPTOR ø 38 mm	1
80050	CARRELLO PER CONTENITORI DA 20 - 60 Kg TROLLEY FOR CONTAINERS 20 - 60 Kg	1
KC283	TUBO COLLEGAMENTO CONNECTING HOSE	1
KC761	TERMINALE TERMINAL	1
KG190	POMPA OLIO MANUALE MANUAL PUMP GROUP	1
S201	RUBINETTO A SFERA 1/4" BALL VALVE 1/4"	1

Art. KR3250
KIT GUARNIZIONI COMPLETO
COMPOSTO DALLE GUARNIZIONI SOTTO ELENCAE
JOINTS GASKETS LIST
INCLUDING ALL THE GASKETS SHOWN HERE UNDER

CODICE CODE	DESCRIZIONE DESCRIPTION	Q.TÀ QTY
B2122	RONDELLA TENUTA O-RING O-RING SEALING WASHER	2
H038	O-RING 115 O-RING 115	1
H040	O-RING 123 O-RING 123	1
H067	O-RING 4112 O-RING 4112	1
H068	O-RING 112 O-RING 112	1
H077	GUARNIZIONE GASKET	1
H088	O-RING 2106 "NBR 70" O-RING 2106 "NBR 70"	2
H775	O-RING "VITON" O-RING "VITON"	1

IL KIT GUARNIZIONI KR3250 E' ADATTO ANCHE PER LA PRECEDENTE VERSIONE DELLA POMPA (KG170)

THE GASKETS KIT KR3250 IS SUITABLE FOR THE PREVIOUS VERSION OF THE PUMP (KG170)

Art. KS3280
SET RICAMBI CONSIGLIATI
AI PUNTI VENDITA E ASSISTENZA,
COMPOSTO DAI RICAMBI SOTTO ELENCAE
SPARE PARTS KIT ADVISED
TO THE REPAIR CENTERS. THIS KIT INCLUDES
ALL THE SPARE PARTS SHOWN HERE UNDER

CODICE CODE	DESCRIZIONE DESCRIPTION	Q.TÀ QTY
KR3209	LEVA E TUBO DI EROGAZIONE LEVER AND DELIVERY HOSE	1
KR3250	KIT GUARNIZIONI COMPLETO COMPLETE GASKETS KIT	1



Art. 30051

VISTA ESPLOSA - EXPLODED VIEW

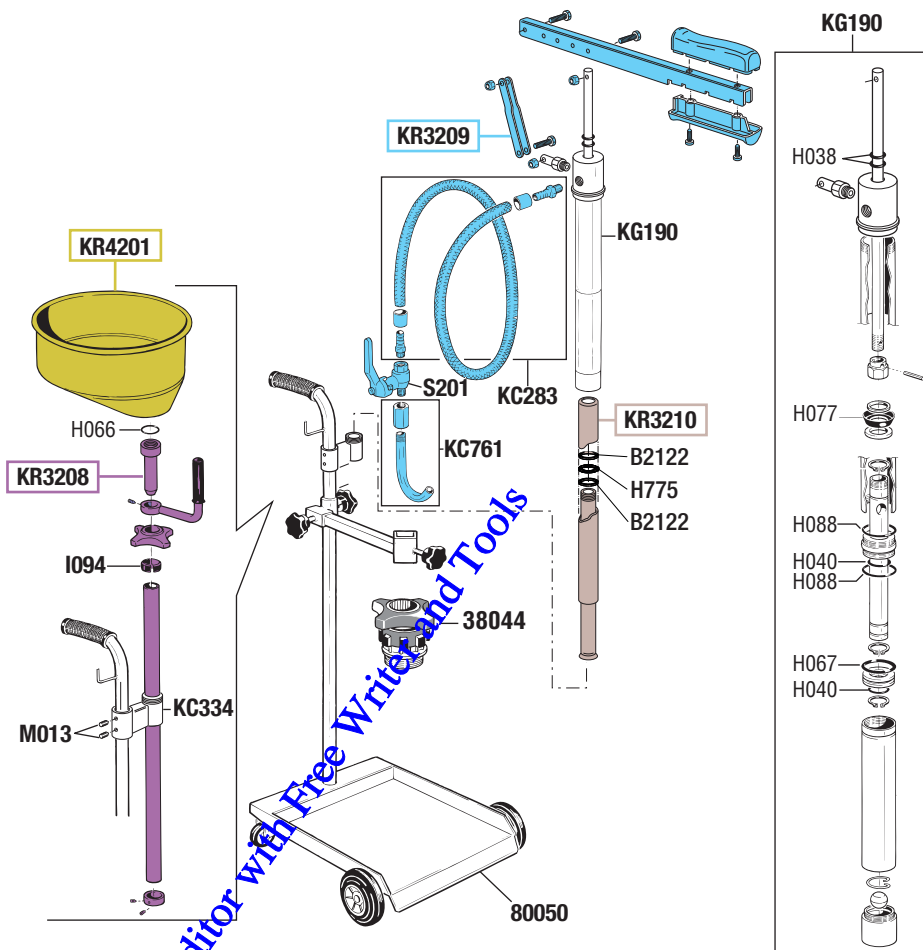

tutti i diritti riservati - all rights reserved

GUIDA RICAMBI - SPARE PARTS GUIDE

KIT RICAMBI
OGNI KIT SOTTO RIPORTATO COMPRENDE I RICAMBI EVIDENZIATI CON LO STESSO COLORE E LE RELATIVE GUARNIZIONI. QUESTI RICAMBI NON SONO FORNIBILI SEPARATAMENTE TRANNE QUELLI CODIFICATI.

SPARE PARTS KITS
EACH KIT SHOWN WITH THE SAME COLOR INCLUDES ALSO THE GASKETS. THE SPARE PARTS INCLUDED IN THE KIT CAN'T BE SUPPLIED SEPARATELY EXCEPT THOSE SHOWN WITH A PROPER CODE.

CODICE CODE	DESCRIZIONE DESCRIPTION	Q.TÀ QTY
KR3208	GRUPPO SUPPORTO COPPA BOWL SUPPORT UNIT	1
KR3209	LEVA E TUBO DI EROGAZIONE LEVER AND DELIVERY HOSE	1
KR3210	PROLUNGA TELESCOPICA TELESCOPIC EXTENSION	1
KR4201	COPPA RACCOGLI OLIO OIL COLLECTING BOWL	1

ELENCO RICAMBI FORNIBILI SINGOLARMENTE
LIST OF SPARE PARTS WHICH CAN BE SUPPLIED SEPARATELY

CODICE CODE	DESCRIZIONE DESCRIPTION	Q.TÀ QTY
38044	GHIERA DI BLOCCAGGIO ø 38 mm BUNG ADAPTOR ø 38 mm	1
80050	CARRELLO PER CONTENITORI DA 20 - 60 Kg TROLLEY FOR CONTAINERS 20 - 60 Kg	1
I094	OGIVA STRINGI TUBO CLAMPING TUBE OGIVE	1
KC283	TUBO COLLEGAMENTO CONNECTING HOSE	1
KC334	STAFFA SUPPORTO SUPPORT BRACKET	1
KC761	TERMINALE TERMINAL	1
KG190	POMPA OLIO MANUALE MANUAL PUMP GROUP	1
M013	GRANO GRUB SCREW	1
S201	RUBINETTO A SFERA 1/4" BALL VALVE 1/4"	1

Art. KR3250
KIT GUARNIZIONI COMPLETO
COMPOSTO DALLE GUARNIZIONI SOTTO ELENCAE JOINTS GASKETS LIST INCLUDING ALL THE GASKETS SHOWN HERE UNDER

CODICE CODE	DESCRIZIONE DESCRIPTION	Q.TÀ QTY
B2122	RONDELLA TENUTA O-RING O-RING SEALING WASHER	2
H038	O-RING 115 O-RING 115	1
H040	O-RING 123 O-RING 123	1
H067	O-RING 4112 O-RING 4112	1
H068	O-RING 112 O-RING 112	1
H077	GUARNIZIONE GASKET	1
H088	O-RING 2106 "NBR 70" O-RING 2106 "NBR 70"	2
H775	O-RING "NBR" O-RING "NBR"	1

IL KIT GUARNIZIONI KR3250 E' ADATTO ANCHE PER LA PRECEDENTE VERSIONE DELLA POMPA (KG170)

THE GASKETS KIT KR3250 IS SUITABLE FOR THE PREVIOUS VERSION OF THE PUMP (KG170)

Art. KS3280
SET RICAMBI CONSIGLIATI
AI PUNTI VENDITA E ASSISTENZA, COMPOSTO DAI RICAMBI SOTTO ELENCAE
SPARE PARTS KIT ADVISED
TO THE REPAIR CENTERS. THIS KIT INCLUDES ALL THE SPARE PARTS SHOWN HERE UNDER

CODICE CODE	DESCRIZIONE DESCRIPTION	Q.TÀ QTY
KR3209	LEVA E TUBO DI EROGAZIONE LEVER AND DELIVERY HOSE	1
KR3250	KIT GUARNIZIONI COMPLETO COMPLETE GASKETS KIT	1



Art. 30200

VISTA ESPLOSA - EXPLODED VIEW



POMPE MANUALE A DOPPIO EFFETTO
DOUBLE-ACTING MANUAL PUMP

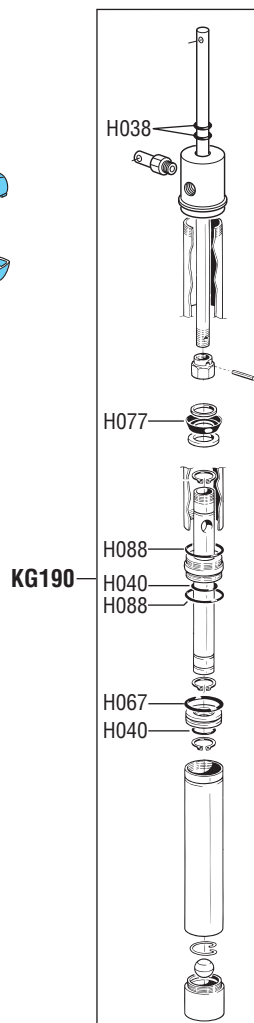
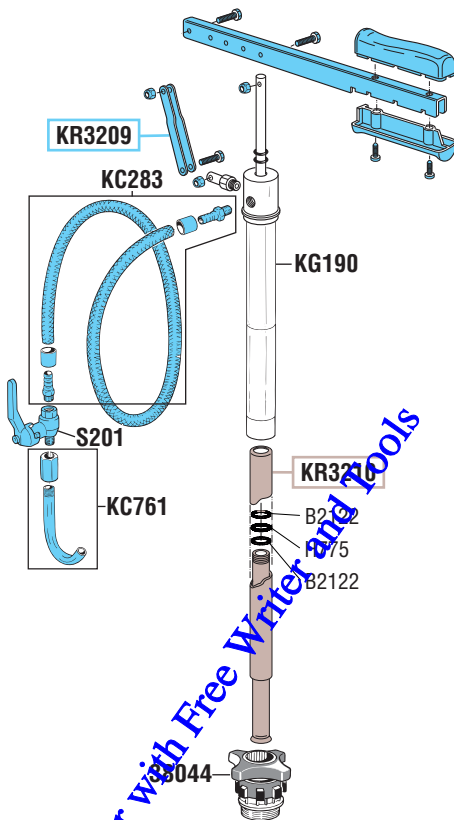

GUIDA RICAMBI - SPARE PARTS GUIDE

KIT RICAMBI
OGNI KIT SOTTO RIPORTATO COMPRENDE I RICAMBI EVIDENZIATI CON LO STESSO COLORE E LE RELATIVE GUARNIZIONI. QUESTI RICAMBI NON SONO FORNIBILI SEPARATAMENTE TRANNE QUELLI CODIFICATI.

SPARE PARTS KITS
EACH KIT SHOWN WITH THE SAME COLOR INCLUDES ALSO THE GASKETS. THE SPARE PARTS INCLUDED IN THE KIT CAN'T BE SUPPLIED SEPARATELY EXCEPT THOSE SHOWN WITH A PROPER CODE.

CODICE CODE	DESCRIZIONE DESCRIPTION	Q.TÀ QTY
KR3209	LEVA E TUBO DI EROGAZIONE LEVER AND DELIVERY HOSE	1
KR3210	PROLUNGA TELESCOPICA TELESCOPIC EXTENSION	1

ELENCO RICAMBI FORNIBILI SINGOLARMENTE
LIST OF SPARE PARTS WHICH CAN BE SUPPLIED SEPARATELY

CODICE CODE	DESCRIZIONE DESCRIPTION	Q.TÀ QTY
38044	GHIERA DI BLOCCAGGIO ø 38 mm BUNG ADAPTOR ø 38 mm	1
KC283	TUBO COLLEGAMENTO CONNECTING HOSE	1
KC761	TERMINALE TERMINAL	1
KG190	POMPA OLIO MANUALE MANUAL PUMP GROUP	1
S201	RUBINETTO A SFERA 1/4" BALL VALVE 1/4"	1

Art. KR3250
KIT GUARNIZIONI COMPLETO
COMPOSTO DALLE GUARNIZIONI SOTTO ELENCAE
JOINTS GASKETS LIST
INCLUDING ALL THE GASKETS SHOWN HERE UNDER

CODICE CODE	DESCRIZIONE DESCRIPTION	Q.TÀ QTY
B2122	RONDELLA TENUTA O-RING O-RING SEALING WASHER	2
H038	O-RING 115 O-RING 115	2
H040	O-RING 123 O-RING 123	2
H067	O-RING 4112 O-RING 4112	2
H068	O-RING 112 O-RING 112	1
H077	GUARNIZIONE GASKET	1
H088	O-RING 2106 "NBR 70" O-RING 2106 "NBR 70"	2
H775	O-RING "NBR" O-RING "NBR"	1

IL KIT GUARNIZIONI KR3250 E' ADATTO ANCHE PER LA PRECEDENTE VERSIONE DELLA POMPA (KG170)

THE GASKETS KIT KR3250 IS SUITABLE FOR THE PREVIOUS VERSION OF THE PUMP (KG170)

Art. KS3280
SET RICAMBI CONSIGLIATI
AI PUNTI VENDITA E ASSISTENZA,
COMPOSTO DAI RICAMBI SOTTO ELENCAE
SPARE PARTS KIT ADVISED
TO THE REPAIR CENTERS. THIS KIT INCLUDES
ALL THE SPARE PARTS SHOWN HERE UNDER

CODICE CODE	DESCRIZIONE DESCRIPTION	Q.TÀ QTY
KR3209	LEVA E TUBO DI EROGAZIONE LEVER AND DELIVERY HOSE	1
KR3250	KIT GUARNIZIONI COMPLETO COMPLETE GASKETS KIT	1

tutti i diritti riservati - all rights reserved



Art. 31200



VISTA ESPLOSA - EXPLODED VIEW

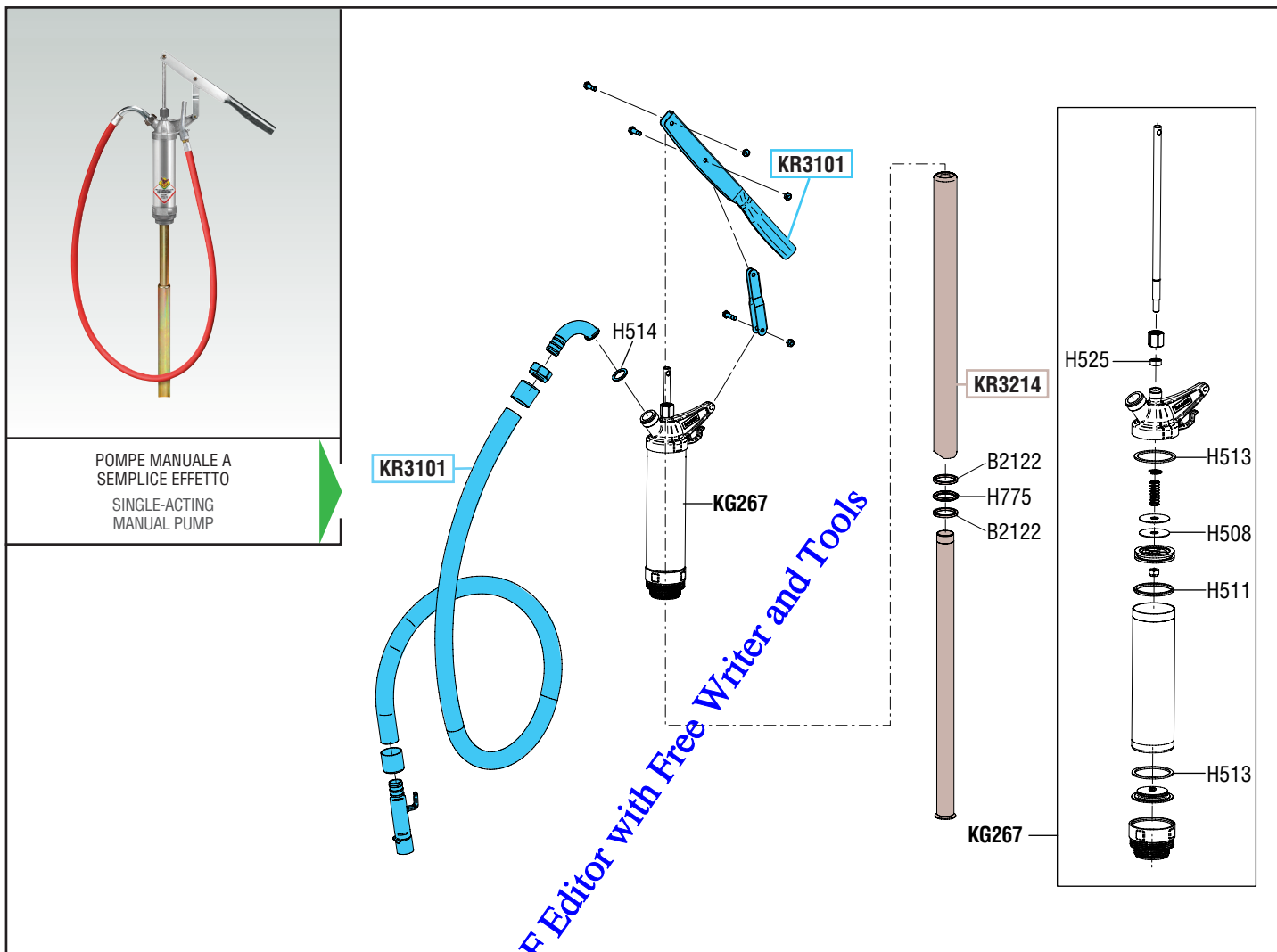

POMPE MANUALE A
SEMPLICE EFFETTO
SINGLE-ACTING
MANUAL PUMP

KR3101

H514

KR3101

PDF Editor with Free Writer and Tools

KG267

KR3214

B2122

H775

B2122

KG267

H525

H513

H508

H511

H513

tutti i diritti riservati - all rights reserved

GUIDA RICAMBI - SPARE PARTS GUIDE

KIT RICAMBI
OGNI KIT SOTTO RIPORTATO COMPRENDE I RICAMBI EVIDENZIATI CON LO STESSO COLORE E LE RELATIVE GUARNIZIONI. QUESTI RICAMBI NON SONO FORNIBILI SEPARATAMENTE TRANNE QUELLI CODIFICATI.

SPARE PARTS KITS
EACH KIT SHOWN WITH THE SAME COLOR INCLUDES ALSO THE GASKETS. THE SPARE PARTS INCLUDED IN THE KIT CAN'T BE SUPPLIED SEPARATELY EXCEPT THOSE SHOWN WITH A PROPER CODE.

CODICE CODE	DESCRIZIONE DESCRIPTION	Q.TÀ QTY
KR3101	TERMINALE FLESSIBILE E LEVA FLEXIBLE TERMINAL AND LEVER	1
KR3214	PROLUNGA TELESCOPICA TELESCOPIC EXTENSION	1

ELENCO RICAMBI FORNIBILI SINGOLARMENTE
LIST OF SPARE PARTS WHICH CAN BE SUPPLIED SEPARATELY

CODICE CODE	DESCRIZIONE DESCRIPTION	Q.TÀ QTY
KG267	GRUPPO POMPA MANUALE MANUAL PUMP KIT	1

Art. KR3150 **KIT GUARNIZIONI COMPLETO**
COMPOSTO DALLE GUARNIZIONI SOTTO ELENCAE
JOINTS GASKETS LIST
INCLUDING ALL THE GASKETS SHOWN HERE UNDER

CODICE CODE	DESCRIZIONE DESCRIPTION	Q.TÀ QTY
B2122	RONDELLA TENUTA O-RING O-RING SEALING WASHER	2
H508	ANELLO VALVOLA PISTONE PISTON VALVE RING	1
H511	O-RING "VITON" O-RING "VITON"	1
H513	O-RING "POLIETILENE" O-RING "POLYETHYLENE"	2
H514	O-RING "POLIETILENE" O-RING "POLYETHYLENE"	1
H525	GUARNIZIONE GASKET	1
H775	O-RING "NBR" O-RING "NBR"	1

Art. KS3282 **SET RICAMBI CONSIGLIATI**
AI PUNTI VENDITA E ASSISTENZA,
COMPOSTO DAI RICAMBI SOTTO ELENCAE
SPARE PARTS KIT ADVISED
TO THE REPAIR CENTERS. THIS KIT INCLUDES
ALL THE SPARE PARTS SHOWN HERE UNDER

CODICE CODE	DESCRIZIONE DESCRIPTION	Q.TÀ QTY
KR3101	TERMINALE FLESSIBILE E LEVA FLEXIBLE TERMINAL AND LEVER	1
KR3150	KIT GUARNIZIONI COMPLETO COMPLETE GASKETS KIT	1



Art. 31201



VISTA ESPLOSA - EXPLODED VIEW



POMPE MANUALE A SEMPLICE EFFETTO
SINGLE-ACTING
MANUAL PUMP

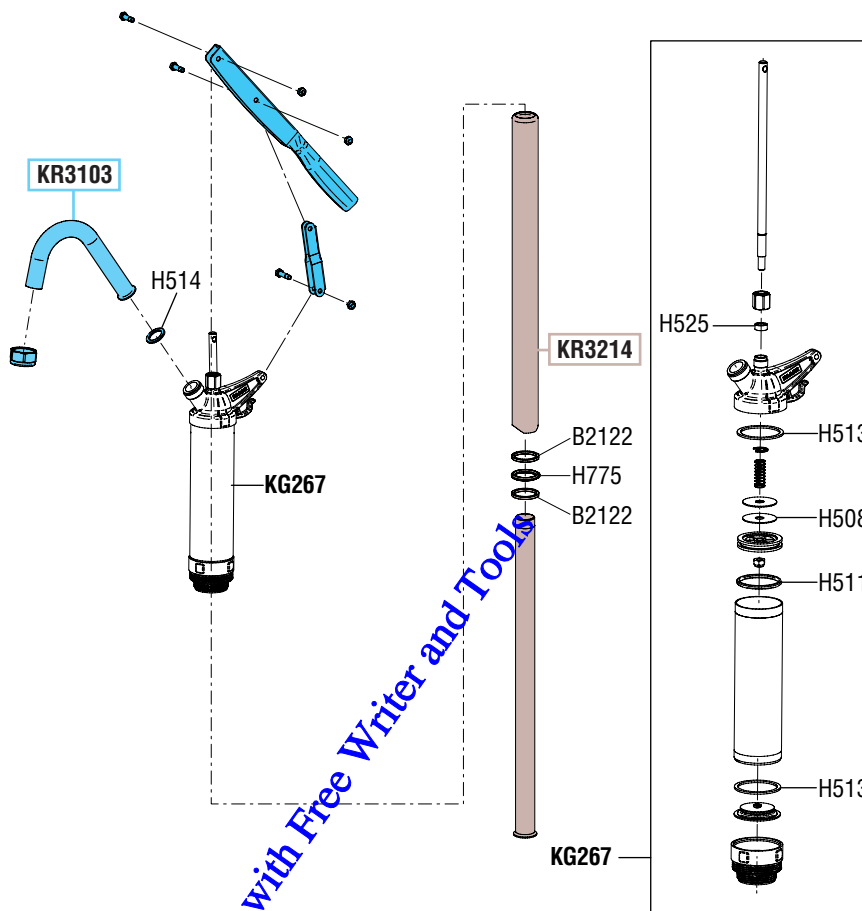

GUIDA RICAMBI - SPARE PARTS GUIDE

KIT RICAMBI
OGNI KIT SOTTO RIPORTATO COMPRENDE I RICAMBI EVIDENZIATI CON LO STESSO COLORE E LE RELATIVE GUARNIZIONI. QUESTI RICAMBI NON SONO FORNIBILI SEPARATAMENTE TRANNE QUELLI CODIFICATI.

SPARE PARTS KITS
EACH KIT SHOWN WITH THE SAME COLOR INCLUDES ALSO THE GASKETS. THE SPARE PARTS INCLUDED IN THE KIT CAN'T BE SUPPLIED SEPARATELY EXCEPT THOSE SHOWN WITH A PROPER CODE.

CODICE CODE	DESCRIZIONE DESCRIPTION	Q.TÀ QTY
KR3103	TERMINALE RIGIDO E LEVA RIGID TERMINAL AND LEVER	1
KR3214	PROLUNGA TELESCOPICA TELESCOPIC EXTENSION	1

ELENCO RICAMBI FORNIBILI SINGOLARMENTE
LIST OF SPARE PARTS WHICH CAN BE SUPPLIED SEPARATELY

CODICE CODE	DESCRIZIONE DESCRIPTION	Q.TÀ QTY
KG267	GRUPPO POMPA MANUALE MANUAL PUMP KIT	1

Art. KR3150
KIT GUARNIZIONI COMPLETO
COMPOSTO DALLE GUARNIZIONI SOTTO ELENCAE
JOINTS GASKETS LIST
INCLUDING ALL THE GASKETS SHOWN HERE UNDER

CODICE CODE	DESCRIZIONE DESCRIPTION	Q.TÀ QTY
B2122	RONDELLA TENUTA O-RING O-RING SEALING WASHER	2
H775	O-RING "NBR" O-RING "NBR"	1
H508	ANELLO VALVOLA PISTONE PISTON VALVE RING	1
H511	O-RING "VITON" O-RING "VITON"	1
H513	O-RING "POLIETILENE" O-RING "POLYETHYLENE"	2
H514	O-RING "POLIETILENE" O-RING "POLYETHYLENE"	1
H525	GUARNIZIONE GASKET	1

Art. KS3283
SET RICAMBI CONSIGLIATI
AI PUNTI VENDITA E ASSISTENZA,
COMPOSTO DAI RICAMBI SOTTO ELENCAE
SPARE PARTS KIT ADVISED
TO THE REPAIR CENTERS. THIS KIT INCLUDES
ALL THE SPARE PARTS SHOWN HERE UNDER

CODICE CODE	DESCRIZIONE DESCRIPTION	Q.TÀ QTY
KR3103	TERMINALE RIGIDO E LEVA RIGID TERMINAL AND LEVER	1
KR3150	GUARNIZIONI COMPLETO COMPLETE GASKETS KIT	1

tutti i diritti riservati - all rights reserved



Art. 32016 Mod. DO.M. 16L



VISTA ESPLOSA - EXPLODED VIEW



DISTRIBUTORE D'OLIO MANUALE CON SERBATOIO PORTATILE DA 16 l
PORTABLE MANUAL OIL DISPENSER WITH 16 l TANK

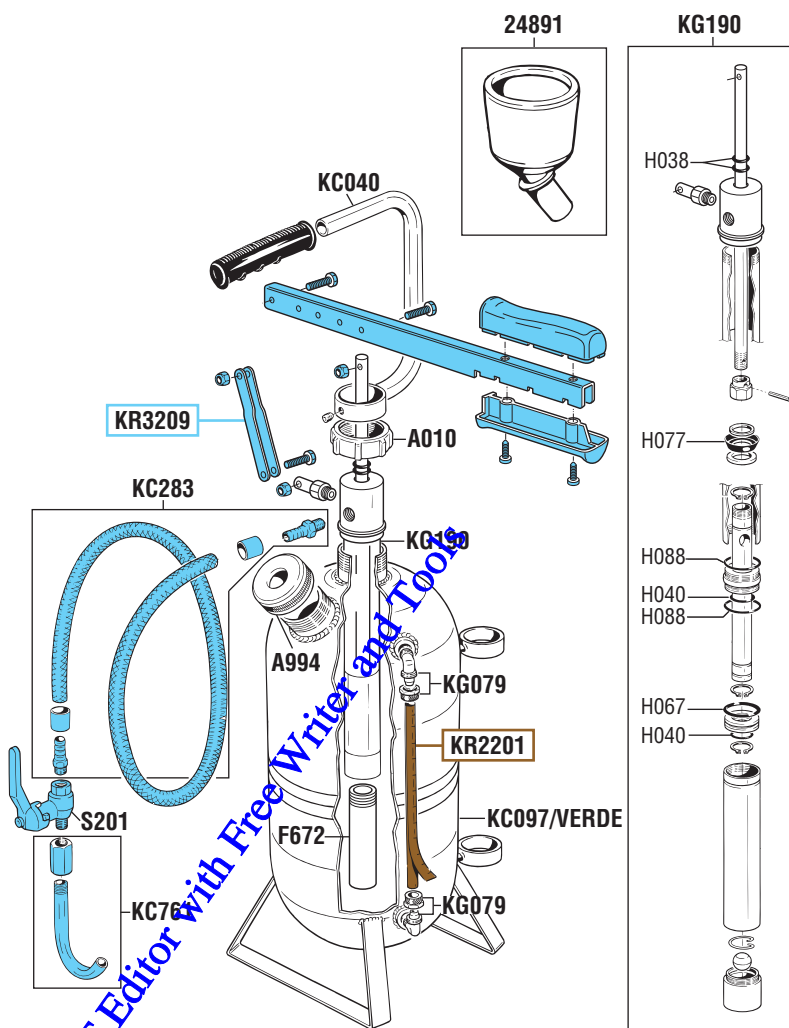

tutti i diritti riservati - all rights reserved

GUIDA RICAMBI - SPARE PARTS GUIDE

KIT RICAMBI
OGNI KIT SOTTO RIPORTATO COMPRENDE I RICAMBI EVIDENZIATI CON LO STESSO COLORE E LE RELATIVE GUARNIZIONI. QUESTI RICAMBI NON SONO FORNIBILI SEPARATAMENTE TRANNE QUELLI CODIFICATI.

SPARE PARTS KITS
EACH KIT SHOWN WITH THE SAME COLOR INCLUDES ALSO THE GASKETS. THE SPARE PARTS INCLUDED IN THE KIT CAN'T BE SUPPLIED SEPARATELY EXCEPT THOSE SHOWN WITH A PROPER CODE.

CODICE CODE	DESCRIZIONE DESCRIPTION	Q.TÀ QTY
KR2201	TUBO DI LIVELLO ED ETICHETTA GAUGE TUBE AND LABEL	1
KR3209	LEVA E TUBO DI EROGAZIONE LEVER AND DELIVERY HOSE	1

ELENCO RICAMBI FORNIBILI SINGOLARMENTE
LIST OF SPARE PARTS WHICH CAN BE SUPPLIED SEPARATELY

CODICE CODE	DESCRIZIONE DESCRIPTION	Q.TÀ QTY
24891	IMBUTO FUNNEL	1
A010	GHIERA UNIVERSALE UNIVERSAL RING	1
A994	TAPPO BASSA PRESSIONE LOW PRESSURE PLUG	1
F672	PROLUNGA 115 mm EXTENSION 115 mm	1
KC040	MANICO A "C" HANDLE	1
KC097/VERDE	SERBATOIO 16 l RESERVOIR 16 l	1
KC283	TUBO COLLEGAMENTO CONNECTING HOSE	1
KC761	TERMINALE TERMINAL	1
KG079	GRUPPO GOMITO E GHIERA RING AND ELBOW JOINT GROUP	2
KG190	POMPA OLIO MANUALE MANUAL PUMP GROUP	1
S201	RUBINETTO A SFERA 1/4" BALL VALVE 1/4"	1

Art. KR3251 **KIT GUARNIZIONI COMPLETO**
COMPOSTO DALLE GUARNIZIONI SOTTO ELENCAE
JOINTS GASKETS LIST
INCLUDING ALL THE GASKETS SHOWN HERE UNDER

CODICE CODE	DESCRIZIONE DESCRIPTION	Q.TÀ QTY
H037	O-RING 3137 O-RING 3137	2
H038	O-RING 115 O-RING 115	2
H040	O-RING 123 O-RING 123	2
H067	O-RING 4112 O-RING 4112	1
H077	GUARNIZIONE GASKET	1
H088	O-RING 2106 "NBR 70" O-RING 2106 "NBR 70"	2

Art. KS3281 **SET RICAMBI CONSIGLIATI**
AI PUNTI VENDITA E ASSISTENZA,
COMPOSTO DAI RICAMBI SOTTO ELENCAE
SPARE PARTS KIT ADVISED
TO THE REPAIR CENTERS. THIS KIT INCLUDES
ALL THE SPARE PARTS SHOWN HERE UNDER

CODICE CODE	DESCRIZIONE DESCRIPTION	Q.TÀ QTY
KR3209	LEVA E TUBO DI EROGAZIONE LEVER AND DELIVERY HOSE	1
KR3251	KIT GUARNIZIONI COMPLETO COMPLETE GASKETS KIT	1



Art. 32024 Mod. DO.M. 24L

VISTA ESPLOSA - EXPLODED VIEW

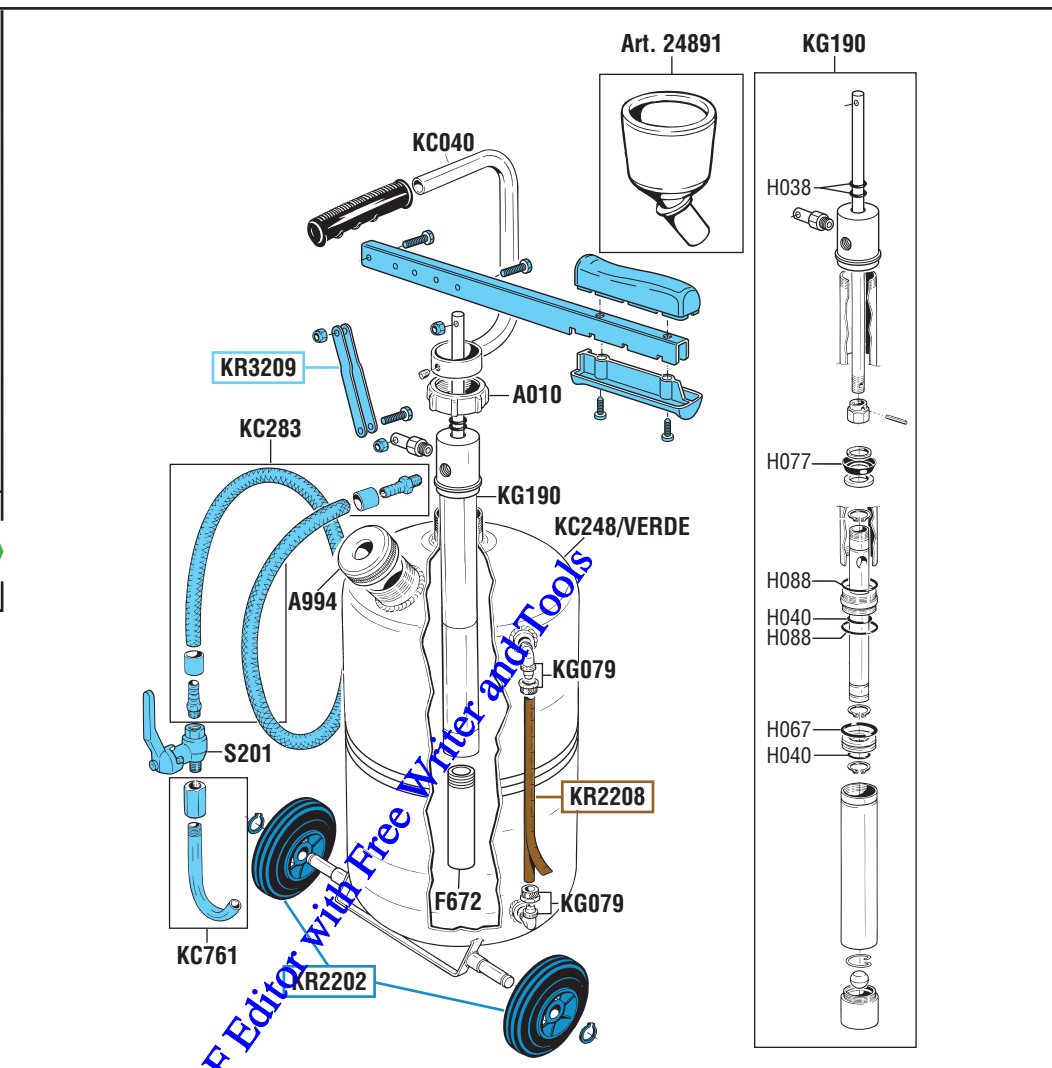

GUIDA RICAMBI - SPARE PARTS GUIDE

KIT RICAMBI
OGNI KIT SOTTO RIPORTATO COMPRENDE I RICAMBI EVIDENZIATI CON LO STESSO COLORE E LE RELATIVE GUARNIZIONI. QUESTI RICAMBI NON SONO FORNIBILI SEPARATAMENTE TRANNE QUELLI CODIFICATI.

SPARE PARTS KITS
EACH KIT SHOWN WITH THE SAME COLOR INCLUDES ALSO THE GASKETS. THE SPARE PARTS INCLUDED IN THE KIT CAN'T BE SUPPLIED SEPARATELY EXCEPT THOSE SHOWN WITH A PROPER CODE.

CODICE CODE	DESCRIZIONE DESCRIPTION	Q.TÀ QTY
KR2202	DUE RUOTE FISSE CON ANELLI ELASTICI TWO FIXED WHEELS WITH RETAINING RINGS	1
KR2208	TUBO DI LIVELLO CON ETICHETTA GAUGE TUBE WITH LABEL	1
KR3209	LEVA E TUBO DI EROGAZIONE LEVER AND DELIVERY HOSE	1

ELENCO RICAMBI FORNIBILI SINGOLARMENTE
LIST OF SPARE PARTS WHICH CAN BE SUPPLIED SEPARATELY

CODICE CODE	DESCRIZIONE DESCRIPTION	Q.TÀ QTY
24891	IMBUTO FUNNEL	1
A010	GHIERA UNIVERSALE UNIVERSAL RING	1
A994	TAPPO BASSA PRESSIONE LOW PRESSURE PLUG	1
F672	PROLUNGA 115 mm EXTENSION 115 mm	1
KC040	MANICO A "C" HANDLE	1
KC248/VERDE	SERBATOIO 24 l RESERVOIR 24 l	1
KC283	TUBO COLLEGAMENTO CONNECTING HOSE	1
KC761	TERMINALE TERMINAL	1
KG079	GRUPPO GOMITO E GHIERA RING AND ELBOW JOINT GROUP	2
KG190	POMPA OLIO MANUALE MANUAL PUMP GROUP	1
S201	RUBINETTO A SFERA 1/4" BALL VALVE 1/4"	1

Art. KR3251
KIT GUARNIZIONI COMPLETO
COMPOSTO DALLE GUARNIZIONI SOTTO ELENCAE
JOINTS GASKETS LIST
INCLUDING ALL THE GASKETS SHOWN HERE UNDER

CODICE CODE	DESCRIZIONE DESCRIPTION	Q.TÀ QTY
H037	O-RING 3137 O-RING 3137	1
H038	O-RING 115 O-RING 115	2
H040	O-RING 123 O-RING 123	2
H067	O-RING 4112 O-RING 4112	1
H077	GUARNIZIONE GASKET	1
H088	O-RING 2106 "NBR 70" O-RING 2106 "NBR 70"	2

Art. KS3281
SET RICAMBI CONSIGLIATI
AI PUNTI VENDITA E ASSISTENZA,
COMPOSTO DAI RICAMBI SOTTO ELENCAE
SPARE PARTS KIT ADVISED
TO THE REPAIR CENTERS. THIS KIT INCLUDES
ALL THE SPARE PARTS SHOWN HERE UNDER

CODICE CODE	DESCRIZIONE DESCRIPTION	Q.TÀ QTY
KR3209	LEVA E TUBO DI EROGAZIONE LEVER AND DELIVERY HOSE	1
KR3251	KIT GUARNIZIONI COMPLETO COMPLETE GASKETS KIT	1

tutti i diritti riservati - all rights reserved



Art. 32065 Mod. DO.M. 65L

VISTA ESPLOSA - EXPLODED VIEW

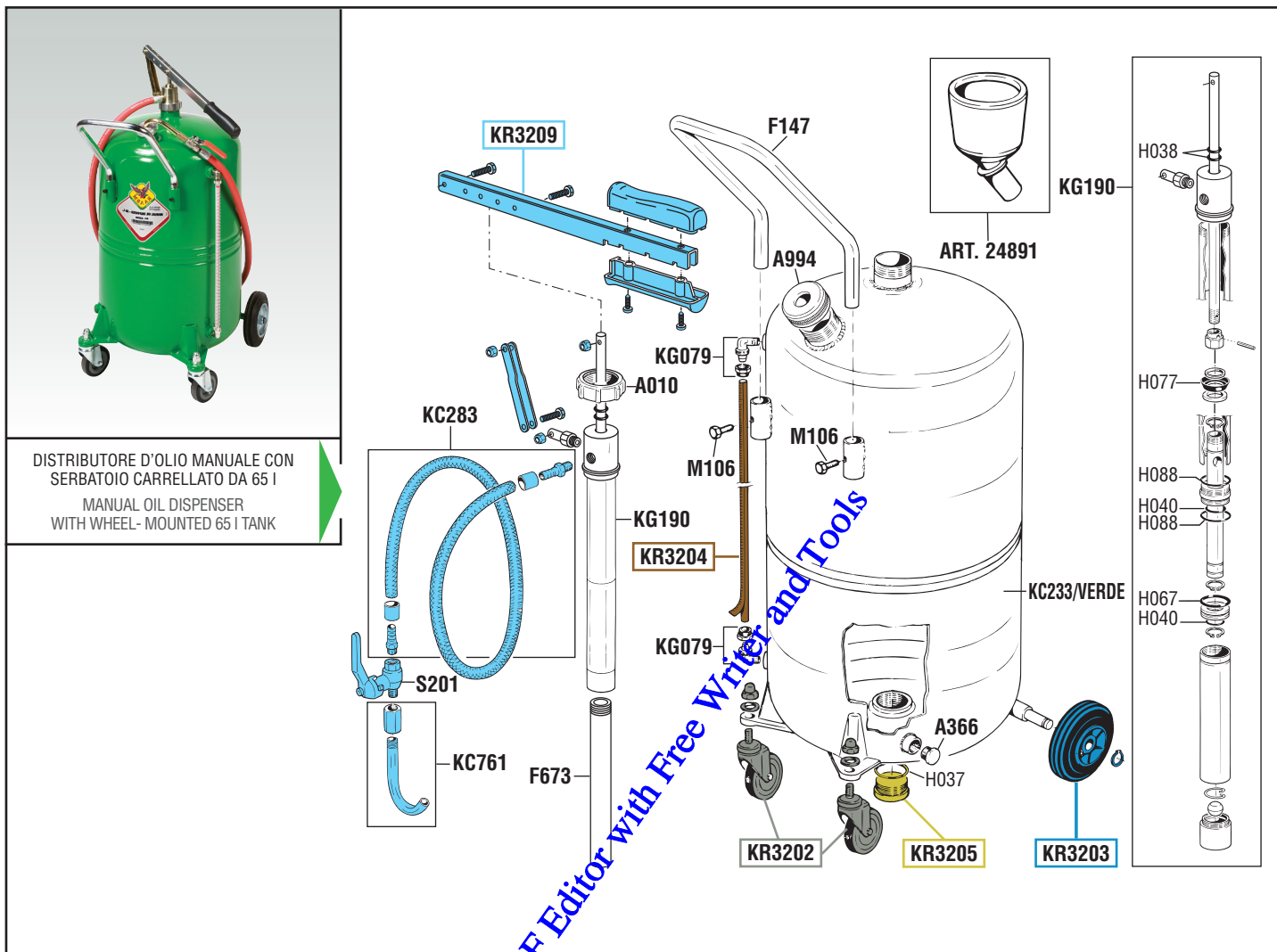

DISTRIBUTORE D'OLIO MANUALE CON SERBATOIO CARRELLATO DA 65 l
MANUAL OIL DISPENSER WITH WHEEL - MOUNTED 65 l TANK

tutti i diritti riservati - all rights reserved

GUIDA RICAMBI - SPARE PARTS GUIDE

KIT RICAMBI
OGNI KIT SOTTO RIPORTATO COMPRENDE I RICAMBI EVIDENZIATI CON LO STESSO COLORE E LE RELATIVE GUARNIZIONI. QUESTI RICAMBI NON SONO FORNIBILI SEPARATAMENTE TRANNE QUELLI CODIFICATI.
SPARE PARTS KITS
EACH KIT SHOWN WITH THE SAME COLOR INCLUDES ALSO THE GASKETS. THE SPARE PARTS INCLUDED IN THE KIT CAN'T BE SUPPLIED SEPARATELY EXCEPT THOSE SHOWN WITH A PROPER CODE.

CODICE CODE	DESCRIZIONE DESCRIPTION	Q.TÀ QTY
KR3202	DUE RUOTE PIROETTANTI CON DADI TWO SWIVELLING WHEELS WITH NUTS	1
KR3203	2 RUOTE Fisse CON ANELLI ELASTICI 2 FIXED WHEELS WITH RETAININGS RINGS	1
KR3204	TUBO DI LIVELLO ED ETICHETTA GAUGE TUBE AND LABEL	1
KR3205	TAPPO DI SCARICO DISCHARGING PLUG	1
KR3209	LEVA E TUBO DI EROGAZIONE LEVER AND DELIVERY HOSE	1

ELENCO RICAMBI FORNIBILI SINGOLARMENTE
LIST OF SPARE PARTS WHICH CAN BE SUPPLIED SEPARATELY

CODICE CODE	DESCRIZIONE DESCRIPTION	Q.TÀ QTY
24891	IMBUTO FUNNEL	1
A010	GHIERA UNIVERSALE UNIVERSAL RING	1
A382	ALBERO INFERIORE LOWER SPINDLE	1
A994	TAPPO BASSA PRESSIONE LOW PRESSURE PLUG	1
F147	MANICO A "U" HANDLE	1
F673	PROLUNGA 250 mm EXTENSION 250 mm	1
KC233/VERDE	SERBATOIO 65 l RESERVOIR 65 l	1
KC283	TUBO COLLEGAMENTO CONNECTING HOSE	1
KC761	TERMINALE TERMINAL	1
KG079	GRUPPO GOMITO E GHIERA RING AND ELBOW JOINT GROUP	2
KG190	POMPA OLIO MANUALE MANUAL PUMP GROUP	1
M106	VITE M6 x 8 SCREW M6 x 8	2
S201	RUBINETTO A SFERA 1/4" BALL VALVE 1/4"	1

Art. KR3251 KIT GUARNIZIONI COMPLETO
COMPOSTO DALLE GUARNIZIONI SOTTO ELENCAE
JOINTS GASKETS LIST INCLUDING ALL THE GASKETS SHOWN HERE UNDER

CODICE CODE	DESCRIZIONE DESCRIPTION	Q.TÀ QTY
H037	O-RING 3137 O-RING 3137	1
H038	O-RING 115 O-RING 115	2
H040	O-RING 123 O-RING 123	2
H067	O-RING 4112 O-RING 4112	1
H077	GUARNIZIONE GASKET	1
H088	O-RING 2106 "NBR 70" O-RING 2106 "NBR 70"	2

Art. KS3281 SET RICAMBI CONSIGLIATI
AI PUNTI VENDITA E ASSISTENZA,
COMPOSTO DAI RICAMBI SOTTO ELENCAE
SPARE PARTS KIT ADVISED
TO THE REPAIR CENTERS. THIS KIT INCLUDES ALL THE SPARE PARTS SHOWN HERE UNDER

CODICE CODE	DESCRIZIONE DESCRIPTION	Q.TÀ QTY
KR3209	LEVA E TUBO DI EROGAZIONE LEVER AND DELIVERY HOSE	1
KR3251	KIT GUARNIZIONI COMPLETO COMPLETE GASKETS KIT	1



Art. 32067 Mod. DO.C. 65L - Art. 32068 Mod. DO.C. 65L



VISTA ESPLOSA - EXPLODED VIEW



DISTRIBUTORE D'OLIO CON
SERBATOIO CARRELLATO DA 65 l
OIL DISPENSER
WITH WHEEL- MOUNTED 65 l TANK

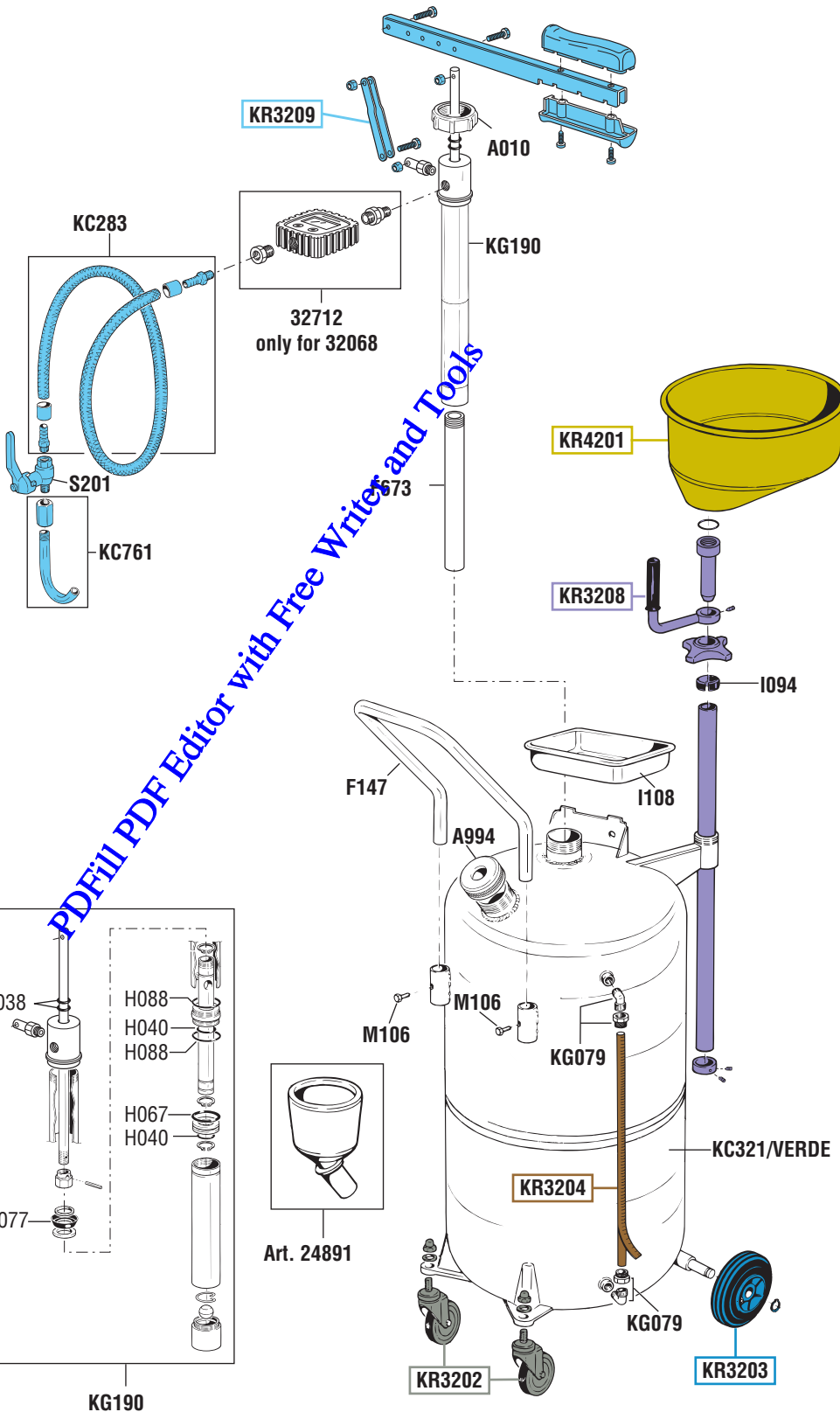

PDFill PDF Editor with Free Writer and Tools

tutti i diritti riservati - all rights reserved

GUIDA RICAMBI - SPARE PARTS GUIDE

KIT RICAMBI OGNI KIT SOTTO RIPORTATO COMPRENDE I RICAMBI EVIDENZIATI CON LO STESSO COLORE E LE RELATIVE GUARNIZIONI. QUESTI RICAMBI NON SONO FORNIBILI SEPARATAMENTE TRANNE QUELLI CODIFICATI.		
SPARE PARTS KITS EACH KIT SHOWN WITH THE SAME COLOR INCLUDES ALSO THE GASKETS. THE SPARE PARTS INCLUDED IN THE KIT CAN'T BE SUPPLIED SEPARATELY EXCEPT THOSE SHOWN WITH A PROPER CODE.		
CODICE CODE	DESCRIZIONE DESCRIPTION	Q.TÀ QTY
KR3202	DUE RUOTE PIROETTANTI CON DADI TWO SWIVELLING WHEELS WITH NUTS	1
KR3203	2 RUOTE FISSE CON ANELLI ELASTICI 2 FIXED WHEELS WITH RETAININGS RINGS	1
KR3204	TUBO DI LIVELLO ED ETICHETTA GAUGE TUBE AND LABEL	1
KR3208	GRUPPO SUPPORTO COPPA BOWL SUPPORT UNIT	1
KR3209	LEVA E TUBO DI EROGAZIONE LEVER AND DELIVERY HOSE	1
KR4201	COPPA RACCOGLI OLIO OIL COLLECTING BOWL	1

ELENCO RICAMBI FORNIBILI SINGOLARMENTE LIST OF SPARE PARTS WHICH CAN BE SUPPLIED SEPARATELY		
CODICE CODE	DESCRIZIONE DESCRIPTION	Q.TÀ QTY
24891	IMBUTO FUNNEL	1
32712	CONTALITRI DIGITALE DIGITAL OIL METER	1
A010	GHIERA UNIVERSALE UNIVERSAL RING	1
A994	TAPPO BASSA PRESSIONE LOW PRESSURE PLUG	1
F147	MANICO A "U" HANDLE	1
F673	PROLUNGA 250 mm EXTENSION 250 mm	1
I094	OGIVA STRINGI TUBO CLAMPING TUBE OGIVE	1
I108	VASCHETTA PORTA OGGETTI TOOL TRAY	1
KC283	TUBO COLLEGAMENTO CONNECTING HOSE	1
KC321/VERDE	SERBATOIO 65 l RESERVOIR 65 l	1
KC761	TERMINALE TERMINAL	1
KG079	GRUPPO GOMITO E GHIERA RING AND ELBOW JOINT GROUP	2
KG190	POMPA OLIO MANUALE MANUAL PUMP GROUP	2
M106	VITE M6 x 8 SCREW M6 x 8	2
S201	RUBINETTO A SFERA 1/4" BALL VALVE 1/4"	1

Art. KR3251 KIT GUARNIZIONI COMPLETO COMPOSTO DALLE GUARNIZIONI SOTTO ELENCAE JOINTS GASKETS LIST INCLUDING ALL THE GASKETS SHOWN HERE UNDER		
CODICE CODE	DESCRIZIONE DESCRIPTION	Q.TÀ QTY
H037	O-RING 3137 O-RING 3137	1
H038	O-RING 115 O-RING 115	2
H040	O-RING 123 O-RING 123	2
H067	O-RING 4112 O-RING 4112	1
H077	GUARNIZIONE GASKET	1
H088	O-RING 2106 "NBR 70" O-RING 2106 "NBR 70"	2

Art. KS3281 SET RICAMBI CONSIGLIATI AI PUNTI VENDITA E ASSISTENZA, COMPOSTO DAI RICAMBI SOTTO ELENCAE SPARE PARTS KIT ADVISED TO THE REPAIR CENTERS. THIS KIT INCLUDES ALL THE SPARE PARTS SHOWN HERE UNDER		
CODICE CODE	DESCRIZIONE DESCRIPTION	Q.TÀ QTY
KR3209	LEVA E TUBO DI EROGAZIONE LEVER AND DELIVERY HOSE	1
KR3251	KIT GUARNIZIONI COMPLETO COMPLETE GASKETS KIT	1

PDFfill PDF Editor with Free Writer and Tools

RAASM

FLUIDS AND LUBRICATION EQUIPMENT



33/101160 Mod. DA 1" NBR 16060
33/2511NHH2 Mod. DA 1" NBR 6060



VISTA ESPLOSA - EXPLODED VIEW



POMPA A MEMBRANA
SERIE 1"
DIAPHRAGM PUMP
SERIES 1"

! Per aumentare le prestazioni delle pompe a membrana è stato rivisto il gruppo motore. Ne consegue che i ricambi delle pompe in oggetto non sono più fornibili.

Il vecchio gruppo valido fino all'anno 2008 compreso (verificare n° di serie sulla targhetta in alluminio) composto da tutti i ricambi qui riportati è stato sostituito con il nuovo gruppo motore - KR33/108

To increase the performance of diaphragm pumps, the motor has been revised. It follows that the parts of the pumps in question are no longer supplied.

The old group valid until the year 2008 inclusive (check the serial number on the aluminum plate) consisting of all the parts shown here has been replaced with the new motor - KR33/108

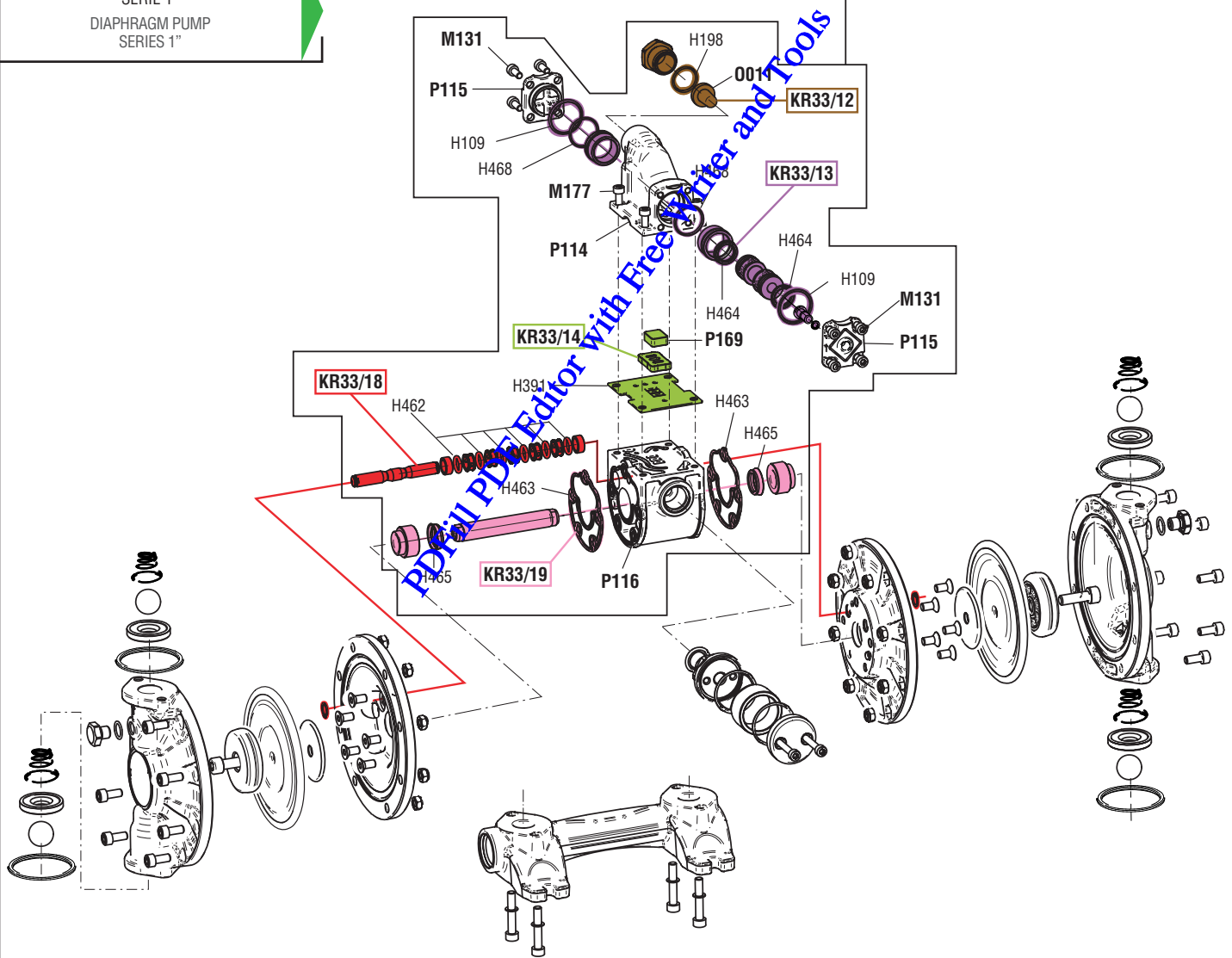
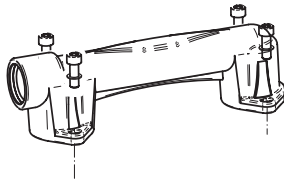

tutti i diritti riservati - all rights reserved



33/3011NHHV2 Mod. DA 1.1/4" NBR 20060



VISTA ESPLOSA - EXPLODED VIEW



POMPA A MEMBRANA
SERIE 1.1/4"
DIAPHRAGM PUMP
SERIES 1.1/4"

! Per aumentare le prestazioni delle pompe a membrana è stato rivisto il distributore aria. Ne consegue che **i ricambi della pompa in oggetto non sono più fornibili.**

Il vecchio distributore aria, valido fino all'anno 2010 compreso (verificare n° di serie sulla targhetta in alluminio) composto da tutti i ricambi qui riportati è stato sostituito con **il nuovo distributore aria - KR33/118**

To increase the performance of diaphragm pumps, the air distributor has been revised. It follows that the parts of the pump in question are no longer supplied.

The old air distributor valid until the year 2010 inclusive (check the serial number on the aluminum plate) consisting of all the parts shown here has been replaced with the new air distributor - **KR33/118**

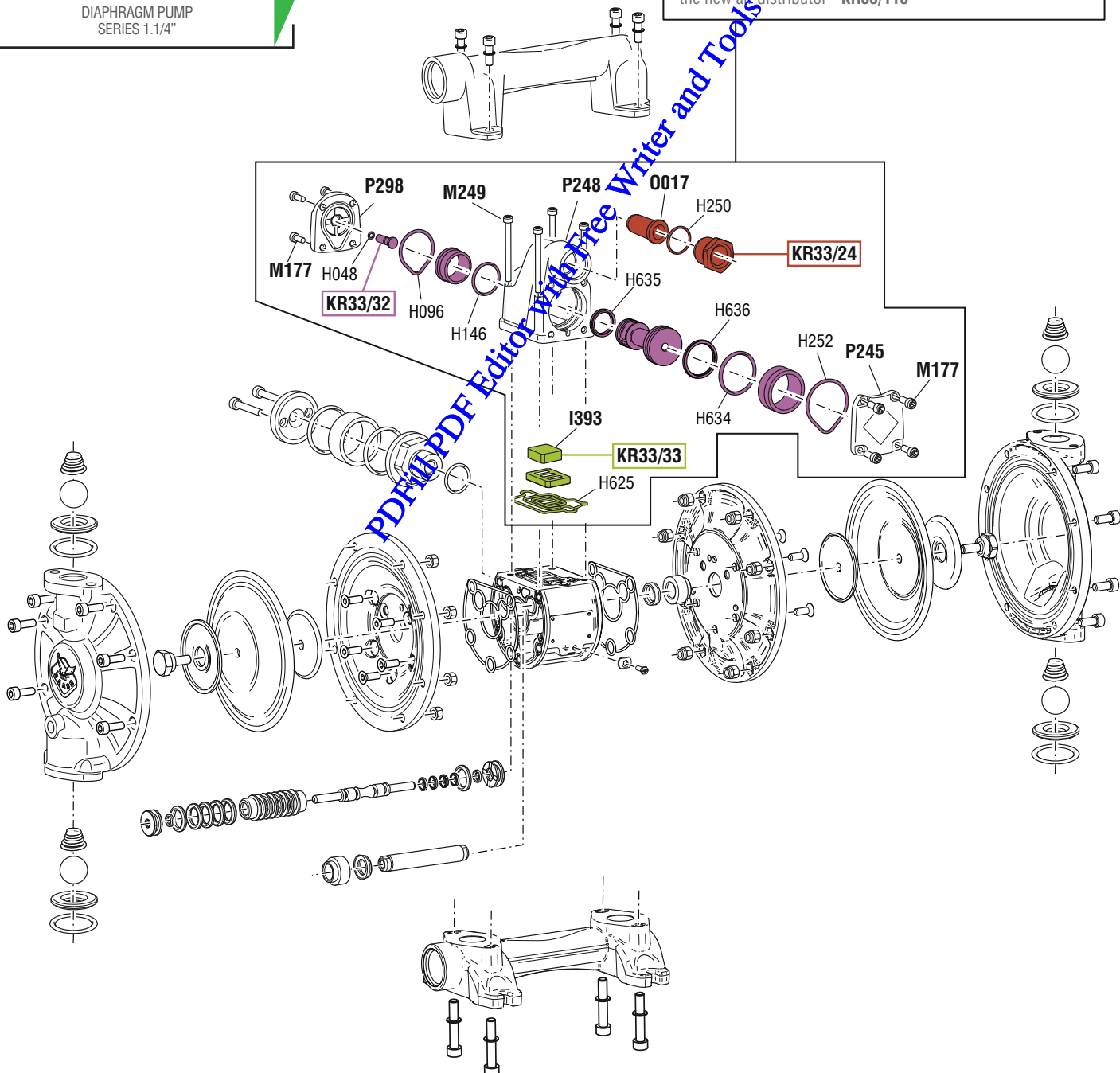

tutti i diritti riservati - all rights reserved



33/2011NHHV2 Mod. DA 3/4" NBR 7060



VISTA ESPLOSA - EXPLODED VIEW



POMPA A MEMBRANA
SERIE 3/4"
DIAPHRAGM PUMP
SERIES 3/4"

! Per aumentare le prestazioni delle pompe a membrana è stato rivisto il distributore aria. Ne consegue che i ricambi della pompa in oggetto non sono più fornibili.

Il vecchio distributore aria, valido fino all'anno 2010 compreso (verificare n° di serie sulla targhetta in alluminio) composto da tutti i ricambi qui riportati è stato sostituito con il nuovo distributore aria - KR33/116

To increase the performance of diaphragm pumps, the air distributor has been revised. It follows that the parts of the pump in question are no longer supplied.

The old air distributor valid until the year 2010 inclusive (check the serial number on the aluminum plate) consisting of all the parts shown here has been replaced with the new air distributor - KR33/116

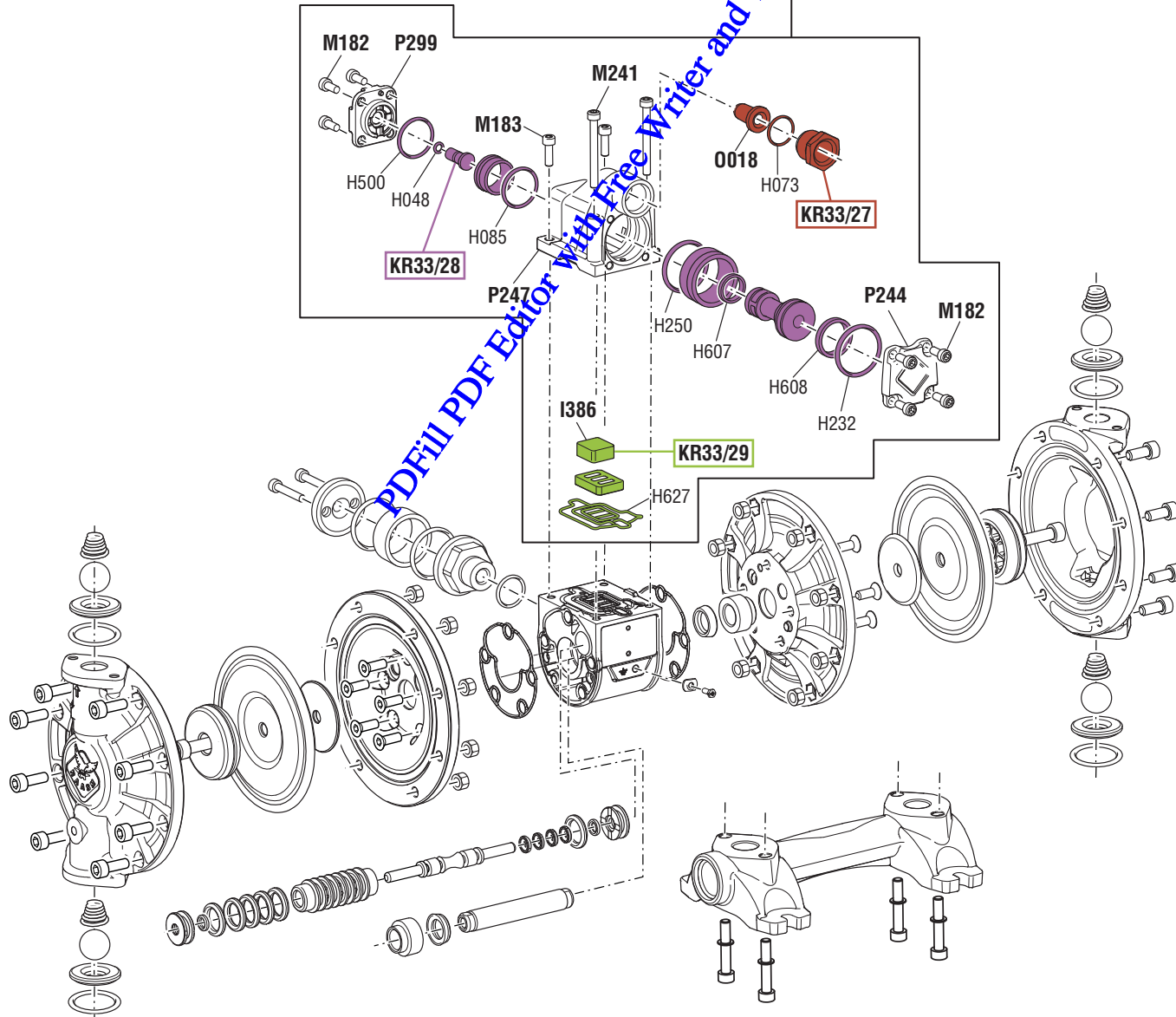
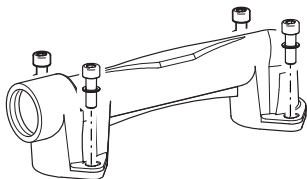

tutti i diritti riservati - all rights reserved



Art. 33/2011NHHV2 Mod. AB-34-N-7060 - Art. 33/2011TPT2 Mod. AB-34-T5560
 Art. 33/2011HHV2 Mod. AB-34-H-7060 - Art. 33/2011EDF2 Mod. AB-34-E-7060
 Art. 33/2011SDDF2 Mod. AB-34-S-7060



VISTA ESPLOSA - EXPLODED VIEW

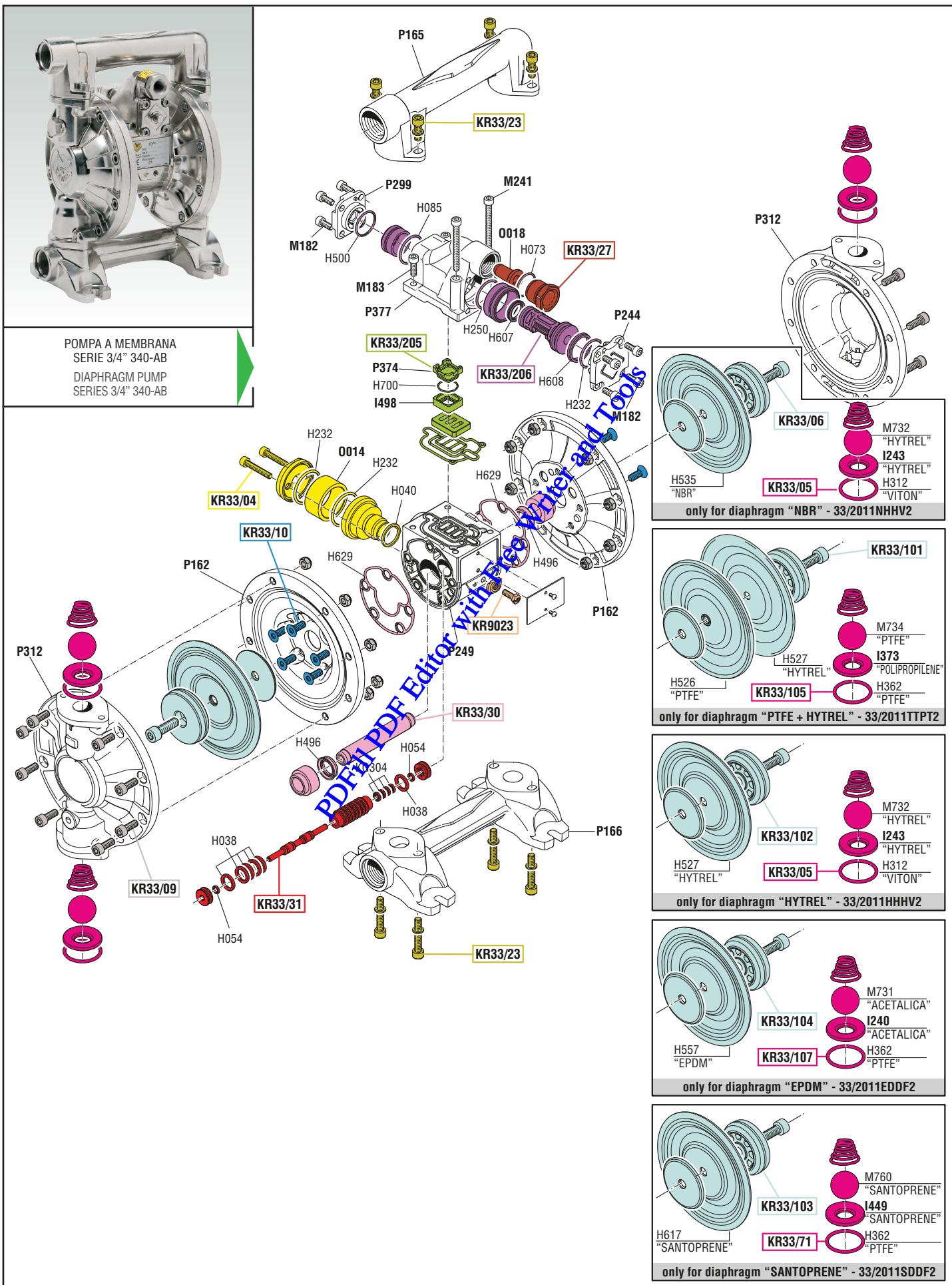

POMPA A MEMBRANA
 SERIE 3/4" 340-AB
 DIAPHRAGM PUMP
 SERIES 3/4" 340-AB

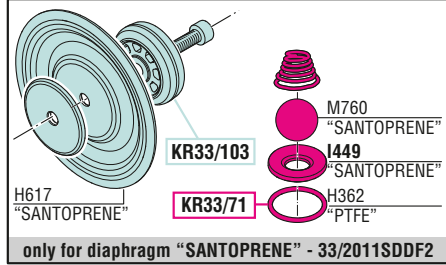
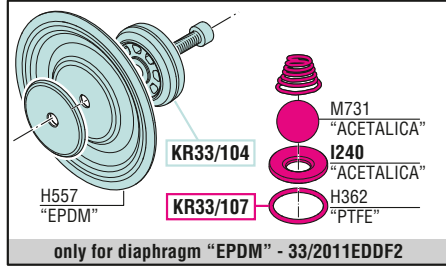
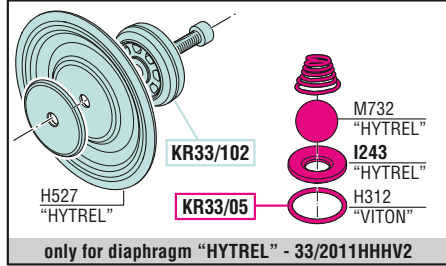
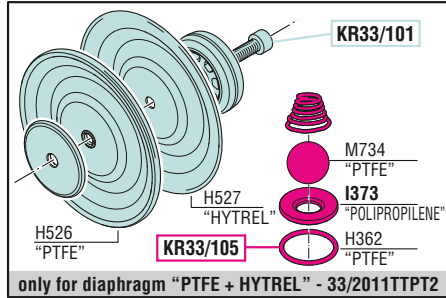
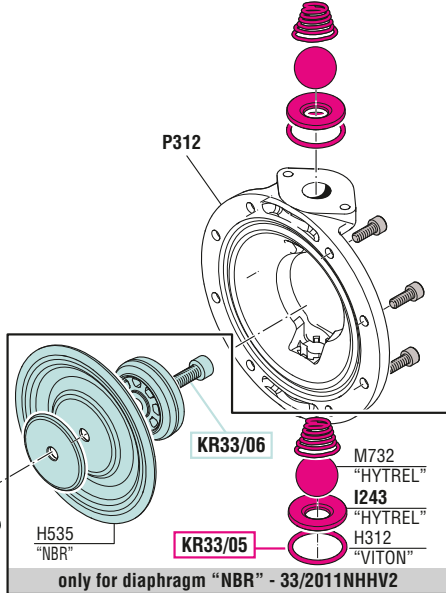

tutti i diritti riservati - all rights reserved

GUIDA RICAMBI - SPARE PARTS GUIDE

KIT RICAMBI OGNI KIT SOTTO RIPORTATO COMPRENDE I RICAMBI EVIDENZIATI CON LO STESSO COLORE E LE RELATIVE GUARNIZIONI. QUESTI RICAMBI NON SONO FORNIBILI SEPARATAMENTE TRANNE QUELLI CODIFICATI.		
SPARE PARTS KITS EACH KIT SHOWN WITH THE SAME COLOR INCLUDES ALSO THE GASKETS. THE SPARE PARTS INCLUDED IN THE KIT CAN'T BE SUPPLIED SEPARATELY EXCEPT THOSE SHOWN WITH A PROPER CODE.		
CODICE CODE	DESCRIZIONE DESCRIPTION	Q.TÀ QTY
KR33/06	GRUPPO MEMBRANE "NBR" DIAPHRAGM GROUP "NBR"	1
KR33/101	GRUPPO MEMBRANE "PTFE + HYTREL" DIAPHRAGM GROUP "PTFE + HYTREL"	1
KR33/102	GRUPPO MEMBRANE "HYTREL" DIAPHRAGM GROUP "HYTREL"	1
KR33/103	GRUPPO MEMBRANE "SANTOPRENE" DIAPHRAGM GROUP "SANTOPRENE"	1
KR33/104	GRUPPO MEMBRANE "EPDM" DIAPHRAGM GROUP "EPDM"	1
KR33/05	GRUPPO VALVOLE (33/2011NHHV2, 33/2011HHV2) VALVE GROUP (33/2011NHHV2, 33/2011HHV2)	1
KR33/71	GRUPPO VALVOLE (solo per 33/2011SDDF2) VALVE GROUP (only for 33/2011SDDF2)	1
KR33/105	GRUPPO VALVOLE (solo per 33/2011TPT2) VALVE GROUP (only for 33/2011TPT2)	1
KR33/107	GRUPPO VALVOLE (solo per 33/2011EDDF2) VALVE GROUP (only for 33/2011EDDF2)	1
KR33/04	SILENZIATORE MUFFLER	1
KR33/09	VITERIA FLANGE FLANGES SCREWS	1
KR33/10	VITERIA MOTORE MOTOR SCREWS	1
KR33/23	VITERIA COLLETTORI MANIFOLDS SCREWS	1
KR33/27	ENTRATA ARIA AIR INLET	1
KR33/30	GRUPPO ALBERO PISTONE PISTON SHAFT GROUP	1
KR33/31	GRUPPO PERNO PILOTA PILOT PIN GROUP	1
KR33/205	GRUPPO DISTRIBUTORE DISTRIBUTOR KIT	1
KR33/206	GRUPPO INVERTITORE AIR SWITCH KIT	1
KR9023	MESSA A TERRA GROUNDED	1

ELENCORICAMBI FORNIBILI SINGOLARMENTE

LIST OF SPARE PARTS WHICH CAN BE SUPPLIED SEPARATELY

CODICE CODE	DESCRIZIONE DESCRIPTION	Q.TÀ QTY
H700	GUARNIZIONE DISTRIBUTORE MOTORE ENGINE GASKET DISTRIBUTOR	1
I498	PARTE INFERIORE DISTRIBUTORE MOTORE BOTTOM ENGINE DISTRIBUTOR	1
M182	VITE INOX M45x12 STAINLESS STEEL SCREW M45x12	8
M183	VITE INOX M5x16 STAINLESS STEEL SCREW M5x16	2
M241	VITE INOX M5x50 STAINLESS STEEL SCREW M5x50	2
0014	SILENZIATORE MUFFLER	1
0018	FILTRO ENTRATA INLET FILTER	1
P162	FLANGIA INTERNA INTERNAL FLANGE	2
P165	COLLETTORE SUPERIORE OUTLET MANIFOLD	1
P166	COLLETTORE INFERIORE INLET MANIFOLD	1
P244	COPERCHIO COVER	1
P249	CORPO CENTRALE CENTRAL BODY	1
P299	COPERCHIO COVER	1
P312	FLANGIA ESTERNA EXTERNAL FLANGE	2
P374	PARTE SUPERIORE DISTRIBUTORE MOTORE TOP ENGINE DISTRIBUTOR	1
P377	CORPO DISTRIBUTORE AIR DISTRIBUTOR BODY	1
H526	MEMBRANA "PTFE" DIAPHRAGM "PTFE"	2
H527	MEMBRANA "HYTREL" DIAPHRAGM "HYTREL"	2
H535	MEMBRANA "NBR" DIAPHRAGM "NBR"	2
H557	MEMBRANA "EPDM" DIAPHRAGM "EPDM"	2
H617	MEMBRANA "SANTOPRENE" PLATE "SANTOPRENE"	2
H312	GUARNIZIONE O-RING 3118 "VITON" O-RING 3118 "VITON"	4
H362	GUARNIZIONE O-RING 3118 "PTFE" O-RING 3118 "PTFE"	4
I240	SEDE VALVOLA "ACETALICA" SEAT VALVE "ACETALICA"	4
I243	SEDE VALVOLA "HYTREL" SEAT VALVE "HYTREL"	4
I373	SEDE VALVOLA "POLIPROPILENE" SEAT VALVE "POLIPROPILENE"	4
I449	SEDE VALVOLA "SANTOPRENE" SEAT VALVE "SANTOPRENE"	4
M731	SFERA VALVOLA "ACETALICA" BALL VALVE "ACETALICA"	4
M732	SFERA VALVOLA "HYTREL" BALL VALVE "HYTREL"	4
M734	SFERA VALVOLA "PTFE" BALL VALVE "PTFE"	4
M760	SFERA VALVOLA "SANTOPRENE" BALL VALVE "SANTOPRENE"	4

KIT COMPLETO

TUTTE LE GUARNIZIONI (H...) MENZIONATE NELL'ESPLOSO SONO FORNIBILI ANCHE SINGOLARMENTE

COMPLETE KIT

ALL THE O-RING (H...) MENTIONED IN THE EXPLODED VIEW CAN BE SUPPLIED SEPARATELY

CODICE CODE	DESCRIZIONE DESCRIPTION	Q.TÀ QTY
KR33/72	KIT MEMBRANE + VALVOLE (solo per 33/2011HHV2) DIAPHRAGM + VALVE KIT (only for 33/2011HHV2)	1
KR33/73	KIT MEMBRANE + VALVOLE (solo per 33/2011TPT2) DIAPHRAGM + VALVE KIT (only for 33/2011TPT2)	1
KR33/74	KIT MEMBRANE + VALVOLE (solo per 33/2011EDDF2) DIAPHRAGM + VALVE KIT (only for 33/2011EDDF2)	1
KR33/75	KIT MEMBRANE + VALVOLE (solo per 33/2011SDDF2) DIAPHRAGM + VALVE KIT (only for 33/2011SDDF2)	1
KR33/76	KIT MEMBRANE + VALVOLE (solo per 33/2011NHHV2) DIAPHRAGM + VALVE KIT (only for 33/2011NHHV2)	1
KR33/209	KIT GUARNIZIONI DISTRIBUTORE ARIA AIR DISTRIBUTOR GASKETS KIT	1
KR33/210	KIT GUARNIZIONI CORPO MOTORE MOTOR GASKETS KIT	1

SET RICAMBI CONSIGLIATI

AI PUNTI VENDITA E ASSISTENZA, COMPOSTO DAI RICAMBI SOTTO ELENCATI

SPARE PARTS KIT ADVISED

TO THE REPAIR CENTERS. THIS KIT INCLUDES ALL THE SPARE PARTS SHOWN HERE UNDER

CODICE CODE	DESCRIZIONE DESCRIPTION	Q.TÀ QTY
KS33/135	KR33/209, KR33/210, KR33/76 (solo per/only for: 33/2011NHHV2)	1
KS33/136	KR33/209, KR33/210, KR33/72 (solo per/only for: 33/2011HHV2)	1
KS33/137	KR33/209, KR33/210, KR33/73 (solo per/only for: 33/2011TPT2)	1
KS33/138	KR33/209, KR33/210, KR33/74 (solo per/only for: 33/2011EDDF2)	1
KS33/139	KR33/209, KR33/210, KR33/75 (solo per/only for: 33/2011SDDF2)	1

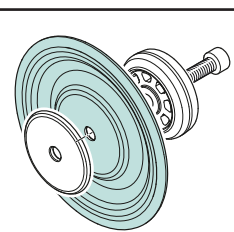

RAASM

FLUIDS AND LUBRICATION EQUIPMENT



Art. 33/2611NHHV2 Mod. AB-1-N-17060 - Art. 33/2611TTPT2 Mod. AB-1-T-15060
 Art. 33/2611HHV2 Mod. AB-1-H-17060 - Art. 33/2611EDDF2 Mod. AB-1-E-17060
 Art. 33/2611SDDF2 Mod. AB-1-S-17060



VISTA ESPLOSA - EXPLODED VIEW

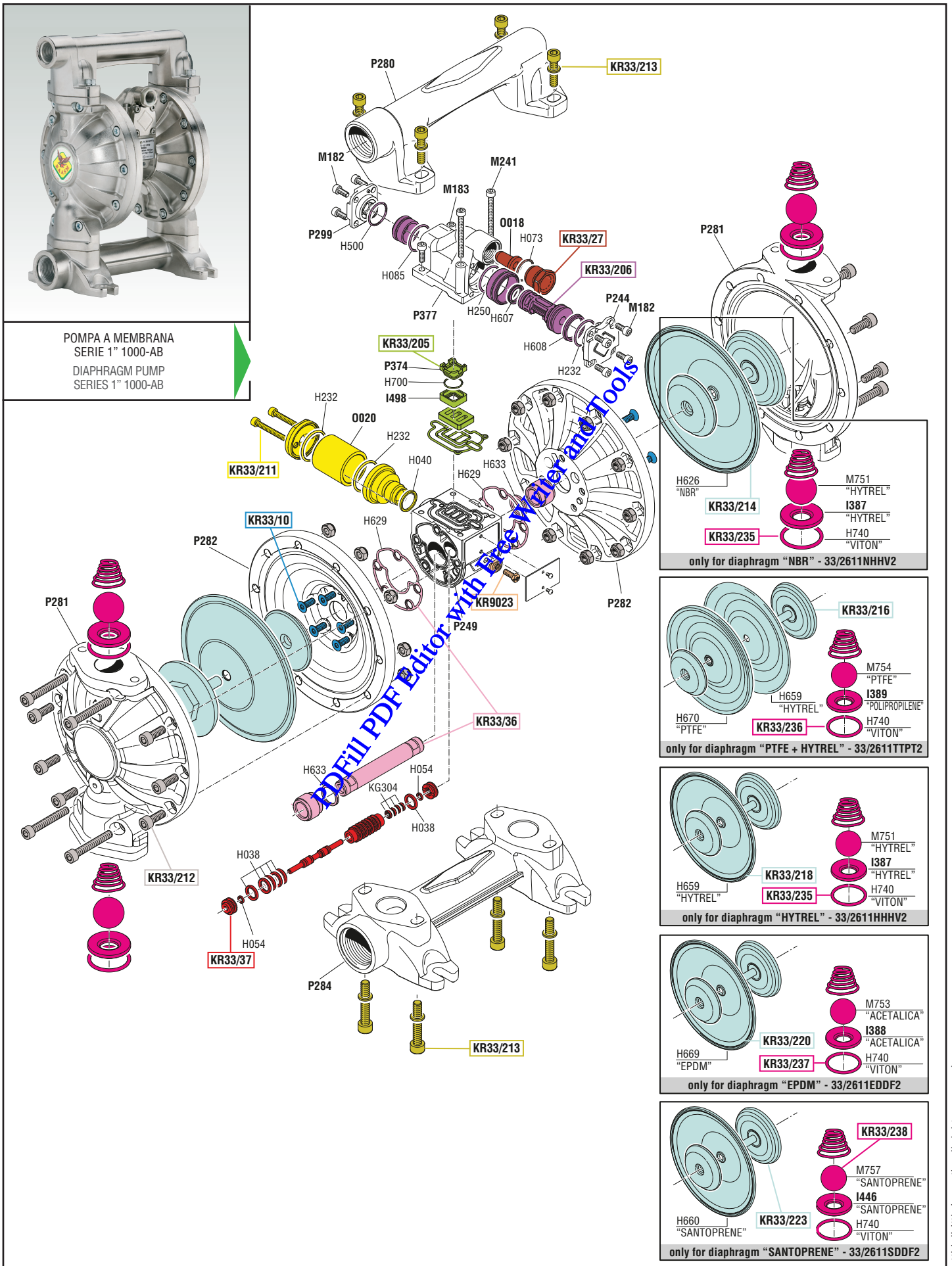

PDFFill PDF Editor with Free Watermark Tools

tutti i diritti riservati - all rights reserved

GUIDA RICAMBI - SPARE PARTS GUIDE

KIT RICAMBI
OGNI KIT SOTTO RIPORTATO COMPRENDE I RICAMBI EVIDENZIATI CON LO STESSO COLORE E LE RELATIVE GUARNIZIONI. QUESTI RICAMBI NON SONO FORNIBILI SEPARATAMENTE TRANNE QUELLI CODIFICATI.

SPARE PARTS KITS
EACH KIT SHOWN WITH THE SAME COLOR INCLUDES ALSO THE GASKETS. THE SPARE PARTS INCLUDED IN THE KIT CAN'T BE SUPPLIED SEPARATELY EXCEPT THOSE SHOWN WITH A PROPER CODE.

CODICE CODE	DESCRIZIONE DESCRIPTION	Q.TÀ QTY
KR33/214	GRUPPO MEMBRANE "NBR" DIAPHRAGM GROUP "NBR"	1
KR33/216	GRUPPO MEMBRANE "PTFE + HYTREL" DIAPHRAGM GROUP "PTFE + HYTREL"	1
KR33/218	GRUPPO MEMBRANE "HYTREL" DIAPHRAGM GROUP "HYTREL"	1
KR33/220	GRUPPO MEMBRANE "EPDM" DIAPHRAGM GROUP "EPDM"	1
KR33/223	GRUPPO MEMBRANE "SANTOPRENE" DIAPHRAGM GROUP "SANTOPRENE"	1
KR33/235	GRUPPO VALVOLE (33/2611NHHV2, 33/2611HHV2) VALVE GROUP (33/2611NHHV2, 33/2611HHV2)	1
KR33/236	GRUPPO VALVOLE (solo per 33/2611TPT2) VALVE GROUP (only for 33/2611TPT2)	1
KR33/237	GRUPPO VALVOLE (solo per 33/2611EDDF2) VALVE GROUP (only for 33/2611EDDF2)	1
KR33/238	GRUPPO VALVOLE (solo per 33/2611SDDF2) VALVE GROUP (only for 33/2611SDDF2)	1
KR33/10	VITERIA MOTORE MOTOR SCREWS	1
KR33/27	ENTRATA ARIA AIR INLET	1
KR33/36	GRUPPO ALBERO PISTONE PISTON SHAFT GROUP	1
KR33/37	GRUPPO PERNO PILOTA PILOT PIN GROUP	1
KR33/205	GRUPPO DISTRIBUTORE DISTRIBUTOR KIT	1
KR33/206	GRUPPO INVERTITORE AIR SWITCH KIT	1
KR33/211	SILENZIATORE MUFFLER	1
KR33/212	VITERIA FLANGE FLANGES SCREWS	1
KR33/213	VITERIA COLLETTORI MANIFOLDS SCREWS	1
KR9023	MESSA A TERRA GROUNDED	1

ELENCO RICAMBI FORNIBILI SINGOLARMENTE

LIST OF SPARE PARTS WHICH CAN BE SUPPLIED SEPARATELY

CODICE CODE	DESCRIZIONE DESCRIPTION	Q.TÀ QTY
H700	GUARNIZIONE DISTRIBUTORE MOTORE ENGINE GASKET DISTRIBUTOR	1
I498	PARTE INFERIORE DISTRIBUTORE MOTORE BOTTOM ENGINE DISTRIBUTOR	1
M182	VITE INOX M45x12 STAINLESS STEEL SCREW M45x12	8
M183	VITE INOX M5x16 STAINLESS STEEL SCREW M5x16	2
M241	VITE INOX M5x50 STAINLESS STEEL SCREW M5x50	2
0018	FILTRO ENTRATA INLET FILTER	1
0020	SILENZIATORE MUFFLER	1
P244	COPERCHIO COVER	1
P249	CORPO CENTRALE CENTRAL BODY	1
P280	COLLETTORE SUPERIORE OUTLET MANIFOLD	1
P281	FLANGIA ESTERNA EXTERNAL FLANGE	2
P282	FLANGIA INTERNA INTERNAL FLANGE	2
P284	COLLETTORE INFERIORE INLET MANIFOLD	1
P299	COPERCHIO COVER	1
P374	PARTE SUPERIORE DISTRIBUTORE MOTORE TOP ENGINE DISTRIBUTOR	1
P377	CORPO DISTRIBUTORE AIR DISTRIBUTOR BODY	1
H626	MEMBRANA "NBR" DIAPHRAGM "NBR"	2
H659	MEMBRANA "HYTREL" DIAPHRAGM "HYTREL"	2
H660	MEMBRANA "SANTOPRENE" LATE "SANTOPRENE"	2
H669	MEMBRANA "EPDM" DIAPHRAGM "EPDM"	2
H670	MEMBRANA "PTFE" DIAPHRAGM "PTFE"	2
H740	GUARNIZIONE O-RING "VITON" O-RING "VITON"	4
I387	SEDE VALVOLA "HYTREL" SEAT VALVE "HYTREL"	4
I388	SEDE VALVOLA "ACETALICA" SEAT VALVE "ACETALICA"	4
I389	SEDE VALVOLA "POLIPROPILENE" SEAT VALVE "POLIPROPILENE"	4
I446	SEDE VALVOLA "SANTOPRENE" SEAT VALVE "SANTOPRENE"	4
M751	SFERA VALVOLA "HYTREL" BALL VALVE "HYTREL"	4
M753	SFERA VALVOLA "ACETALICA" BALL VALVE "ACETALICA"	4
M754	SFERA VALVOLA "PTFE" BALL VALVE "PTFE"	4
M757	SFERA VALVOLA "SANTOPRENE" BALL VALVE "SANTOPRENE"	4

KIT COMPLETO
TUTTE LE GUARNIZIONI (H...) MENZIONATE NELL'ESPLOSO SONO FORNIBILI ANCHE SINGOLARMENTE

COMPLETE KIT

ALL THE O-RING (H...) MENTIONED IN THE EXPLODED VIEW CAN BE SUPPLIED SEPARATELY

CODICE CODE	DESCRIZIONE DESCRIPTION	Q.TÀ QTY
KR33/209	KIT GUARNIZIONI DISTRIBUTORE ARIA AIR DISTRIBUTOR GASKETS KIT	1
KR33/234	KIT GUARNIZIONI CORPO MOTORE MOTOR GASKETS KIT	1
KR33/239	KIT MEMBRANE + VALVOLE (solo per 33/2611NHHV2) DIAPHRAGM + VALVE KIT (only for 33/2611NHHV2)	1
KR33/240	KIT MEMBRANE + VALVOLE (solo per 33/2611TPT2) DIAPHRAGM + VALVE KIT (only for 33/2611TPT2)	1
KR33/241	KIT MEMBRANE + VALVOLE (solo per 33/2611EDDF2) DIAPHRAGM + VALVE KIT (only for 33/2611EDDF2)	1
KR33/242	KIT MEMBRANE + VALVOLE (solo per 33/2611SDDF2) DIAPHRAGM + VALVE KIT (only for 33/2611SDDF2)	1
KR33/243	KIT MEMBRANE + VALVOLE (solo per 33/2611HHV2) DIAPHRAGM + VALVE KIT (only for 33/2611HHV2)	1

SET RICAMBI CONSIGLIATI

AI PUNTI VENDITA E ASSISTENZA. COMPOSTO DAI RICAMBI SOTTO ELENCATI

SPARE PARTS KIT ADVISED

TO THE REPAIR CENTERS. THIS KIT INCLUDES ALL THE SPARE PARTS SHOWN HERE UNDER

CODICE CODE	DESCRIZIONE DESCRIPTION	Q.TÀ QTY
KS33/110	KR33/209, KR33/234, KR33/239 (solo per/only for: 33/2611NHHV2)	1
KS33/111	KR33/209, KR33/234, KR33/241 (solo per/only for: 33/2611EDDF2)	1
KS33/112	KR33/209, KR33/234, KR33/240 (solo per/only for: 33/2611TPT2)	1
KS33/113	KR33/209, KR33/234, KR33/242 (solo per/only for: 33/2611SDDF2)	1
KS33/114	KR33/209, KR33/234, KR33/243 (solo per/only for: 33/2611HHV2)	1

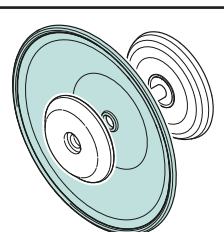



Art. 33/3011NHHV2 Mod. AB-114-N-20060 - Art. 33/3011TPT2 Mod. AB-114-T-17060
 Art. 33/3011HHV2 Mod. AB-114-H-20060 - Art. 33/3011EDDF2 Mod. AB-114-E-20060
 Art. 33/3011SDDF2 Mod. AB-114-S-20060



VISTA ESPLOSA - EXPLODED VIEW

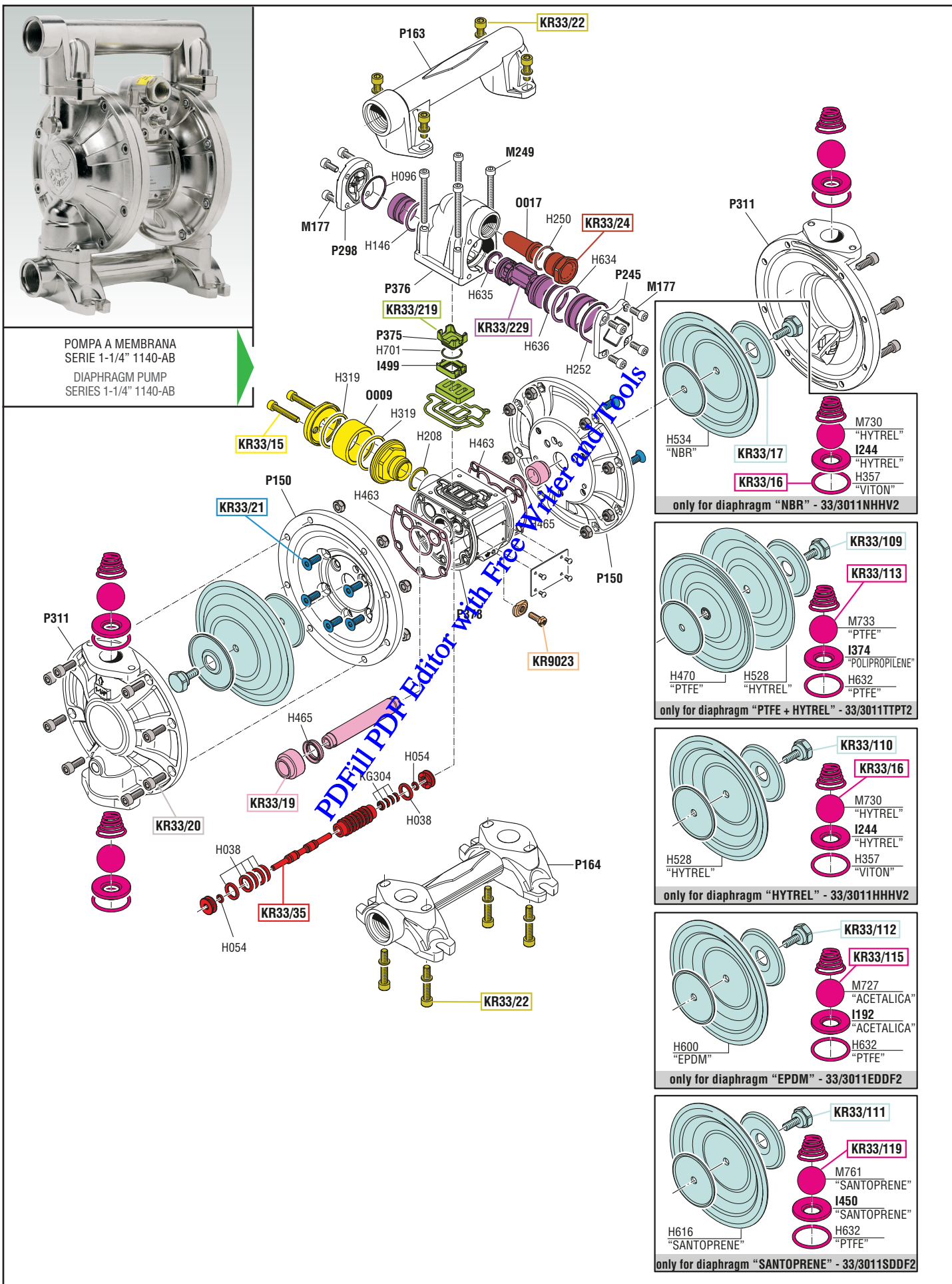

tutti i diritti riservati - all rights reserved

GUIDA RICAMBI - SPARE PARTS GUIDE

KIT RICAMBI OGNI KIT SOTTO RIPORTATO COMPRENDE I RICAMBI EVIDENZIATI CON LO STESSO COLORE E LE RELATIVE GUARNIZIONI. QUESTI RICAMBI NON SONO FORNIBILI SEPARATAMENTE TRANNE QUELLI CODIFICATI. SPARE PARTS KITS EACH KIT SHOWN WITH THE SAME COLOR INCLUDES ALSO THE GASKETS. THE SPARE PARTS INCLUDED IN THE KIT CAN'T BE SUPPLIED SEPARATELY EXCEPT THOSE SHOWN WITH A PROPER CODE.		
CODICE CODE	DESCRIZIONE DESCRIPTION	Q.TÀ QTY
KR33/17	GRUPPO MEMBRANE "NBR" DIAPHRAGM GROUP "NBR"	1
KR33/109	GRUPPO MEMBRANE "PTFE + HYTREL" DIAPHRAGM GROUP "PTFE + HYTREL"	1
KR33/110	GRUPPO MEMBRANE "HYTREL" DIAPHRAGM GROUP "HYTREL"	1
KR33/111	GRUPPO MEMBRANE "SANTOPRENE" DIAPHRAGM GROUP "SANTOPRENE"	1
KR33/112	GRUPPO MEMBRANE "EPDM" DIAPHRAGM GROUP "EPDM"	1
KR33/16	GRUPPO VALVOLE (33/3011NHHV2, 33/3011HHV2) VALVE GROUP (33/3011NHHV2, 33/3011HHV2)	1
KR33/113	GRUPPO VALVOLE (solo per 33/3011TPT2) VALVE GROUP (only for 33/3011TPT2)	1
KR33/115	GRUPPO VALVOLE (solo per 33/3011EDDF2) VALVE GROUP (only for 33/3011EDDF2)	1
KR33/119	GRUPPO VALVOLE (solo per 33/3011SDDF2) VALVE GROUP (only for 33/3011SDDF2)	1
KR33/15	SILENZIATORE MUFFLER	1
KR33/19	GRUPPO ALBERO PISTONE PISTON SHAFT GROUP	1
KR33/20	VITERIA FLANGE FLANGES SCREWS	1
KR33/21	VITERIA MOTORE MOTOR SCREWS	1
KR33/22	VITERIA COLLETTORI MANIFOLDS SCREWS	1
KR33/24	ENTRATA ARIA AIR INLET	1
KR33/35	GRUPPO PERNO PILOTA PILOT PIN GROUP	1
KR33/219	GRUPPO DISTRIBUTORE DISTRIBUTOR KIT	1
KR33/229	GRUPPO INVERTITORE AIR SWITCH KIT	1
KR9023	MESSA A TERRA GROUNDED	1

ELENCORICAMBI FORNIBILI SINGOLARMENTE

LIST OF SPARE PARTS WHICH CAN BE SUPPLIED SEPARATELY

CODICE CODE	DESCRIZIONE DESCRIPTION	Q.TÀ QTY
H701	GUARNIZIONE DISTRIBUTORE MOTORE ENGINE GASKET DISTRIBUTOR	1
I499	PARTE INFERIORE DISTRIBUTORE MOTORE BOTTOM ENGINE DISTRIBUTOR	1
M177	VITE INOX M6x20 STAINLESS STEEL SCREW M6x20	8
M249	VITE INOX M6x65 STAINLESS STEEL SCREW M6x65	4
0009	SILENZIATORE MUFFLER	1
0017	FILTRO ENTRATA INLET FILTER	1
P150	FLANGIA INTERNA INTERNAL FLANGE	2
P163	COLLETTORE SUPERIORE OUTLET MANIFOLD	1
P164	COLLETTORE INFERIORE INLET MANIFOLD	1
P245	COPERCHIO COVER	1
P298	COPERCHIO COVER	1
P311	FLANGIA ESTERNA EXTERNAL FLANGE	2
P375	PARTE SUPERIORE DISTRIBUTORE MOTORE TOP ENGINE DISTRIBUTOR	1
P376	CORPO DISTRIBUTORE AIR DISTRIBUTOR BODY	1
P378	CORPO CENTRALE CENTRAL BODY	1
H470	MEMBRANA "PTFE" DIAPHRAGM "PTFE"	2
H528	MEMBRANA "HYTREL" DIAPHRAGM "HYTREL"	2
H534	MEMBRANA "NBR" DIAPHRAGM "NBR"	2
H600	MEMBRANA "EPDM" DIAPHRAGM "EPDM"	2
H616	MEMBRANA "SANTOPRENE" PLATE "SANTOPRENE"	2
H632	GUARNIZIONE O-RING 3200 "VITON" O-RING 3200 "VITON"	4
H632	GUARNIZIONE O-RING 3200 "PTFE" O-RING 3200 "PTFE"	4
I192	SEDE VALVOLA "ACETALICA" SEAT VALVE "ACETALICA"	4
I244	SEDE VALVOLA "HYTREL" SEAT VALVE "HYTREL"	4
I374	SEDE VALVOLA "POLIPROPILENE" SEAT VALVE "POLIPROPILENE"	4
I450	SEDE VALVOLA "SANTOPRENE" SEAT VALVE "SANTOPRENE"	4
M727	SFERA VALVOLA "ACETALICA" BALL VALVE "ACETALICA"	4
M730	SFERA VALVOLA "HYTREL" BALL VALVE "HYTREL"	4
M733	SFERA VALVOLA "PTFE" BALL VALVE "PTFE"	4
M761	SFERA VALVOLA "SANTOPRENE" BALL VALVE "SANTOPRENE"	4

KIT COMPLETO

TUTTE LE GUARNIZIONI (H...) MENZIONATE NELL'ESPLOSO SONO FORNIBILI ANCHE SINGOLARMENTE

COMPLETE KIT

ALL THE O-RING (H...) MENTIONED IN THE EXPLODED VIEW CAN BE SUPPLIED SEPARATELY

CODICE CODE	DESCRIZIONE DESCRIPTION	Q.TÀ QTY
KR33/78	KIT MEMBRANE + VALVOLE (solo per 33/3011NHHV2) DIAPHRAGM + VALVE KIT (only for 33/3011NHHV2)	1
KR33/79	KIT MEMBRANE + VALVOLE (solo per 33/3011TPT2) DIAPHRAGM + VALVE KIT (only for 33/3011TPT2)	1
KR33/80	KIT MEMBRANE + VALVOLE (solo per 33/3011HHV2) DIAPHRAGM + VALVE KIT (only for 33/3011HHV2)	1
KR33/81	KIT MEMBRANE + VALVOLE (solo per 33/3011EDDF2) DIAPHRAGM + VALVE KIT (only for 33/3011EDDF2)	1
KR33/82	KIT MEMBRANE + VALVOLE (solo per 33/3011SDDF2) DIAPHRAGM + VALVE KIT (only for 33/3011SDDF2)	1
KR33/258	KIT GUARNIZIONI DISTRIBUTORE ARIA AIR DISTRIBUTOR GASKETS KIT	1
KR33/274	KIT GUARNIZIONI CORPO MOTORE MOTOR GASKETS KIT	1

SET RICAMBI CONSIGLIATI

AI PUNTI VENDITA E ASSISTENZA, COMPOSTO DAI RICAMBI SOTTO ELENCATI

SPARE PARTS KIT ADVISED

TO THE REPAIR CENTERS. THIS KIT INCLUDES ALL THE SPARE PARTS SHOWN HERE UNDER

CODICE CODE	DESCRIZIONE DESCRIPTION	Q.TÀ QTY
KS33/130	KR33/258, KR33/274, KR33/78 (solo per/only for: 33/3011NHHV2)	1
KS33/131	KR33/258, KR33/274, KR33/79 (solo per/only for: 33/3011TPT2)	1
KS33/132	KR33/258, KR33/274, KR33/80 (solo per/only for: 33/3011HHV2)	1
KS33/133	KR33/258, KR33/274, KR33/81 (solo per/only for: 33/3011EDDF2)	1
KS33/134	KR33/258, KR33/274, KR33/82 (solo per/only for: 33/3011SDDF2)	1

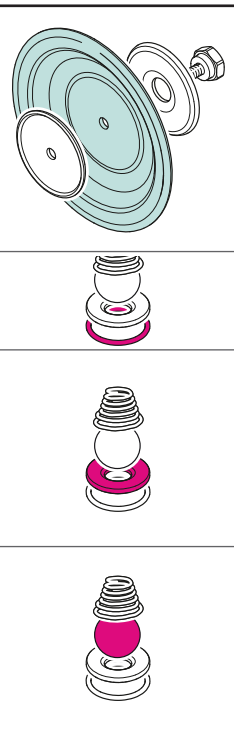



Art. 3C3/2611NHH2 Mod. AAB-1M-N-170 - Art. 3C3/2611TTP2 Mod. AAB-1M-T-150
 Art. 3C3/2611HHH2 Mod. AAB-1M-H-170 - Art. 3C3/2611EAA2 Mod. AAB-1M-E-170
 Art. 3C3/2611SSS2 Mod. AAB-1M-S-170



VISTA ESPLOSA - EXPLODED VIEW

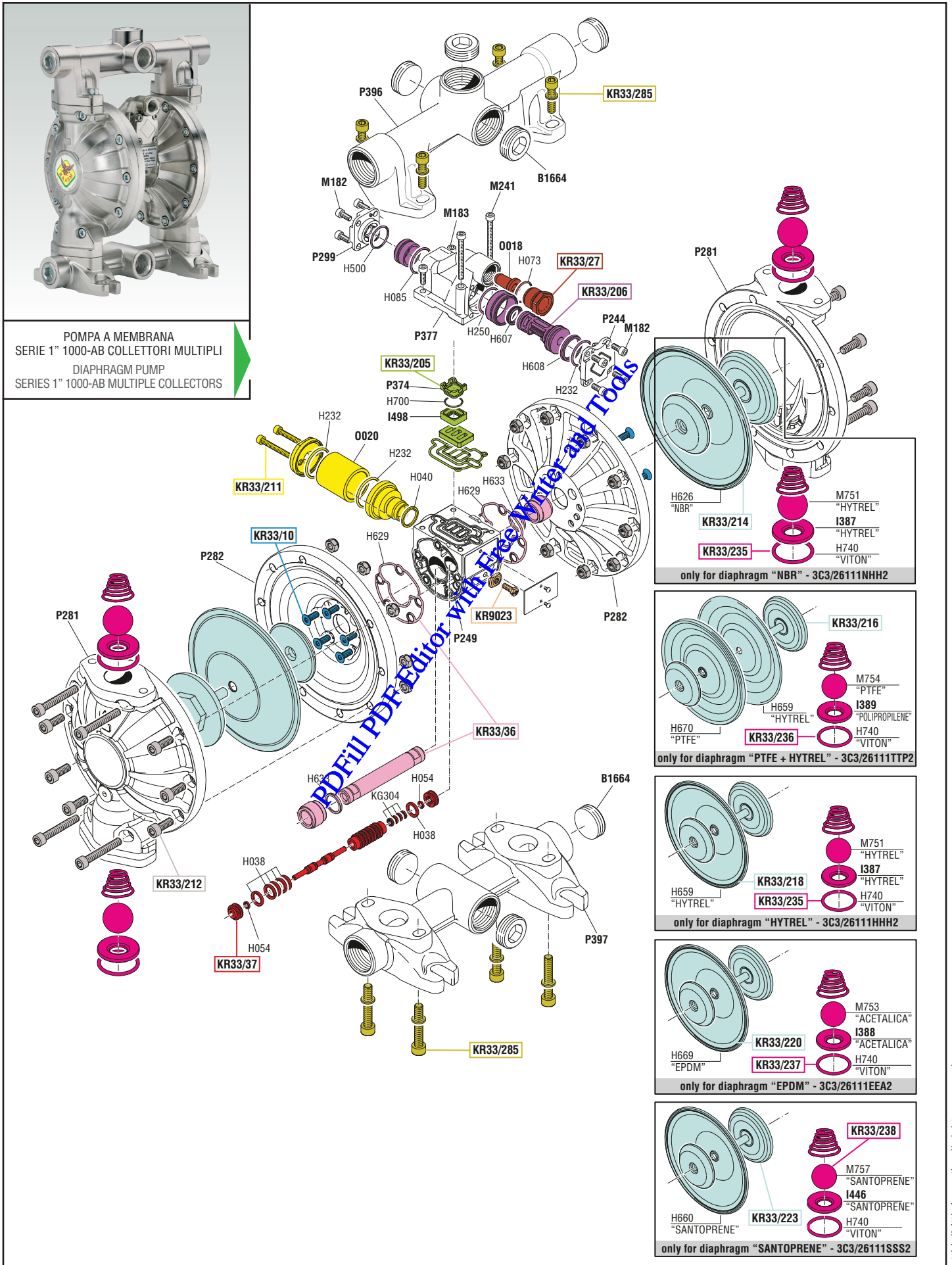

tutti i diritti riservati - all rights reserved

GUIDA RICAMBI - SPARE PARTS GUIDE

KIT RICAMBI OGNI KIT SOTTO RIPORTATO COMPRENDE I RICAMBI EVIDENZIATI CON LO STESSO COLORE E LE RELATIVE GUARNIZIONI. QUESTI RICAMBI NON SONO FORNIBILI SEPARATAMENTE TRANNE QUELLI CODIFICATI. SPARE PARTS KITS EACH KIT SHOWN WITH THE SAME COLOR INCLUDES ALSO THE GASKETS. THE SPARE PARTS INCLUDED IN THE KIT CAN'T BE SUPPLIED SEPARATELY EXCEPT THOSE SHOWN WITH A PROPER CODE.		
CODICE CODE	DESCRIZIONE DESCRIPTION	Q.TÀ QTY
KR33/214	GRUPPO MEMBRANE "NBR" DIAPHRAGM GROUP "NBR"	1
KR33/216	GRUPPO MEMBRANE "PTFE + HYTREL" DIAPHRAGM GROUP "PTFE + HYTREL"	1
KR33/218	GRUPPO MEMBRANE "HYTREL" DIAPHRAGM GROUP "HYTREL"	1
KR33/220	GRUPPO MEMBRANE "EPDM" DIAPHRAGM GROUP "EPDM"	1
KR33/223	GRUPPO MEMBRANE "SANTOPRENE" DIAPHRAGM GROUP "SANTOPRENE"	1
KR33/235	GRUPPO VALVOLE (3C3/2611NHH2, 3C3/2611HHH2) VALVE GROUP (3C3/2611NHH2, 3C3/2611HHH2)	1
KR33/236	GRUPPO VALVOLE (solo per 3C3/2611TTP2) VALVE GROUP (only for 3C3/2611TTP2)	1
KR33/237	GRUPPO VALVOLE (solo per 3C3/2611EAA2) VALVE GROUP (only for 3C3/2611EAA2)	1
KR33/238	GRUPPO VALVOLE (solo per 3C3/2611SSS2) VALVE GROUP (only for 3C3/2611SSS2)	1
KR33/10	VITERIA MOTORE MOTOR SCREWS	1
KR33/27	ENTRATA ARIA AIR INLET	1
KR33/36	GRUPPO ALBERO PISTONE PISTON SHAFT GROUP	1
KR33/37	GRUPPO PERNO PILOTA PILOT PIN GROUP	1
KR33/205	GRUPPO DISTRIBUTORE DISTRIBUTOR KIT	1
KR33/206	GRUPPO INVERTITORE AIR SWITCH KIT	1
KR33/211	SILENZIATORE MUFFLER	1
KR33/212	VITERIA FLANGE FLANGES SCREWS	1
KR33/285	VITERIA COLLETTORI MANIFOLDS SCREWS	1
KR9023	MESSA A TERRA GROUNDED	1

ELENCORICAMBI FORNIBILI SINGOLARMENTE

LIST OF SPARE PARTS WHICH CAN BE SUPPLIED SEPARATELY

CODICE CODE	DESCRIZIONE DESCRIPTION	Q.TÀ QTY
B1664	TAPPO ESAGONO INCASSATO HEXAGON SOCKET CAP	7
H700	GUARNIZIONE DISTRIBUTORE MOTORE ENGINE GASKET DISTRIBUTOR	1
I498	PORTE INFERIORE DISTRIBUTORE MOTORE BOTTOM ENGINE DISTRIBUTOR	1
M182	VITE INOX M45x12 STAINLESS STEEL SCREW M45x12	8
M183	VITE INOX M5x16 STAINLESS STEEL SCREW M5x16	2
M241	VITE INOX M5x50 STAINLESS STEEL SCREW M5x50	2
0018	FILTRO ENTRATA INLET FILTER	1
0020	SILENZIATORE MUFFLER	1
P244	COPERCHIO COVER	1
P249	CORPO CENTRALE CENTRAL BODY	1
P281	FLANGIA ESTERNA EXTERNAL FLANGE	2
P282	FLANGIA INTERNA INTERNAL FLANGE	2
P299	COPERCHIO COVER	1
P374	PORTE SUPERIORE DISTRIBUTORE MOTORE TOP ENGINE DISTRIBUTOR	1
P377	CORPO DISTRIBUTORE AIR DISTRIBUTOR	1
P396	COLLETTORE SUPERIORE OUTLET MANIFOLD	1
P397	COLLETTORE INFERIORE INLET MANIFOLD	1
H626	MEMBRANA "NBR" DIAPHRAGM "NBR"	2
H659	MEMBRANA "HYTREL" DIAPHRAGM "HYTREL"	2
H660	MEMBRANA "SANTOPRENE" PLATE "SANTOPRENE"	2
H669	MEMBRANA "EPDM" DIAPHRAGM "EPDM"	2
H670	MEMBRANA "PTFE" DIAPHRAGM "PTFE"	2
H740	GUARNIZIONE O-RING "VITON" O-RING "VITON"	4
I387	SEDE VALVOLA "HYTREL" SEAT VALVE "HYTREL"	4
I388	SEDE VALVOLA "ACETALICA" SEAT VALVE "ACETALICA"	4
I389	SEDE VALVOLA "POLIPROPILENE" SEAT VALVE "POLIPROPILENE"	4
I446	SEDE VALVOLA "SANTOPRENE" SEAT VALVE "SANTOPRENE"	4
M751	SFERA VALVOLA "HYTREL" BALL VALVE "HYTREL"	4
M753	SFERA VALVOLA "ACETALICA" BALL VALVE "ACETALICA"	4
M754	SFERA VALVOLA "PTFE" BALL VALVE "PTFE"	4
M757	SFERA VALVOLA "SANTOPRENE" BALL VALVE "SANTOPRENE"	4

KIT COMPLETO TUTTE LE GUARNIZIONI (H...) MENZIONATE NELL'ESPLOSO SONO FORNIBILI ANCHE SINGOLARMENTE

COMPLETE KIT ALL THE O-RING (H...) MENTIONED IN THE EXPLODED VIEW CAN BE SUPPLIED SEPARATELY

CODICE CODE	DESCRIZIONE DESCRIPTION	Q.TÀ QTY
KR33/209	KIT GUARNIZIONI DISTRIBUTORE ARIA AIR DISTRIBUTOR GASKETS KIT	1
KR33/234	KIT GUARNIZIONI CORPO MOTORE MOTOR GASKETS KIT	1
KR33/239	KIT MEMBRANE + VALVOLE (solo per 3C3/2611NHH2) DIAPHRAGM + VALVE KIT (only for 3C3/2611NHH2)	1
KR33/240	KIT MEMBRANE + VALVOLE (solo per 3C3/2611TTP2) DIAPHRAGM + VALVE KIT (only for 3C3/2611TTP2)	1
KR33/241	KIT MEMBRANE + VALVOLE (solo per 3C3/2611EAA2) DIAPHRAGM + VALVE KIT (only for 3C3/2611EAA2)	1
KR33/242	KIT MEMBRANE + VALVOLE (solo per 3C3/2611SSS2) DIAPHRAGM + VALVE KIT (only for 3C3/2611SSS2)	1
KR33/243	KIT MEMBRANE + VALVOLE (solo per 3C3/2611HHH2) DIAPHRAGM + VALVE KIT (only for 3C3/2611HHH2)	1

SET RICAMBI CONSIGLIATI
AI PUNTI VENDITA E ASSISTENZA, COMPOSTO DAI RICAMBI SOTTO ELENCATI
SPARE PARTS KIT ADVISED
TO THE REPAIR CENTERS. THIS KIT INCLUDES ALL THE SPARE PARTS SHOWN HERE UNDER

CODICE CODE	DESCRIZIONE DESCRIPTION	Q.TÀ QTY
KS33/110	KR33/209, KR33/234, KR33/239 (solo per/only for: 3C3/2611NHH2)	1
KS33/111	KR33/209, KR33/234, KR33/241 (solo per/only for: 3C3/2611EAA2)	1
KS33/112	KR33/209, KR33/234, KR33/240 (solo per/only for: 3C3/2611TTP2)	1
KS33/113	KR33/209, KR33/234, KR33/242 (solo per/only for: 3C3/2611SSS2)	1
KS33/114	KR33/209, KR33/234, KR33/243 (solo per/only for: 3C3/2611HHH2)	1

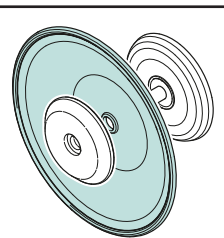

RAASM

FLUIDS AND LUBRICATION EQUIPMENT



Art. 2B3/16117NH22 Mod. PB-12-N-6060 - Art. 2B3/16117HH22 Mod. PB-12-H-6060
 Art. 2B3/16117EA12 Mod. PB-12-E-6060 - Art. 2B3/16117SS22 Mod. PB-12-S-6060
 Art. 2B3/16117TT22 Mod. PB-12-T-5060



VISTA ESPLOSA - EXPLODED VIEW



POMPA A MEMBRANA
 SERIE 1/2" 120-PB
 DIAPHRAGM PUMP
 SERIES 1/2" 120-PB

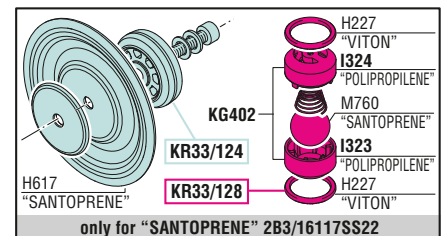
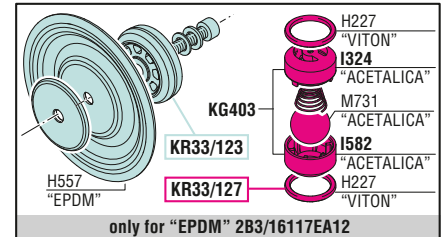
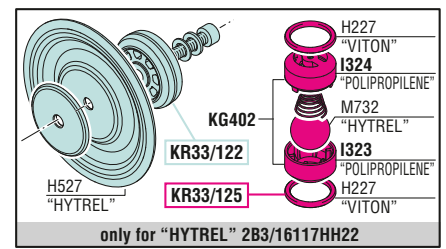
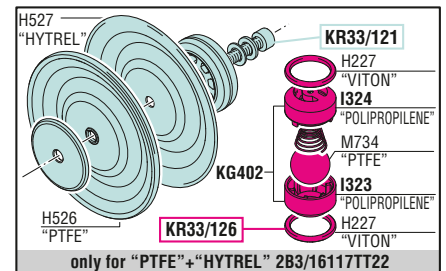
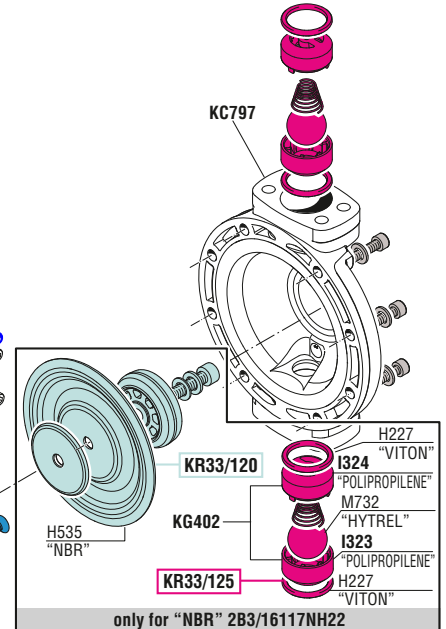
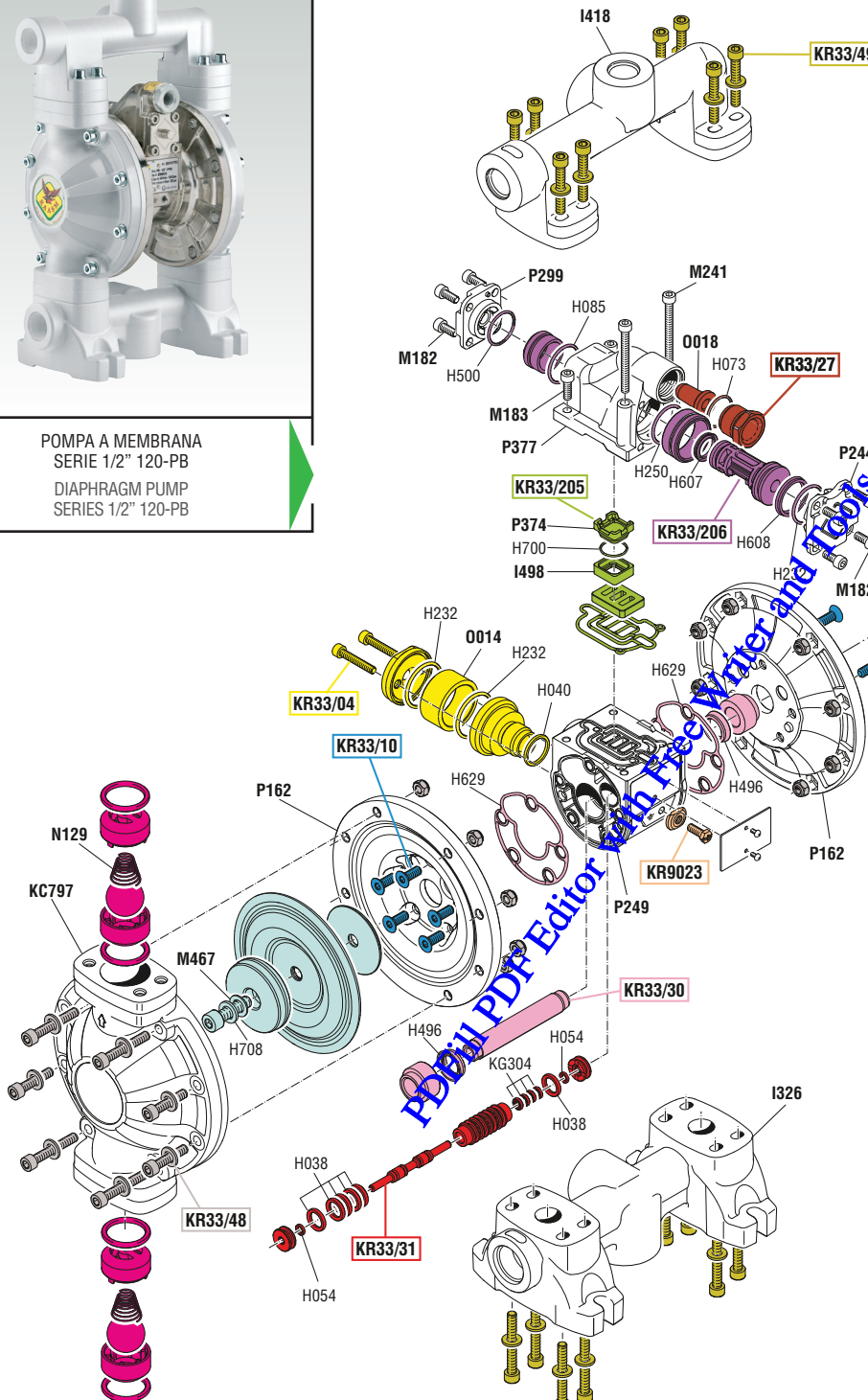

tutti i diritti riservati - all rights reserved

GUIDA RICAMBI - SPARE PARTS GUIDE

KIT RICAMBI OGNI KIT SOTTO RIPORTATO COMPRENDE I RICAMBI EVIDENZIATI CON LO STESSO COLORE E LE RELATIVE GUARNIZIONI. QUESTI RICAMBI NON SONO FORNIBILI SEPARATAMENTE TRANNE QUELLI CODIFICATI. SPARE PARTS KITS EACH KIT SHOWN WITH THE SAME COLOR INCLUDES ALSO THE GASKETS. THE SPARE PARTS INCLUDED IN THE KIT CAN'T BE SUPPLIED SEPARATELY EXCEPT THOSE SHOWN WITH A PROPER CODE.		
CODICE CODE	DESCRIZIONE DESCRIPTION	Q.TÀ QTY
KR33/120	GRUPPO MEMBRANE "NBR" DIAPHRAGM GROUP "NBR"	1
KR33/121	GRUPPO MEMBRANE "PTFE + HYTREL" DIAPHRAGM GROUP "PTFE + HYTREL"	1
KR33/122	GRUPPO MEMBRANE "HYTREL" DIAPHRAGM GROUP "HYTREL"	1
KR33/123	GRUPPO MEMBRANE "EPDM" DIAPHRAGM GROUP "EPDM"	1
KR33/124	GRUPPO MEMBRANE "SANTOPRENE" DIAPHRAGM GROUP "SANTOPRENE"	1
KR33/125	GRUPPO VALVOLE (2B3/16117NH22, 2B3/16117HH22) VALVE GROUP (2B3/16117NH22, 2B3/16117HH22)	1
KR33/126	GRUPPO VALVOLE (solo per 2B3/16117TT22) VALVE GROUP (only for 2B3/16117TT22)	1
KR33/127	GRUPPO VALVOLE (solo per 2B3/16117EA12) VALVE GROUP (only for 2B3/16117EA12)	1
KR33/128	GRUPPO VALVOLE (solo per 2B3/16117SS22) VALVE GROUP (only for 2B3/16117SS22)	1
KR33/04	SILENZIATORE MUFFLER	1
KR33/10	VITERIA MOTORE MOTOR SCREWS	1
KR33/27	ENTRATA ARIA AIR INLET	1
KR33/30	GRUPPO ALBERO PISTONE PISTON SHAFT GROUP	1
KR33/31	GRUPPO PERNO PILOTA PILOT PIN GROUP	1
KR33/48	VITERIA FLANGE FLANGES SCREWS	1
KR33/49	VITERIA COLLETTORI MANIFOLDS SCREWS	1
KR33/205	GRUPPO DISTRIBUTORE DISTRIBUTOR KIT	1
KR33/206	GRUPPO INVERTITORE AIR SWITCH KIT	1
KR9023	MESSA A TERRA GROUNDED	1

ELENCORICAMBIFORNIBILISINGOLARMENTE

LIST OF SPARE PARTS WHICH CAN BE SUPPLIED SEPARATELY

CODICE CODE	DESCRIZIONE DESCRIPTION	Q.TÀ QTY
H700	GUARNIZIONE DISTRIBUTORE MOTORE ENGINE GASKET DISTRIBUTOR	1
H708	GUARNIZIONE IN "PVDF" "PVDF" GASKET	2
I326	COLLETTORE INFERIORE INLET MANIFOLD	1
I418	COLLETTORE SUPERIORE OUTLET MANIFOLD	1
I498	PARTI INFERIORE DISTRIBUTORE MOTORE BOTTOM ENGINE DISTRIBUTOR	1
KC797	FLANGIA ESTERNA EXTERNAL FLANGE	2
M182	VITE INOX M45x12 STAINLESS STEEL SCREW M45x12	8
M183	VITE INOX M5x16 STAINLESS STEEL SCREW M5x16	2
M241	VITE INOX M5x50 STAINLESS STEEL SCREW M5x50	2
M467	RONDELLA INOX STEEL WASHER	2
O014	SILENZIATORE MUFFLER	1
O018	FILTRO ENTRATA INLET FILTER	1
P162	FLANGIA INTERNA INTERNAL FLANGE	2
P244	COPERCHIO COVER	1
P249	CORPO CENTRALE CENTRAL BODY	1
P299	COPERCHIO COVER	1
P374	PARTI SUPERIORE DISTRIBUTORE MOTORE TOP ENGINE DISTRIBUTOR	1
P377	CORPO DISTRIBUTORE AIR DISTRIBUTOR BODY	1
H526	MEMBRANA "PTFE" DIAPHRAGM "PTFE"	2
H527	MEMBRANA "HYTREL" DIAPHRAGM "HYTREL"	2
H535	MEMBRANA "NBR" DIAPHRAGM "NBR"	2
H557	MEMBRANA "EPDM" DIAPHRAGM "EPDM"	2
H617	MEMBRANA "SANTOPRENE" DIAPHRAGM "SANTOPRENE"	2
H227	GUARNIZIONE O-RING 134 "VITON" O-RING 134 "VITON"	8
KG402	INSERTO INFERIORE/SUPERIORE IN "POLIPROPILENE" INSERT LOWER/UPPER IN "POLYPROPYLENE"	4
KG403	INSERTO INFERIORE/SUPERIORE IN "ACETALICA" INSERT LOWER/UPPER IN "ACETALICA"	4
M731	SFERA VALVOLA "ACETALICA" BALL VALVE "ACETALICA"	4
M732	SFERA VALVOLA "HYTREL" BALL VALVE "HYTREL"	4
M734	SFERA VALVOLA "PTFE" BALL VALVE "PTFE"	4
M760	SFERA VALVOLA "SANTOPRENE" BALL VALVE "SANTOPRENE"	4

KIT COMPLETO
TUTTE LE GUARNIZIONI (H...) MENZIONATE NELL'ESPLOSO SONO FORNIBILI ANCHE SINGOLARMENTE

COMPLETE KIT

ALL THE O-RING (H...) MENTIONED IN THE EXPLODED VIEW CAN BE SUPPLIED SEPARATELY

CODICE CODE	DESCRIZIONE DESCRIPTION	Q.TÀ QTY
KR33/209	KIT GUARNIZIONI DISTRIBUTORE ARIA AIR DISTRIBUTOR GASKETS KIT	1
KR33/210	KIT GUARNIZIONI CORPO MOTORE MOTOR GASKETS KIT	1
KR33/275	KIT MEMBRANA + VALVOLE (solo per 2B3/16117NH22) DIAPHRAGM + VALVE KIT (only for 2B3/16117NH22)	1
KR33/276	KIT MEMBRANA + VALVOLE (solo per 2B3/16117TT22) DIAPHRAGM + VALVE KIT (only for 2B3/16117TT22)	1
KR33/277	KIT MEMBRANA + VALVOLE (solo per 2B3/16117HH22) DIAPHRAGM + VALVE KIT (only for 2B3/16117HH22)	1
KR33/278	KIT MEMBRANA + VALVOLE (solo per 2B3/16117EA12) DIAPHRAGM + VALVE KIT (only for 2B3/16117EA12)	1
KR33/279	KIT MEMBRANA + VALVOLE (solo per 2B3/16117SS22) DIAPHRAGM + VALVE KIT (only for 2B3/16117SS22)	1

SET RICAMBI CONSIGLIATI

AI PUNTI VENDITA E ASSISTENZA. COMPOSTO DAI RICAMBI SOTTO ELENCATI

SPARE PARTS KIT ADVISED

TO THE REPAIR CENTERS. THIS KIT INCLUDES ALL THE SPARE PARTS SHOWN HERE UNDER

CODICE CODE	DESCRIZIONE DESCRIPTION	Q.TÀ QTY
KS33/140	KR33/209, KR33/210, KR33/275 (solo per/only for: 2B3/16117NH22)	1
KS33/141	KR33/209, KR33/210, KR33/276 (solo per/only for: 2B3/16117TT22)	1
KS33/142	KR33/209, KR33/210, KR33/277 (solo per/only for: 2B3/16117HH22)	1
KS33/143	KR33/209, KR33/210, KR33/278 (solo per/only for: 2B3/16117EA12)	1
KS33/144	KR33/209, KR33/210, KR33/279 (solo per/only for: 2B3/16117SS22)	1

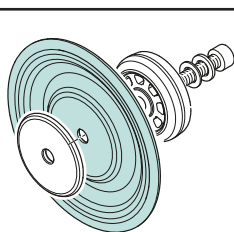



Art. 2B8/16117NH22 Mod. PB-12-N-30E3060 - Art. 2B8/16117HH22 Mod. PB-12-H-30E3060
Art. 2B8/16117EA12 Mod. PB-12-E-30E3060 - Art. 2B8/16117SS22 Mod. PB-12-S-30E3060
Art. 2B8/16117TT22 Mod. PB-12-T-25E2560



VISTA ESPLOSA - EXPLODED VIEW



POMPA A MEMBRANA
SERIE 1/2" 120-PB
DIAPHRAGM PUMP
SERIES 1/2" 120-PB

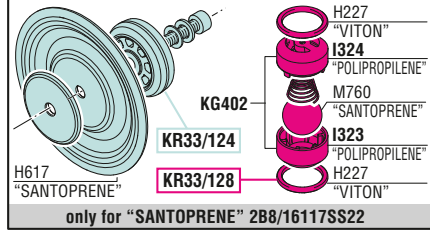
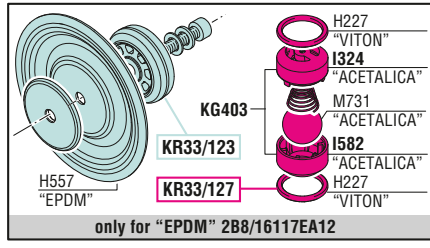
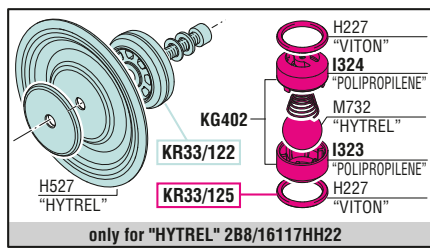
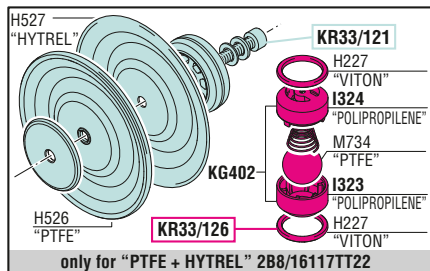
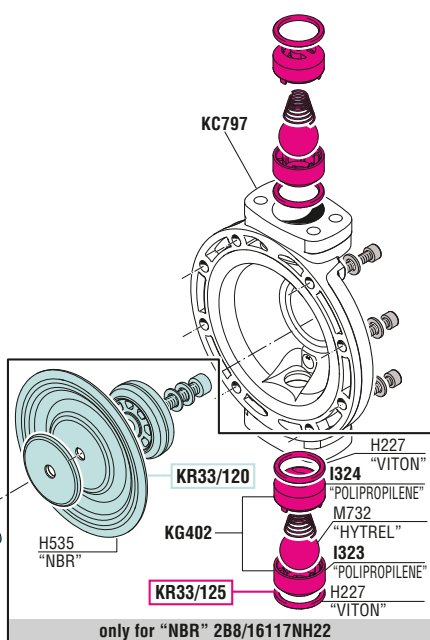
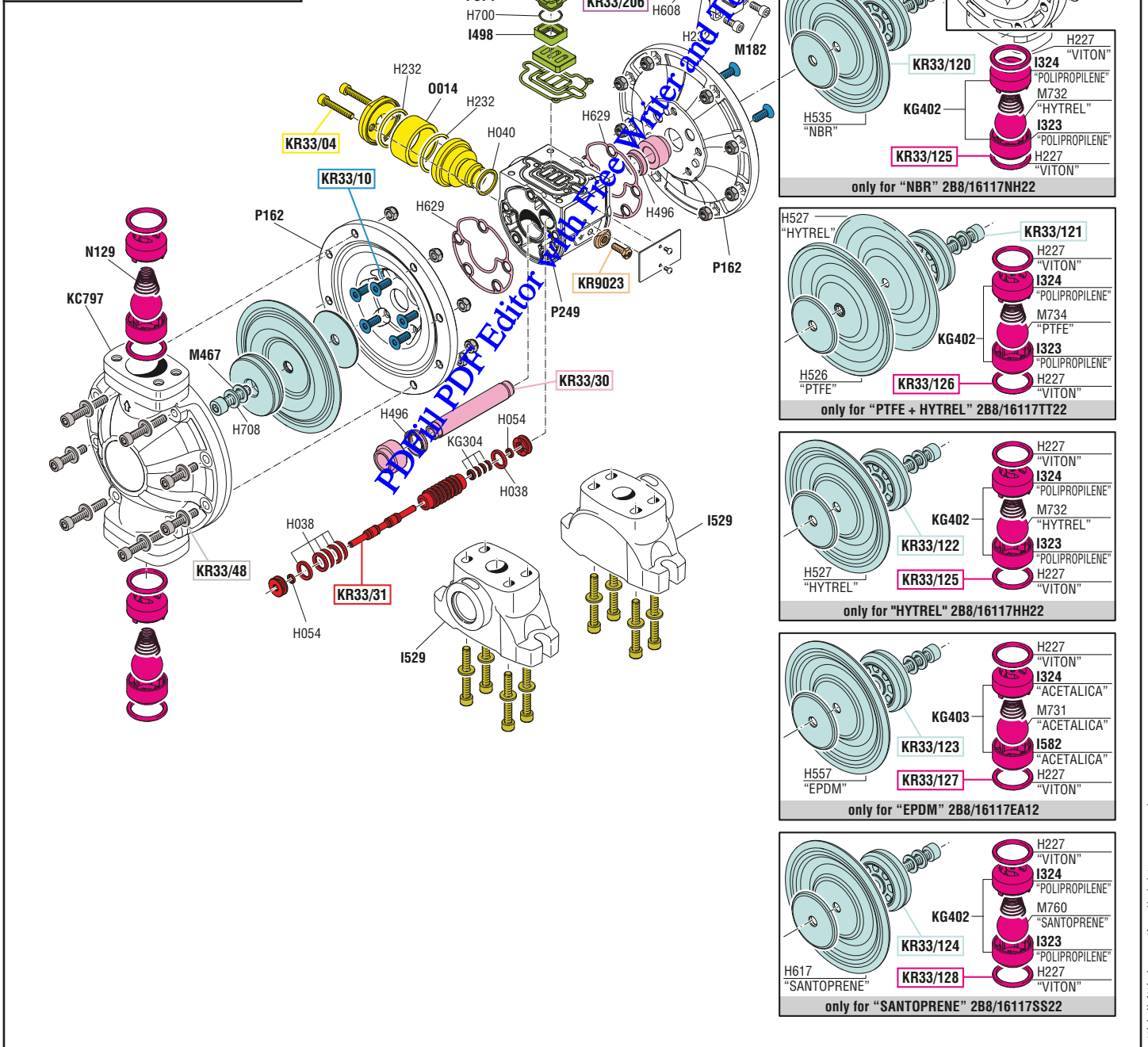

tutti i diritti riservati - all rights reserved

GUIDA RICAMBI - SPARE PARTS GUIDE

KIT RICAMBI OGNI KIT SOTTO RIPORTATO COMPRENDE I RICAMBI EVIDENZIATI CON LO STESSO COLORE E LE RELATIVE GUARNIZIONI. QUESTI RICAMBI NON SONO FORNIBILI SEPARATAMENTE TRANNE QUELLI CODIFICATI. SPARE PARTS KITS EACH KIT SHOWN WITH THE SAME COLOR INCLUDES ALSO THE GASKETS. THE SPARE PARTS INCLUDED IN THE KIT CAN'T BE SUPPLIED SEPARATELY EXCEPT THOSE SHOWN WITH A PROPER CODE.		
CODICE CODE	DESCRIZIONE DESCRIPTION	Q.TÀ QTY
KR33/120	GRUPPO MEMBRANE "NBR" DIAPHRAGM GROUP "NBR"	1
KR33/121	GRUPPO MEMBRANE "PTFE + HYTREL" DIAPHRAGM GROUP "PTFE + HYTREL"	1
KR33/122	GRUPPO MEMBRANE "HYTREL" DIAPHRAGM GROUP "HYTREL"	1
KR33/123	GRUPPO MEMBRANE "EPDM" DIAPHRAGM GROUP "EPDM"	1
KR33/124	GRUPPO MEMBRANE "SANTOPRENE" DIAPHRAGM GROUP "SANTOPRENE"	1
KR33/125	GRUPPO VALVOLE (288/16117NH22, 288/16117HH22) VALVE GROUP (288/16117NH22, 288/16117HH22)	1
KR33/126	GRUPPO VALVOLE (solo per 288/16117TT22) VALVE GROUP (only for 288/16117TT22)	1
KR33/127	GRUPPO VALVOLE (solo per 288/16117EA12) VALVE GROUP (only for 288/16117EA12)	1
KR33/128	GRUPPO VALVOLE (solo per 288/16117SS22) VALVE GROUP (only for 288/16117SS22)	1
KR33/04	SILENZIATORE MUFFLER	1
KR33/10	VITERIA MOTORE MOTOR SCREWS	1
KR33/27	ENTRATA ARIA AIR INLET	1
KR33/30	GRUPPO ALBERO PISTONE PISTON SHAFT GROUP	1
KR33/31	GRUPPO PERNO PILOTA PILOT PIN GROUP	1
KR33/48	VITERIA FLANGE FLANGES SCREWS	1
KR33/49	VITERIA COLLETTORI MANIFOLDS SCREWS	1
KR33/205	GRUPPO DISTRIBUTORE DISTRIBUTOR KIT	1
KR33/206	GRUPPO INVERTITORE AIR SWITCH KIT	1
KR9023	MESSA A TERRA GROUNDED	1

ELENCORICAMBI FORNIBILI SINGOLARMENTE

LIST OF SPARE PARTS WHICH CAN BE SUPPLIED SEPARATELY

CODICE CODE	DESCRIZIONE DESCRIPTION	Q.TÀ QTY
H700	GUARNIZIONE DISTRIBUTORE MOTORE ENGINE GASKET DISTRIBUTOR	1
H708	GUARNIZIONE IN "PVDF" "PVDF" GASKET	2
I418	COLLETTORE SUPERIORE OUTLET MANIFOLD	1
I498	PARTE INFERIORE DISTRIBUTORE MOTORE BOTTOM ENGINE DISTRIBUTOR	1
I529	COLLETTORE INFERIORE INLET MANIFOLD	2
KC797	FLANGIA ESTERNA EXTERNAL FLANGE	2
M182	VITE INOX M45x12 STAINLESS STEEL SCREW M45x12	8
M183	VITE INOX M5x16 STAINLESS STEEL SCREW M5x16	2
M241	VITE INOX M5x50 STAINLESS STEEL SCREW M5x50	2
M467	RONDELLA INOX STEEL WASHER	2
0014	SILENZIATORE MUFFLER	1
0018	FILTRO ENTRATA INLET FILTER	1
P162	FLANGIA INTERNA INTERNAL FLANGE	2
P244	COPERCHIO COVER	1
P249	CORPO CENTRALE CENTRAL BODY	1
P299	COPERCHIO COVER	1
P374	PARTE SUPERIORE DISTRIBUTORE MOTORE TOP ENGINE DISTRIBUTOR	1
P377	CORPO DISTRIBUTORE AIR DISTRIBUTOR BODY	1
H526	MEMBRANA "PTFE" DIAPHRAGM "PTFE"	2
H527	MEMBRANA "HYTREL" DIAPHRAGM "HYTREL"	2
H535	MEMBRANA "NBR" DIAPHRAGM "NBR"	2
H557	MEMBRANA "EPDM" DIAPHRAGM "EPDM"	2
H617	MEMBRANA "SANTOPRENE" DIAPHRAGM "SANTOPRENE"	2
H227	GUARNIZIONE O-RING 134 "VITON" O-RING 134 "VITON"	8
KG402	INSERTO INFERIORE/SUPERIORE IN "POLIPROPILENE" INSERT LOWER/UPPER IN "POLYPROPYLENE"	4
KG403	INSERTO INFERIORE/SUPERIORE IN "ACETALICA" INSERT LOWER/UPPER IN "ACETALICA"	4
M731	SFERA VALVOLA "ACETALICA" BALL VALVE "ACETALICA"	4
M732	SFERA VALVOLA "HYTREL" BALL VALVE "HYTREL"	4
M734	SFERA VALVOLA "PTFE" BALL VALVE "PTFE"	4
M760	SFERA VALVOLA "SANTOPRENE" BALL VALVE "SANTOPRENE"	4

KIT COMPLETO TUTTE LE GUARNIZIONI (H...) MENZIONATE NELL'ESPLOSO SONO FORNIBILI ANCHE SINGOLARMENTE

COMPLETE KIT

ALL THE O-RING (H...) MENTIONED IN THE EXPLODED VIEW CAN BE SUPPLIED SEPARATELY

CODICE CODE	DESCRIZIONE DESCRIPTION	Q.TÀ QTY
KR33/209	KIT GUARNIZIONI DISTRIBUTORE ARIA AIR DISTRIBUTOR GASKETS KIT	1
KR33/210	KIT GUARNIZIONI CORPO MOTORE MOTOR GASKETS KIT	1
KR33/275	KIT MEMBRANE + VALVOLE (solo per 288/16117NH22) DIAPHRAGM + VALVE KIT (only for 288/16117NH22)	1
KR33/276	KIT MEMBRANE + VALVOLE (solo per 288/16117TT22) DIAPHRAGM + VALVE KIT (only for 288/16117TT22)	1
KR33/277	KIT MEMBRANE + VALVOLE (solo per 288/16117HH22) DIAPHRAGM + VALVE KIT (only for 288/16117HH22)	1
KR33/278	KIT MEMBRANE + VALVOLE (solo per 288/16117EA12) DIAPHRAGM + VALVE KIT (only for 288/16117EA12)	1
KR33/279	KIT MEMBRANE + VALVOLE (solo per 288/16117SS22) DIAPHRAGM + VALVE KIT (only for 288/16117SS22)	1

SET RICAMBI CONSIGLIATI

AI PUNTI VENDITA E ASSISTENZA, COMPOSTO DAI RICAMBI SOTTO ELENCATI

SPARE PARTS KIT ADVISED

TO THE REPAIR CENTERS. THIS KIT INCLUDES ALL THE SPARE PARTS SHOWN HERE UNDER

CODICE CODE	DESCRIZIONE DESCRIPTION	Q.TÀ QTY
KS33/140	KR33/209, KR33/210, KR33/275 (solo per/only for: 288/16117NH22)	1
KS33/141	KR33/209, KR33/210, KR33/276 (solo per/only for: 288/16117TT22)	1
KS33/142	KR33/209, KR33/210, KR33/277 (solo per/only for: 288/16117HH22)	1
KS33/143	KR33/209, KR33/210, KR33/278 (solo per/only for: 288/16117EA12)	1
KS33/144	KR33/209, KR33/210, KR33/279 (solo per/only for: 288/16117SS22)	1

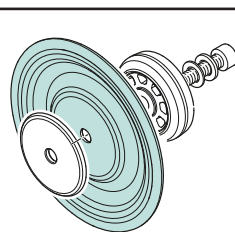



Art. 33016 Mod. DO.P. 16L

VISTA ESPLOSA - EXPLODED VIEW



DISTRIBUTORE PNEUMATICO D'OLIO CON SERBATOIO PORTATILE DA 16 l
PORTABLE AIR OPERATED OIL DISPENSER WITH 16 l TANK

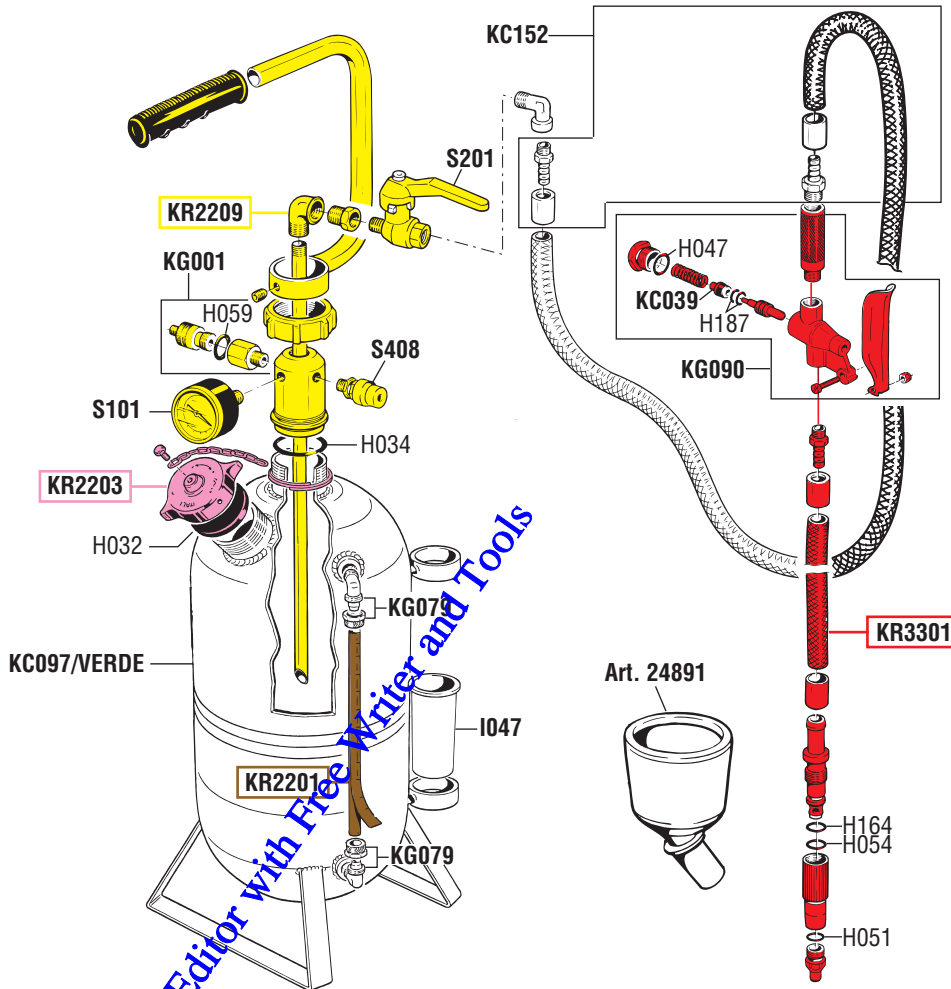

GUIDA RICAMBI - SPARE PARTS GUIDE

KIT RICAMBI
OGNI KIT SOTTO RIPORTATO COMPRENDE I RICAMBI EVIDENZIATI CON LO STESSO COLORE E LE RELATIVE GUARNIZIONI. QUESTI RICAMBI NON SONO FORNIBILI SEPARATAMENTE TRANNE QUELLI CODIFICATI.

SPARE PARTS KITS
EACH KIT SHOWN WITH THE SAME COLOR INCLUDES ALSO THE GASKETS. THE SPARE PARTS INCLUDED IN THE KIT CAN'T BE SUPPLIED SEPARATELY EXCEPT THOSE SHOWN WITH A PROPER CODE.

CODICE CODE	DESCRIZIONE DESCRIPTION	Q.TÀ QTY
KR2201	TUBO DI LIVELLO ED ETICHETTA GAUGE TUBE AND LABEL	1
KR2203	TAPPO ALTA PRESSIONE HIGH PRESSURE PLUG	1
KR2209	GRUPPO SUPERIORE SERBATOIO UPPER GROUP FOR RESERVOIR	1
KR3301	PISTOLA EROGATRICE DELIVERY GUN	1

ELENCO RICAMBI FORNIBILI SINGOLARMENTE
LIST OF SPARE PARTS WHICH CAN BE SUPPLIED SEPARATELY

CODICE CODE	DESCRIZIONE DESCRIPTION	Q.TÀ QTY
24891	IMBUTO FUNNEL	1
I047	BICCHIERE RACCOGLIGOCCE DRIP COLLECTOR	1
KC097/VERDE	SERBATOIO 16 l RESERVOIR 16 l	1
KC152	PROLUNGA EXTENSION	1
KG001	RUBINETTO UNIVERSALE CARICA ARIA UNIVERSAL AIR TAP	1
KG079	GRUPPO GOMITO E GHIERA RING AND ELBOW JOINT GROUP	2
KG090	IMPUGNATURA PISTOLA GUN GRIP	1
S101	MANOMETRO ø 50 mm GAUGE ø 50 mm	1
S201	RUBINETTO A SFERA 1/4" BALL VALVE 1/4"	1
S408	VALVOLA SICUREZZA 10 bar SAFETY VALVE 10 bar	1

Art. KR3350 **KIT GUARNIZIONI COMPLETO**
COMPOSTO DALLE GUARNIZIONI SOTTO ELENCAE
JOINTS GASKETS LIST
INCLUDING ALL THE GASKETS SHOWN HERE UNDER

CODICE CODE	DESCRIZIONE DESCRIPTION	Q.TÀ QTY
H032	GUARNIZIONE TAPPO GASKET	1
H034	O-RING 3156 O-RING 3156	1
H047	O-RING 2050 O-RING 2050	1
H051	O-RING 2031 O-RING 2031	1
H054	O-RING 2018 O-RING 2018	1
H059	O-RING 2037 O-RING 2037	1
H164	O-RING 108 O-RING 108	1
H187	O-RING 2021 "VITON" O-RING 2021 "VITON"	2
KC039	VALVOLA VULCANIZZATA PISTOLA OLIO OIL VULCANIZED VALVE	1

Art. KS3380 **SET RICAMBI CONSIGLIATI**
AI PUNTI VENDITA E ASSISTENZA,
COMPOSTO DAI RICAMBI SOTTO ELENCAE
SPARE PARTS KIT ADVISED
TO THE REPAIR CENTERS. THIS KIT INCLUDES
ALL THE SPARE PARTS SHOWN HERE UNDER

CODICE CODE	DESCRIZIONE DESCRIPTION	Q.TÀ QTY
KR3350	KIT GUARNIZIONI COMPLETO COMPLETE GASKETS KIT	1
S101	MANOMETRO ø 50 mm GAUGE ø 50 mm	1

tutti i diritti riservati - all rights reserved



Art. 33024 Mod. DO.P. 24L



VISTA ESPLOSA - EXPLODED VIEW

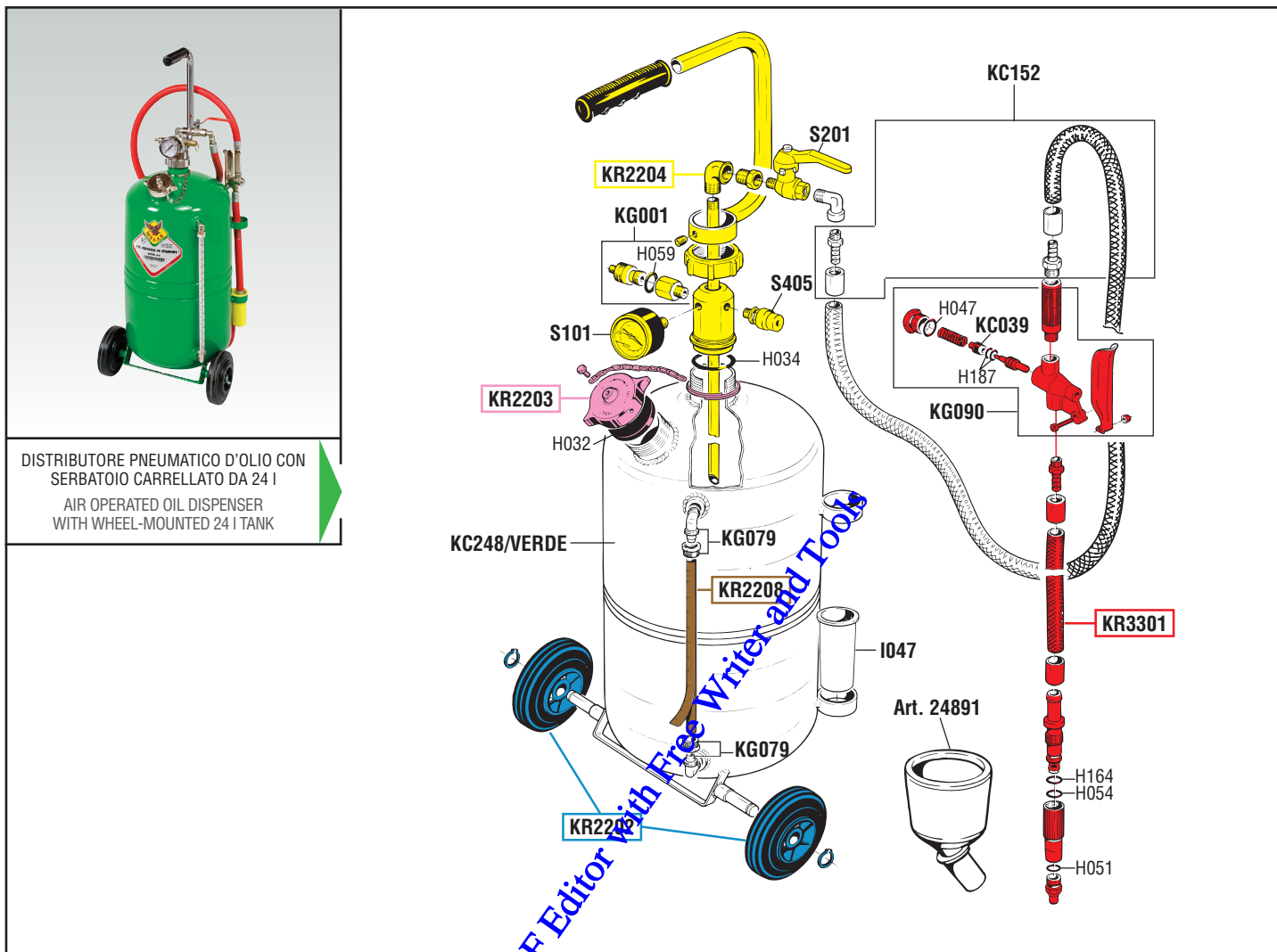

DISTRIBUTORE PNEUMATICO D'OLIO CON SERBATOIO CARRELLATO DA 24 l
AIR OPERATED OIL DISPENSER WITH WHEEL-MOUNTED 24 l TANK

GUIDA RICAMBI - SPARE PARTS GUIDE

KIT RICAMBI
OGNI KIT SOTTO RIPORTATO COMPRENDE I RICAMBI EVIDENZIATI CON LO STESSO COLORE E LE RELATIVE GUARNIZIONI. QUESTI RICAMBI NON SONO FORNIBILI SEPARATAMENTE TRANNE QUELLI CODIFICATI.

SPARE PARTS KITS
EACH KIT SHOWN WITH THE SAME COLOR INCLUDES ALSO THE GASKETS. THE SPARE PARTS INCLUDED IN THE KIT CAN'T BE SUPPLIED SEPARATELY EXCEPT THOSE SHOWN WITH A PROPER CODE.

CODICE CODE	DESCRIZIONE DESCRIPTION	Q.TÀ QTY
KR2202	DUE RUOTE CON ANELLI ELASTICI TWO FIXED WHEELS WITH RETAINING RINGS	1
KR2203	TAPPO ALTA PRESSIONE HIGH PRESSURE PLUG	1
KR2204	GRUPPO SUPERIORE SERBATOIO 24 l UPPER GROUP FOR 24 l RESERVOIR	1
KR2208	TUBO DI LIVELLO CON ETICHETTA GAUGE TUBE WITH LABEL	1
KR3301	PISTOLA EROGATRICE DELIVERY GUN	1

ELENCO RICAMBI FORNIBILI SINGOLARMENTE
LIST OF SPARE PARTS WHICH CAN BE SUPPLIED SEPARATELY

CODICE CODE	DESCRIZIONE DESCRIPTION	Q.TÀ QTY
24891	IMBUTO FUNNEL	1
I047	BICCHIERE RACCOGLIGOCCE DRIP COLLECTOR	1
KC152	PROLUNGA EXTENSION	1
KC248/VERDE	SERBATOIO 24 l RESERVOIR 24 l	1
KG001	RUBINETTO UNIVERSALE CARICA ARIA UNIVERSAL AIR TAP	1
KG079	GRUPPO GOMITO E GHIERA RING AND ELBOW JOINT GROUP	2
KG090	IMPUGNATURA PISTOLA GUN GRIP	1
S101	MANOMETRO ø 50 mm GAUGE ø 50 mm	1
S201	RUBINETTO A SFERA 1/4" BALL VALVE 1/4"	1
S405	VALVOLA SICUREZZA 8 bar SAFETY VALVE 8 bar	1

Art. KR3350
KIT GUARNIZIONI COMPLETO
COMPOSTO DALLE GUARNIZIONI SOTTO ELENCAE
JOINTS GASKETS LIST
INCLUDING ALL THE GASKETS SHOWN HERE UNDER

CODICE CODE	DESCRIZIONE DESCRIPTION	Q.TÀ QTY
H032	GUARNIZIONE TAPPO GASKET	1
H034	O-RING 3156 O-RING 3156	1
H047	O-RING 2050 O-RING 2050	1
H051	O-RING 2031 O-RING 2031	1
H054	O-RING 2018 O-RING 2018	1
H059	O-RING 2037 O-RING 2037	1
H164	O-RING 108 O-RING 108	1
H187	O-RING 2021 "VITON" O-RING 2021 "VITON"	2
KC039	VALVOLA VULCANIZZATA PISTOLA OLIO OIL VULCANIZED VALVE	1

Art. KS3380
SET RICAMBI CONSIGLIATI
AI PUNTI VENDITA E ASSISTENZA,
COMPOSTO DAI RICAMBI SOTTO ELENCAE
SPARE PARTS KIT ADVISED
TO THE REPAIR CENTERS. THIS KIT INCLUDES
ALL THE SPARE PARTS SHOWN HERE UNDER

CODICE CODE	DESCRIZIONE DESCRIPTION	Q.TÀ QTY
KR3350	KIT GUARNIZIONI COMPLETO COMPLETE GASKETS KIT	1
S101	MANOMETRO ø 50 mm GAUGE ø 50 mm	1

tutti i diritti riservati - all rights reserved



Art. 33060 Mod. 1:1/60E - Art. 33060/A Mod. 1:1/AE - Art. 33061 Mod. 1:1/60E
 Art. 33094 Mod. 1:1/94E - Art. 33096 Mod. 1:1/94E



VISTA ESPLOSA - EXPLODED VIEW

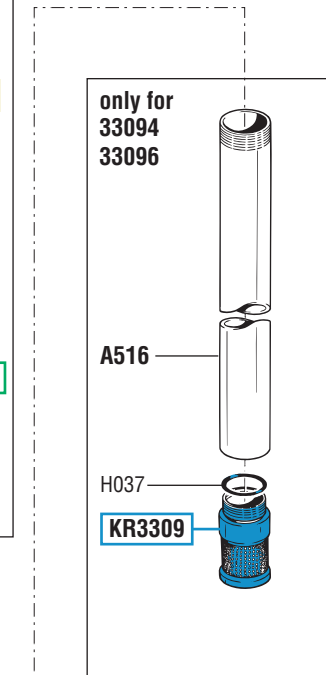
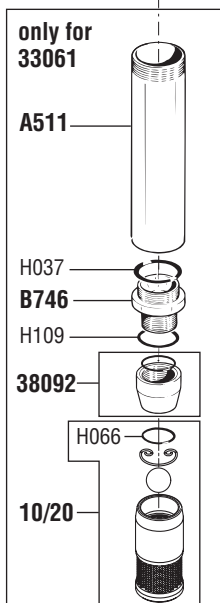
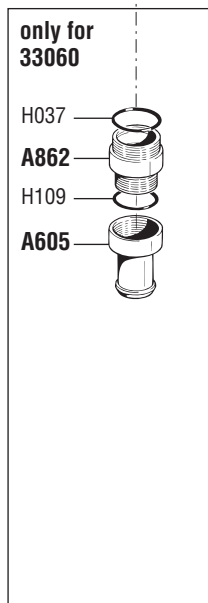
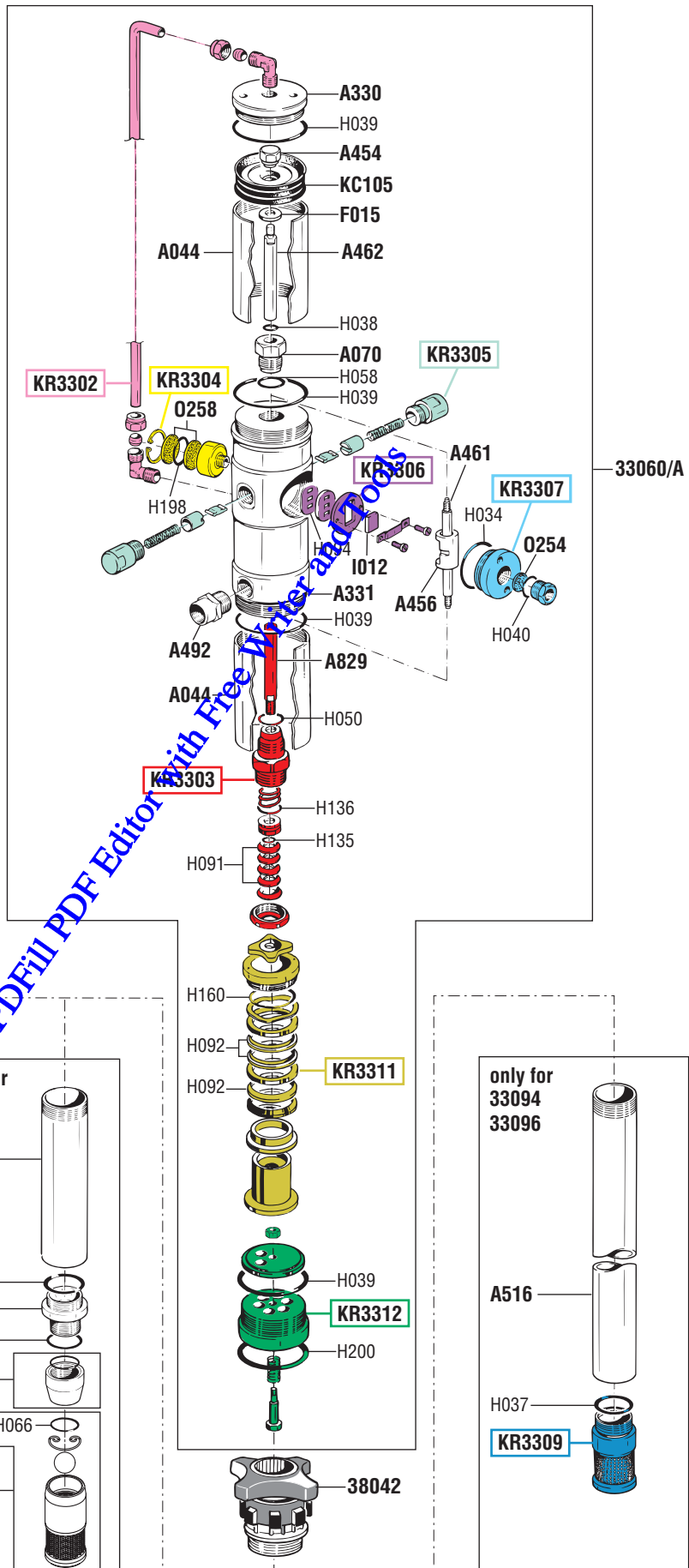
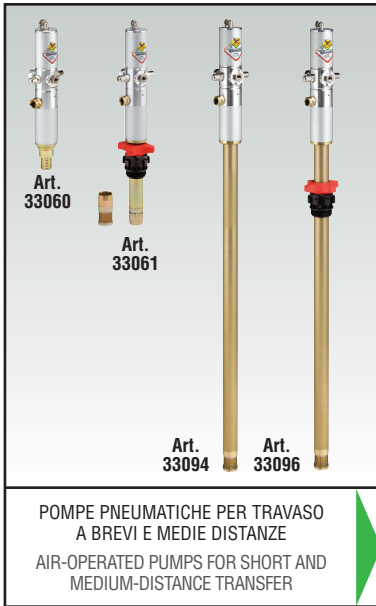

PDFFill PDF Editor With Free Water and Tools

GUIDA RICAMBI - SPARE PARTS GUIDE

KIT RICAMBI		
OGNI KIT SOTTO RIPORTATO COMPRENDE I RICAMBI EVIDENZIATI CON LO STESSO COLORE E LE RELATIVE GUARNIZIONI. QUESTI RICAMBI NON SONO FORNIBILI SEPARATAMENTE TRANNE QUELLI CODIFICATI.		
SPARE PARTS KITS		
EACH KIT SHOWN WITH THE SAME COLOR INCLUDES ALSO THE GASKETS. THE SPARE PARTS INCLUDED IN THE KIT CAN'T BE SUPPLIED SEPARATELY EXCEPT THOSE SHOWN WITH A PROPER CODE.		
CODICE CODE	DESCRIZIONE DESCRIPTION	Q.TÀ QTY
KR3302	TUBO RICICLO CON RACCORDI TUBE WITH CONNECTIONS	1
KR3303	PACCO GUARNIZIONI GASKETS KIT	1
KR3304	SILENZIATORE MUFFLER	1
KR3305	DOPPIO GRUPPO INVERTITORE DOUBLE PLUNGER GROUP	1
KR3306	GRUPPO DISTRIBUTORE D'ARIA SLIDE VALVE GROUP	1
KR3307	TAPPO ENTRATA ARIA AIR INLET CONNECTION	1
KR3309	FILTRO PESCANTE SHANK FILTER	1
KR3311	PISTONE ASPIRAZIONE SUCTION PISTON	1
KR3312	VALVOLA ASPIRAZIONE SUCTION VALVE	1

ELENCO RICAMBI FORNIBILI SINGOLARMENTE		
LIST OF SPARE PARTS WHICH CAN BE SUPPLIED SEPARATELY		
CODICE CODE	DESCRIZIONE DESCRIPTION	Q.TÀ QTY
A044	CILINDRO MOTORE MOTOR CYLINDER	2
A070	GUIDA STELO ROD GUIDE	1
A330	TESTA MOTORE MOTOR HEAD	1
A331	CORPO MOTORE POMPA PUMP MOTOR BODY	1
A454	DADO BLOCCA PISTONE NUT	1
A456	SPINGI INVERTITORE SHUTTLE	1
A461	ALBERO CENTRALE MOTORE MOTOR SPINDLE	1
A462	ALBERO PISTONE MOTORE MOTOR PISTON SPINDLE	1
A492	ADATTATORE M 1/2" G x F 1/2" G ADAPTOR M 1/2" G x F 1/2" G	1
A511	TUBO PESCANTE Art. 33061 SUCTION TUBE Art. 33061	1
A516	TUBO PESCANTE Art. 33094 - 33096 SUCTION TUBE Art. 33094 - 33096	1
A605	PORTATUBO A RESCA Art. 33060 HOSE HOLDER Art. 33060	1
A829	ALBERO INFERIORE LOWER SPINDLE	1
A862	RACCORDO Art. 33060 UNION Art. 33060	1
B746	PORTA VALVOLA FILETTATO Art. 33061 THREADED TUBE HOLDER Art. 33061	1
F015	RONDELLA WASHER	1
10/20	FILTRO VALVOLA PESCANTE FILETTATO 1" SHANK FILTER F 1"	1
38042	GHIERA DI BLOCCAGGIO ø 42 mm BUNG ADAPTOR ø 42 mm	1
38092	RACCORDO SUPERIORE UPPER CONNECTION	1

Art. KR3351		
KIT GUARNIZIONI COMPLETO		
COMPOSTO DALLE GUARNIZIONI SOTTO ELENCAE		
JOINTS GASKETS LIST		
INCLUDING ALL THE GASKETS SHOWN HERE UNDER		
CODICE CODE	DESCRIZIONE DESCRIPTION	Q.TÀ QTY
H034	O-RING 3156 O-RING 3156	1
H037	O-RING 3137 O-RING 3137	1
H038	O-RING 115 O-RING 115	1
H039	O-RING 3225 O-RING 3225	4
H040	O-RING 123 O-RING 123	1
H050	O-RING 3075 O-RING 3075	1
H058	O-RING 2068 O-RING 2068	1
H091	GUARNIZIONE PACCO PICCOLA GASKET	4
H092	GUARNIZIONE PACCO GRANDE GASKET	3
H094	GUARNIZIONI BASE DISTRIBUTORE GASKET	1
H109	O-RING 3131 O-RING 3131	1
H135	O-RING 115 "VITON" O-RING 115 "VITON"	1
H136	O-RING 119 "VITON" O-RING 119 "VITON"	1
H160	O-RING 2093 O-RING 2093	1
H198	O-RING 3106 O-RING 3106	1
H200	O-RING 3162 O-RING 3162	1
I012	DISTRIBUTORE ARIA SLIDE VALVE	1
KC105	PISTONE PISTON	1
O254	SILENZIATORE A PASTICCA MUFFLER	1
O258	SILENZIATORE A PASTICCA MUFFLER	2

Art. KS3381		
SET RICAMBI CONSIGLIATI		
AI PUNTI VENDITA E ASSISTENZA,		
COMPOSTO DAI RICAMBI SOTTO ELENCAE		
SPARE PARTS KIT ADVISED		
TO THE REPAIR CENTERS. THIS KIT INCLUDES		
ALL THE SPARE PARTS SHOWN HERE UNDER		
CODICE CODE	DESCRIZIONE DESCRIPTION	Q.TÀ QTY
A044	CILINDRO MOTORE MOTOR CYLINDER	1
A829	ALBERO INFERIORE LOWER SPINDLE	1
KR3305	DOPPIO GRUPPO INVERTITORE DOUBLE PLUNGER GROUP	1
KR3306	GRUPPO DISTRIBUTORE D'ARIA SLIDE VALVE GROUP	1
KR3351	KIT GUARNIZIONI COMPLETO COMPLETE GASKETS KIT	1



Art. 33070 Mod. 1:1/60EV - Art. 33070/A Mod. 1:1/60EX - Art. 33071 Mod. 1:1/60EV
 Art. 33072 Mod. 1:1/94EV - Art. 33073 Mod. 1:1/94EV



VISTA ESPLOSA - EXPLODED VIEW

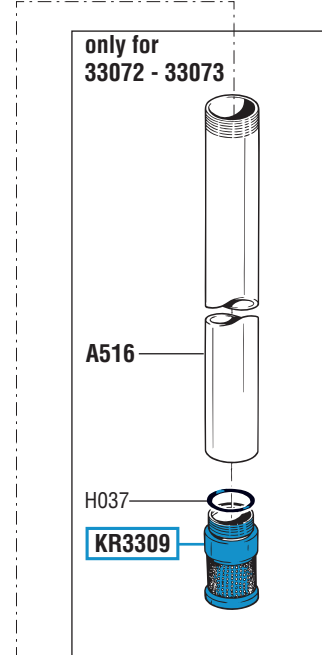
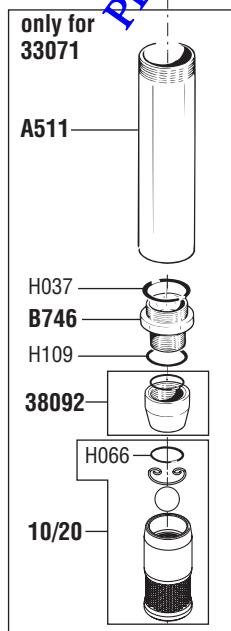
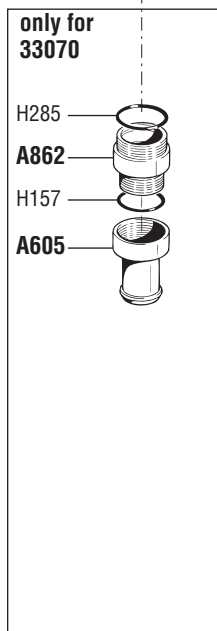
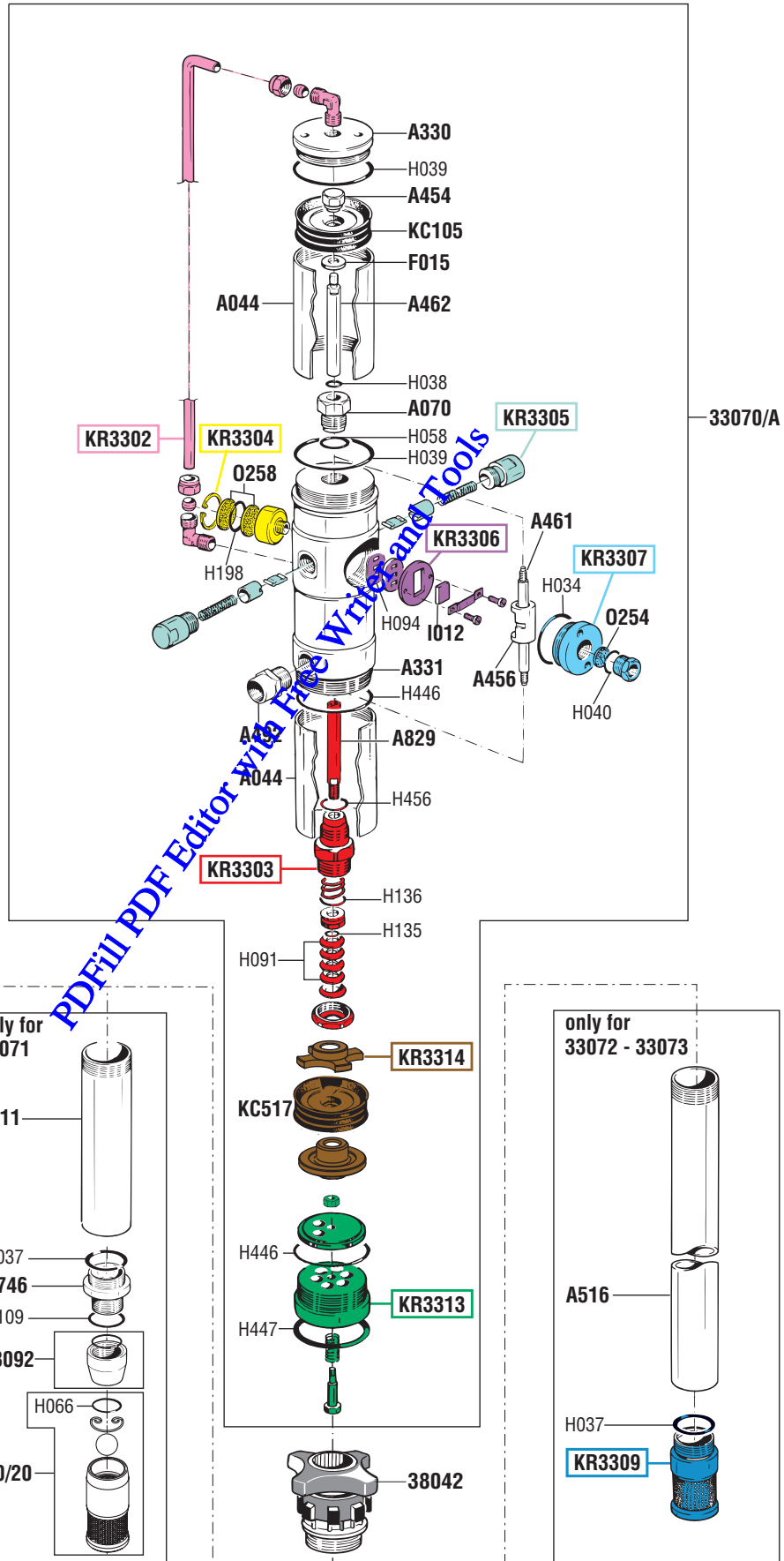
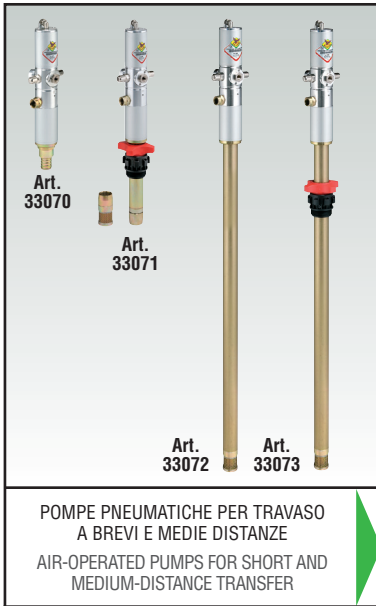

PDFFill PDF Editor with Free Watermark Tools



GUIDA RICAMBI - SPARE PARTS GUIDE

KIT RICAMBI OGNI KIT SOTTO RIPORTATO COMPRENDE I RICAMBI EVIDENZIATI CON LO STESSO COLORE E LE RELATIVE GUARNIZIONI. QUESTI RICAMBI NON SONO FORNIBILI SEPARATAMENTE TRANNE QUELLI CODIFICATI.		
SPARE PARTS KITS EACH KIT SHOWN WITH THE SAME COLOR INCLUDES ALSO THE GASKETS. THE SPARE PARTS INCLUDED IN THE KIT CAN'T BE SUPPLIED SEPARATELY EXCEPT THOSE SHOWN WITH A PROPER CODE.		
CODICE CODE	DESCRIZIONE DESCRIPTION	Q.TÀ QTY
KR3302	TUBO RICICLO CON RACCORDI TUBE WITH CONNECTIONS	1
KR3303	PACCO GUARNIZIONI GASKETS KIT	1
KR3304	SILENZIATORE MUFFLER	1
KR3305	DOPPIO GRUPPO INVERTITORE DOUBLE PLUNGER GROUP	1
KR3306	GRUPPO DISTRIBUTORE D'ARIA SLIDE VALVE GROUP	1
KR3307	TAPPO ENTRATA ARIA AIR INLET CONNECTION	1
KR3309	FILTRO PESCANTE SHANK FILTER	1
KR3313	VALVOLA ASPIRAZIONE SUCTION VALVE	1
KR3314	PISTONE ASPIRAZIONE SUCTION PISTON	1

ELENCO RICAMBI FORNIBILI SINGOLARMENTE LIST OF SPARE PARTS WHICH CAN BE SUPPLIED SEPARATELY		
CODICE CODE	DESCRIZIONE DESCRIPTION	Q.TÀ QTY
A044	CILINDRO MOTORE MOTOR CYLINDER	2
A070	GUIDA STELO ROD GUIDE	1
A330	TESTA MOTORE MOTOR HEAD	1
A331	CORPO MOTORE POMPA PUMP MOTOR BODY	1
A454	DADO BLOCCA PISTONE PISTON LOCKING NUT	1
A456	SPINGI INVERTITORE SHUTTLE	1
A461	ALBERO CENTRALE MOTORE MOTOR SPINDLE	1
A462	ALBERO PISTONE MOTORE MOTOR PISTON SPINDLE	1
A492	ADATTATORE M 1/2" G x F 1/2" G ADAPTOR M 1/2" G x F 1/2" G	1
A511	TUBO PESCANTE Art. 33071 SUCTION TUBE Art. 33071	1
A516	TUBO PESCANTE Art. 33072 - 33073 SUCTION TUBE Art. 33072 - 33073	1
A605	PORTATUBO A RESCA Art. 33070 HOSE HOLDER Art. 33070	1
A829	ALBERO INFERIORE LOWER SPINDLE	1
A862	RACCORDO Art. 33070 UNION Art. 33070	1
B746	PORTA VALVOLA FILETTATO Art. 33071 THREADED TUBE HOLDER Art. 33071	1
F015	RONDELLA WASHER	1
10/20	FILTRO VALVOLA PESCANTE FILETTATO 1" SHANK FILTER F 1"	1
38042	GHERA DI BLOCCAGGIO ø 42 mm BUNG ADAPTOR ø 42 mm	1
38092	RACCORDO SUPERIORE UPPER CONNECTION	1

Art. KR3355	KIT GUARNIZIONI COMPLETO COMPOSTO DALLE GUARNIZIONI SOTTO ELENCAE JOINTS GASKETS LIST INCLUDING ALL THE GASKETS SHOWN HERE UNDER	
CODICE CODE	DESCRIZIONE DESCRIPTION	Q.TÀ QTY
H034	O-RING 3156 O-RING 3156	1
H037	O-RING 3137 O-RING 3137	1
H038	O-RING 115 O-RING 115	1
H039	O-RING 3225 O-RING 3225	2
H040	O-RING 123 O-RING 123	1
H058	O-RING 2068 O-RING 2068	1
H091	GUARNIZIONE PACCO PICCOLA GASKET	4
H094	GUARNIZIONI BASE DISTRIBUTORE GASKET	1
H135	O-RING 115 "VITON" O-RING 115 "VITON"	1
H136	O-RING 119 "VITON" O-RING 119 "VITON"	1
H157	O-RING 3137 "VITON" O-RING 3137 "VITON"	1
H198	O-RING 3106 O-RING 3106	1
H285	O-RING 3131 "VITON" O-RING 3131 "VITON"	1
H446	O-RING 3225 "VITON" O-RING 3225 "VITON"	2
H447	O-RING 3162 "VITON" O-RING 3162 "VITON"	1
H456	O-RING 3075 "VITON" O-RING 3075 "VITON"	1
I012	DISTRIBUTORE ARIA SLIDE VALVE	1
KC105	PISTONE PISTON	1
KC517	PISTONE "VITON" PISTON "VITON"	1
O254	SILENZIATORE A PASTICCA MUFFLER	1
O258	SILENZIATORE A PASTICCA MUFFLER	2

Art. KS3383	SET RICAMBI CONSIGLIATI AI PUNTI VENDITA E ASSISTENZA, COMPOSTO DAI RICAMBI SOTTO ELENCAE SPARE PARTS KIT ADVISED TO THE REPAIR CENTERS. THIS KIT INCLUDES ALL THE SPARE PARTS SHOWN HERE UNDER	
CODICE CODE	DESCRIZIONE DESCRIPTION	Q.TÀ QTY
A044	CILINDRO MOTORE MOTOR CYLINDER	1
A829	ALBERO INFERIORE LOWER SPINDLE	1
KR3305	DOPPIO GRUPPO INVERTITORE DOUBLE PLUNGER GROUP	1
KR3306	GRUPPO DISTRIBUTORE D'ARIA SLIDE VALVE GROUP	1
KR3355	KIT GUARNIZIONI COMPLETO COMPLETE GASKETS KIT	1

RAASM

FLUIDS AND LUBRICATION EQUIPMENT



Art. 33080 Mod. 1:1/60E NBR - Art. 33081 Mod. 1:1/60E NBR
 Art. 33082 Mod. 1:1/94E NBR - Art. 33083 Mod. 1:1/94E NBR



VISTA ESPLOSA - EXPLODED VIEW

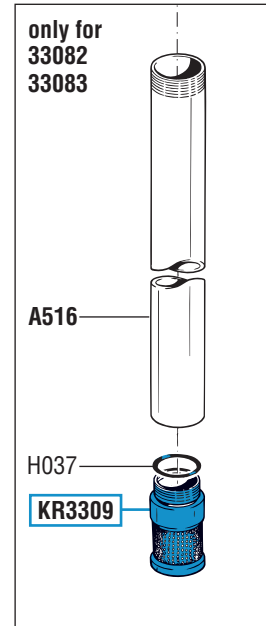
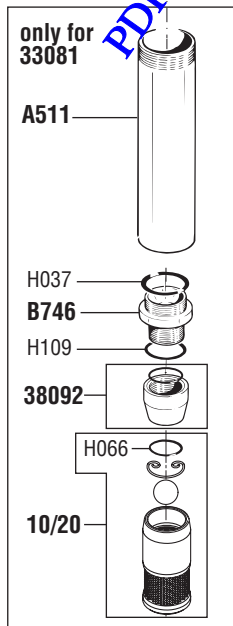
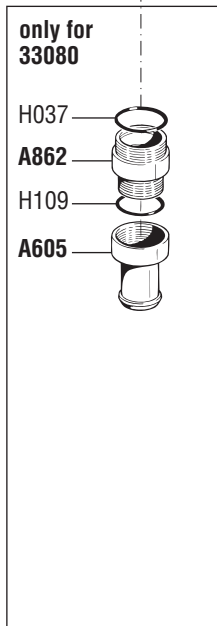
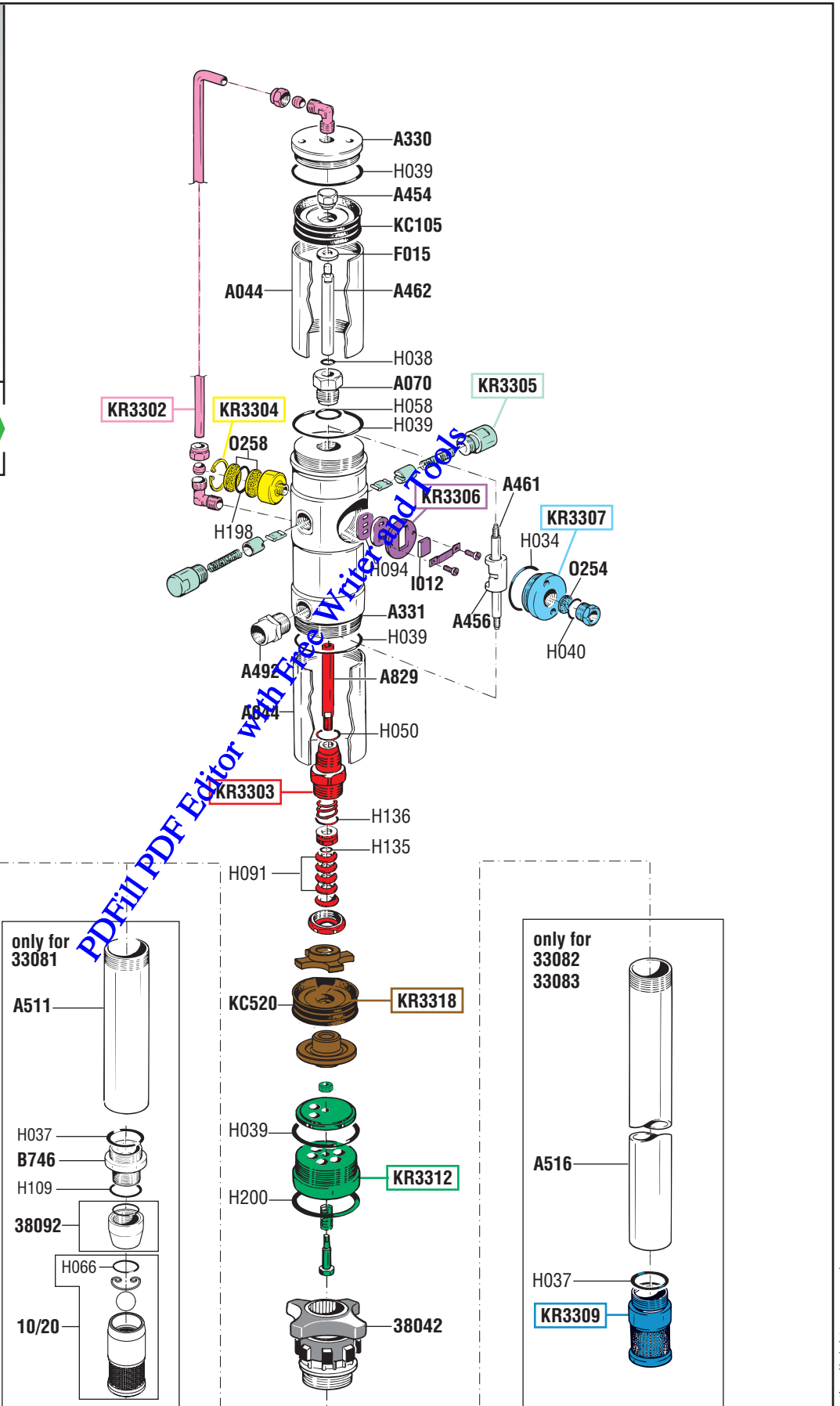
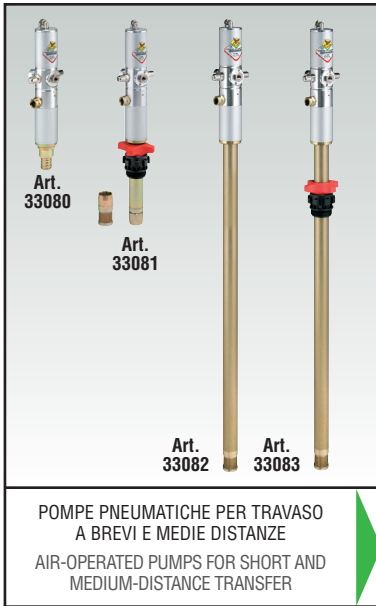

PDFFill PDF Editor with Free Writer Add Tools



GUIDA RICAMBI - SPARE PARTS GUIDE

KIT RICAMBI OGNI KIT SOTTO RIPORTATO COMPRENDE I RICAMBI EVIDENZIATI CON LO STESSO COLORE E LE RELATIVE GUARNIZIONI. QUESTI RICAMBI NON SONO FORNIBILI SEPARATAMENTE TRANNE QUELLI CODIFICATI.		
SPARE PARTS KITS EACH KIT SHOWN WITH THE SAME COLOR INCLUDES ALSO THE GASKETS. THE SPARE PARTS INCLUDED IN THE KIT CAN'T BE SUPPLIED SEPARATELY EXCEPT THOSE SHOWN WITH A PROPER CODE.		
CODICE CODE	DESCRIZIONE DESCRIPTION	Q.TÀ QTY
KR3302	TUBO RICICLO CON RACCORDI TUBE WITH CONNECTIONS	1
KR3303	PACCO GUARNIZIONI GASKETS KIT	1
KR3304	SILENZIATORE MUFFLER	1
KR3305	DOPPIO GRUPPO INVERTITORE DOUBLE PLUNGER GROUP	1
KR3306	GRUPPO DISTRIBUTORE D'ARIA SLIDE VALVE GROUP	1
KR3307	TAPPO ENTRATA ARIA AIR INLET CONNECTION	1
KR3309	FILTRO PESCANTE SHANK FILTER	1
KR3312	VALVOLA ASPIRAZIONE SUCTION VALVE	1
KR3318	PISTONE ASPIRAZIONE SUCTION PISTON	1

ELENCO RICAMBI FORNIBILI SINGOLARMENTE LIST OF SPARE PARTS WHICH CAN BE SUPPLIED SEPARATELY		
CODICE CODE	DESCRIZIONE DESCRIPTION	Q.TÀ QTY
A044	CILINDRO MOTORE MOTOR CYLINDER	2
A070	GUIDA STELO ROD GUIDE	1
A330	TESTA MOTORE MOTOR HEAD	1
A331	CORPO MOTORE POMPA PUMP MOTOR BODY	1
A454	DADO BLOCCA PISTONE PISTON LOCKING NUT	1
A456	SPINGI INVERTITORE SHUTTLE	1
A461	ALBERO CENTRALE MOTORE MOTOR SPINDLE	1
A462	ALBERO PISTONE MOTORE MOTOR PISTON SPINDLE	1
A492	ADATTATORE M 1/2" G x F 1/2" G ADAPTOR M 1/2" G x F 1/2" G	1
A511	TUBO PESCANTE Art. 33081 SUCTION TUBE Art. 33081	1
A516	TUBO PESCANTE Art. 33082 - 33083 SUCTION TUBE Art. 33082 - 33083	1
A605	PORTATUBO A RESCA Art. 33080 HOSE HOLDER Art. 33080	1
A829	ALBERO INFERIORE LOWER SPINDLE	1
A862	RACCORDO Art. 33080 UNION Art. 33080	1
B746	PORTA VALVOLA FILETTATO Art. 33081 THREADED TUBE HOLDER Art. 33081	1
F015	RONDELLA WASHER	1
KC520	PISTONE "NBR" PISTON "NBR"	1
10/20	FILTRO VALVOLA PESCANTE FILETTO F 1" SHANK FILTER F 1"	1
38042	GHIERA DI BLOCCAGGIO 42 mm BUNG ADAPTOR ø 42 mm	1
38092	RACCORDO SUPERIORE F 1" UPPER CONNECTION F 1"	1

Art. KR3354 KIT GUARNIZIONI COMPLETO COMPOSTO DALLE GUARNIZIONI SOTTO ELENCAE JOINTS GASKETS LIST INCLUDING ALL THE GASKETS SHOWN HERE UNDER		
CODICE CODE	DESCRIZIONE DESCRIPTION	Q.TÀ QTY
H034	O-RING 3156 O-RING 3156	1
H037	O-RING 3137 O-RING 3137	1
H038	O-RING 115 O-RING 115	1
H039	O-RING 3225 O-RING 3225	4
H040	O-RING 123 O-RING 123	1
H050	O-RING 3075 O-RING 3075	1
H058	O-RING 2068 O-RING 2068	1
H091	GUARNIZIONE PACCO PICCOLA GASKET	4
H094	GUARNIZIONI BASE DISTRIBUTORE GASKET	1
H109	O-RING 3131 O-RING 3131	1
H135	O-RING 115 "VITON" O-RING 115 "VITON"	1
H136	O-RING 119 "VITON" O-RING 119 "VITON"	1
H198	O-RING 3106 O-RING 3106	1
H200	O-RING 3162 O-RING 3162	1
I012	DISTRIBUTORE ARIA SLIDE VALVE	1
KC105	PISTONE PISTON	1
O254	SILENZIATORE A PASTICCA MUFFLER	1
O258	SILENZIATORE A PASTICCA MUFFLER	2

Art. KS3384 SET RICAMBI CONSIGLIATI AI PUNTI VENDITA E ASSISTENZA, COMPOSTO DAI RICAMBI SOTTO ELENCAE SPARE PARTS KIT ADVISED TO THE REPAIR CENTERS. THIS KIT INCLUDES ALL THE SPARE PARTS SHOWN HERE UNDER		
CODICE CODE	DESCRIZIONE DESCRIPTION	Q.TÀ QTY
A044	CILINDRO MOTORE MOTOR CYLINDER	1
A829	ALBERO INFERIORE LOWER SPINDLE	1
KR3305	DOPPIO GRUPPO INVERTITORE DOUBLE PLUNGER GROUP	1
KR3306	GRUPPO DISTRIBUTORE D'ARIA SLIDE VALVE GROUP	1
KR3354	KIT GUARNIZIONI COMPLETO COMPLETE GASKETS KIT	1



Art. 33124

VISTA ESPLOSA - EXPLODED VIEW



KIT MURALE
PER SVUOTAMENTO
WALL-MOUNTED
DRAINING KIT

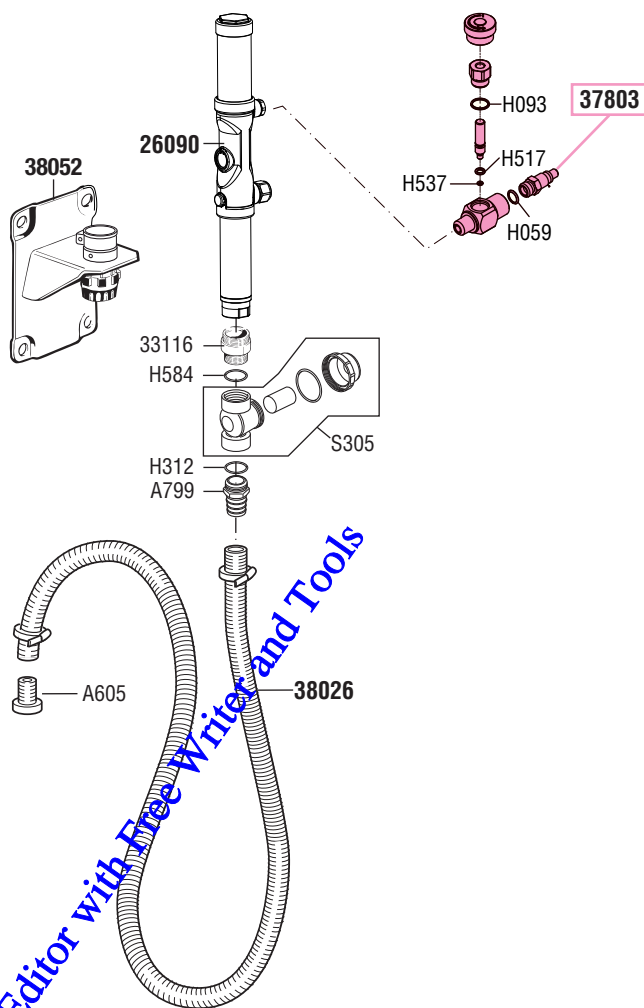

GUIDA RICAMBI - SPARE PARTS GUIDE

KIT RICAMBI
OGNI KIT SOTTO RIPORTATO COMPRENDE I RICAMBI EVIDENZIATI CON LO STESSO COLORE E LE RELATIVE GUARNIZIONI. QUESTI RICAMBI NON SONO FORNIBILI SEPARATAMENTE TRANNE QUELLI CODIFICATI.

SPARE PARTS KITS
EACH KIT SHOWN WITH THE SAME COLOR INCLUDES ALSO THE GASKETS. THE SPARE PARTS INCLUDED IN THE KIT CAN'T BE SUPPLIED SEPARATELY EXCEPT THOSE SHOWN WITH A PROPER CODE.

CODICE CODE	DESCRIZIONE DESCRIPTION	Q.TÀ QTY
37803	REGOLATORE DI FLUSSO ARIA AIR FLOW REGULATING VALVE	1

ELENCO RICAMBI FORNIBILI SINGOLARMENTE
LIST OF SPARE PARTS WHICH CAN BE SUPPLIED SEPARATELY

CODICE CODE	DESCRIZIONE DESCRIPTION	Q.TÀ QTY
26090	POMPA DA TRAVASO R 1:1 TRANSFER PUMP R 1:1	1
33116	NIPPLE M 1" G x M 1" G NIPPLE M 1" G x M 1" G	1
38052	STAFFA MURALE ø 50 mm WALL BRACKET ø 50 mm	1
38026	TUBO PESCANTE FLESSIBILE FLEXIBLE SUCTION TUBE	1
A605	PORTATUBO A RESCA TUBE CONNECTION	1
A799	PORTATUBO A RESCA HOSE HOLDER	1
S305	FILTRO DI LINEA FF 1" LINE FILTER FF 1"	1
H059	O-RING 2037 O-RING 2037	1
H093	O-RING 2050 "VITON" O-RING 2050 "VITON"	1
H312	O-RING 3118 "VITON" O-RING 3118 "VITON"	1
H517	O-RING 2018 "VITON" O-RING 2018 "VITON"	1
H537	O-RING "NBR" O-RING "NBR"	1
H584	ANELLO DI POSIZIONAMENTO LOCATING RING	1

SET RICAMBI CONSIGLIATI
AI PUNTI VENDITA E ASSISTENZA,
COMPOSTO DAI RICAMBI SOTTO ELENCATI

Art. KS3387

SPARE PARTS KIT ADVISED
TO THE REPAIR CENTERS. THIS KIT INCLUDES ALL THE SPARE PARTS SHOWN HERE UNDER

CODICE CODE	DESCRIZIONE DESCRIPTION	Q.TÀ QTY
KR2603	GRUPPO PISTONE MOTORE POMPANTE PUMPING MOTOR PISTON GROUP	1
KR3358	KIT GUARNIZIONI COMPLETO COMPLETE GASKETS KIT	1
N131	MOLLA SPRING	1
N139	MOLLA CONICA CONIC SPRING	1

PER I KIT RICAMBI DELL' Art. 26090 VEDERE I RELATIVI ESPLOSI
FOR THE SPARE PARTS KITS OF Art. 26090 PLEASE REFER TO PERTINENT EXPLODED VIEWS



Art. 33125

VISTA ESPLOSA - EXPLODED VIEW



KIT MURALE
PER SVUOTAMENTO
WALL-MOUNTED
DRAINING KIT

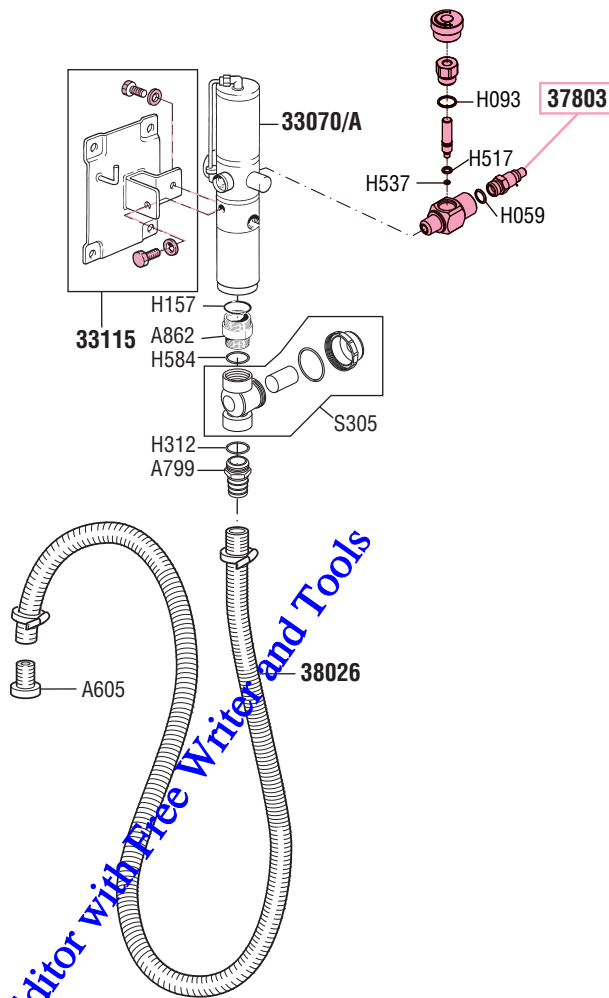

GUIDA RICAMBI - SPARE PARTS GUIDE

KIT RICAMBI
OGNI KIT SOTTO RIPORTATO COMPRENDE I RICAMBI EVIDENZIATI CON LO STESSO COLORE E LE RELATIVE GUARNIZIONI. QUESTI RICAMBI NON SONO FORNIBILI SEPARATAMENTE TRANNE QUELLI CODIFICATI.

SPARE PARTS KITS
EACH KIT SHOWN WITH THE SAME COLOR INCLUDES ALSO THE GASKETS. THE SPARE PARTS INCLUDED IN THE KIT CAN'T BE SUPPLIED SEPARATELY EXCEPT THOSE SHOWN WITH A PROPER CODE.

CODICE CODE	DESCRIZIONE DESCRIPTION	Q.TÀ QTY
37803	REGOLATORE DI FLUSSO ARIA AIR FLOW REGULATING VALVE	1

ELENCO RICAMBI FORNIBILI SINGOLARMENTE
LIST OF SPARE PARTS WHICH CAN BE SUPPLIED SEPARATELY

CODICE CODE	DESCRIZIONE DESCRIPTION	Q.TÀ QTY
33070/A	POMPA DA TRAVASO R 1:1 TRANSFER PUMP R 1:1	1
33115	STAFFA MURALE WALL BRACKET	1
38026	TUBO PESCANTE FLESSIBILE FLEXIBLE SUCTION TUBE	1
A605	PORTATUBO A RESCA TUBE CONNECTION	1
A799	PORTATUBO A RESCA HOSE HOLDER	1
A862	RACCORDO CONNECTION	1
S305	FILTRO DI LINEA FF 1" LINE FILTER FF 1"	1
H059	O-RING 2037 O-RING 2037	1
H093	O-RING 2050 "VITON" O-RING 2050 "VITON"	1
H157	O-RING 3137 "VITON" O-RING 3137 "VITON"	1
H312	O-RING 3118 "VITON" O-RING 3118 "VITON"	1
H517	O-RING 2018 "VITON" O-RING 2018 "VITON"	1
H537	O-RING "NBR" O-RING "NBR"	1
H584	ANELLO DI POSIZIONAMENTO LOCATING RING	1

SET RICAMBI CONSIGLIATI
AI PUNTI VENDITA E ASSISTENZA,
COMPOSTO DAI RICAMBI SOTTO ELENCATI

Art. KS3383

SPARE PARTS KIT ADVISED
TO THE REPAIR CENTERS. THIS KIT INCLUDES ALL THE SPARE PARTS SHOWN HERE UNDER

CODICE CODE	DESCRIZIONE DESCRIPTION	Q.TÀ QTY
A044	CILINDRO MOTORE MOTOR CYLINDER	1
A829	ALBERO INFERIORE LOWER SPINDLE	1
KR3305	DOPPIO GRUPPO INVERTITORE DOUBLE PLUNGER GROUP	1
KR3306	GRUPPO DISTRIBUTORE D'ARIA SLIDE VALVE GROUP	1
KR3355	KIT GUARNIZIONI COMPLETO COMPLETE GASKETS KIT	1

PER I KIT RICAMBI DELL' Art. 33070/A VEDERE I RELATIVI ESPLOSI
FOR THE SPARE PARTS KITS OF Art. 33070/A PLEASE REFER TO PERTINENT EXPLODED VIEWS

tutti i diritti riservati - all rights reserved



Art. 33135

VISTA ESPLOSA - EXPLODED VIEW



KIT MURALE
PER SVUOTAMENTO
WALL-MOUNTED
DRAINING KIT

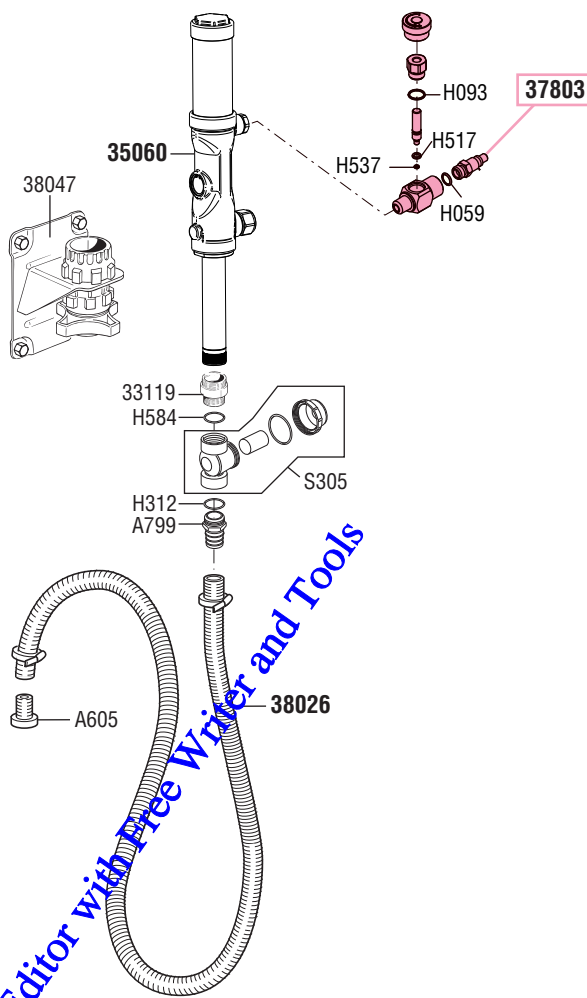

GUIDA RICAMBI - SPARE PARTS GUIDE

KIT RICAMBI
OGNI KIT SOTTO RIPORTATO COMPRENDE I RICAMBI EVIDENZIATI CON LO STESSO COLORE E LE RELATIVE GUARNIZIONI. QUESTI RICAMBI NON SONO FORNIBILI SEPARATAMENTE TRANNE QUELLI CODIFICATI.

SPARE PARTS KITS
EACH KIT SHOWN WITH THE SAME COLOR INCLUDES ALSO THE GASKETS. THE SPARE PARTS INCLUDED IN THE KIT CAN'T BE SUPPLIED SEPARATELY EXCEPT THOSE SHOWN WITH A PROPER CODE.

CODICE CODE	DESCRIZIONE DESCRIPTION	Q.TÀ QTY
37803	REGOLATORE DI FLUSSO ARIA AIR FLOW REGULATING VALVE	1

ELENCO RICAMBI FORNIBILI SINGOLARMENTE
LIST OF SPARE PARTS WHICH CAN BE SUPPLIED SEPARATELY

CODICE CODE	DESCRIZIONE DESCRIPTION	Q.TÀ QTY
35060	POMPA DA TRAVASO R 3:1 TRANSFER PUMP R 3:1	1
38047	STAFFA MURALE WALL BRACKET	1
38026	TUBO PESCANTE FLESSIBILE FLEXIBLE SUCTION TUBE	1
A605	PORTATUBO A RESCA TUBE CONNECTION	1
A799	PORTATUBO A RESCA HOSE HOLDER	1
33119	NIPPLE M 1" G x M 3/4" G NIPPLE M 1" G x M 3/4" G	1
S305	FILTRO DI LINEA FF 1" LINE FILTER FF 1"	1
H059	O-RING 2037 O-RING 2037	1
H093	O-RING 2050 "VITON" O-RING 2050 "VITON"	1
H312	O-RING 3118 "VITON" O-RING 3118 "VITON"	1
H517	O-RING 2018 "VITON" O-RING 2018 "VITON"	1
H537	O-RING "NBR" O-RING "NBR"	1
H584	ANELLO DI POSIZIONAMENTO LOCATING RING	1

Art. KS3386

SET RICAMBI CONSIGLIATI
AI PUNTI VENDITA E ASSISTENZA,
COMPOSTO DAI RICAMBI SOTTO ELENCATI

SPARE PARTS KIT ADVISED
TO THE REPAIR CENTERS. THIS KIT INCLUDES
ALL THE SPARE PARTS SHOWN HERE UNDER

CODICE CODE	DESCRIZIONE DESCRIPTION	Q.TÀ QTY
KR2603	GRUPPO PISTONE MOTORE POMPANTE PUMPING MOTOR PISTON GROUP	1
KR3357	KIT GUARNIZIONI COMPLETO COMPLETE GASKETS KIT	1
N131	MOLLA SPRING	1
N139	MOLLA CONICA CONIC SPRING	1

PER I KIT RICAMBI DELL' Art. 35060 VEDERE I RELATIVI ESPLOSI
FOR THE SPARE PARTS KITS OF Art. 35060 PLEASE REFER TO PERTINENT EXPLODED VIEWS

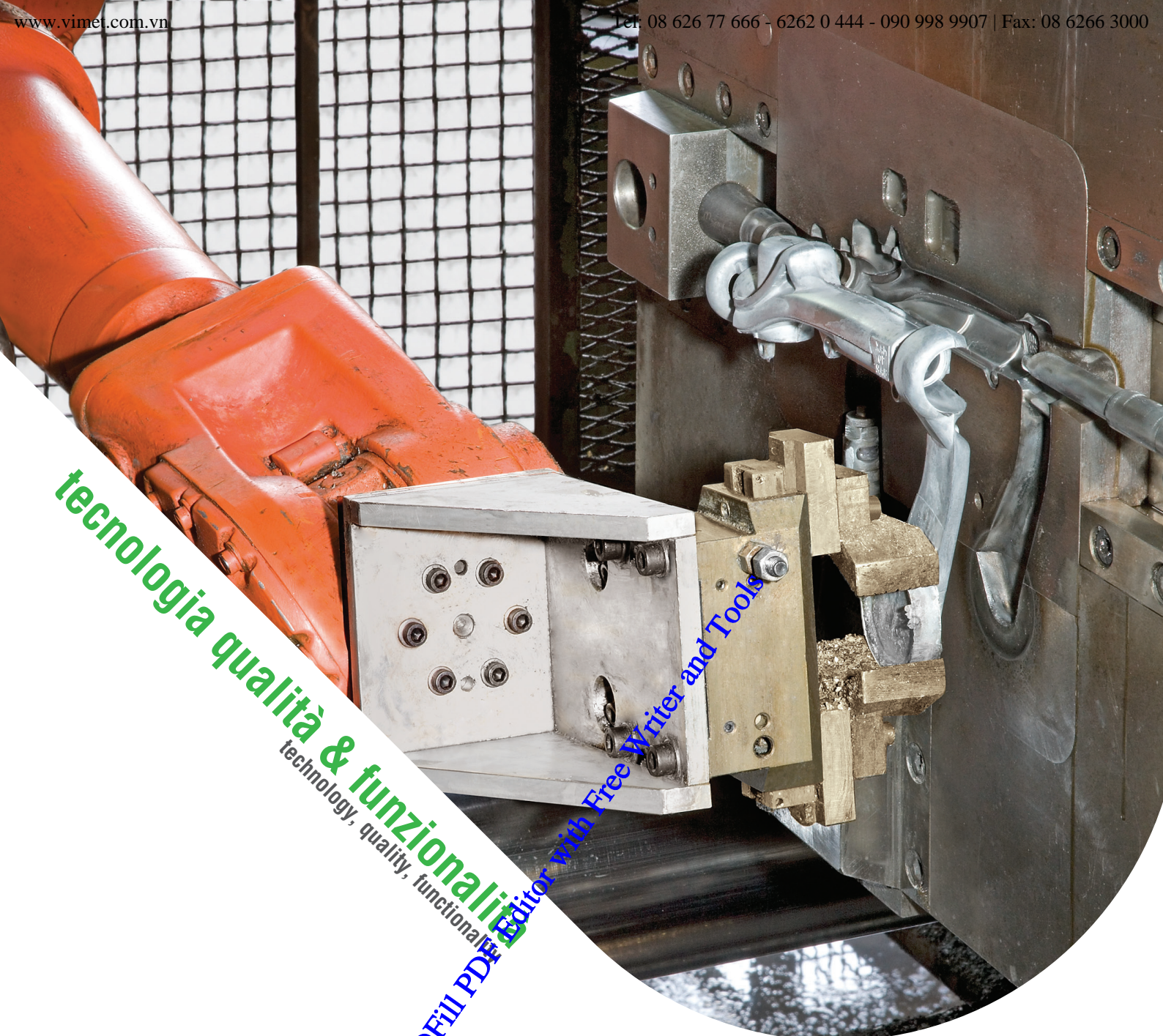

tecnologia qualità & funzionalità
technology, quality, functionality

PDFill PDF Editor with Free Writer and Tools

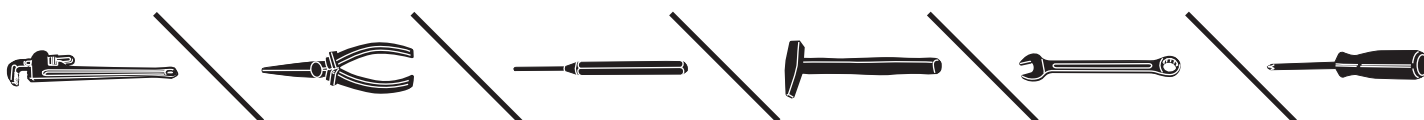



Art. 33146 - Art. 33147 - Art. 33148

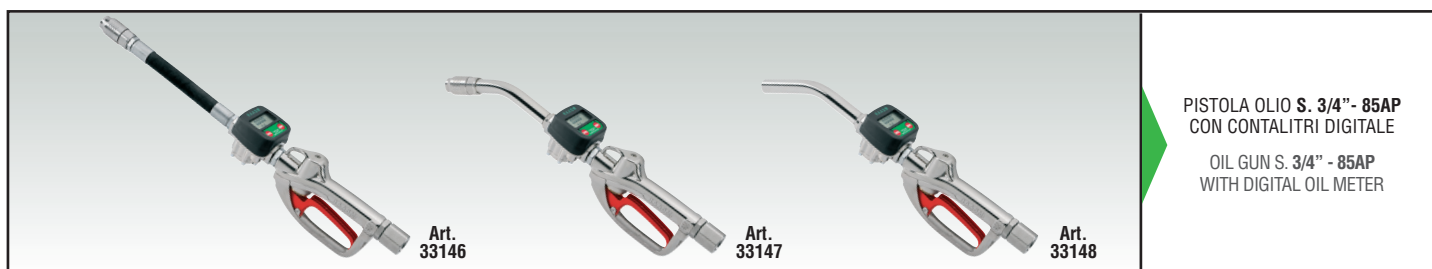
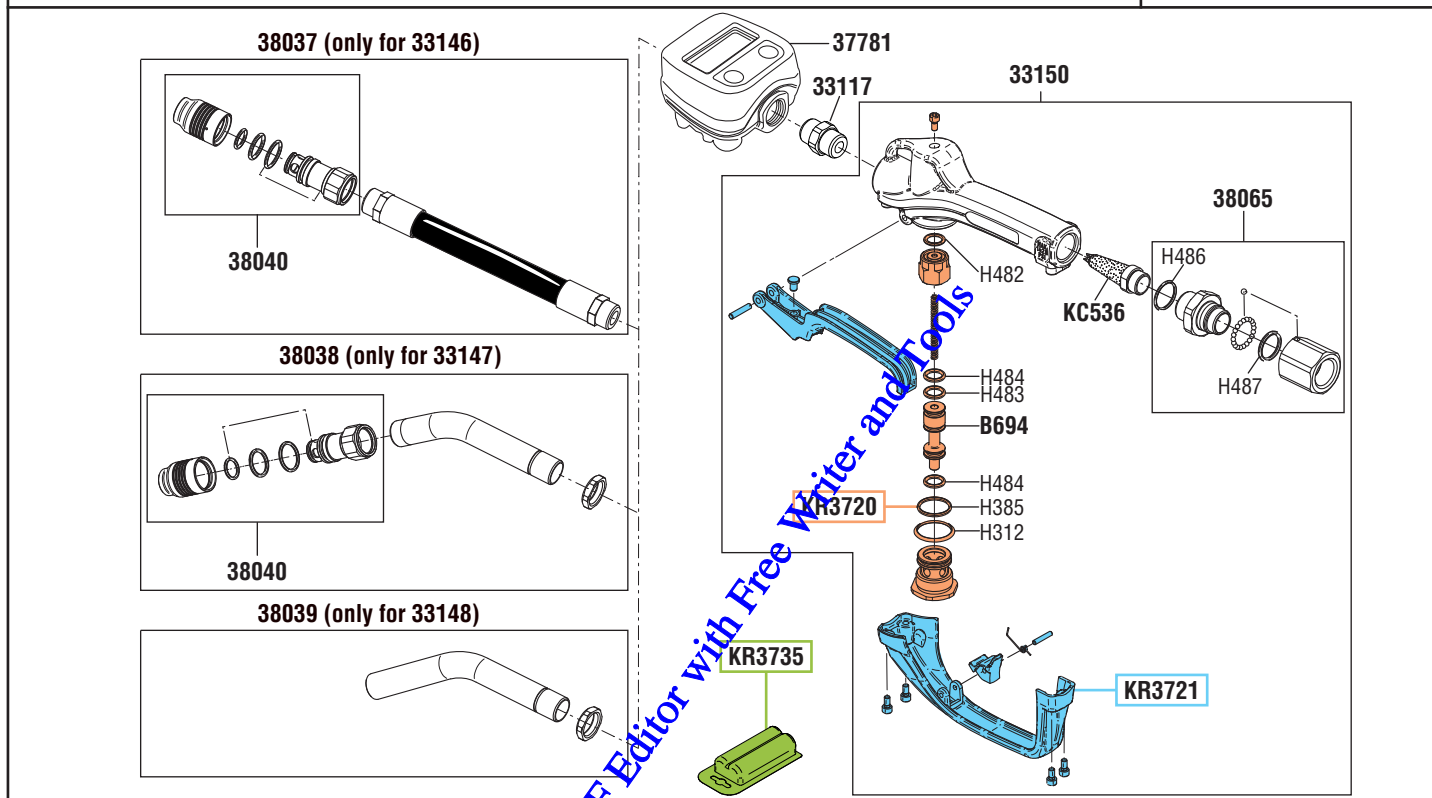

VISTA ESPLOSA - EXPLODED VIEW

PISTOLA OLIO S. 3/4" - 85AP
CON CONTALITRI DIGITALEOIL GUN S. 3/4" - 85AP
WITH DIGITAL OIL METER

tutti i diritti riservati - all rights reserved

GUIDA RICAMBI - SPARE PARTS GUIDE

KIT RICAMBI

OGNI KIT SOTTO RIPORTATO COMPRENDE I RICAMBI EVIDENZIATI CON LO STESSO COLORE E LE RELATIVE GUARNIZIONI. QUESTI RICAMBI NON SONO FORNIBILI SEPARATAMENTE TRANNE QUELLI CODIFICATI.

SPARE PARTS KITS

EACH KIT SHOWN WITH THE SAME COLOR INCLUDES ALSO THE GASKETS. THE SPARE PARTS INCLUDED IN THE KIT CAN'T BE SUPPLIED SEPARATELY EXCEPT THOSE SHOWN WITH A PROPER CODE.

CODICE CODE	DESCRIZIONE DESCRIPTION	Q.TÀ QTY
KR3720	VALVOLA PISTOLA OLIO OIL GUN VALVE	1
KR3721	LEVA E PULSANTE PISTOLA OLIO OIL GUN LEVER AND LOCKING BUTTON	1
KR3735	KIT 2 BATTERIE MINISTILO "AAA" 1.5V "AAA" 1.5V PENLIGHT BATTERY KITS	1

ELENCO RICAMBI FORNIBILI SINGOLARMENTE

LIST OF SPARE PARTS WHICH CAN BE SUPPLIED SEPARATELY

CODICE CODE	DESCRIZIONE DESCRIPTION	Q.TÀ QTY
33117	NIPPLE M 3/4"G - M 3/4"G NIPPLE M 3/4"G - M 3/4"G	1
33150	IMPUGNATURA IN LEGA DI ALLUMINIO GRIP IN ALUMINIUM ALLOY	1
37781	CONTALITRI DIGITALE "RAASM" DIGITAL OIL METER "RAASM"	1
38037	TERMINALE FLESSIBILE (Art. 33146) FLEXIBLE TERMINAL (Art. 33146)	1
38038	TERMINALE RIGIDO (Art. 33147) RIGID TERMINAL (Art. 33147)	1
38039	TERMINALE ALTA PORTATA (Art. 33148) HIGH DELIVERY RIGID TERMINAL (Art. 33148)	1
38040	UGELLO SALVAGOCCE SEMIAUTOMATICO SEMI-AUTOMATIC DRIP-CATCHER NOZZLE	1
38065	SNODO GIREVOLE SWIVEL JOINT	1
B814	DADO NUT	1
KC536	FILTRO PISTOLA 3/4" GUN FILTER 3/4"	1

Art.
KR3755

KIT GUARNIZIONI COMPLETO

COMPOSTO DALLE GUARNIZIONI SOTTO ELENCAE
JOINTS GASKETS LIST
INCLUDING ALL THE GASKETS SHOWN HERE UNDER

CODICE CODE	DESCRIZIONE DESCRIPTION	Q.TÀ QTY
B694	SPILLO VALVOLA PISTOLA S. 3/4" VALVE GUN PIN S. 3/4"	1
H312	O-RING 3118 "VITON"	1
H385	O-RING 3100 "VITON"	1
H482	O-RING 3050 "VITON" O-RING 3050 "VITON"	1
H483	O-RING "VITON" O-RING "VITON"	1
H484	O-RING "VITON" O-RING "VITON"	2
H486	O-RING 3093 "VITON" O-RING 3093 "VITON"	1
H487	O-RING "VITON" O-RING "VITON"	1
KC536	FILTRO PISTOLA 3/4" GUN FILTER 3/4"	1

Art.
KS3785

SET RICAMBI CONSIGLIATI

AI PUNTI VENDITA E ASSISTENZA,
COMPOSTO DAI RICAMBI SOTTO ELENCAE

SPARE PARTS KIT ADVISED

TO THE REPAIR CENTERS. THIS KIT INCLUDES
ALL THE SPARE PARTS SHOWN HERE UNDER

CODICE CODE	DESCRIZIONE DESCRIPTION	Q.TÀ QTY
KR3720	VALVOLA PISTOLA OLIO OIL GUN VALVE	1
KR3755	KIT GUARNIZIONI COMPLETO COMPLETE GASKETS KIT	1



Art. 33150 - Art. 33151 - Art. 33152 - Art. 33153



VISTA ESPLOSA - EXPLODED VIEW

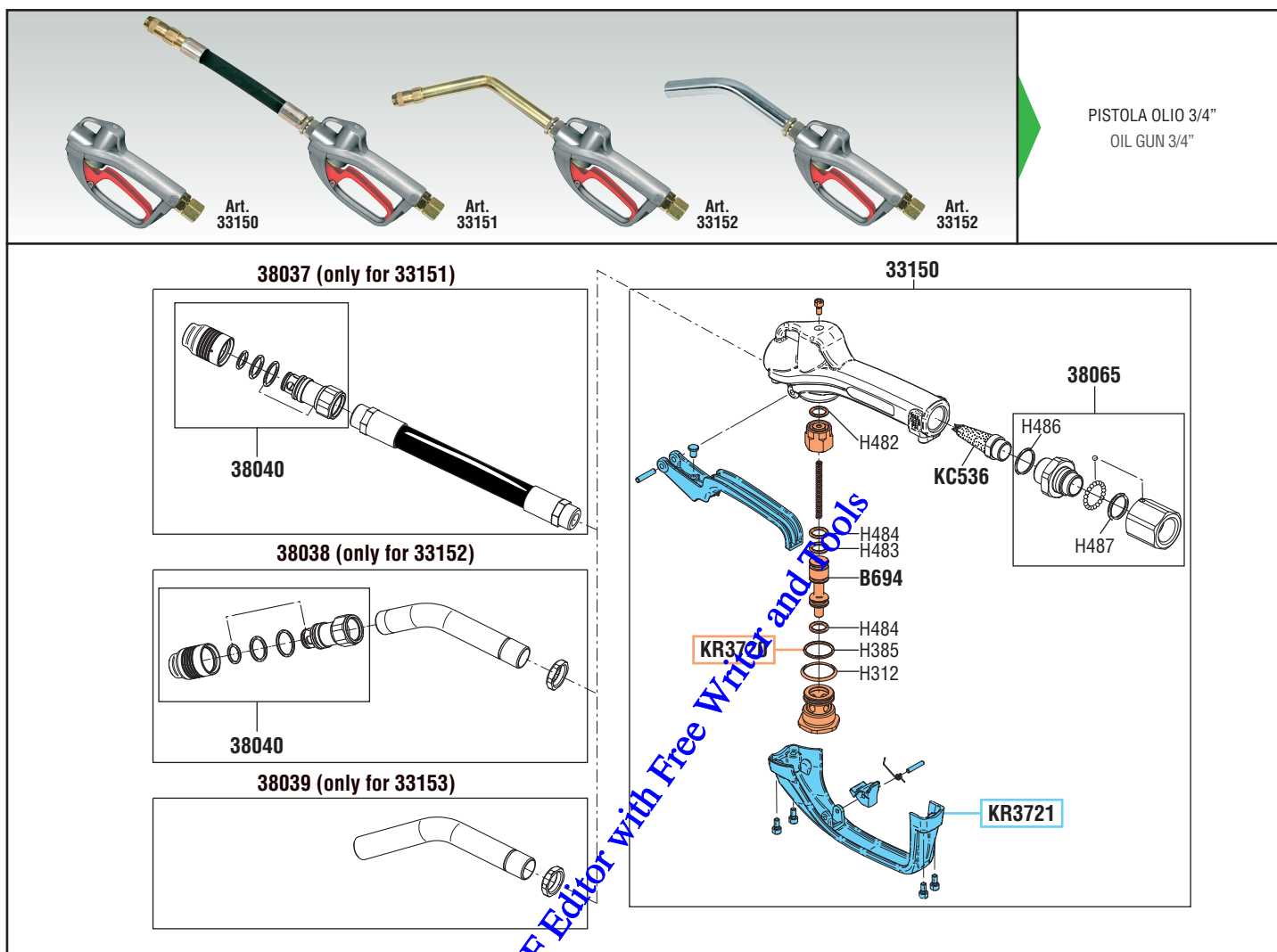

tutti i diritti riservati - all rights reserved

GUIDA RICAMBI - SPARE PARTS GUIDE

KIT RICAMBI

OGNI KIT SOTTO RIPORTATO COMPRENDE I RICAMBI EVIDENZIATI CON LO STESSO COLORE E LE RELATIVE GUARNIZIONI. QUESTI RICAMBI NON SONO FORNIBILI SEPARATAMENTE TRANNE QUELLI CODIFICATI.

SPARE PARTS KITS

EACH KIT SHOWN WITH THE SAME COLOR INCLUDES ALSO THE GASKETS. THE SPARE PARTS INCLUDED IN THE KIT CAN'T BE SUPPLIED SEPARATELY EXCEPT THOSE SHOWN WITH A PROPER CODE.

CODICE CODE	DESCRIZIONE DESCRIPTION	Q.TÀ QTY
KR3720	VALVOLA PISTOLA OLIO OIL GUN VALVE	1
KR3721	LEVA E PULSANTE PISTOLA OLIO OIL GUN LEVER AND LOCKING BUTTON	1

ELENCO RICAMBI FORNIBILI SINGOLARMENTE

LIST OF SPARE PARTS WHICH CAN BE SUPPLIED SEPARATELY

CODICE CODE	DESCRIZIONE DESCRIPTION	Q.TÀ QTY
33150	IMPUGNATURA IN LEGA DI ALLUMINIO GRIP IN ALUMINIUM ALLOY	1
38037	TERMINALE FLESSIBILE (Art. 33151) FLEXIBLE TERMINAL (Art. 33151)	1
38038	TERMINALE RIGIDO (Art. 33152) RIGID TERMINAL (Art. 33152)	1
38039	TERMINALE ALTA PORTATA (Art. 33153) HIGH DELIVERY RIGID TERMINAL (Art. 33153)	1
38040	UGELLO SALVAGOCCE SEMIAUTOMATICO SEMI-AUTOMATIC DRIP-CATCHER NOZZLE	1
38065	SNODO GIREVOLE SWIVEL JOINT	1
KC536	FILTRO PISTOLA 3/4" GUN FILTER 3/4"	1

Art.
KR3755

KIT GUARNIZIONI COMPLETO

COMPOSTO DALLE GUARNIZIONI SOTTO ELENCAE
JOINTS GASKETS LIST
INCLUDING ALL THE GASKETS SHOWN HERE UNDER

CODICE CODE	DESCRIZIONE DESCRIPTION	Q.TÀ QTY
B694	SPILLO VALVOLA PISTOLA S. 3/4" VALVE GUN PIN S. 3/4"	1
H312	O-RING 3118 "VITON"	1
H385	O-RING 3100 "VITON"	1
H482	O-RING 3050 "VITON"	1
H483	O-RING "VITON"	1
H484	O-RING "VITON"	2
H486	O-RING 3093 "VITON"	1
H487	O-RING "VITON"	1
KC536	FILTRO PISTOLA 3/4" GUN FILTER 3/4"	1

Art.
KS3785

SET RICAMBI CONSIGLIATI

AI PUNTI VENDITA E ASSISTENZA,
COMPOSTO DAI RICAMBI SOTTO ELENCAE

SPARE PARTS KIT ADVISED

TO THE REPAIR CENTERS. THIS KIT INCLUDES
ALL THE SPARE PARTS SHOWN HERE UNDER

CODICE CODE	DESCRIZIONE DESCRIPTION	Q.TÀ QTY
KR3720	VALVOLA PISTOLA OLIO OIL GUN VALVE	1
KR3755	KIT GUARNIZIONI COMPLETO COMPLETE GASKETS KIT	1



Art. 33160 Mod. 1:1/60T - Art. 33161 Mod. 1:1/60T
Art. 33194 Mod. 1:1/94T - Art. 33196 Mod. 1:1/94T



VISTA ESPLOSA - EXPLODED VIEW

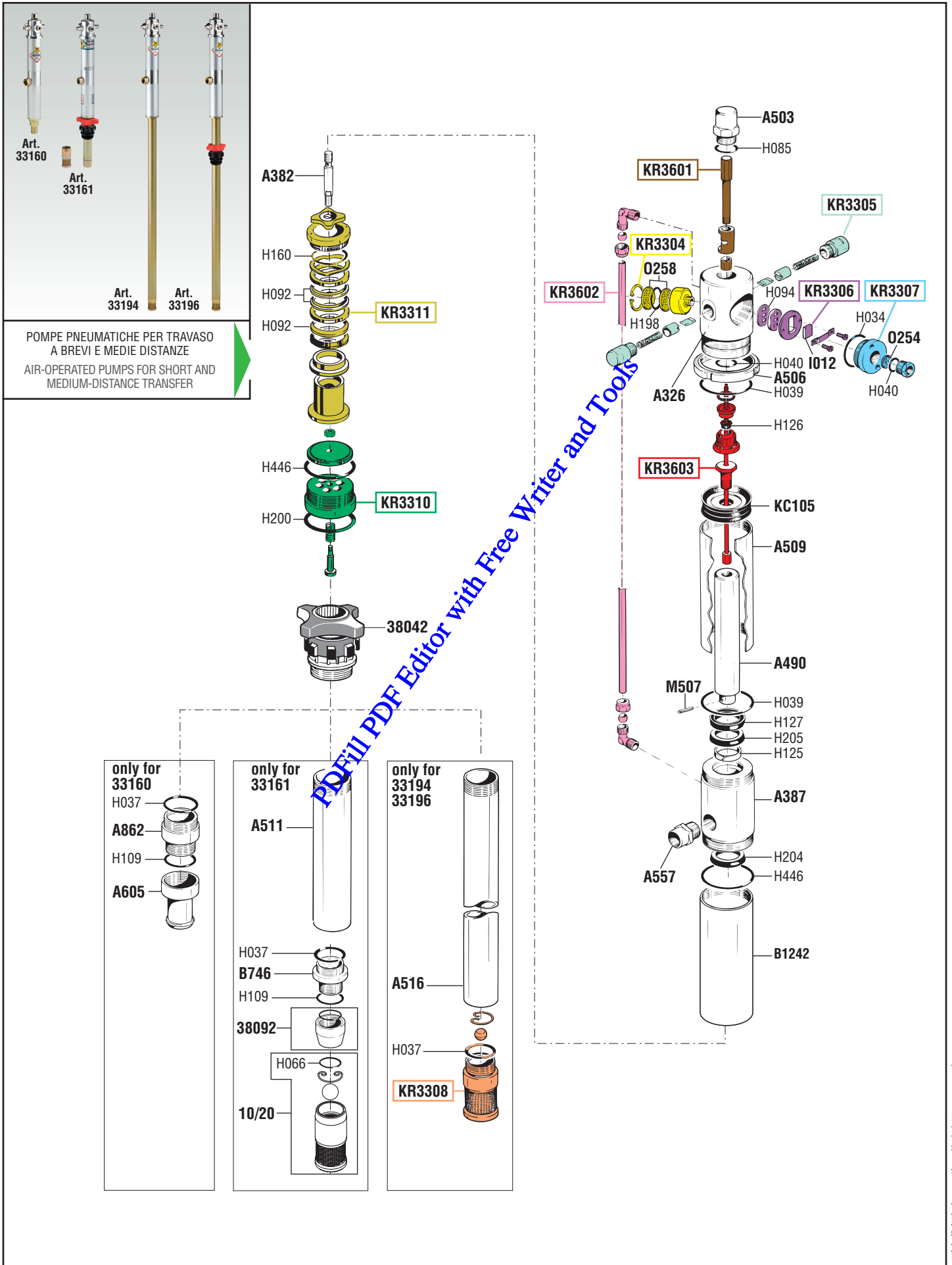

tutti i diritti riservati - all rights reserved

GUIDA RICAMBI - SPARE PARTS GUIDE

KIT RICAMBI OGNI KIT SOTTO RIPORTATO COMPRENDE I RICAMBI EVIDENZIATI CON LO STESSO COLORE E LE RELATIVE GUARNIZIONI. QUESTI RICAMBI NON SONO FORNIBILI SEPARATAMENTE TRANNE QUELLI CODIFICATI.		
SPARE PARTS KITS EACH KIT SHOWN WITH THE SAME COLOR INCLUDES ALSO THE GASKETS. THE SPARE PARTS INCLUDED IN THE KIT CAN'T BE SUPPLIED SEPARATELY EXCEPT THOSE SHOWN WITH A PROPER CODE.		
CODICE CODE	DESCRIZIONE DESCRIPTION	Q. TÀ QTY
KR3304	SILENZIATORE MUFFLER	1
KR3305	DOPPIO GRUPPO INVERTITORE DOUBLE PLUNGER GROUP	1
KR3306	GRUPPO DISTRIBUTORE D'ARIA SLIDE VALVE GROUP	1
KR3307	TAPPO ENTRATA ARIA AIR INLET CONNECTION	1
KR3308	FILTRO PESCANTE SHANK FILTER	1
KR3310	VALVOLA ASPIRAZIONE SUCTION VALVE	1
KR3311	PISTONE ASPIRAZIONE SUCTION PISTON	1
KR3601	SPINGI INVERTITORE SHUTTLE GROUP	1
KR3602	TUBO RICICLO CON RACCORDI TUBE WITH CONNECTIONS	1
KR3603	STELO INVERTITORE ROD	1

ELENCO RICAMBI FORNIBILI SINGOLARMENTE LIST OF SPARE PARTS WHICH CAN BE SUPPLIED SEPARATELY		
CODICE CODE	DESCRIZIONE DESCRIPTION	Q. TÀ QTY
38042	GHIERA DI BLOCCAGGIO ø 42 mm BUNG ADAPTOR ø 42 mm	1
A326	CORPO SUPERIORE MOTORE UPPER MOTOR BODY	1
A382	ALBERO INFERIORE LOWER SPINDLE	1
A387	CORPO INFERIORE LOWER BODY	1
A490	STELO MOTORE MOTOR ROD	1
A503	BOSSOLO GUIDA STELO INVERTITORE PLUNGER	1
A506	GHIERA DI BLOCCAGGIO RING NUT	1
A509	CILINDRO MOTORE MOTOR CYLINDER	1
A511	TUBO PESCANTE Art. 33161 SUCTION TUBE Art. 33161	1
A516	TUBO PESCANTE Art. 33194 - 33196 SUCTION TUBE Art. 33194 - 33196	1
A557	BOCCHETTONE USCITA OUTLET CONNECTION	1
A605	PORTATUBO A RESCA Art. 33160 HOSE HOLDER Art. 33160	1
A862	RACCORDO Art. 33160 UNION Art. 33160	1
B746	PORTA VALVOLA FILETTATO Art. 33161 THREADED TUBE HOLDER Art. 33161	1
B1242	CILINDRO OTTONE ø 67 x 60 BRASS CYLINDER ø 60 x 60	1
M507	SPINA ELASTICA ø 3 x 20 PIN ø 3 x 20	1
10/20	FILTRO VALVOLA PESCANTE FILETTATO 1" SHANK FILTER F 1"	1
38092	RACCORDO SUPERIORE F 1" UPPER CONNECTION F 1"	1

Art. KR3352	KIT GUARNIZIONI COMPLETO COMPOSTO DALLE GUARNIZIONI SOTTO ELENCAE JOINTS GASKETS LIST INCLUDING ALL THE GASKETS SHOWN HERE UNDER	
CODICE CODE	DESCRIZIONE DESCRIPTION	Q. TÀ QTY
H034	O-RING 3156 O-RING 3156	1
H037	O-RING 3137 O-RING 3137	1
H039	O-RING 3225 O-RING 3225	2
H040	O-RING 123 O-RING 123	2
H085	O-RING 2087 O-RING 2087	1
H092	GUARNIZIONE PACCO GRANDE GASKET	3
H094	GUARNIZIONI BASE DISTRIBUTORE GASKET	1
H109	O-RING 3131 O-RING 3131	1
H125	ANELLO GUIDA STELO GUIDE RING	1
H126	GUARNIZIONE ASTA INVERTITORE GASKET	1
H127	GUARNIZIONE GASKET	1
H160	O-RING 2093 O-RING 2093	1
H198	O-RING 3106 O-RING 3106	1
H200	O-RING 3162 O-RING 3162	1
H204	GUARNIZIONE GASKET	1
H205	GUARNIZIONE GASKET	1
H446	O-RING 3225 "VITON" O-RING 3225 "VITON"	2
I012	DISTRIBUTORE ARIA SLIDE VALVE	1
KC105	PISTONE PISTON	1
O254	SILENZIATORE A PASTICCA MUFFLER	1
O258	SILENZIATORE A PASTICCA MUFFLER	2

Art. KS3382	SET RICAMBI CONSIGLIATI AI PUNTI VENDITA E ASSISTENZA, COMPOSTO DAI RICAMBI SOTTO ELENCAE SPARE PARTS KIT ADVISED TO THE REPAIR CENTERS. THIS KIT INCLUDES ALL THE SPARE PARTS SHOWN HERE UNDER	
CODICE CODE	DESCRIZIONE DESCRIPTION	Q. TÀ QTY
A490	STELO MOTORE MOTOR ROD	1
KR3305	DOPPIO GRUPPO INVERTITORE DOUBLE PLUNGER GROUP	1
KR3306	GRUPPO DISTRIBUTORE D'ARIA SLIDE VALVE GROUP	1
KR3352	KIT GUARNIZIONI COMPLETO COMPLETE GASKETS KIT	1
M507	SPINA ELASTICA ø 3 x 20 PIN ø 3 x 20	1

RAASM

FLUIDS AND LUBRICATION EQUIPMENT



Art. 33170 Mod. 1:1/60TV - Art. 33171 Mod. 1:1/60TV
Art. 33172 Mod. 1:1/94TV - Art. 33173 Mod. 1:1/94TV



VISTA ESPLOSA - EXPLODED VIEW

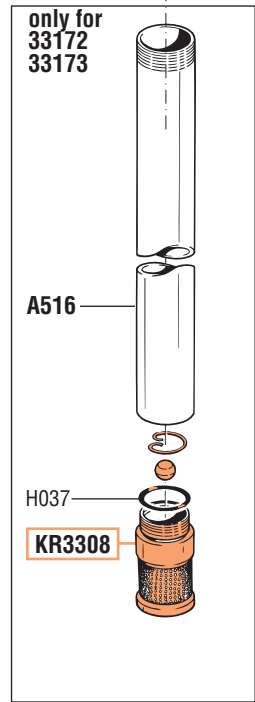
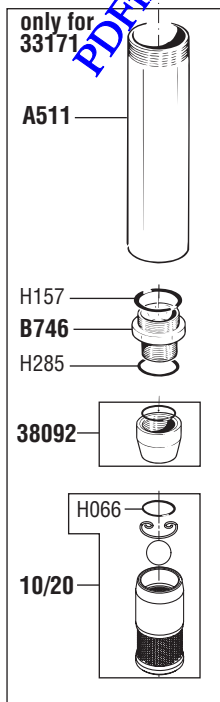
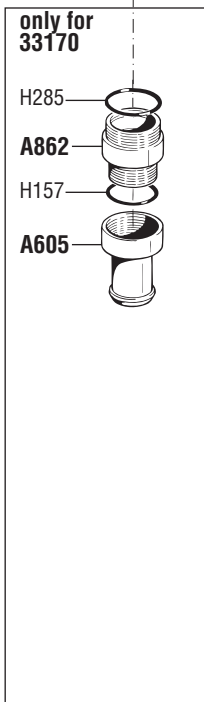
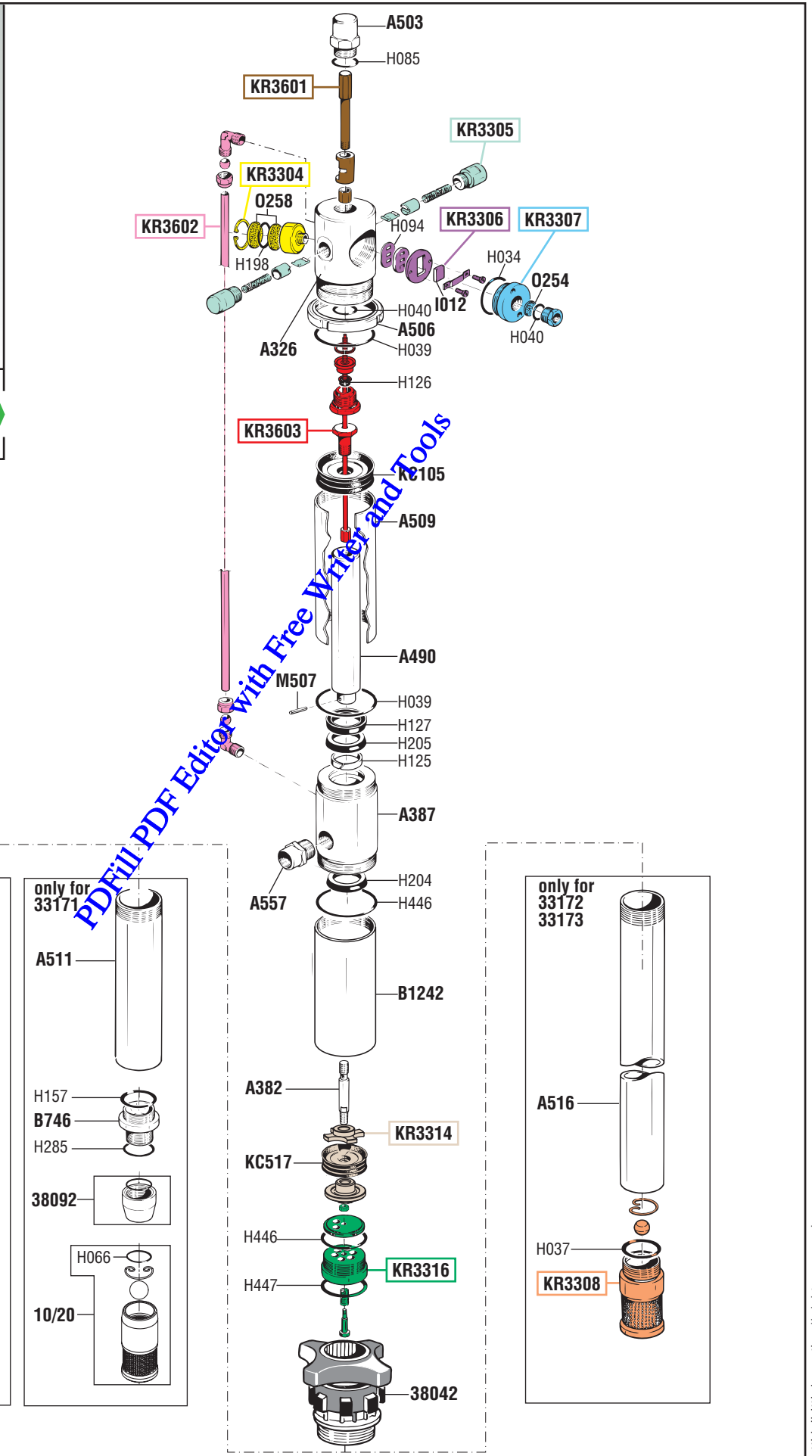
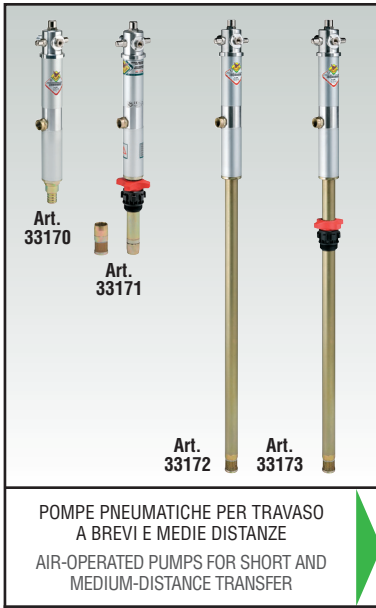

PDFFill PDF Editor With Free Writer and Tools

GUIDA RICAMBI - SPARE PARTS GUIDE

KIT RICAMBI		
OGNI KIT SOTTO RIPORTATO COMPRENDE I RICAMBI EVIDENZIATI CON LO STESSO COLORE E LE RELATIVE GUARNIZIONI. QUESTI RICAMBI NON SONO FORNIBILI SEPARATAMENTE TRANNE QUELLI CODIFICATI.		
SPARE PARTS KITS		
EACH KIT SHOWN WITH THE SAME COLOR INCLUDES ALSO THE GASKETS. THE SPARE PARTS INCLUDED IN THE KIT CAN'T BE SUPPLIED SEPARATELY EXCEPT THOSE SHOWN WITH A PROPER CODE.		
CODICE CODE	DESCRIZIONE DESCRIPTION	Q.TÀ QTY
KR3304	SILENZIATORE MUFFLER	1
KR3305	DOPPIO GRUPPO INVERTITORE DOUBLE PLUNGER GROUP	1
KR3306	GRUPPO DISTRIBUTORE D'ARIA SLIDE VALVE GROUP	1
KR3307	TAPPO ENTRATA ARIA AIR INLET CONNECTION	1
KR3308	FILTRO PESCANTE SHANK FILTER	1
KR3314	PISTONE ASPIRAZIONE SUCTION PUMP	1
KR3316	VALVOLA ASPIRAZIONE SUCTION VALVE	1
KR3601	SPINGI INVERTITORE SHUTTLE GROUP	1
KR3602	TUBO RICICLO CON RACCORDI TUBE WITH CONNECTIONS	1
KR3603	STELO INVERTITORE ROD	1

ELENCO RICAMBI FORNIBILI SINGOLARMENTE		
LIST OF SPARE PARTS WHICH CAN BE SUPPLIED SEPARATELY		
CODICE CODE	DESCRIZIONE DESCRIPTION	Q.TÀ QTY
38042	GHIERA DI BLOCCAGGIO ø 42 mm BUNG ADAPTOR ø 42 mm	1
A326	CORPO SUPERIORE MOTORE UPPER MOTOR BODY	1
A382	ALBERO INFERIORE LOWER SPINDLE	1
A387	CORPO INFERIORE LOWER BODY	1
A490	STELO MOTORE MOTOR ROD	1
A503	BOSSOLO GUIDA STELO INVERTITORE PLUNGER	1
A506	GHIERA DI BLOCCAGGIO RING NUT	1
A509	CILINDRO MOTORE MOTOR CYLINDER	1
A511	TUBO PESCANTE Art. 33171 SUCTION TUBE Art. 33171	1
A516	TUBO PESCANTE Art. 33172 - 33173 SUCTION TUBE Art. 33172 - 33173	1
A557	BOCCHETTONE USCITA OUTLET CONNECTION	1
A605	PORTATUBO A RESCA Art. 33170 HOSE HOLDER Art. 33170	1
A862	RACCORDO Art. 33170 UNION Art. 33170	1
B746	PORTA VALVOLA FILETTATO Art. 33171 THREADED TUBE HOLDER Art. 33171	1
B1242	CILINDRO OTTONE ø 67 x 60 BRASS CYLINDER ø 60 x 60	1
KC517	PISTONE "VITON" PISTON "VITON"	1
M507	SPINA ELASTICA ø 3 x 20 PIN ø 3 x 20	1
10/20	FILTRO VALVOLA PESCANTE FILETTO F 1" SHANK FILTER F 1"	1
38092	RACCORDO SUPERIORE UPPER CONNECTION	1

Art. KR3356		
KIT GUARNIZIONI COMPLETO		
COMPOSTO DALLE GUARNIZIONI SOTTO ELENCAE		
JOINTS GASKETS LIST		
INCLUDING ALL THE GASKETS SHOWN HERE UNDER		
CODICE CODE	DESCRIZIONE DESCRIPTION	Q.TÀ QTY
H034	O-RING 3156 O-RING 3156	1
H037	O-RING 3137 O-RING 3137	1
H039	O-RING 3225 O-RING 3225	2
H040	O-RING 123 O-RING 123	2
H085	O-RING 2087 O-RING 2087	1
H094	GUARNIZIONI BASE DISTRIBUTORE GASKET	1
H125	ANELLO GUIDA STELO GUIDE RING	1
H126	GUARNIZIONE ASTA INVERTITORE GASKET	1
H127	GUARNIZIONE GASKET	1
H157	O-RING 3137 "VITON" O-RING 3137 "VITON"	1
H198	O-RING 3106 O-RING 3106	1
H204	GUARNIZIONE GASKET	1
H205	GUARNIZIONE GASKET	1
H285	O-RING 3131 "VITON" O-RING 3131 "VITON"	1
H446	O-RING 3225 "VITON" O-RING 3225 "VITON"	2
H447	O-RING 3162 "VITON" O-RING 3162 "VITON"	1
I012	DISTRIBUTORE ARIA SLIDE VALVE	1
KC105	PISTONE PISTON	1
O254	SILENZIATORE A PASTICCA MUFFLER	1
O258	SILENZIATORE A PASTICCA MUFFLER	2

Art. KS3385		
SET RICAMBI CONSIGLIATI		
AI PUNTI VENDITA E ASSISTENZA,		
COMPOSTO DAI RICAMBI SOTTO ELENCAE		
SPARE PARTS KIT ADVISED		
TO THE REPAIR CENTERS. THIS KIT INCLUDES		
ALL THE SPARE PARTS SHOWN HERE UNDER		
CODICE CODE	DESCRIZIONE DESCRIPTION	Q.TÀ QTY
A490	STELO MOTORE MOTOR ROD	1
KR3305	DOPPIO GRUPPO INVERTITORE DOUBLE PLUNGER GROUP	1
KR3306	GRUPPO DISTRIBUTORE D'ARIA SLIDE VALVE GROUP	1
KR3356	KIT GUARNIZIONI COMPLETO COMPLETE GASKETS KIT	1
M507	SPINA ELASTICA ø 3 x 20 PIN ø 3 x 20	1

RAASM

FLUIDS AND LUBRICATION EQUIPMENT



Art. 33360 Mod. 1:1/60I - Art. 33396 Mod. 1:1/94I



VISTA ESPLOSA - EXPLODED VIEW

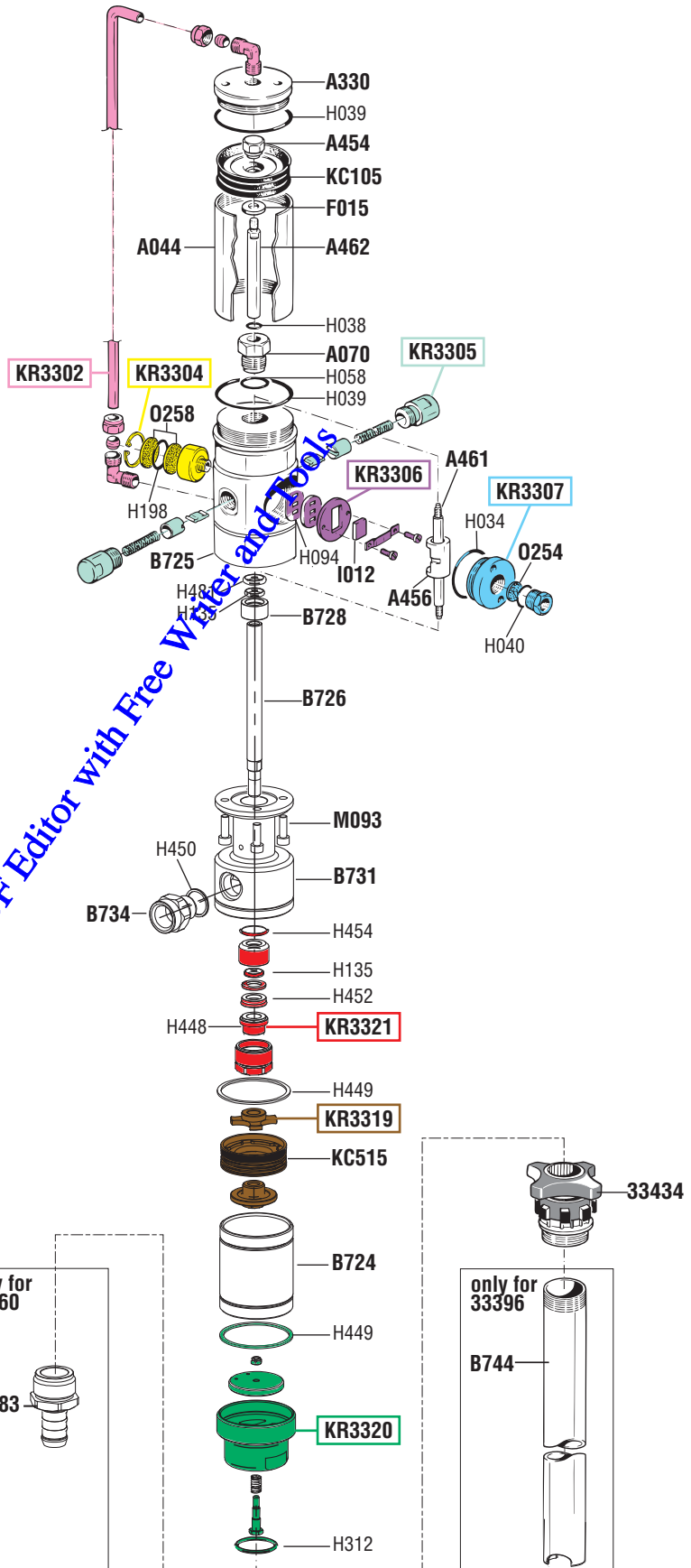
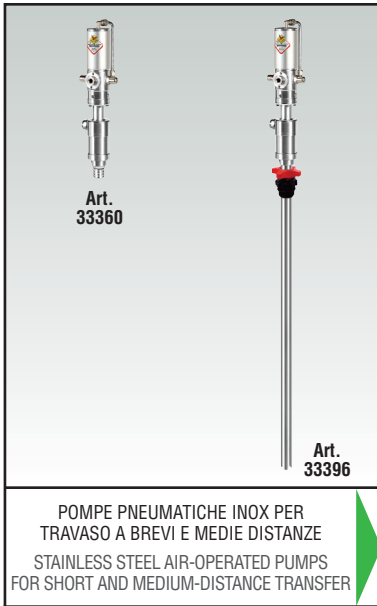

PDFfill PDF Editor with Free Water and Tools

tutti i diritti riservati - all rights reserved



GUIDA RICAMBI - SPARE PARTS GUIDE

KIT RICAMBI OGNI KIT SOTTO RIPORTATO COMPRENDE I RICAMBI EVIDENZIATI CON LO STESSO COLORE E LE RELATIVE GUARNIZIONI. QUESTI RICAMBI NON SONO FORNIBILI SEPARATAMENTE TRANNE QUELLI CODIFICATI.		
SPARE PARTS KITS EACH KIT SHOWN WITH THE SAME COLOR INCLUDES ALSO THE GASKETS. THE SPARE PARTS INCLUDED IN THE KIT CAN'T BE SUPPLIED SEPARATELY EXCEPT THOSE SHOWN WITH A PROPER CODE.		
CODICE CODE	DESCRIZIONE DESCRIPTION	Q.TÀ QTY
KR3302	TUBO RICICLO CON RACCORDI TUBE WITH CONNECTIONS	1
KR3304	SILENZIATORE MUFFLER	1
KR3305	DOPPIO GRUPPO INVERTITORE DOUBLE PLUNGER GROUP	1
KR3306	GRUPPO DISTRIBUTORE D'ARIA SLIDE VALVE GROUP	1
KR3307	TAPPO ENTRATA ARIA AIR INLET CONNECTION	1
KR3319	PISTONE ASPIRAZIONE SUCTION PUMP	1
KR3320	VALVOLA INFERIORE PESCANTE LOW SUCTION TUBE VALVE	1
KR3321	GRUPPO GUARNIZIONI GASKETS GROUP	1

ELENCO RICAMBI FORNIBILI SINGOLARMENTE LIST OF SPARE PARTS WHICH CAN BE SUPPLIED SEPARATELY		
CODICE CODE	DESCRIZIONE DESCRIPTION	Q.TÀ QTY
33434	GHIERA DI BLOCCAGGIO ø 34 mm BUNG ADAPTOR ø 34 mm	1
38083	PORTATUBO A RESCA Art. 33360 HOSE HOLDER Art. 33360	1
A044	CILINDRO MOTORE MOTOR CYLINDER	2
A070	GUIDA STELO ROD GUIDE	1
A330	TESTA MOTORE MOTOR HEAD	1
A454	DADO BLOCCA PISTONE PISTON LOCKING NUT	1
A456	SPINGI INVERTITORE SHUTTLE	1
A461	ALBERO CENTRALE MOTORE MOTOR SPINDLE	1
A462	ALBERO PISTONE MOTORE MOTOR PISTON SPINDLE	1
B724	TUBO PESCANTE SUCTION TUBE	1
B725	CORPO MOTORE POMPA PUMP MOTOR BODY	1
B726	ALBERO INFERIORE LOWER SPINDLE	1
B728	GHIERA RING NUT	1
B731	CORPO PESCANTE SUCTION TUBE BODY	1
B734	ADATTATORE ADAPTOR	1
B744	TUBO PESCANTE Art. 33396 SUCTION TUBE Art. 33396	1
F015	RONDELLA WASHER	1
M093	VITE M6 x 18 SCREW M6 x 18	3

Art. KR3353 KIT GUARNIZIONI COMPLETO COMPOSTO DALLE GUARNIZIONI SOTTO ELENCAE JOINTS GASKETS LIST INCLUDING ALL THE GASKETS SHOWN HERE UNDER		
CODICE CODE	DESCRIZIONE DESCRIPTION	Q.TÀ QTY
H034	O-RING 3156 O-RING 3156	1
H038	O-RING 115 O-RING 115	1
H039	O-RING 3225 O-RING 3225	2
H040	O-RING 123 O-RING 123	1
H058	O-RING 2068 O-RING 2068	1
H094	GUARNIZIONI BASE DISTRIBUTORE GASKET	1
H135	O-RING 115 "VITON" O-RING 115 "VITON"	2
H198	O-RING 3106 O-RING 3106	1
H312	O-RING 3118 "VITON" O-RING 3118 "VITON"	1
H448	ANELLO GUIDA GASKET	1
H449	GUARNIZIONE IN "PTFE" GASKET "PTFE"	2
H450	GUARNIZIONE IN "PTFE" GASKET "PTFE"	1
H452	GUARNIZIONI IN "VITON" GASKETS "VITON"	1
H454	O-RING 2081 "VITON" O-RING 2081 "VITON"	1
H481	O-RING "NBR" O-RING "NBR"	1
I012	DISTRIBUTORE ARIA SLIDE VALVE	1
KC105	PISTONE PISTON	1
KC515	PISTONE VULCANIZZATO VULCANIZED PISTON	1
O254	SILENZIATORE A PASTICCA MUFFLER	1
O258	SILENZIATORE A PASTICCA MUFFLER	2

Art. KS3388 SET RICAMBI CONSIGLIATI AI PUNTI VENDITA E ASSISTENZA, COMPOSTO DAI RICAMBI SOTTO ELENCAE SPARE PARTS KIT ADVISED TO THE REPAIR CENTERS. THIS KIT INCLUDES ALL THE SPARE PARTS SHOWN HERE UNDER		
CODICE CODE	DESCRIZIONE DESCRIPTION	Q.TÀ QTY
B726	ALBERO INFERIORE LOWER SPINDLE	1
KR3305	DOPPIO GRUPPO INVERTITORE DOUBLE PLUNGER GROUP	1
KR3306	GRUPPO DISTRIBUTORE D'ARIA SLIDE VALVE GROUP	1
KR3353	KIT GUARNIZIONI COMPLETO COMPLETE GASKETS KIT	1

RAASM

FLUIDS AND LUBRICATION EQUIPMENT



Art. 33445 - Art. 33446



VISTA ESPLOSA - EXPLODED VIEW



PISTOLA PER ANTIGELO E LIQUIDO LAVAVETRI S.1/2" - 40AN
 GUN FOR ANTIFREEZE AND WINDSHIELD WASHING LIQUID S.1/2" - 40AN

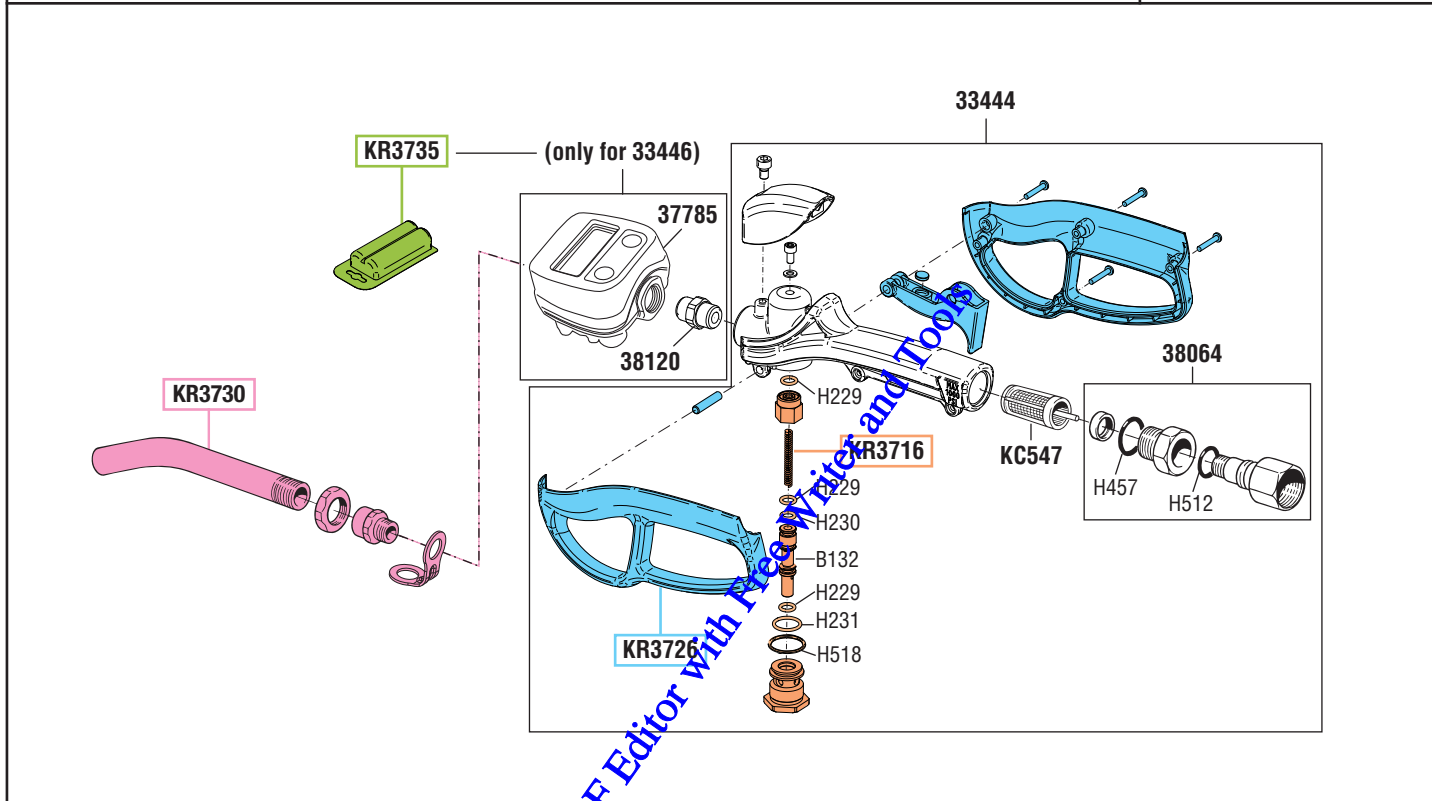

tutti i diritti riservati - all rights reserved

GUIDA RICAMBI - SPARE PARTS GUIDE

KIT RICAMBI
 OGNI KIT SOTTO RIPORTATO COMPRENDE I RICAMBI EVIDENZIATI CON LO STESSO COLORE E LE RELATIVE GUARNIZIONI. QUESTI RICAMBI NON SONO FORNIBILI SEPARATAMENTE TRANNE QUELLI CODIFICATI.

SPARE PARTS KITS
 EACH KIT SHOWN WITH THE SAME COLOR INCLUDES ALSO THE GASKETS. THE SPARE PARTS INCLUDED IN THE KIT CAN'T BE SUPPLIED SEPARATELY EXCEPT THOSE SHOWN WITH A PROPER CODE.

CODICE CODE	DESCRIZIONE DESCRIPTION	Q.TÀ QTY
KR3716	VALVOLA PISTOLA OLIO OIL GUN VALVE	1
KR3726	CORPO COMPLETO PISTOLA OLIO OIL GUN COMPLETE BODY	1
KR3730	TERMINALE ALTA PORTATA HIGH CAPACITY TERMINAL	1
KR3735	KIT 2 BATTERIE "AAA" 1.5V (only for 33446) "AAA" 1.5v BATTERY KITS (only for 33446)	1

ELENCO RICAMBI FORNIBILI SINGOLARMENTE
 LIST OF SPARE PARTS WHICH CAN BE SUPPLIED SEPARATELY

CODICE CODE	DESCRIZIONE DESCRIPTION	Q.TÀ QTY
33444	IMPUGNATURA IN LEGA DI ALLUMINIO GRIP IN ALLUMINIUM ALLOY	1
37785	CONTALITRI DIGITALE 1/2" LIQUIDO LAVAVETRI/ANTIGELO DIGITAL ANTIFREEZE/WINDSHIELD WASHING LIQUID METER	1
38064	SNODO OTTONE GIREVOLE SWIVEL BRASS JOINT	1
38120	NIPPLE M 1/2" G X M 3/8" G INOX AISI 304 NIPPLE M 1/2" G X M 3/8" G INOX AISI 304	1
KC547	FILTRO PISTOLA 3/8" FILTER GUN 3/8"	1

Art. KR3761 KIT GUARNIZIONI COMPLETO
 COMPOSTO DALLE GUARNIZIONI SOTTO ELENCAE JOINTS GASKETS LIST INCLUDING ALL THE GASKETS SHOWN HERE UNDER

CODICE CODE	DESCRIZIONE DESCRIPTION	Q.TÀ QTY
B132	SPILLO VALVOLA VALVE PIN	1
H229	O-RING 106 "VITON" O-RING 106 "VITON"	3
H230	O-RING 2025 90 SH "VITON" O-RING 2025 90 SH "VITON"	1
H231	O-RING 2056 "VITON" O-RING 2056 "VITON"	1
H457	O-RING 123 "VITON" O-RING 123 "VITON"	1
H512	O-RING 2050 "VITON 90SH" O-RING 2050 "VITON 90SH"	1
H518	O-RING 2068 "VITON" O-RING 2068 "VITON"	1
KC547	FILTRO FILTER	1

Art. KS3789 SET RICAMBI CONSIGLIATI
 AI PUNTI VENDITA E ASSISTENZA, COMPOSTO DAI RICAMBI SOTTO ELENCAE TO THE REPAIR CENTERS. THIS KIT INCLUDES ALL THE SPARE PARTS SHOWN HERE UNDER

SPARE PARTS KIT ADVISED

CODICE CODE	DESCRIZIONE DESCRIPTION	Q.TÀ QTY
KR3716	VALVOLA PISTOLA OLIO OIL GUN VALVE	1
KR3761	KIT GUARNIZIONI COMPLETO COMPLETE GASKETS KIT	1

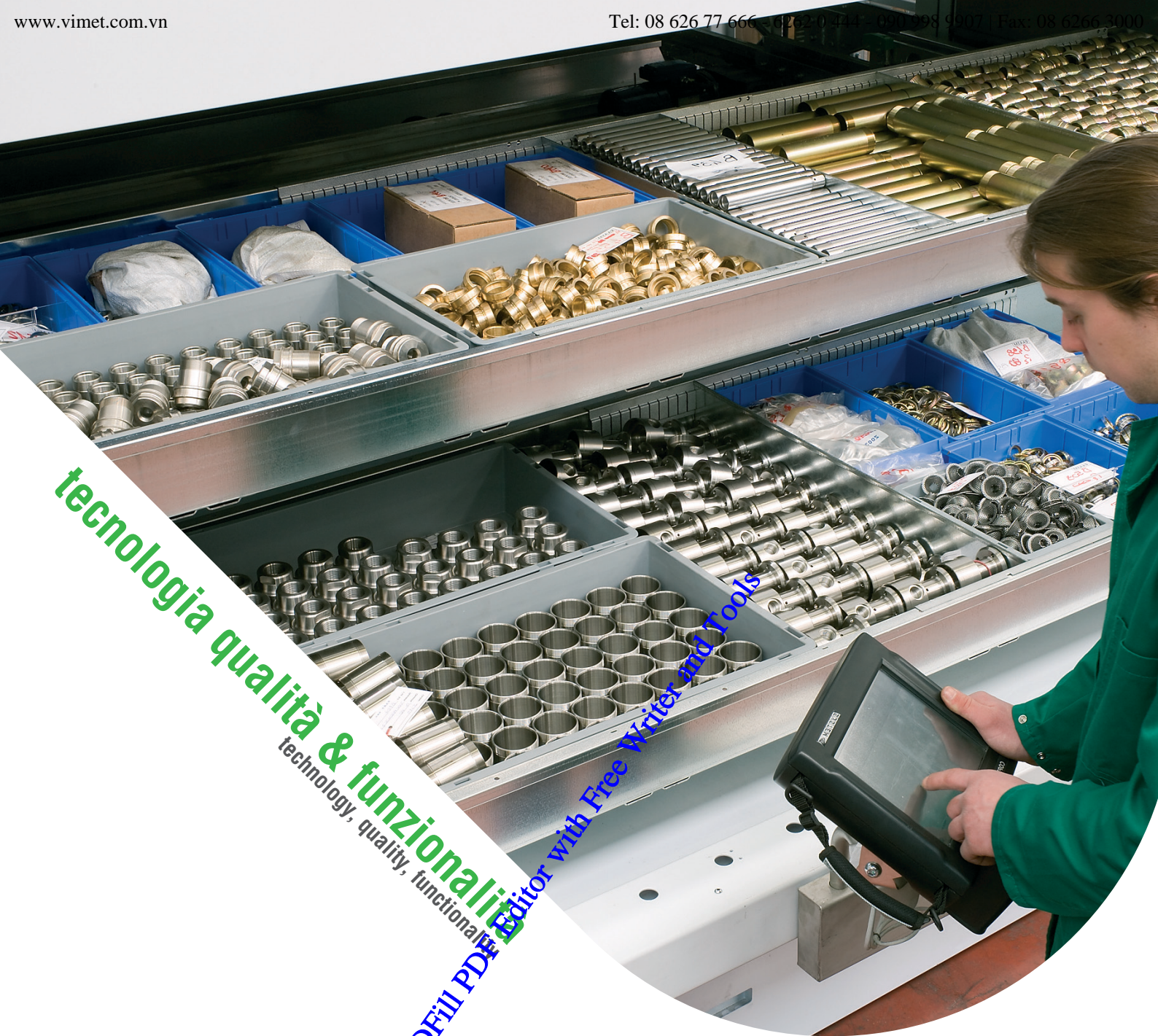

tecnologia qualità & funzionalità
technology, quality, functionality

PDFFill PDF Editor with Free Writer and Tools

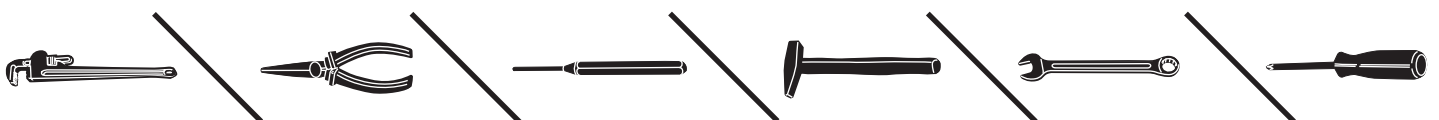



Art. 33500 Mod. 3/4" NBR 7094
Art. 33505 Mod. 3/4" NBR 70124



VISTA ESPLOSA - EXPLODED VIEW

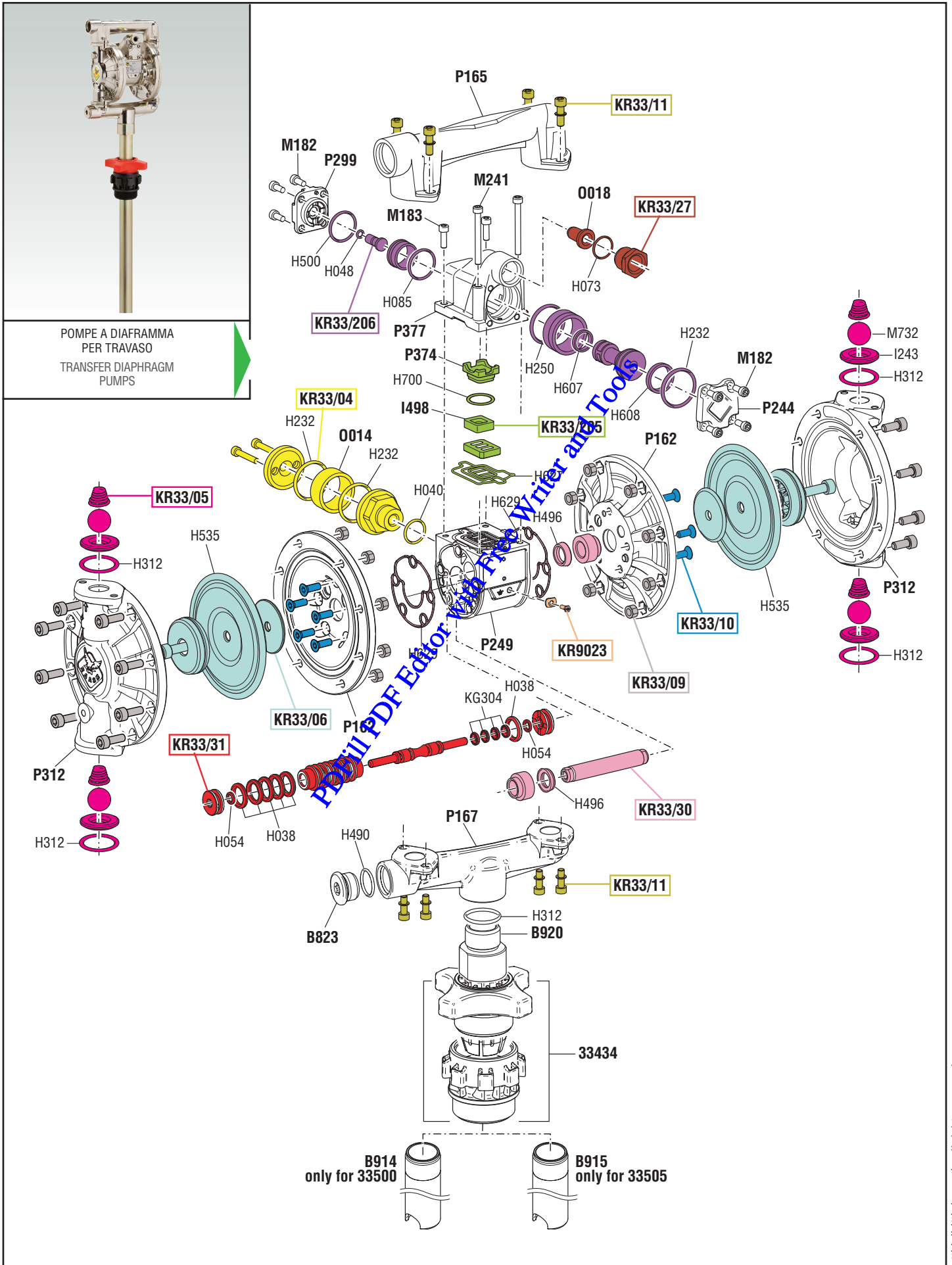

tutti i diritti riservati - all rights reserved



GUIDA RICAMBI - SPARE PARTS GUIDE

KIT RICAMBI OGNI KIT SOTTO RIPORTATO COMPRENDE I RICAMBI EVIDENZIATI CON LO STESSO COLORE E LE RELATIVE GUARNIZIONI. QUESTI RICAMBI NON SONO FORNIBILI SEPARATAMENTE TRAMME QUELLI CODIFICATI.		
SPARE PARTS KITS EACH KIT SHOWN WITH THE SAME COLOR INCLUDES ALSO THE GASKETS. THE SPARE PARTS INCLUDED IN THE KIT CAN'T BE SUPPLIED SEPARATELY EXCEPT THOSE SHOWN WITH A PROPER CODE.		
CODICE CODE	DESCRIZIONE DESCRIPTION	Q.TÀ QTY
KR33/04	SILENZIATORE MUFFLER	1
KR33/05	GRUPPO VALVOLE VALVE GROUP	1
KR33/06	GRUPPO MEMBRANE "NBR" DIAPHRAM GROUP "NBR"	1
KR33/09	VITERIA FLANGE FLANGES SCREWS	1
KR33/10	VITERIE MOTORE MOTOR SCREWS	1
KR33/11	VITERIE COLLETTORI MANIFOLDS SCREWS	1
KR33/27	ENTRATA ARIA AIR INLET	1
KR33/206	GRUPPO INVERTITORE AIR SWITCH KIT	1
KR33/205	GRUPPO DISTRIBUTORE DISTRIBUTOR KIT	1
KR33/30	GRUPPO ALBERO PISTONE PISTON SHAFT GROUP	1
KR33/31	GRUPPO PERNO PILOTA PILOT PIN GROUP	1
KR9023	MESSA A TERRA GROUNDED	1

ELENCO RICAMBI FORNIBILI SINGOLARMENTE LIST OF SPARE PARTS WHICH CAN BE SUPPLIED SEPARATELY		
CODICE CODE	DESCRIZIONE DESCRIPTION	Q.TÀ QTY
33434	GHIERA DI BLOCCAGGIO ø 34 mm BUNG ADAPTOR ø 34 mm	1
B823	TAPPO COLLETTORE 3/4" MANIFOLD PLUG 3/4"	1
B914	TUBO PESCANTE 940 mm SUCTION TUBE 940 mm	1
B915	TUBO PESCANTE 1240 mm SUCTION TUBE 1240 mm	1
B920	RACCORDO CONNECTOR	1
H490	O-RING 130 "VITON" O-RING 130 "VITON"	1
H312	O-RING 3118 "VITON" O-RING 3118 "VITON"	1
H700	GUARNIZIONE DISTRIBUTORE SEAL DISTRIBUTOR	1
I243	SEDE VALVOLA "HYTREL" SEAT VALVE "HYTREL"	1
I386	DISTRIBUTORE ARIA AIR DISTRIBUTOR	1
I498	PASTIGLIA DISTRIBUTORE INFERIORE LOWER TABLET DISPENSER	1
M182	VITE INOX M5 x 12 STAINLESS STEEL SCREW M5 x 12	2
M183	VITE INOX M5 x 16 STAINLESS STEEL SCREW M5 x 16	2
M241	VITE INOX M5 x 50 STAINLESS STEEL SCREW M5 x 50	2
M732	SFERA VALVOLA "HYTREL" BALL VALVE "HYTREL"	2
0014	SILENZIATORE MUFFLER	1
0018	FILTRO ENTRATA ARIA AIR INLET FILTER	1
P162	FLANGIA INTERNA INTERNAL FLANGE	2
P165	COLLETTORE SUPERIORE OUTLET MANIFOLD	1
P167	COLLETTORE INFERIORE INLET MANIFOLD	1
P244	COPERCHIO COVER	1
P249	CORPO CENTRALE CENTRAL BODY	1
P299	COPERCHIO COVER	1
P312	FLANGIA ESTERNA EXTERNAL FLANGE	2
P374	PASTIGLIA DISTRIBUTORE SUPERIORE UPPER TABLET DISPENSER	2
P377	CORPO DISTRIBUTORE AIR DISTRIBUTOR BODY	1

KIT GUARNIZIONI COMPLETO COMPOSTO DALLE GUARNIZIONI SOTTO ELENCAE JOINTS GASKETS LIST INCLUDING ALL THE GASKETS SHOWN HERE UNDER		
CODICE CODE	DESCRIZIONE DESCRIPTION	Q.TÀ QTY
KR33/58	KIT GUARNIZIONI DISTRIBUTORE ARIA AIR DISTRIBUTOR GASKETS KIT	1
KR33/59	KIT GUARNIZIONI CORPO MOTORE MOTOR GASKETS KIT	1
KR33/76	KIT GUARNIZIONI VALVOLE/MEMBRANE VALVE/DIAPHRAM GASKETS KIT	1

Art. KS33/82 SET RICAMBI CONSIGLIATI AI PUNTI VENDITA E ASSISTENZA, COMPOSTO DAI RICAMBI SOTTO ELENCAE SPARE PARTS KIT ADVISED TO THE REPAIR CENTERS, THIS KIT INCLUDES ALL THE SPARE PARTS SHOWN HERE UNDER		
CODICE CODE	DESCRIZIONE DESCRIPTION	Q.TÀ QTY
KR33/05	GRUPPO VALVOLE VALVE GROUP	1
KR33/54	KIT GUARNIZIONI VALVOLE/MEMBRANE VALVE/DIAPHRAM GASKETS KIT	1
KR33/58	KIT GUARNIZIONI DISTRIBUTORE ARIA AIR DISTRIBUTOR GASKETS KIT	1
KR33/59	KIT GUARNIZIONI CORPO MOTORE MOTOR GASKETS KIT	1



Art. 33550



VISTA ESPLOSA - EXPLODED VIEW

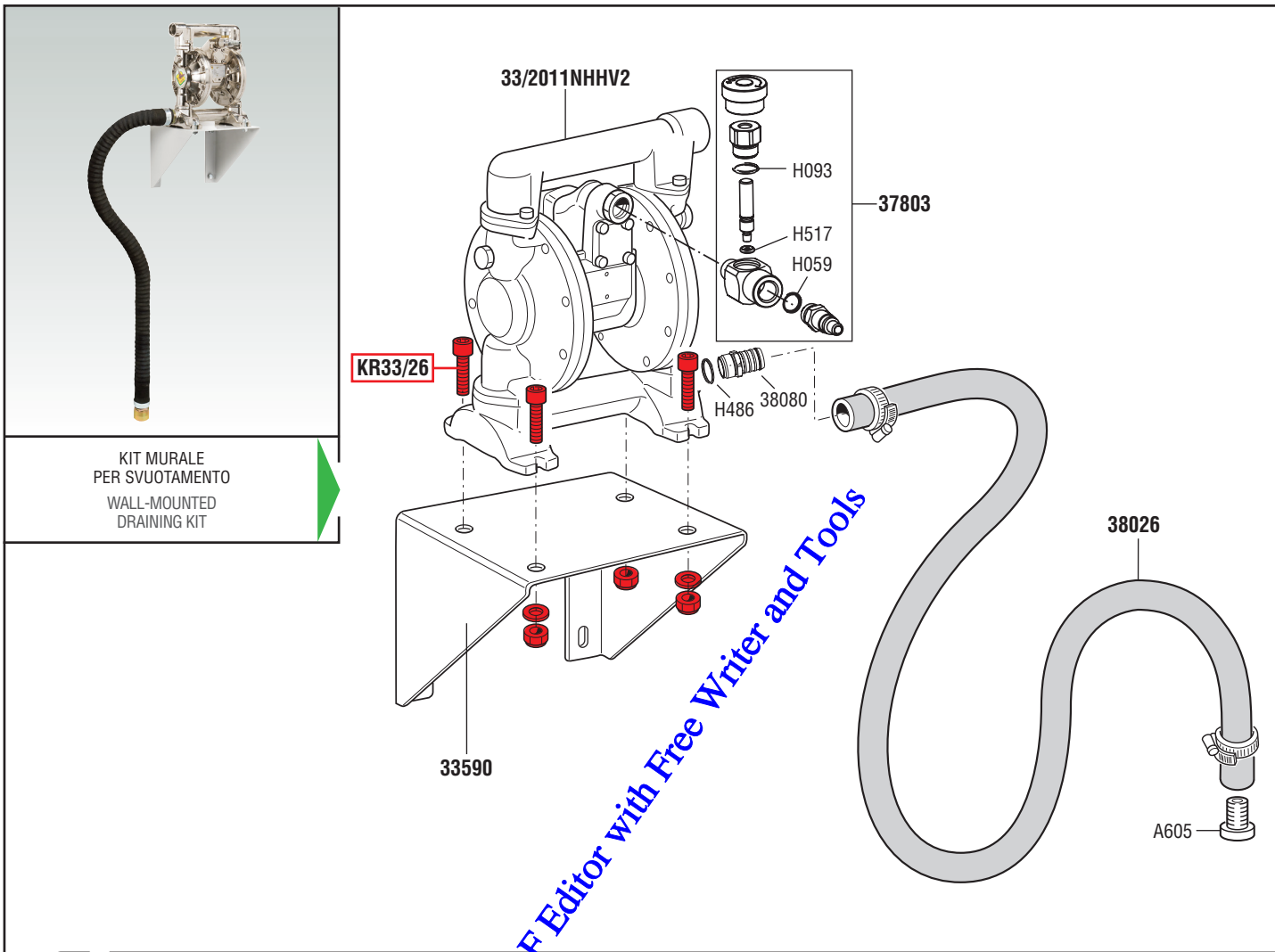

KIT MURALE
PER SVUOTAMENTO
WALL-MOUNTED
DRAINING KIT

GUIDA RICAMBI - SPARE PARTS GUIDE

KIT RICAMBI

OGNI KIT SOTTO RIPORTATO COMPRENDE I RICAMBI EVIDENZIATI CON LO STESSO COLORE E LE RELATIVE GUARNIZIONI. QUESTI RICAMBI NON SONO FORNIBILI SEPARATAMENTE TRANNE QUELLI CODIFICATI.

SPARE PARTS KITS

EACH KIT SHOWN WITH THE SAME COLOR INCLUDES ALSO THE GASKETS. THE SPARE PARTS INCLUDED IN THE KIT CAN'T BE SUPPLIED SEPARATELY EXCEPT THOSE SHOWN WITH A PROPER CODE.

CODICE CODE	DESCRIZIONE DESCRIPTION	Q.TÀ QTY
KR33/26	VITERIA SCREWS	1

ELENCO RICAMBI FORNIBILI SINGOLARMENTE

LIST OF SPARE PARTS WHICH CAN BE SUPPLIED SEPARATELY

CODICE CODE	DESCRIZIONE DESCRIPTION	Q.TÀ QTY
33/2011NHHV2	POMPA A DIAFRAMMA S. 3/4" DIAPHRAGM PUMP S. 3/4"	1
33590	STAFFA MURALE WALL BRACKET	1
37803	KIT REGOLAZIONE FLUSSO ARIA AIR FLOW REGULATOR KIT	1
38026	TUBO PESCANTE FLESSIBILE FLEXIBLE SUCTION HOSE	1
38080	PORTATUBO A RESCA HOSE HOLDER	1
A605	PORTATUBO A RESCA HOSE HOLDER	1
H059	O-RING 2037 O-RING 2037	1
H093	O-RING 2050 "VITON" O-RING 2050 "VITON"	1
H517	O-RING 2018 "VITON" O-RING 2018 "VITON"	1
H486	O-RING 3093 "VITON" O-RING 3093 "VITON"	1

SET RICAMBI CONSIGLIATI

AI PUNTI VENDITA E ASSISTENZA, COMPOSTO DAI RICAMBI SOTTO ELENCATI

SPARE PARTS KIT ADVISED

TO THE REPAIR CENTERS. THIS KIT INCLUDES ALL THE SPARE PARTS SHOWN HERE UNDER

CODICE CODE	DESCRIZIONE DESCRIPTION	Q.TÀ QTY
KS33/82	SET RICAMBI CONSIGLIATI POMPA PUMP SPARE PARTS KIT ADVISED	1

tutti i diritti riservati - all rights reserved



Art. 33710 Mod. D.V.3/4”G



VISTA ESPLOSA - EXPLODED VIEW

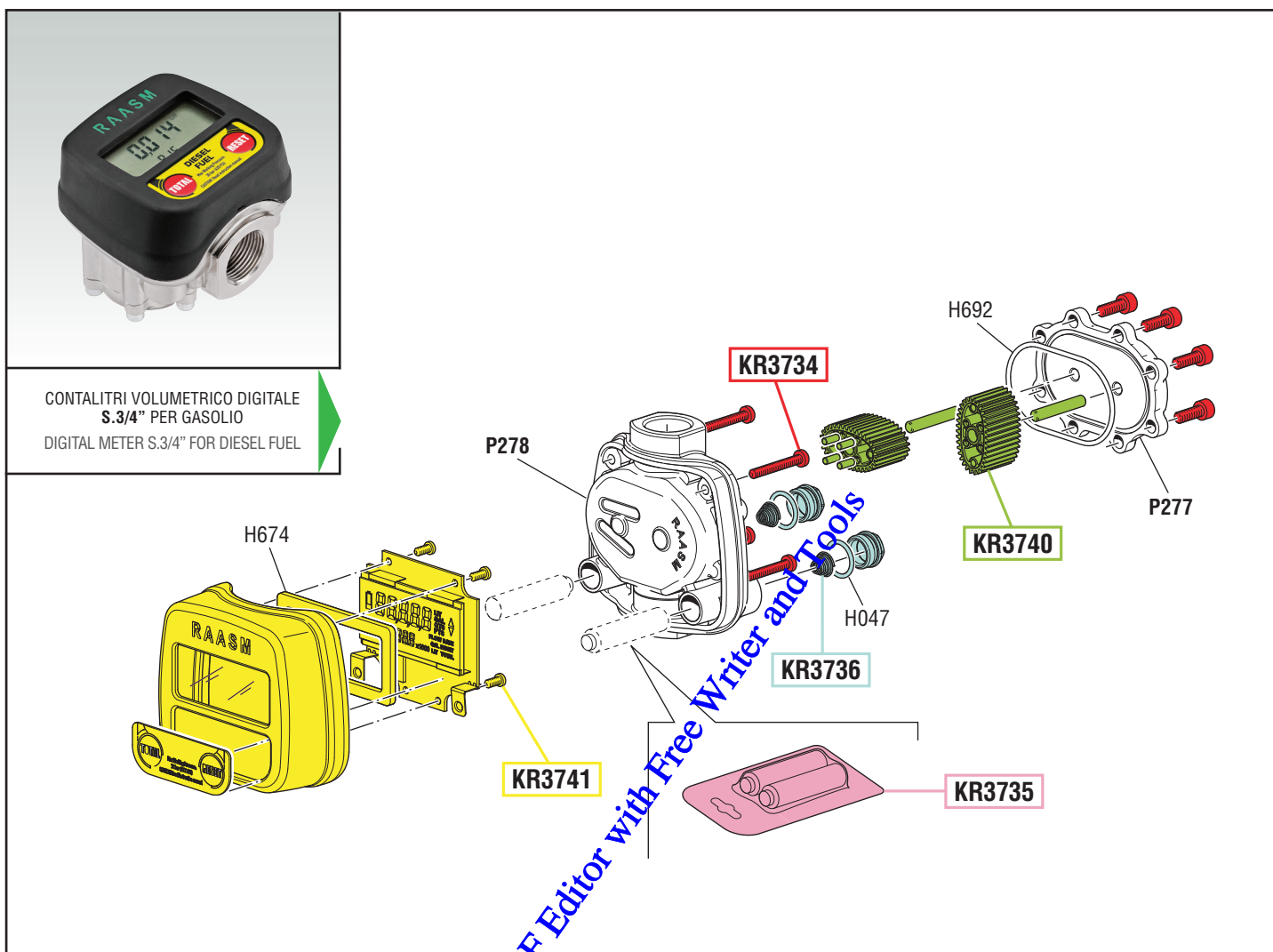

tutti i diritti riservati - all rights reserved

GUIDA RICAMBI - SPARE PARTS GUIDE

KIT RICAMBI
OGNI KIT SOTTO RIPORTATO COMPRENDE I RICAMBI EVIDENZIATI CON LO STESSO COLORE E LE RELATIVE GUARNIZIONI. QUESTI RICAMBI NON SONO FORNIBILI SEPARATAMENTE TRANNE QUELLI CODIFICATI.

SPARE PARTS KITS
EACH KIT SHOWN WITH THE SAME COLOR INCLUDES ALSO THE GASKETS. THE SPARE PARTS INCLUDED IN THE KIT CAN'T BE SUPPLIED SEPARATELY EXCEPT THOSE SHOWN WITH A PROPER CODE.

CODICE CODE	DESCRIZIONE DESCRIPTION	Q.TÀ QTY
KR3734	SET VITI SET OF SCREWS	1
KR3735	BATTERIE MINI STILO TIPO "AAA" 1,5V BATTERIES 1,5 SIZE "AAA"	1
KR3736	GRUPPO TAPPI ERMETICI BATTERIA HERMETIC BATTERY PLUGS GROUP	1
KR3739	GRUPPO INGRANAGGI OVALI-POM (DEL RIN 100P) OVAL GEARS GROUP-POM (DEL RIN 100P)	1
KR3741	GRUPPO COPERCHIO DISPLAY-CIRCUITO STAMPATO PROTECTIVE COVER-ELECTRONICS BOARD	1

ELENCO RICAMBI FORNIBILI SINGOLARMENTE
LIST OF SPARE PARTS WHICH CAN BE SUPPLIED SEPARATELY

CODICE CODE	DESCRIZIONE DESCRIPTION	Q.TÀ QTY
P277	COPERCHIO PER CORPO CONTALITRI BODY DIGITAL METER COVER	1
P278	CORPO CONTALITRI ALLUMINIUM DIGITAL METER BODY	1

Art. KR3760
KIT GUARNIZIONI COMPLETO
COMPOSTO DALLE GUARNIZIONI SOTTO ELENCAE
JOINTS GASKETS LIST
INCLUDING ALL THE GASKETS SHOWN HERE UNDER

CODICE CODE	DESCRIZIONE DESCRIPTION	Q.TÀ QTY
H047	GUARNIZIONE OR 2050 "NBR" O-RING 2050 "NBR"	2
H674	GUARNIZIONE PER DISPLAY DISPLAY GASKET	1
H692	GUARNIZIONE "NBR" O-RING "NBR"	1



Art. 35060 Mod. 3:1/5060 - Art. 35061 Mod. 3:1/5061
Art. 35063 Mod. 3:1/5063 - Art. 35076 Mod. 3:1/5074 - Art. 35094 Mod. 3:1/5094



VISTA ESPLOSA - EXPLODED VIEW

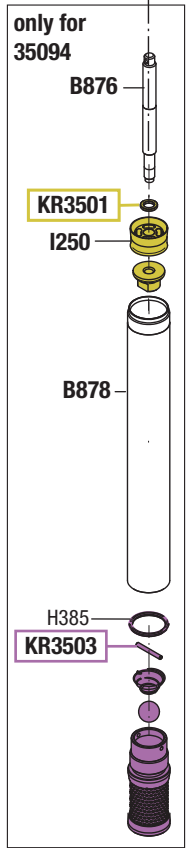
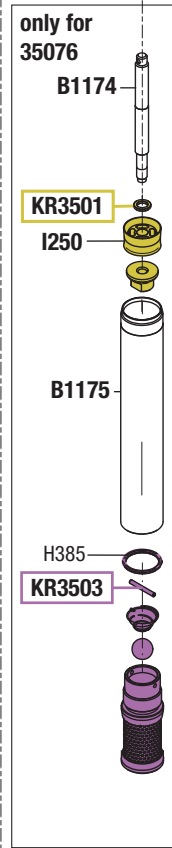
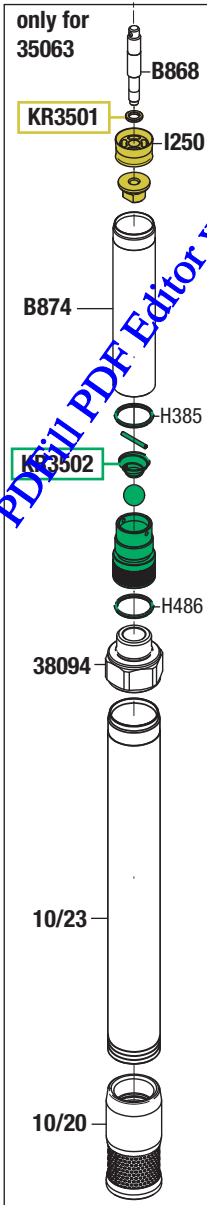
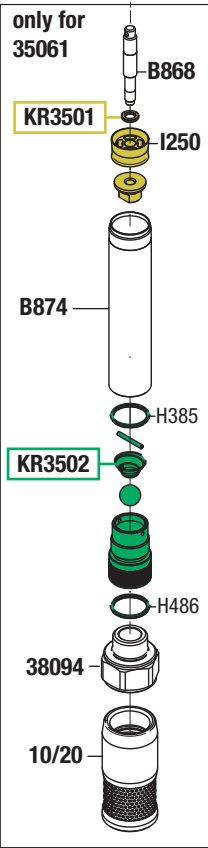
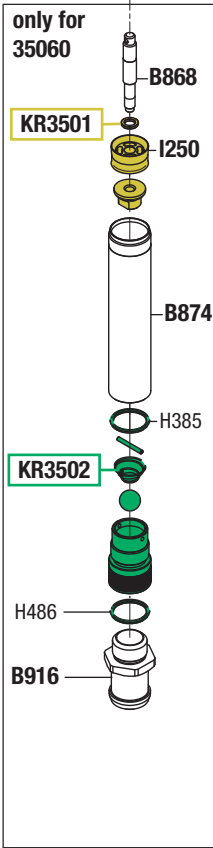
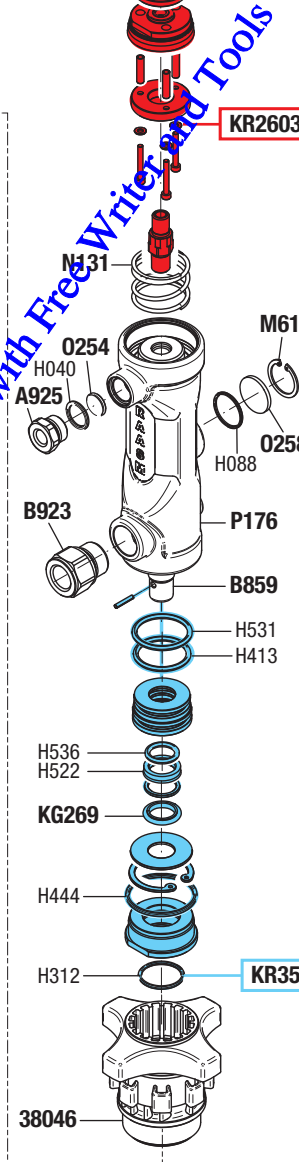
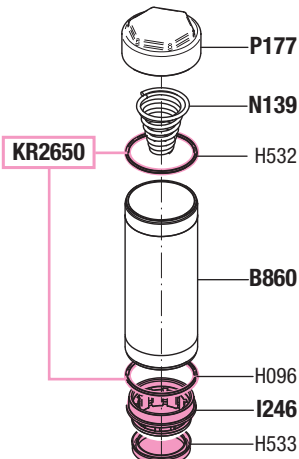
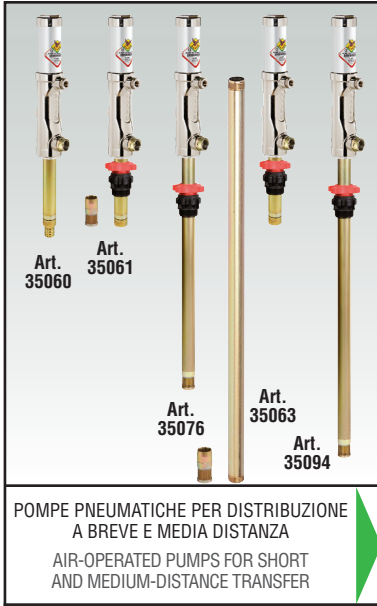

tutti i diritti riservati - all rights reserved

GUIDA RICAMBI - SPARE PARTS GUIDE

KIT RICAMBI OGNI KIT SOTTO RIPORTATO COMPRENDE I RICAMBI EVIDENZIATI CON LO STESSO COLORE E LE RELATIVE GUARNIZIONI. QUESTI RICAMBI NON SONO FORNIBILI SEPARATAMENTE TRANNE QUELLI CODIFICATI.		
SPARE PARTS KITS EACH KIT SHOWN WITH THE SAME COLOR INCLUDES ALSO THE GASKETS. THE SPARE PARTS INCLUDED IN THE KIT CAN'T BE SUPPLIED SEPARATELY EXCEPT THOSE SHOWN WITH A PROPER CODE.		
CODICE CODE	DESCRIZIONE DESCRIPTION	Q. TÀ QTY
KR2603	GRUPPO PISTONE MOTORE POMPANTE PUMPING MOTOR PISTON GROUP	1
KR2650	GR. TRAVASO ARIA SLIDE VALVE GROUP	1
KR3501	PISTONE POMPANTE PUMPING PISTON	1
KR3502	VALVOLA FONDO PESCANTE BOTTOM VALVE	1
KR3503	VALVOLA FONDO PESCANTE BOTTOM VALVE	1
KR3551	PACCO GUARNIZIONI GASKETS SET	1

ELENCO RICAMBI FORNIBILI SINGOLARMENTE LIST OF SPARE PARTS WHICH CAN BE SUPPLIED SEPARATELY		
CODICE CODE	DESCRIZIONE DESCRIPTION	Q. TÀ QTY
10/20	VALVOLA FONDO PESCANTE Art. 35061 BOTTOM VALVE Art. 35061	1
10/23	PROLUNGA PESCANTE 960 mm Art. 35063 SUCTION TUBE EXTENSION 960 mm Art.35063	1
38046	GHIERA DI BLOCCAGGIO ø 32 mm BUNG ADAPTOR ø 32 mm	1
38094	ADATTATORE PER PROLUNGA ADAPTOR FOR EXTENSION	1
A925	ADATTATORE M 1/2" G x F 1/4" G ADAPTOR M 1/2" G x F 1/4" G	1
B859	PISTONE BASCULANTE PISTON	1
B860	TUBO PISTONE PISTON TUBE	1
B868	STELO POMPANTE Art. 35060 - 35061 - 35063 PUMPING ROD Art. 35060 - 35061 - 35063	1
B874	TUBO PESCANTE Art. 35060 - 35061 - 35063 SUCTION TUBE Art. 35060 - 35061 - 35063	1
B876	STELO POMPANTE Art. 35094 PUMPING ROD Art. 35094	1
B878	TUBO PESCANTE Art. 35094 SUCTION TUBE Art. 35094	1
B916	PORTATUBO A RESCA Art. 35060 HOSE HOLDER Art. 35060	1
B923	RACCORDO CONNECTOR	1
B1174	STELO POMPANTE Art. 35076 PUMPING ROD Art. 35076	1
B1175	TUBO PESCANTE Art. 35076 SUCTION TUBE Art. 35076	1
I246	ANELLO TRAVASO ARIA SLIDE VALVE RING	1
M618	ANELLO SEEGER ø 30 mm SEEGER RING ø 30 mm	1
N131	MOLLA SPRING	1
N139	MOLLA CONICA CONIC SPRING	1
P176	CORPO POMPA PUMP BODY	1
P177	TAPPO POMPA PUMP PLUG	1

Art. KR3357 KIT GUARNIZIONI COMPLETO COMPOSTO DALLE GUARNIZIONI SOTTO ELENCAE JOINTS GASKETS LIST INCLUDING ALL THE GASKETS SHOWN HERE UNDER		
CODICE CODE	DESCRIZIONE DESCRIPTION	Q. TÀ QTY
H040	O-RING 123 O-RING 123	1
H088	O-RING 2106 "NBR 70" O-RING 2106 "NBR 70"	1
H096	O-RING 3168 O-RING 3168	1
H312	O-RING 3118 "VITON" O-RING 3118 "VITON"	1
H385	O-RING 3100 "VITON" O-RING 3100 "VITON"	1
H413	O-RING 4150 "VITON" O-RING 4150 "VITON"	1
H444	O-RING 3193 "VITON" O-RING 3193 "VITON"	1
H486	O-RING 3093 "VITON" O-RING 3093 "VITON"	1
H522	GUARNIZIONE "VITON" GASKET "VITON"	1
H531	O-RING 4143 "VITON" O-RING 4143 "VITON"	1
H532	O-RING O-RING	1
H533	GUARNIZIONE GASKET	1
H536	O-RING 4075 "VITON" O-RING 4075 "VITON"	1
I250	PISTONE POMPANTE PUMPING PISTON	1
KG269	ANELLO DI TENUTA "TEFLON-VITON" GASKET "TEFLON-VITON"	1
O254	SILENZIATORE A PASTICCA MUFFLER	1
O258	SILENZIATORE A PASTICCA MUFFLER	1

Art. KS3386 SET RICAMBI CONSIGLIATI AI PUNTI VENDITA E ASSISTENZA. COMPOSTO DAI RICAMBI SOTTO ELENCAE SPARE PARTS KIT ADVISED TO THE REPAIR CENTERS. THIS KIT INCLUDES ALL THE SPARE PARTS SHOWN HERE UNDER		
CODICE CODE	DESCRIZIONE DESCRIPTION	Q. TÀ QTY
KR2603	GRUPPO PISTONE MOTORE POMPANTE PUMPING MOTOR PISTON GROUP	1
KR3357	KIT GUARNIZIONI COMPLETO COMPLETE GASKETS KIT	1
N131	MOLLA SPRING	1
N139	MOLLA CONICA CONIC SPRING	1



Art. 35160 Mod. 3:1/60 - Art. 35161 Mod. 3:1/60 - Art. 35163 Mod. 3:1/1250
Art. 35173 Mod. 3:1/73 - Art. 35176 Mod. 3:1/73 - Art. 35194 Mod. 3:1/94
Art. 35196 Mod. 3:1/94



VISTA ESPLOSA - EXPLODED VIEW

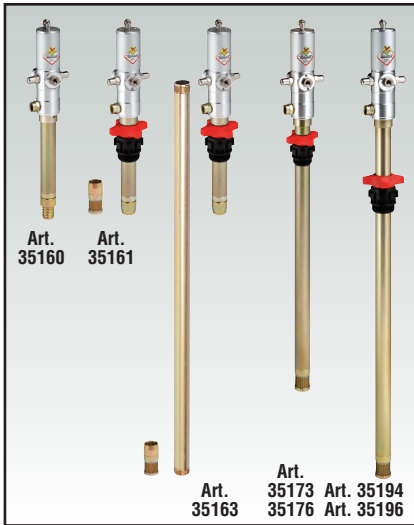

Art. 35160
Art. 35161

Art. 35163
Art. 35173 Art. 35194
Art. 35176 Art. 35196

POMPE PNEUMATICHE PER DISTRIBUZIONE
A BREVI E MEDIE DISTANZE
AIR-OPERATED PUMPS FOR SHORT
AND MEDIUM-DISTANCE TRANSFER

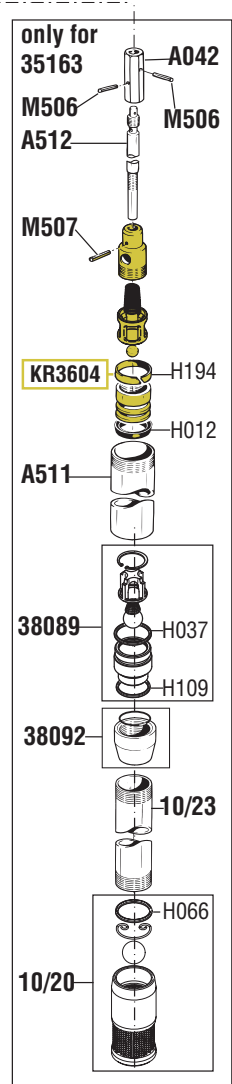
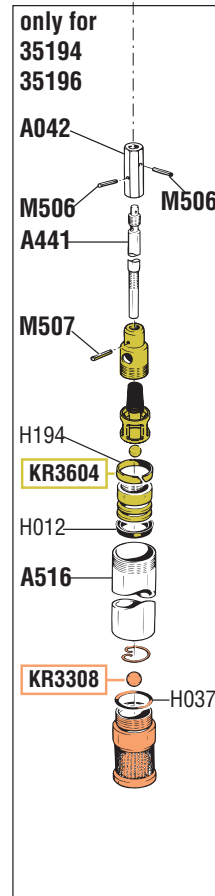
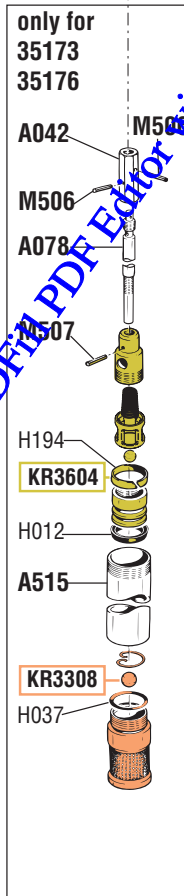
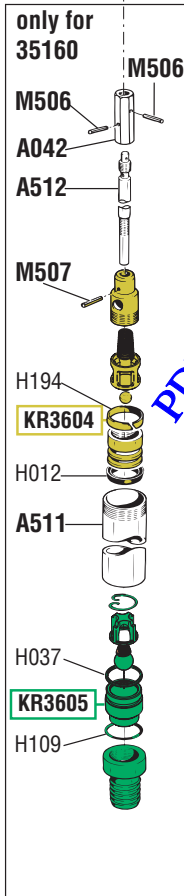
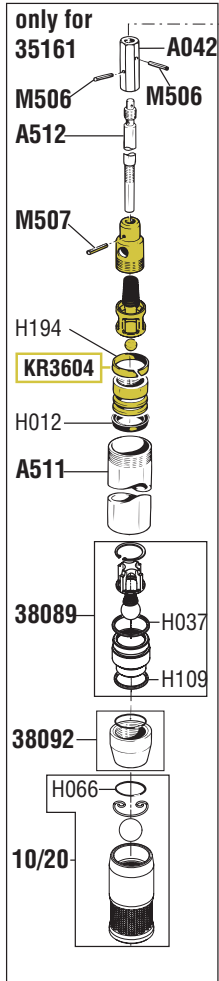
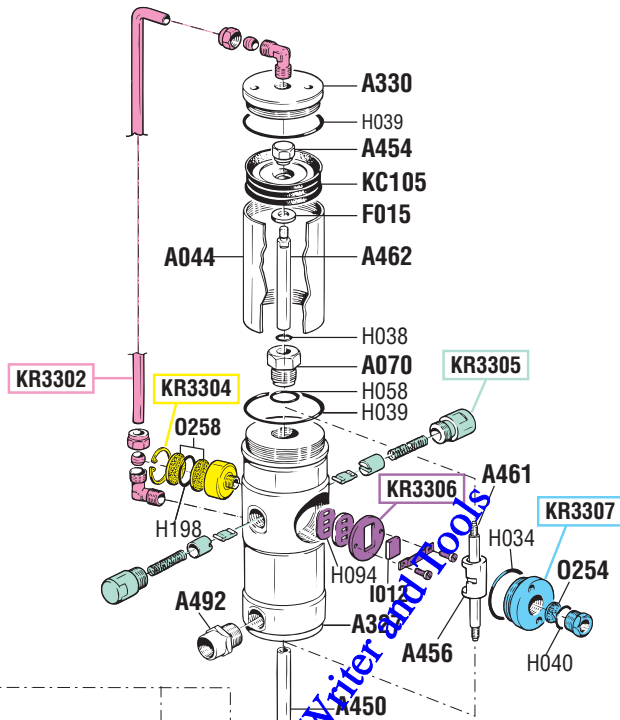

PDF Editor with Free Writer and Tools

tutti i diritti riservati - all rights reserved

GUIDA RICAMBI - SPARE PARTS GUIDE

KIT RICAMBI
OGNI KIT SOTTO RIPORTATO COMPRENDE I RICAMBI EVIDENZIATI CON LO STESSO COLORE E LE RELATIVE GUARNIZIONI. QUESTI RICAMBI NON SONO FORNIBILI SEPARATAMENTE TRANNE QUELLI CODIFICATI.

SPARE PARTS KITS

EACH KIT SHOWN WITH THE SAME COLOR INCLUDES ALSO THE GASKETS. THE SPARE PARTS INCLUDED IN THE KIT CAN'T BE SUPPLIED SEPARATELY EXCEPT THOSE SHOWN WITH A PROPER CODE.

CODICE CODE	DESCRIZIONE DESCRIPTION	Q.TÀ QTY
KR3302	TUBO RICICLO CON RACCORDI TUBE WITH CONNECTIONS	1
KR3304	SILENZIATORE MUFFLER	1
KR3305	DOPPIO GRUPPO INVERTITORE DOUBLE PLUNGER GROUP	1
KR3306	GRUPPO DISTRIBUTORE D'ARIA SLIDE VALVE GROUP	1
KR3307	TAPPO ENTRATA ARIA AIR INLET CONNECTION	1
KR3308	FILTRO PESCANTE SHANK FILTER	1
KR3604	PISTONE POMPANTE OLIO OIL PUMPING PISTON	1
KR3605	VALVOLA FONDO PESCANTE (Art. 35160) BOTTOM VALVE (Art. 35160)	1
KR6203	GUARNIZIONI PACCO-RONDELLA SET OF GASKETS WITH WASHER	1

ELENCO RICAMBI FORNIBILI SINGOLARMENTE

LIST OF SPARE PARTS WHICH CAN BE SUPPLIED SEPARATELY

CODICE CODE	DESCRIZIONE DESCRIPTION	Q.TÀ QTY
10/20	VALVOLA FONDO PESCANTE Art. 35163 - 35161 BOTTOM VALVE Art. 35163 - 35161	1
10/23	PROLUNGA PESCANTE 960 mm Art. 35163 SUCTION TUBE EXTENSION 960 mm Art. 35163	1
38042	GHERA DI BLOCCAGGIO ø 42 mm BUNG ADAPTOR ø 42 mm	1
38089	VALVOLA FONDO PESCANTE BOTTOM VALVE	1
38092	RACCORDO SUPERIORE F 1" UPPER CONNECTION F 1"	1
A042	GIUNTO MOTORE POMPANTE PUMPING ELEMENT JOINT	1
A044	CILINDRO MOTORE MOTOR CYLINDER	1
A070	GUIDA STELO ROD GUIDE	1
A078	STELO POMPANTE Art. 35173 PUMPING ROD Art. 35173	1
A327	CORPO MOTORE MOTOR BODY	1
A330	TESTA MOTORE MOTOR HEAD	1
A441	STELO POMPANTE Art. 35194 PUMPING ROD Art. 35194	1
A450	ALBERO INFERIORE MOTORE MOTOR SPINDLE	1
A454	DADO BLOCCA PISTONE PISTON LOCKING NUT	1
A456	SPINGI INVERTITORE SHUTTLE	1
A460	GIUNTO TUBO PESCANTE CONNECTION	1
A461	ALBERO CENTRALE MOTORE MOTOR SPINDLE	1
A462	ALBERO PISTONE MOTORE MOTOR PISTON SPINDLE	1
A492	ADATTATORE M 1/2" G x 1/2" G ADAPTOR M 1/2" G x 1/2" G	1
A511	TUBO PESCANTE Art. 35161 - 35160 - 35163 SUCTION TUBE Art. 35161 - 35160 - 35163	1
A512	STELO POMPANTE PUMPING ROD	1
A515	TUBO PESCANTE Art. 35173 SUCTION TUBE Art. 35173	1
A516	TUBO PESCANTE Art. 35194 SUCTION TUBE Art. 35194	1
F015	RONDELLA WASHER	1
F179	RONDELLA FERMO MOLLA WASHER	1
M506	SPINA ELASTICA ø 3 x 14 PIN ø 3 x 14	2
M507	SPINA ELASTICA ø 3 x 20 PIN ø 3 x 20	1
M031	MOLLA PREMI PACCO SPRING	1

Art. KR3550
KIT GUARNIZIONI COMPLETO
COMPOSTO DALLE GUARNIZIONI SOTTO ELENCAE
JOINTS GASKETS LIST
INCLUDING ALL THE GASKETS SHOWN HERE UNDER

CODICE CODE	DESCRIZIONE DESCRIPTION	Q.TÀ QTY
H012	GUARNIZIONE GASKET	1
H024	GUARNIZIONI PACCO GASKET	4
H034	O-RING 3156 O-RING 3156	1
H037	O-RING 3137 O-RING 3137	1
H038	O-RING 115 O-RING 115	1
H039	O-RING 3225 O-RING 3225	2
H040	O-RING 123 O-RING 123	1
H058	O-RING 2068 O-RING 2068	1
H066	O-RING 3118 O-RING 3118	1
H094	GUARNIZIONI BASE DISTRIBUTORE GASKET	1
H109	O-RING 3131 O-RING 3131	1
H194	ANELLO GUIDA PISTONE POMPA PISTON GUIDE RING	1
H198	O-RING 3106 O-RING 3106	1
H200	O-RING 3162 O-RING 3162	1
I012	DISTRIBUTORE ARIA SLIDE VALVE	1
KC105	PISTONE PISTON	1
O254	SILENZIATORE A PASTICCA MUFFLER	1
O258	SILENZIATORE A PASTICCA MUFFLER	2

Art. KS3580
SET RICAMBI CONSIGLIATI
AI PUNTI VENDITA E ASSISTENZA,
COMPOSTO DAI RICAMBI SOTTO ELENCAE
SPARE PARTS KIT ADVISED
TO THE REPAIR CENTERS. THIS KIT INCLUDES
ALL THE SPARE PARTS SHOWN HERE UNDER

CODICE CODE	DESCRIZIONE DESCRIPTION	Q.TÀ QTY
A450	ALBERO INFERIORE MOTORE MOTOR SPINDLE	1
KR3305	DOPPIO GRUPPO INVERTITORE DOUBLE PLUNGER GROUP	1
KR3306	GRUPPO DISTRIBUTORE D'ARIA SLIDE VALVE GROUP	1
KR3550	KIT GUARNIZIONI COMPLETO COMPLETE GASKETS KIT	1
M506	SPINA ELASTICA ø 3 x 14 PIN ø 3 x 14	2
M507	SPINA ELASTICA ø 3 x 20 PIN ø 3 x 20	1

RAASM

FLUIDS AND LUBRICATION EQUIPMENT



Art. 35179 Mod. 3:1/79 - Art. 35180 Mod. 3:1/80



VISTA ESPLOSA - EXPLODED VIEW



POMPE SVUOTAMENTO
SERBATOIO DA 100 l
AIR-OPERATED PUMPS FOR
EMPTYING 100 l TANK

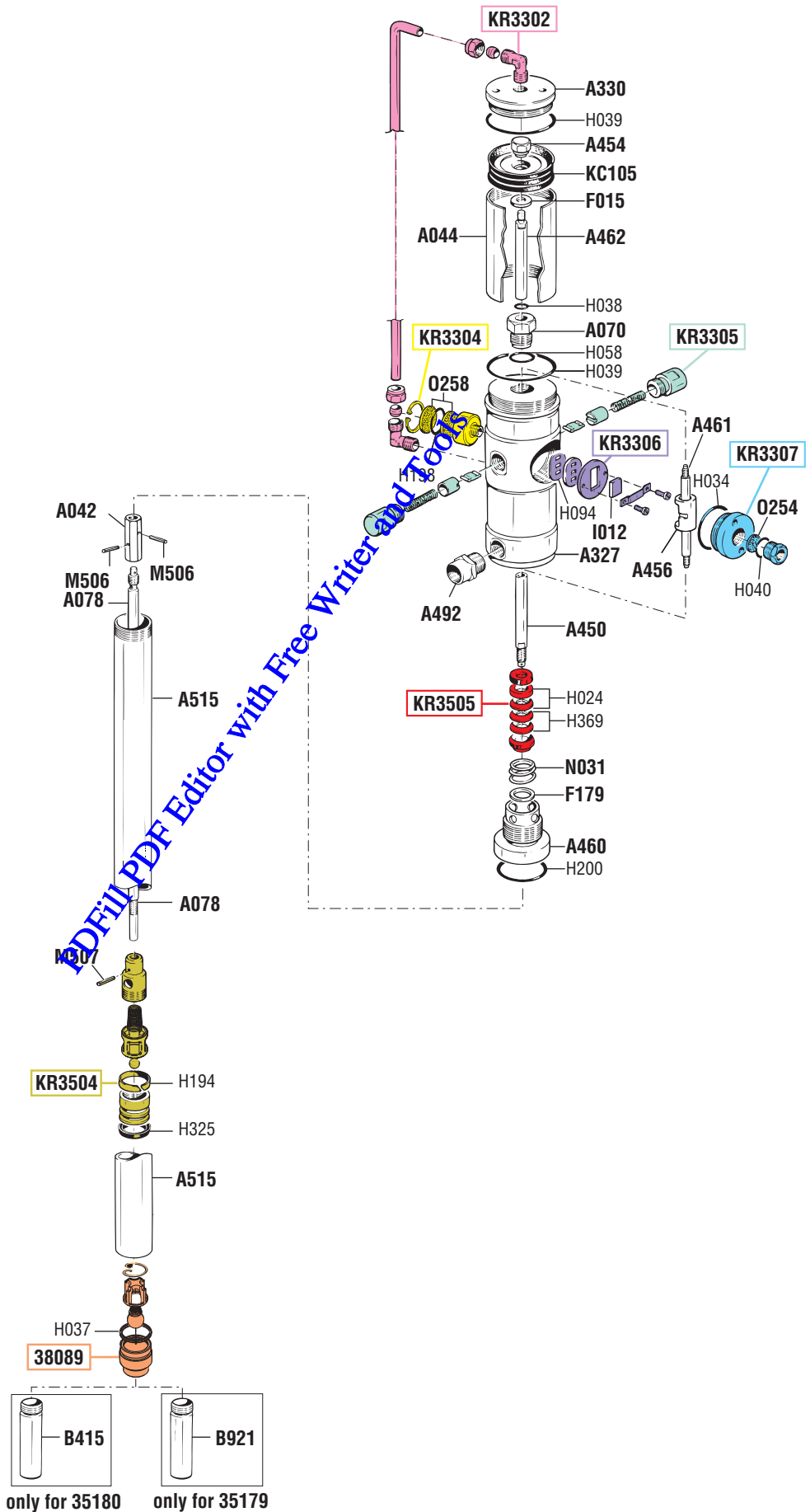

tutti i diritti riservati - all rights reserved



GUIDA RICAMBI - SPARE PARTS GUIDE

KIT RICAMBI OGNI KIT SOTTO RIPORTATO COMPRENDE I RICAMBI EVIDENZIATI CON LO STESSO COLORE E LE RELATIVE GUARNIZIONI. QUESTI RICAMBI NON SONO FORNIBILI SEPARATAMENTE TRANNE QUELLI CODIFICATI.		
SPARE PARTS KITS EACH KIT SHOWN WITH THE SAME COLOR INCLUDES ALSO THE GASKETS. THE SPARE PARTS INCLUDED IN THE KIT CAN'T BE SUPPLIED SEPARATELY EXCEPT THOSE SHOWN WITH A PROPER CODE.		
CODICE CODE	DESCRIZIONE DESCRIPTION	Q. TÀ QTY
38089	VALVOLA FONDO PESCANTE BOTTOM VALVE	1
KR3302	TUBO RICICLO CON RACCORDI TUBE WITH CONNECTIONS	1
KR3304	SILENZIATORE MUFFLER	1
KR3305	DOPPIO GRUPPO INVERTITORE DOUBLE PLUNGER GROUP	1
KR3306	GRUPPO DISTRIBUTORE D'ARIA SLIDE VALVE GROUP	1
KR3307	TAPPO ENTRATA ARIA AIR INLET CONNECTION	1
KR3504	PISTONE POMPANTE OLIO ESAUSTO WASTE OIL PUMPING PISTON	1
KR3505	GUARNIZIONI PACCO-RONDELLA SET OF GASKETS WITH WASHER	1

ELENCO RICAMBI FORNIBILI SINGOLARMENTE LIST OF SPARE PARTS WHICH CAN BE SUPPLIED SEPARATELY		
CODICE CODE	DESCRIZIONE DESCRIPTION	Q. TÀ QTY
A042	GIUNTO MOTORE POMPANTE PUMPING ELEMENT JOINT	1
A044	CILINDRO MOTORE MOTOR CYLINDER	1
A070	GUIDA STELO ROD GUIDE	1
A078	STELO POMPANTE PUMPING ROD	1
A327	CORPO MOTORE MOTOR BODY	1
A330	TESTA MOTORE MOTOR HEAD	1
A450	ALBERO INFERIORE MOTORE MOTOR SPINDLE	1
A454	DADO BLOCCA PISTONE PISTON LOCKING NUT	1
A456	SPINGI INVERTITORE SHUTTLE	1
A460	GIUNTO TUBO PESCANTE CONNECTION	1
A461	ALBERO CENTRALE MOTORE MOTOR SPINDLE	1
A462	ALBERO PISTONE MOTORE MOTOR PISTON SPINDLE	1
A492	ADATTATORE M 1/2" G x F 1/2" G ADAPTOR M 1/2" G x F 1/2" G	1
A515	TUBO PESCANTE SUCTION TUBE	1
B415	PROLUNGA Art. 35180 EXTENSION Art. 35180	1
B921	TUBO PROLUNGHE Art. 35179 TUBE Art. 35179	1
F015	RONDELLA WASHER	1
F179	RONDELLA FERMO MOLLA WASHER	1
M506	SPINA ELASTICA ø 3 x 14 PIN ø 3 x 14	2
M507	SPINA ELASTICA ø 3 x 20 PIN ø 3 x 20	1
N031	MOLLA PREMIA SPRING	1

Art. KR3552	KIT GUARNIZIONI COMPLETO COMPOSTO DALLE GUARNIZIONI SOTTO ELENCAE JOINTS GASKETS LIST INCLUDING ALL THE GASKETS SHOWN HERE UNDER	
CODICE CODE	DESCRIZIONE DESCRIPTION	Q. TÀ QTY
H325	GUARNIZIONE "VITON" GASKET "VITON"	1
H024	GUARNIZIONI PACCO GASKET	1
H034	O-RING 3156 O-RING 3156	1
H037	O-RING 3137 O-RING 3137	1
H038	O-RING 115 O-RING 115	1
H039	O-RING 3225 O-RING 3225	2
H040	O-RING 123 O-RING 123	1
H058	O-RING 2068 O-RING 2068	1
H094	GUARNIZIONI BASE DISTRIBUTORE GASKET	1
H194	ANELLO GUIDA PISTONE POMPA PISTON GUIDE RING	1
H198	O-RING 3106 O-RING 3106	1
H200	O-RING 3162 O-RING 3162	1
H369	GUARNIZIONE INFERIORE PACCO MOTOR MOTOR LOWER GASKET	3
I012	DISTRIBUTORE ARIA SLIDE VALVE	1
KC105	PISTONE PISTON	1
O254	SILENZIATORE A PASTICCA MUFFLER	1
O258	SILENZIATORE A PASTICCA MUFFLER	2

Art. KS3581	SET RICAMBI CONSIGLIATI AI PUNTI VENDITA E ASSISTENZA, COMPOSTO DAI RICAMBI SOTTO ELENCAE SPARE PARTS KIT ADVISED TO THE REPAIR CENTERS. THIS KIT INCLUDES ALL THE SPARE PARTS SHOWN HERE UNDER	
CODICE CODE	DESCRIZIONE DESCRIPTION	Q. TÀ QTY
A450	ALBERO INFERIORE MOTORE MOTOR SPINDLE	1
KR3305	DOPPIO GRUPPO INVERTITORE DOUBLE PLUNGER GROUP	1
KR3306	GRUPPO DISTRIBUTORE D'ARIA SLIDE VALVE GROUP	1
KR3552	KIT GUARNIZIONI COMPLETO COMPLETE GASKETS KIT	1
M506	SPINA ELASTICA ø 3 x 14 PIN ø 3 x 14	2
M507	SPINA ELASTICA ø 3 x 20 PIN ø 3 x 20	1



Art. 35265 - Art. 35270 - Art. 37650 - Art. 37670



VISTA ESPLOSA - EXPLODED VIEW

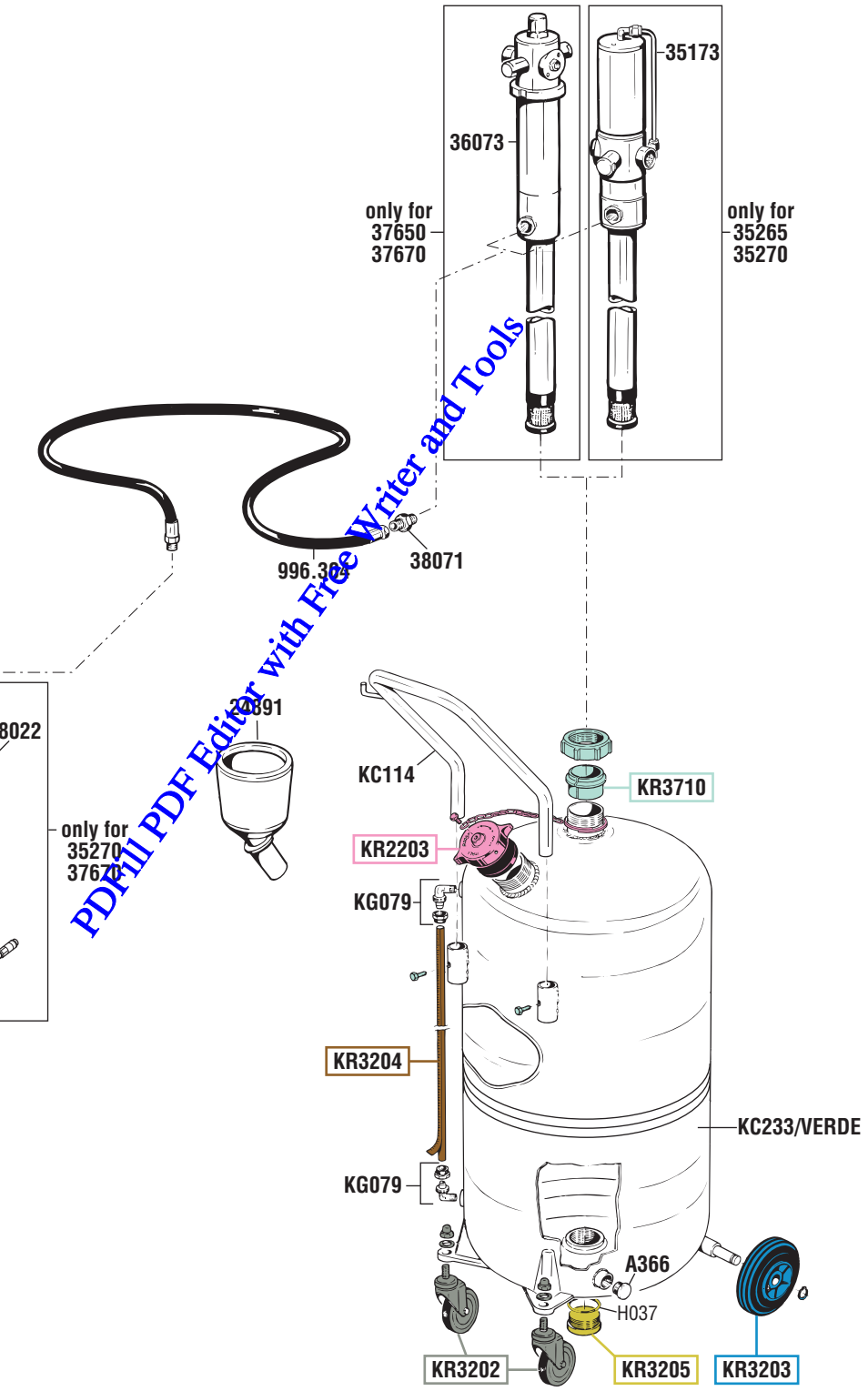

PDF-ILL PDF Editor with Free Writer and Tools

tutti i diritti riservati - all rights reserved



GUIDA RICAMBI - SPARE PARTS GUIDE

KIT RICAMBI

OGNI KIT SOTTO RIPORTATO COMPRENDE I RICAMBI EVIDENZIATI CON LO STESSO COLORE E LE RELATIVE GUARNIZIONI. QUESTI RICAMBI NON SONO FORNIBILI SEPARATAMENTE TRANNE QUELLI CODIFICATI.

SPARE PARTS KITS

EACH KIT SHOWN WITH THE SAME COLOR INCLUDES ALSO THE GASKETS. THE SPARE PARTS INCLUDED IN THE KIT CAN'T BE SUPPLIED SEPARATELY EXCEPT THOSE SHOWN WITH A PROPER CODE.

CODICE CODE	DESCRIZIONE DESCRIPTION	Q.TÀ QTY
KR2203	TAPPO ALTA PRESSIONE HIGH PRESSURE PLUG	1
KR3202	DUE RUOTE PIROETTANTI CON DADI TWO SWIVELLING WHEELS WITH NUTS	1
KR3203	2 RUOTE FISSE CON ANELLI ELASTICI 2 FIXED WHEELS WITH RETAINING RINGS	1
KR3204	TUBO DI LIVELLO ED ETICHETTA GAUGE TUBE AND LABEL	1
KR3205	TAPPO DI SCARICO DISCHARGING PLUG	1
KR3710	GHIERA IRON RING	1

ELENCO RICAMBI FORNIBILI SINGOLARMENTE

LIST OF SPARE PARTS WHICH CAN BE SUPPLIED SEPARATELY

CODICE CODE	DESCRIZIONE DESCRIPTION	Q.TÀ QTY
24891	IMBUTO FUNNEL	1
38071	NIPPLE M 1/2" G x M 1/2" G NIPPLE M 1/2" G x M 1/2" G	1
996.304	TUBO 1/2" - 4 m - 150 bar HOSE 1/2" - 4 m - 150 bar	1
A366	TAPPO PLUG	1
H037	O-RING 3137 O-RING 3137	1
KC114	MANICO A "U" HANDLE	1
KC233/VERDE	SERBATOIO 65 l RESERVOIR 65 l	1
KG079	GRUPPO GOMITO E GHIERA RING AND ELBOW JOINT GROUP	2

PER GLI ARTICOLI 35173, 36073, 38022, 37735 VEDERE RELATIVA SCHEDA RICAMBI

FOR THE ITEMS 35173, 36073, 38022, 37735 SEE THE RELATIVE REPLACEMENT PARTS CARD

PDFill PDF Editor with Free Writer and Tools

RAASM

FLUIDS AND LUBRICATION EQUIPMENT



Art. 36060 Mod. 5:1/60 - Art. 36061 Mod. 5:1/60 - Art. 36063 Mod. 5:1/1250
 Art. 36073 Mod. 5:1/73 - Art. 36076 Mod. 5:1/73 - Art. 36094 Mod. 5:1/94
 Art. 36096 Mod. 5:1/94



VISTA ESPLOSA - EXPLODED VIEW

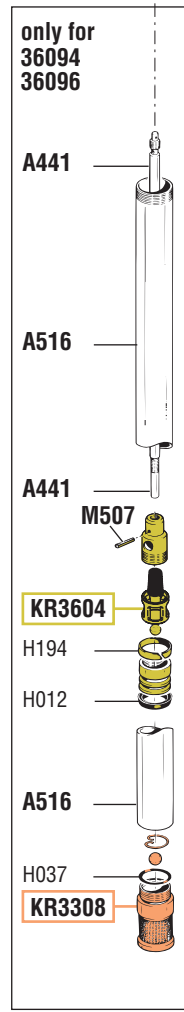
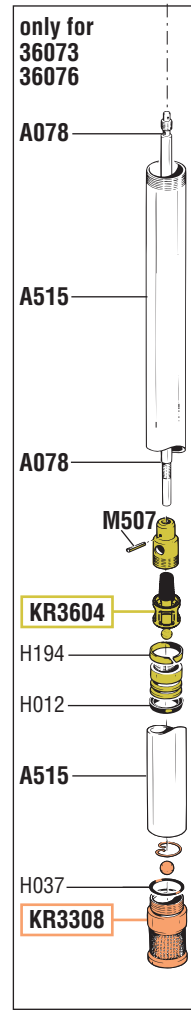
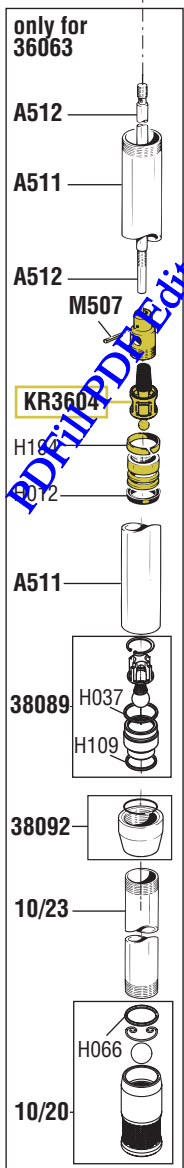
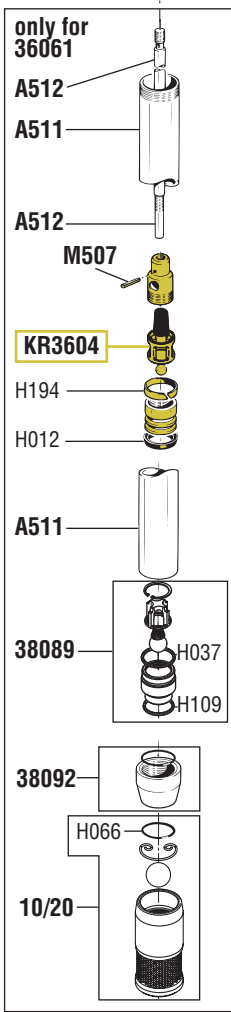
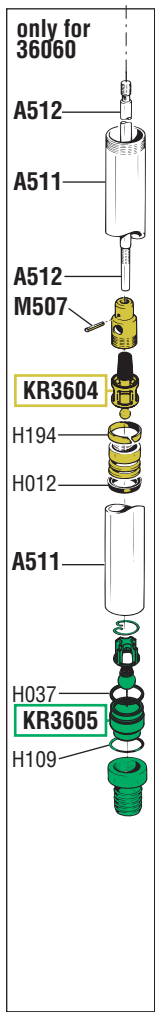
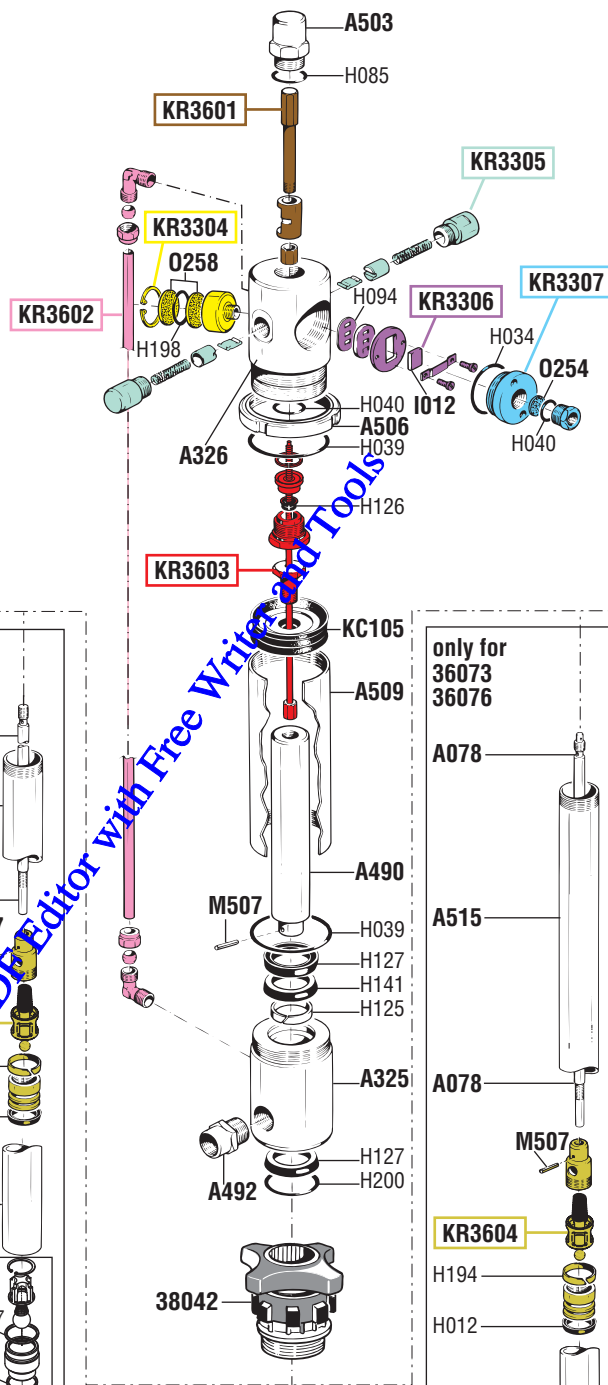
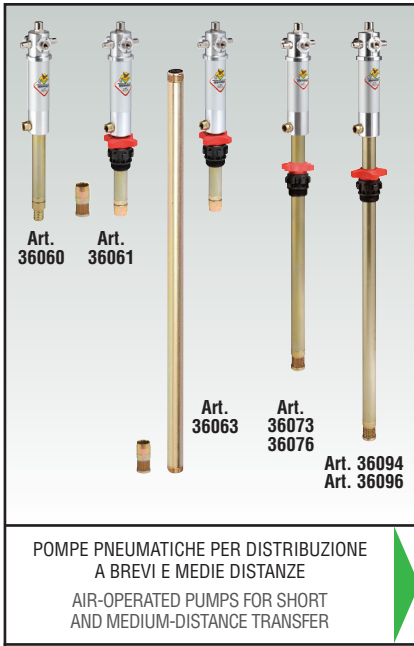

PDF Editor with Free Watermark

tutti i diritti riservati - all rights reserved

GUIDA RICAMBI - SPARE PARTS GUIDE

KIT RICAMBI OGNI KIT SOTTO RIPORTATO COMPRENDE I RICAMBI EVIDENZIATI CON LO STESSO COLORE E LE RELATIVE GUARNIZIONI. QUESTI RICAMBI NON SONO FORNIBILI SEPARATAMENTE TRANNE QUELLI CODIFICATI.		
SPARE PARTS KITS EACH KIT SHOWN WITH THE SAME COLOR INCLUDES ALSO THE GASKETS. THE SPARE PARTS INCLUDED IN THE KIT CAN'T BE SUPPLIED SEPARATELY EXCEPT THOSE SHOWN WITH A PROPER CODE.		
CODICE CODE	DESCRIZIONE DESCRIPTION	Q.TÀ QTY
KR3304	SILENZIATORE MUFFLER	1
KR3305	DOPPIO GRUPPO INVERTITORE DOUBLE PLUNGER GROUP	1
KR3306	GRUPPO DISTRIBUTORE D'ARIA SLIDE VALVE GROUP	1
KR3307	TAPPO ENTRATA ARIA AIR INLET CONNECTION	1
KR3308	FILTRO PESCANTE SHANK FILTER	1
KR3601	SPINGI INVERTITORE SHUTTLE GROUP	1
KR3602	TUBO RICICLO CON RACCORDI TUBE WITH CONNECTIONS	1
KR3603	STELO INVERTITORE ROD	1
KR3604	PISTONE POMPANTE OLIO OIL PUMPING PISTON	1
KR3605	VALVOLA FONDO PESCANTE (Art. 36060) BOTTOM VALVE (Art. 36060)	1

ELENCO RICAMBI FORNIBILI SINGOLARMENTE LIST OF SPARE PARTS WHICH CAN BE SUPPLIED SEPARATELY		
CODICE CODE	DESCRIZIONE DESCRIPTION	Q.TÀ QTY
38042	GHIERA DI BLOCCAGGIO ø 42 mm BUNG ADAPTOR ø 42 mm	1
38089	VALVOLA FONDO PESCANTE BOTTOM VALVE	1
38092	RACCORDO SUPERIORE F 1" UPPER CONNECTION F 1"	1
10/20	VALVOLA FONDO PESCANTE Art. 36061 - 36063 BOTTOM VALVE Art. 36061 - 36063	1
10/23	PROLUNGA PESCANTE 960 mm Art. 36063 SUCTION TUBE EXTENSION 960 mm Art. 36063	1
A078	STELO POMPANTE Art. 36073 PUMPING ROD Art. 36073	1
A325	CORPO INFERIORE MOTORE LOWER MOTOR BODY	1
A326	CORPO SUPERIORE MOTORE UPPER MOTOR BODY	1
A441	STELO POMPANTE Art. 36094 PUMPING ROD Art. 36094	1
A490	STELO MOTORE MOTOR ROD	1
A492	ADATTATORE M 1/2" G x F 1/2" G ADAPTOR M 1/2" G x F 1/2" G	1
A503	BOSSOLO GUIDA STELO INVERTITORE PLUNGER	1
A506	GHIERA DI BLOCCAGGIO RING NUT	1
A509	CILINDRO MOTORE MOTOR CYLINDER	1
A511	TUBO PESCANTE Art. 36060 - 36061 - 36063 SUCTION TUBE Art. 36060 - 36061 - 36063	1
A512	STELO POMPANTE PUMPING ROD	1
A515	TUBO PESCANTE Art. 36073 SUCTION TUBE Art. 36073	1
A516	TUBO PESCANTE Art. 36094 SUCTION TUBE Art. 36094	1
M507	SPINA ELASTICA ø 3 x 20 PIN ø 3 x 20	2

Art. KR3650	KIT GUARNIZIONI COMPLETO COMPOSTO DALLE GUARNIZIONI SOTTO ELENCAE JOINTS GASKETS LIST INCLUDING ALL THE GASKETS SHOWN HERE UNDER	
CODICE CODE	DESCRIZIONE DESCRIPTION	Q.TÀ QTY
H012	GUARNIZIONE GASKET	1
H034	O-RING 3156 O-RING 3156	1
H037	O-RING 3137 O-RING 3137	1
H039	O-RING 3225 O-RING 3225	2
H040	O-RING 123 O-RING 123	2
H066	O-RING 3118 O-RING 3118	1
H085	O-RING 2087 O-RING 2087	1
H094	GUARNIZIONI BASE DISTRIBUTORE GASKET	1
H109	O-RING 3131 O-RING 3131	1
H125	ANELLO GUIDA STELO GUIDE RING	1
H126	GUARNIZIONE ASTA INVERTITORE GASKET	1
H127	GUARNIZIONE GASKET	2
H141	GUARNIZIONE GASKET	1
H194	ANELLO GUIDA PISTONE POMPA PISTON GUIDE RING	1
H198	O-RING 3106 O-RING 3106	1
H200	O-RING 3162 O-RING 3162	1
I012	DISTRIBUTORE ARIA SLIDE VALVE	1
KC105	PISTONE PISTON	1
O254	SILENZIATORE A PASTICCA MUFFLER	1
O258	SILENZIATORE A PASTICCA MUFFLER	2

Art. KS3680	SET RICAMBI CONSIGLIATI AI PUNTI VENDITA E ASSISTENZA, COMPOSTO DAI RICAMBI SOTTO ELENCAE SPARE PARTS KIT ADVISED TO THE REPAIR CENTERS. THIS KIT INCLUDES ALL THE SPARE PARTS SHOWN HERE UNDER	
CODICE CODE	DESCRIZIONE DESCRIPTION	Q.TÀ QTY
A490	STELO MOTORE MOTOR ROD	1
KR3305	DOPPIO GRUPPO INVERTITORE DOUBLE PLUNGER GROUP	1
KR3306	GRUPPO DISTRIBUTORE D'ARIA SLIDE VALVE GROUP	1
KR3650	KIT GUARNIZIONI COMPLETO COMPLETE GASKETS KIT	1
M507	SPINA ELASTICA ø 3 x 20 PIN ø 3 x 20	2



Art. 36601 - Art. 36602 - Art. 36603 - Art. 36604 - Art. 36641



VISTA ESPLOSA - EXPLODED VIEW

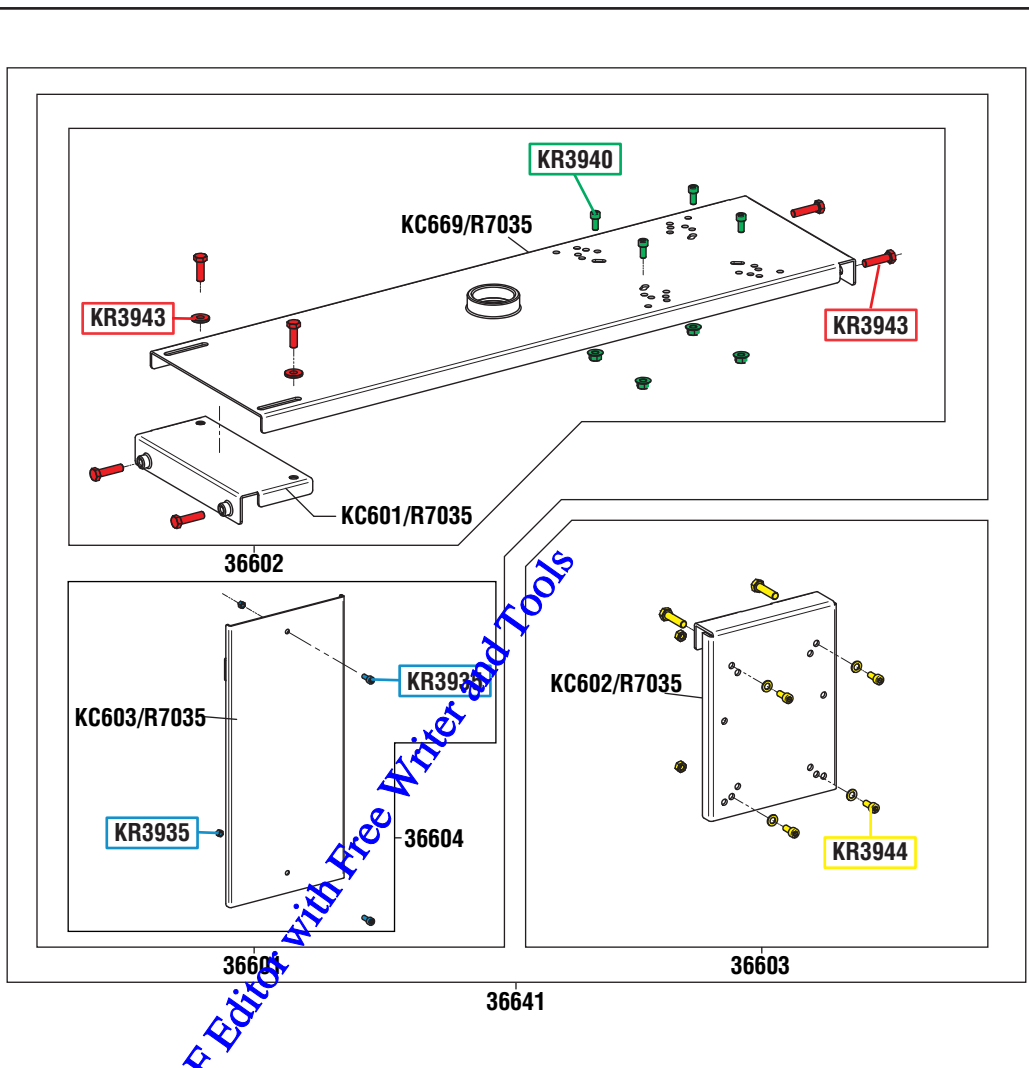

tutti i diritti riservati - all rights reserved

GUIDA RICAMBI - SPARE PARTS GUIDE

KIT RICAMBI
OGNI KIT SOTTO RIPORTATO COMPRENDE I RICAMBI EVIDENZIATI CON LO STESSO COLORE E LE RELATIVE GUARNIZIONI. QUESTI RICAMBI NON SONO FORNIBILI SEPARATAMENTE TRAMIE QUELLI CODIFICATI.

SPARE PARTS KITS
EACH KIT SHOWN WITH THE SAME COLOR INCLUDES ALSO THE GASKETS. THE SPARE PARTS INCLUDED IN THE KIT CAN'T BE SUPPLIED SEPARATELY EXCEPT THOSE SHOWN WITH A PROPER CODE.

CODICE CODE	DESCRIZIONE DESCRIPTION	Q.TÀ QTY
KR3935	VITERIA FISSAGGIO RACCOGLIGOCCE SCREWS FOR DRIP-TRAY FIXING	1
KR3940	VITERIA FISSAGGIO AVVOLGITUBO SCREWS FOR HOSE REEL FIXING	1
KR3943	VITERIA FISSAGGIO STAFFE SCREWS FOR BRACKETS FIXING	1
KR3944	VITERIA FISSAGGIO POMPA SCREWS FOR PUMP FIXING	1

ELENCO RICAMBI FORNIBILI SINGOLARMENTE
LIST OF SPARE PARTS WHICH CAN BE SUPPLIED SEPARATELY

CODICE CODE	DESCRIZIONE DESCRIPTION	Q.TÀ QTY
KC601/R7035	STAFFA DI REGOLAZIONE PER Art. 36601-36602-36641 REGULATION BRACKET FOR Art. 36601-36602-36641	1
KC602/R7035	STAFFA PORTA POMPA PER Art. 36603 - 36641 BRACKET FOR PUMP FIXING FOR Art. 36603 - 36641	1
KC603/R7035	STAFFA PER SALVAGOCCE PER Art. 36601 - 36604 - 36641 BRACKET FOR DRIP-TRAY FIXING FOR Art. 36601 - 36604 - 36641	1
KC669/R7035	STAFFA PORTA AVVOLGITUBO PER Art. 36601-36602-36641 BRACKET FOR HOSE REEL FIXING FOR Art. 36601-36602-36641	1



Art. 37681 - Art. 37683



VISTA ESPLOSA - EXPLODED VIEW



RUBINETTO CON TUBO PER BAR OLIO A POMPA
TAP FOR OIL BAR WITH CONNECTION TO PUMP

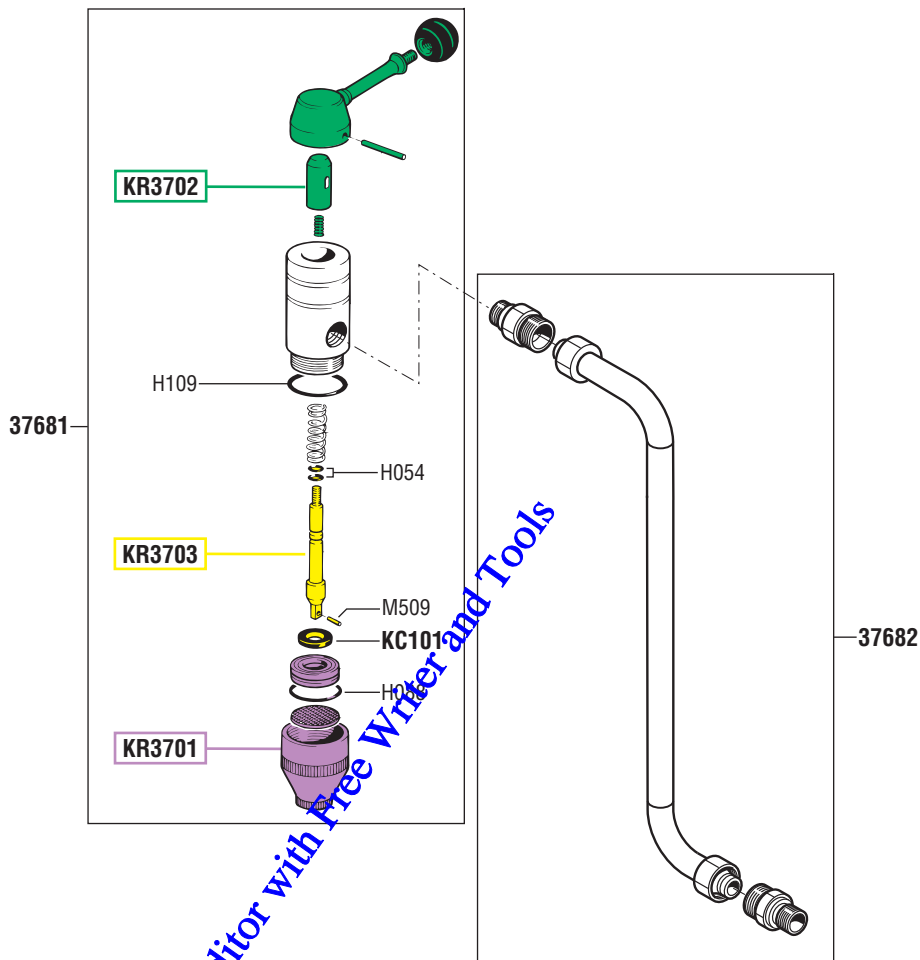

GUIDA RICAMBI - SPARE PARTS GUIDE

KIT RICAMBI
OGNI KIT SOTTO RIPORTATO COMPRENDE I RICAMBI EVIDENZIATI CON LO STESSO COLORE E LE RELATIVE GUARNIZIONI. QUESTI RICAMBI NON SONO FORNIBILI SEPARATAMENTE TRANNE QUELLI CODIFICATI.

SPARE PARTS KITS
EACH KIT SHOWN WITH THE SAME COLOR INCLUDES ALSO THE GASKETS. THE SPARE PARTS INCLUDED IN THE KIT CAN'T BE SUPPLIED SEPARATELY EXCEPT THOSE SHOWN WITH A PROPER CODE.

CODICE CODE	DESCRIZIONE DESCRIPTION	Q.TÀ QTY
KR3701	TERMINALE TERMINAL	1
KR3702	COMANDO RUBINETTO TAP CONTROL	1
KR3703	VALVOLA COMANDO RUBINETTO TAP CONTROL VALVE	1

ELENCO RICAMBI FORNIBILI SINGOLARMENTE
LIST OF SPARE PARTS WHICH CAN BE SUPPLIED SEPARATELY

CODICE CODE	DESCRIZIONE DESCRIPTION	Q.TÀ QTY
37681	RUBINETTO BAR OLIO OIL BAR TAP	1
37682	TUBO DI COLLEGAMENTO CONNECTION HOSE	1

Art. KR3750
KIT GUARNIZIONI COMPLETO
COMPOSTO DALLE GUARNIZIONI SOTTO ELENCAE
JOINTS GASKETS LIST
INCLUDING ALL THE GASKETS SHOWN HERE UNDER

CODICE CODE	DESCRIZIONE DESCRIPTION	Q.TÀ QTY
H054	O-RING 2018 O-RING 2018	2
H088	O-RING 2106 "NBR 70" O-RING 2106 "NBR 70"	1
H109	O-RING 3131 O-RING 3131	1
KC101	VALVOLA VALVE	1
M509	SPINA ELASTICA ø 3 x 10 PIN ø 3 x 10	1

SET RICAMBI CONSIGLIATI
AI PUNTI VENDITA E ASSISTENZA.
COMPOSTO DAI RICAMBI SOTTO ELENCAE
SPARE PARTS KIT ADVISED
TO THE REPAIR CENTERS. THIS KIT INCLUDES
ALL THE SPARE PARTS SHOWN HERE UNDER

CODICE CODE	DESCRIZIONE DESCRIPTION	Q.TÀ QTY
KR3750	KIT GUARNIZIONI COMPLETO COMPLETE GASKETS KIT	1

tutti i diritti riservati - all rights reserved



Art. 37686 Mod. B.O. - Art. 37687 Mod. B.O. - Art. 37691 Mod. B.O.



VISTA ESPLOSA - EXPLODED VIEW

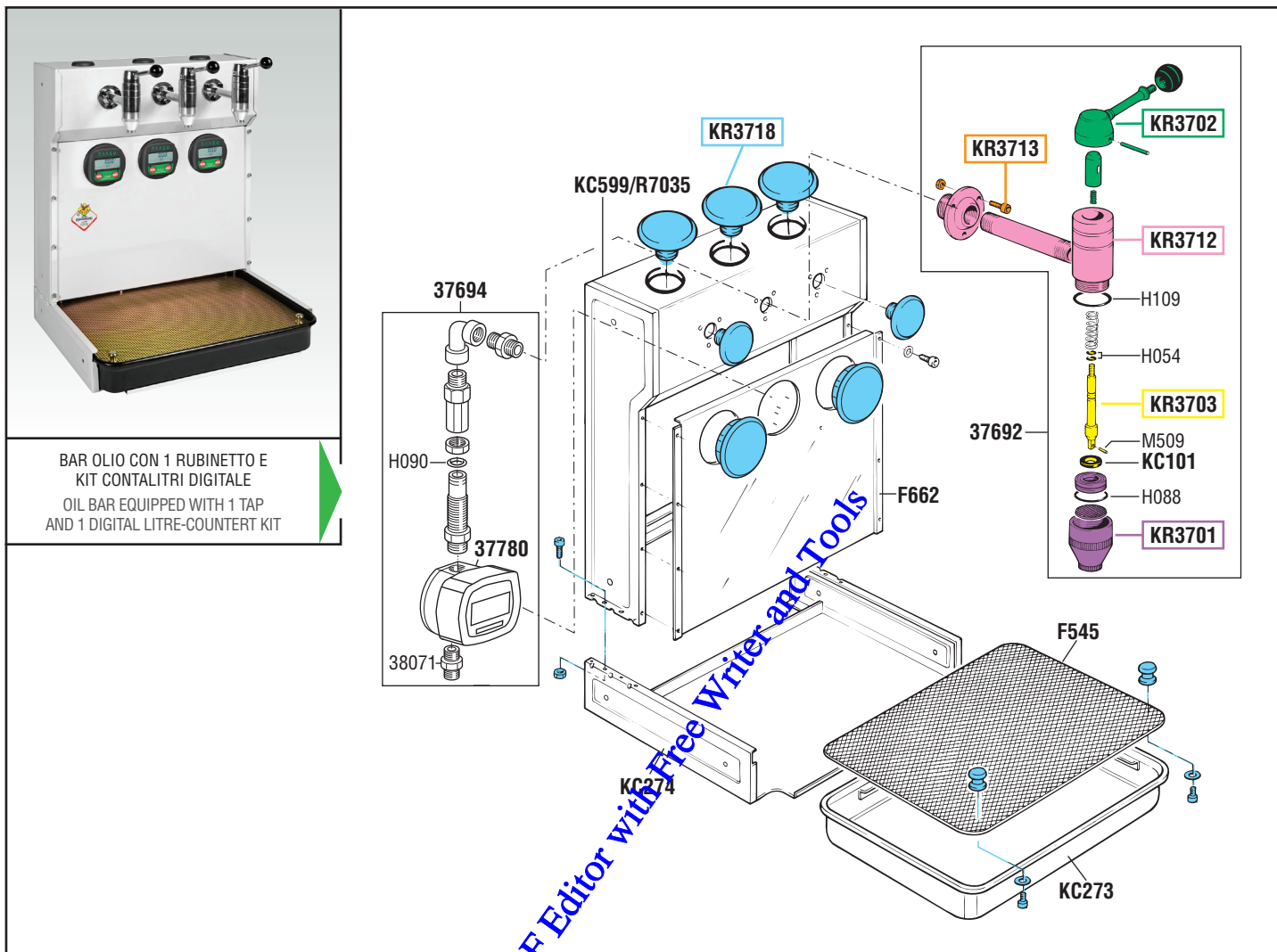

BAR OLIO CON 1 RUBINETTO E KIT CONTALITRI DIGITALE
OIL BAR EQUIPPED WITH 1 TAP AND 1 DIGITAL LITRE-COUNTERT KIT

PDF Editor with Free Writer and Tools

tutti i diritti riservati - all rights reserved

GUIDA RICAMBI - SPARE PARTS GUIDE

KIT RICAMBI
OGNI KIT SOTTO RIPORTATO COMPRENDE I RICAMBI EVIDENZIATI CON LO STESSO COLORE E LE RELATIVE GUARNIZIONI. QUESTI RICAMBI NON SONO FORNIBILI SEPARATAMENTE TRANNE QUELLI CODIFICATI.

SPARE PARTS KITS
EACH KIT SHOWN WITH THE SAME COLOR INCLUDES ALSO THE GASKETS. THE SPARE PARTS INCLUDED IN THE KIT CAN'T BE SUPPLIED SEPARATELY EXCEPT THOSE SHOWN WITH A PROPER CODE.

CODICE CODE	DESCRIZIONE DESCRIPTION	Q.TÀ QTY
KR3701	TERMINALE TERMINAL	1
KR3702	COMANDO RUBINETTO TAP CONTROL	1
KR3703	VALVOLA COMANDO RUBINETTO TAP CONTROL VALVE	1
KR3712	CORPO RUBINETTO TAP BODY	1
KR3713	VITI SCREWS	1
KR3718	ACCESSORI BAR OLIO OIL BAR ACCESSORIES	1

ELENCO RICAMBI FORNIBILI SINGOLARMENTE
LIST OF SPARE PARTS WHICH CAN BE SUPPLIED SEPARATELY

CODICE CODE	DESCRIZIONE DESCRIPTION	Q.TÀ QTY
37692	RUBINETTO BAR OLIO OIL BAR TAP	1
37694	GRUPPO CONTALITRI DIGITAL OIL METER KIT	1
37780	CONTALITRI DIGITALE DIGITAL OIL METER	1
38071	NIPPLE M 1/2" G x M 1/2" G NIPPLE M 1/2" G x M 1/2" G	1
F545	GRIGLIA VASCHETTA BAR OLIO OIL BAR NET	1
F662	PARETE ANTERIORE BAR OLIO OIL BAR FRONT SIDE	1
H090	O-RING 3056 O-RING 3056	1
KC273	VASCHETTA BAR OLIO OIL BAR BASIN	1
KC274	FONDO BAR OLIO OIL BAR BOTTOM	1
KC599/R7035	CORPO BAR OLIO OIL BAR BODY	1

Art. KR3750 KIT GUARNIZIONI COMPLETO
COMPOSTO DALLE GUARNIZIONI SOTTO ELENCAE JOINTS GASKETS LIST INCLUDING ALL THE GASKETS SHOWN HERE UNDER

CODICE CODE	DESCRIZIONE DESCRIPTION	Q.TÀ QTY
H054	O-RING 2018 O-RING 2018	2
H088	O-RING 2106 "NBR 70" O-RING 2106 "NBR 70"	1
H109	O-RING 3131 O-RING 3131	1
KC101	VALVOLA VALVE	1
M509	SPINA ELASTICA ø 3 x 10 PIN ø 3 x 10	1

SET RICAMBI CONSIGLIATI
AI PUNTI VENDITA E ASSISTENZA. COMPOSTO DAI RICAMBI SOTTO ELENCAE
SPARE PARTS KIT ADVISED TO THE REPAIR CENTERS. THIS KIT INCLUDES ALL THE SPARE PARTS SHOWN HERE UNDER

CODICE CODE	DESCRIZIONE DESCRIPTION	Q.TÀ QTY
KR3750	KIT GUARNIZIONI COMPLETO COMPLETE GASKETS KIT	1



Art. 37688 Mod. B.O. - Art. 37689 Mod. B.O. - Art. 37690 Mod. B.O.



VISTA ESPLOSA - EXPLODED VIEW

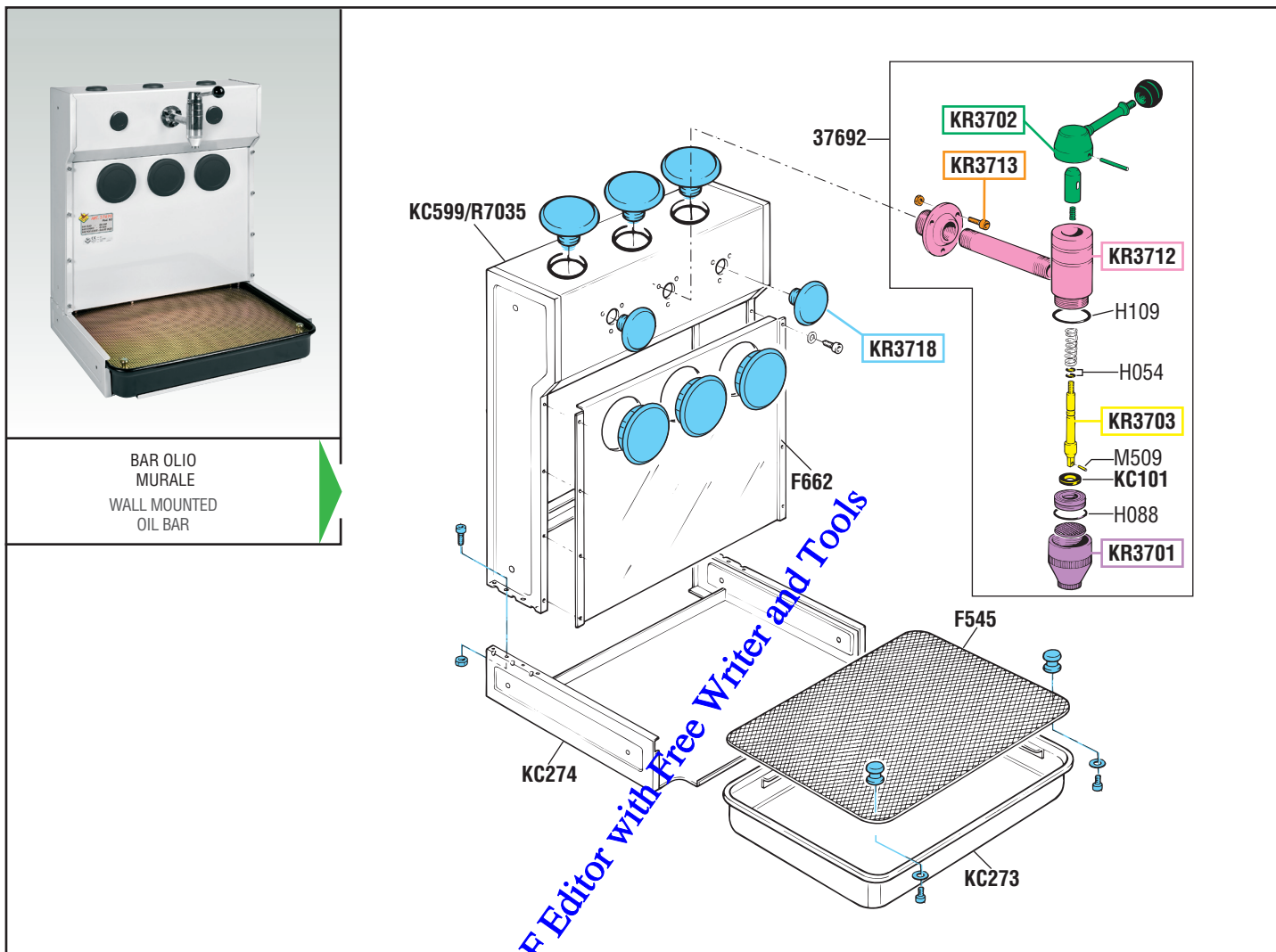

BAR OLIO
MURALE
WALL MOUNTED
OIL BAR

GUIDA RICAMBI - SPARE PARTS GUIDE

KIT RICAMBI

OGNI KIT SOTTO RIPORTATO COMPRENDE I RICAMBI EVIDENZIATI CON LO STESSO COLORE E LE RELATIVE GUARNIZIONI. QUESTI RICAMBI NON SONO FORNIBILI SEPARATAMENTE TRANNE QUELLI CODIFICATI.

SPARE PARTS KITS

EACH KIT SHOWN WITH THE SAME COLOR INCLUDES ALSO THE GASKETS. THE SPARE PARTS INCLUDED IN THE KIT CAN'T BE SUPPLIED SEPARATELY EXCEPT THOSE SHOWN WITH A PROPER CODE.

CODICE CODE	DESCRIZIONE DESCRIPTION	Q.TÀ QTY
KR3701	TERMINALE TERMINAL	1
KR3702	COMANDO RUBINETTO TAP CONTROL	1
KR3703	VALVOLA COMANDO RUBINETTO TAP CONTROL VALVE	1
KR3712	CORPO RUBINETTO TAP BODY	1
KR3713	VITI SCREWS	1
KR3718	ACCESSORI BAR OLIO OIL BAR ACCESSORIES	1

ELENCO RICAMBI FORNIBILI SINGOLARMENTE

LIST OF SPARE PARTS WHICH CAN BE SUPPLIED SEPARATELY

CODICE CODE	DESCRIZIONE DESCRIPTION	Q.TÀ QTY
37692	RUBINETTO BAR OLIO OIL BAR TAP	1
F545	GRIGLIA VASCHETTA BAR OLIO OIL BAR NET	1
F662	PARETE ANTERIORE BAR OLIO OIL BAR FRONT SIDE	1
KC273	VASCHETTA BAR OLIO OIL BAR BASIN	1
KC274	FONDO BAR OLIO OIL BAR BOTTOM	1
KC599/R7035	CORPO BAR OLIO OIL BAR BODY	1

Art.
KR3750

KIT GUARNIZIONI COMPLETO

COMPOSTO DALLE GUARNIZIONI SOTTO ELENCATE
JOINTS GASKETS LIST
INCLUDING ALL THE GASKETS SHOWN HERE UNDER

CODICE CODE	DESCRIZIONE DESCRIPTION	Q.TÀ QTY
H054	O-RING 2018 O-RING 2018	2
H088	O-RING 2106 "NBR 70" O-RING 2106 "NBR 70"	1
H109	O-RING 3131 O-RING 3131	1
KC101	VALVOLA VALVE	1
M509	SPINA ELASTICA ø 3 x 10 PIN ø 3 x 10	1

SET RICAMBI CONSIGLIATI

AI PUNTI VENDITA E ASSISTENZA
COMPOSTO DAI RICAMBI SOTTO ELENCA TI

SPARE PARTS KIT ADVISED
TO THE REPAIR CENTERS. THIS KIT INCLUDES
ALL THE SPARE PARTS SHOWN HERE UNDER

CODICE CODE	DESCRIZIONE DESCRIPTION	Q.TÀ QTY
KR3750	KIT GUARNIZIONI COMPLETO COMPLETE GASKETS KIT	1

tutti i diritti riservati - all rights reserved



Art. 37692



VISTA ESPLOSA - EXPLODED VIEW



RUBINETTO A DOPPIA VALVOLA
CON FILTRO FRANGIFLUTTI
DOUBLE VALVE TAP
WITH ANTISPLASH FILTER

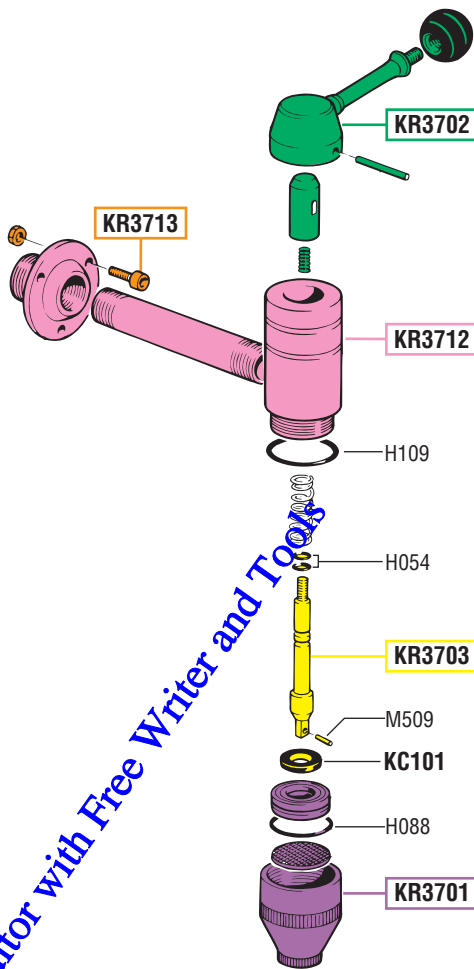

GUIDA RICAMBI - SPARE PARTS GUIDE

KIT RICAMBI

OGNI KIT SOTTO RIPORTATO COMPRENDE I RICAMBI EVIDENZIATI CON LO STESSO COLORE E LE RELATIVE GUARNIZIONI. QUESTI RICAMBI NON SONO FORNIBILI SEPARATAMENTE TRANNE QUELLI CODIFICATI.

SPARE PARTS KITS

EACH KIT SHOWN WITH THE SAME COLOR INCLUDES ALSO THE GASKETS. THE SPARE PARTS INCLUDED IN THE KIT CAN'T BE SUPPLIED SEPARATELY EXCEPT THOSE SHOWN WITH A PROPER CODE.

CODICE CODE	DESCRIZIONE DESCRIPTION	Q.TÀ QTY
KR3701	TERMINALE TERMINAL	1
KR3702	COMANDO RUBINETTO TAP CONTROL	1
KR3703	VALVOLA COMANDO RUBINETTO TAP CONTROL VALVE	1
KR3712	CORPO RUBINETTO TAP BODY	1
KR3713	VITI SCREWS	1

ELENCO RICAMBI FORNIBILI SINGOLARMENTE

LIST OF SPARE PARTS WHICH CAN BE SUPPLIED SEPARATELY

CODICE CODE	DESCRIZIONE DESCRIPTION	Q.TÀ QTY
H054	O-RING 2018 O-RING 2018	2
H088	O-RING 2106 "NBR 70" O-RING 2106 "NBR 70"	1
H109	O-RING 3131 O-RING 3131	1
KC101	VALVOLA VALVE	1
M509	SPINA ELASTICA ø 3 x 10 PIN ø 3 x 10	1

SET RICAMBI CONSIGLIATI

AI PUNTI VENDITA E ASSISTENZA,
COMPOSTO DAI RICAMBI SOTTO ELENCATI

SPARE PARTS KIT ADVISED
TO THE REPAIR CENTERS. THIS KIT INCLUDES
ALL THE SPARE PARTS SHOWN HERE UNDER

CODICE CODE	DESCRIZIONE DESCRIPTION	Q.TÀ QTY
KR3750	KIT GUARNIZIONI COMPLETO COMPLETE GASKETS KIT	1

tutti i diritti riservati - all rights reserved



Art. 37697 - Art. 37698



VISTA ESPLOSA - EXPLODED VIEW

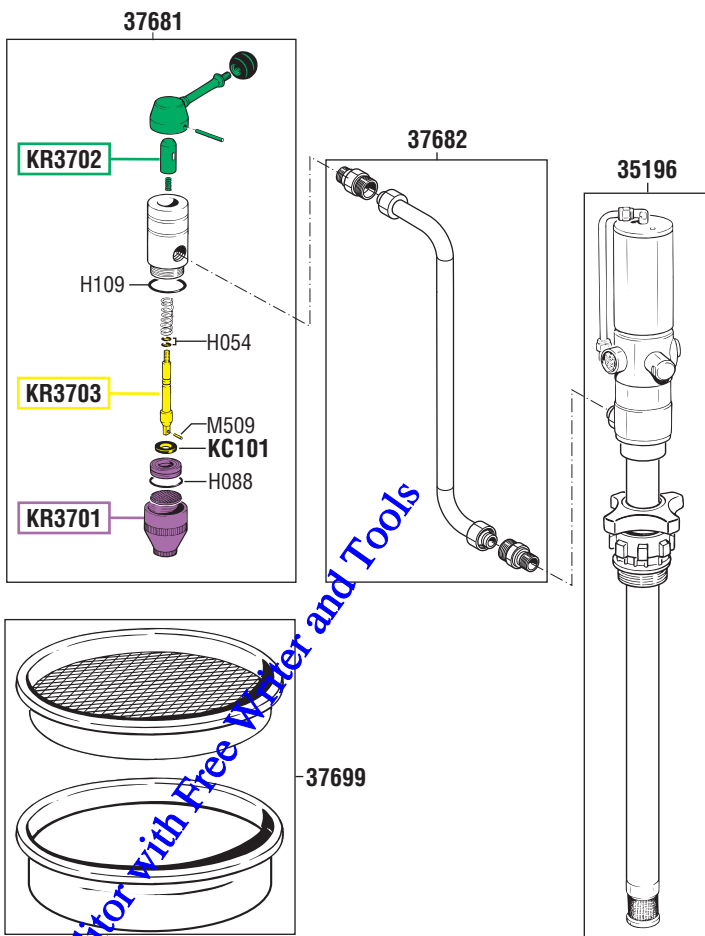

GUIDA RICAMBI - SPARE PARTS GUIDE

KIT RICAMBI
OGNI KIT SOTTO RIPORTATO COMPRENDE I RICAMBI EVIDENZIATI CON LO STESSO COLORE E LE RELATIVE GUARNIZIONI. QUESTI RICAMBI NON SONO FORNIBILI SEPARATAMENTE TRANNE QUELLI CODIFICATI.

SPARE PARTS KITS
EACH KIT SHOWN WITH THE SAME COLOR INCLUDES ALSO THE GASKETS. THE SPARE PARTS INCLUDED IN THE KIT CAN'T BE SUPPLIED SEPARATELY EXCEPT THOSE SHOWN WITH A PROPER CODE.

CODICE CODE	DESCRIZIONE DESCRIPTION	Q.TÀ QTY
KR3701	TERMINALE TERMINAL	1
KR3702	COMANDO RUBINETTO TAP CONTROL	1
KR3703	VALVOLA COMANDO RUBINETTO TAP CONTROL VALVE	1

ELENCO RICAMBI FORNIBILI SINGOLARMENTE
LIST OF SPARE PARTS WHICH CAN BE SUPPLIED SEPARATELY

CODICE CODE	DESCRIZIONE DESCRIPTION	Q.TÀ QTY
35196	POMPA PER DISTRIBUZIONE R 3:1 DISTRIBUTION PUMP R 3:1	1
37681	RUBINETTO BAR OLIO OIL BAR TAP	1
37682	TUBO DI COLLEGAMENTO CONNECTION HOSE	1
37699	VASCHETTA RACCOGLIGOCCE DRIP-CATCHER TRAY	1

Art. KR3750
KIT GUARNIZIONI COMPLETO
COMPOSTO DALLE GUARNIZIONI SOTTO ELENCAE
JOINTS GASKETS LIST
INCLUDING ALL THE GASKETS SHOWN HERE UNDER

CODICE CODE	DESCRIZIONE DESCRIPTION	Q.TÀ QTY
H054	O-RING 2018 O-RING 2018	2
H088	O-RING 2106 "NBR 70" O-RING 2106 "NBR 70"	1
H109	O-RING 3131 O-RING 3131	1
KC101	VALVOLA VALVE	1
M509	SPINA ELASTICA ø 3 x 10 PIN ø 3 x 10	1

PER I KIT RICAMBI DELL' Art. 35196 VEDERE I RELATIVI ESPLOSI
FOR THE SPARE PARTS KITS OF Art. 35196 PLEASE REFER TO PERTINENT EXPLODED VIEWS

SET RICAMBI CONSIGLIATI
AI PUNTI VENDITA E ASSISTENZA.
COMPOSTO DAI RICAMBI SOTTO ELENCAE
SPARE PARTS KIT ADVISED
TO THE REPAIR CENTERS. THIS KIT INCLUDES
ALL THE SPARE PARTS SHOWN HERE UNDER

CODICE CODE	DESCRIZIONE DESCRIPTION	Q.TÀ QTY
KR3750	KIT GUARNIZIONI COMPLETO COMPLETE GASKETS KIT	1

tutti i diritti riservati - all rights reserved



Art. 37728 - Art. 37729 - Art. 37730

VISTA ESPLOSA - EXPLODED VIEW

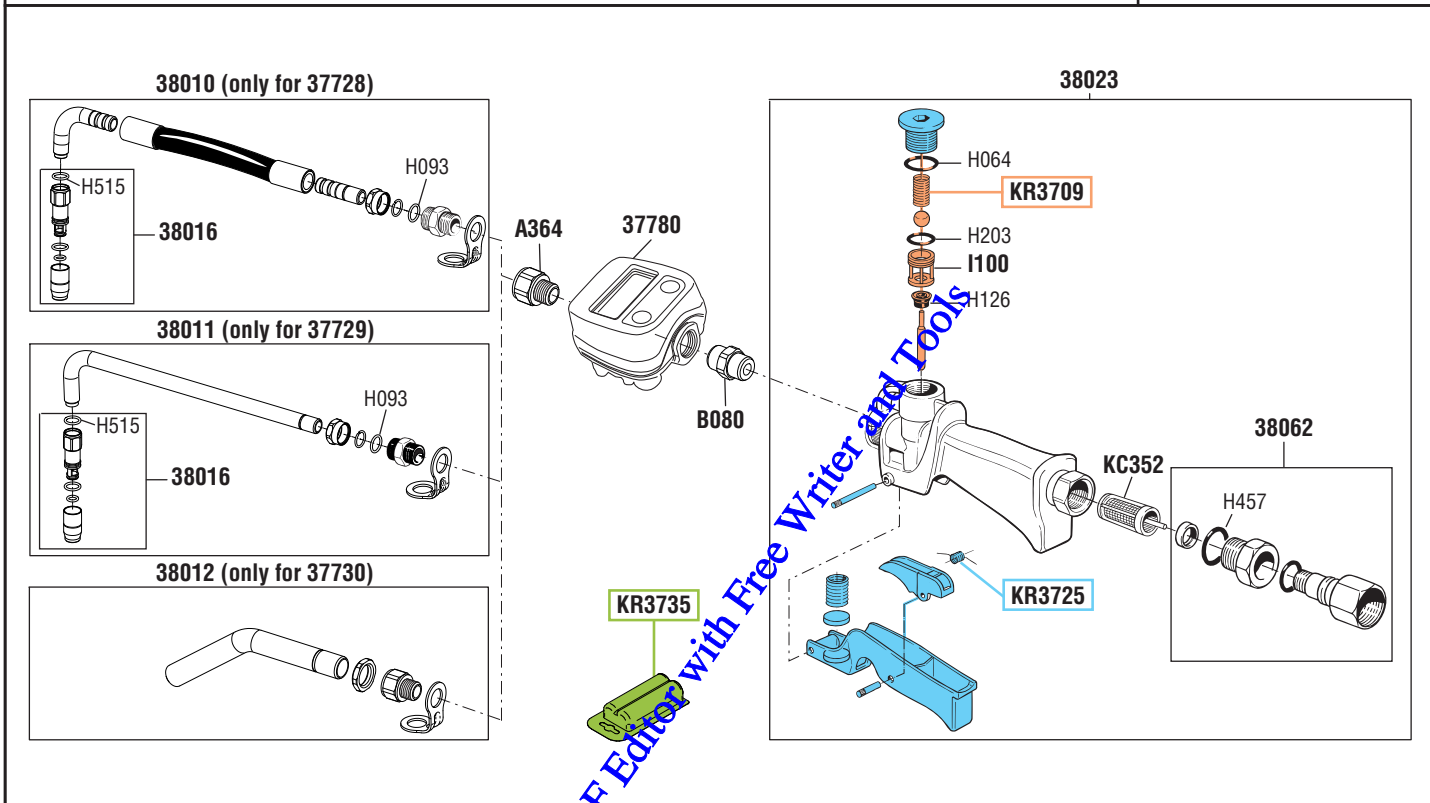
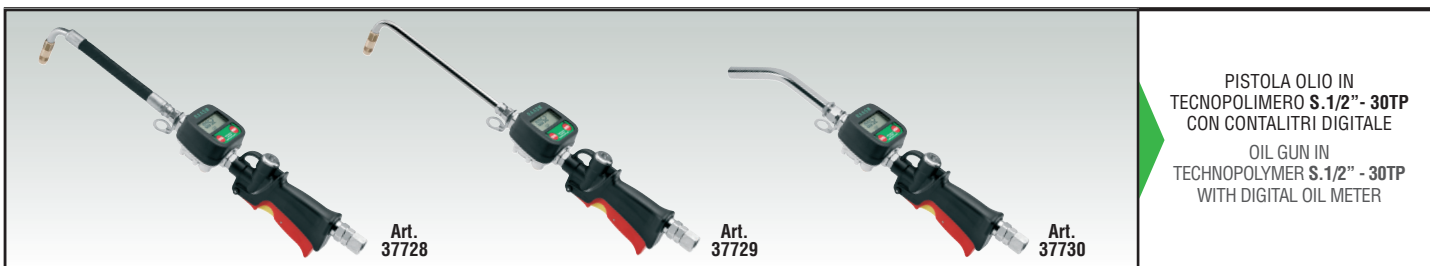

tutti i diritti riservati - all rights reserved

GUIDA RICAMBI - SPARE PARTS GUIDE

KIT RICAMBI
OGNI KIT SOTTO RIPORTATO COMPRENDE I RICAMBI EVIDENZIATI CON LO STESSO COLORE E LE RELATIVE GUARNIZIONI. QUESTI RICAMBI NON SONO FORNIBILI SEPARATAMENTE TRANNE QUELLI CODIFICATI.

SPARE PARTS KITS
EACH KIT SHOWN WITH THE SAME COLOR INCLUDES ALSO THE GASKETS. THE SPARE PARTS INCLUDED IN THE KIT CAN'T BE SUPPLIED SEPARATELY EXCEPT THOSE SHOWN WITH A PROPER CODE.

CODICE CODE	DESCRIZIONE DESCRIPTION	Q.TÀ QTY
KR3709	VALVOLA PISTOLA 3/8" OIL GUN VALVE 3/8"	1
KR3725	LEVA E PULSANTE PISTOLA OLIO OIL GUN LEVER AND LOCKING BUTTON	1
KR3735	KIT 2 BATTERIE MINISTILO "AAA" 1.5V AAA 1.5 V PENLIGHT BATTERY KITS	1

ELENCO RICAMBI FORNIBILI SINGOLARMENTE
LIST OF SPARE PARTS WHICH CAN BE SUPPLIED SEPARATELY

CODICE CODE	DESCRIZIONE DESCRIPTION	Q.TÀ QTY
A364	RIDUZIONE M 1/2" G - F 3/8" G ADAPTOR M1/2" G - F 3/8" G	1
B080	NIPPLE M 3/8" - M 1/2" NIPPLE M 3/8" - M 1/2"	1
37780	CONTALITRI DIGITALE "RAASM" DIGITAL OIL METER "RAASM"	1
38016	UGELLO SALVAGOCCE SEMIAUTOMATICO SEMIAUTOMATIC DRIP-CATCHER NOZZLE	1
38010	TERMINALE FLESSIBILE (Art. 37728) FLEXIBLE TERMINAL (Art. 37728)	1
38011	TERMINALE RIGIDO (Art. 37729) RIGID TERMINAL (Art. 37729)	1
38012	TERMINALE ALTA PORTATA (Art. 37730) HIGH DELIVERY RIGID TERMINAL (Art. 37730)	1
38023	IMPUGNATURA TECNOPOLIMERO GRIP IN TECNOPOLYMER	1
38062	SNODO GIREVOLE SWIVEL JOINT	1
KC352	FILTRO PISTOLA 3/8" FILTER GUN 3/8"	1

Art. KR3752
KIT GUARNIZIONI COMPLETO
COMPOSTO DALLE GUARNIZIONI SOTTO ELENCAE
JOINTS GASKETS LIST
INCLUDING ALL THE GASKETS SHOWN HERE UNDER

CODICE CODE	DESCRIZIONE DESCRIPTION	Q.TÀ QTY
H064	O-RING 3043 O-RING 3043	1
H093	O-RING 2050 "VITON" O-RING 2050 "VITON"	1
H126	GUARNIZIONE ASTA INVERTITORE GASKET	1
H203	O-RING 2050 "90SH" O-RING 2050 "90SH"	1
H457	O-RING 123 "VITON" O-RING 123 "VITON"	1
H515	O-RING 2043 "VITON" O-RING 2043 "VITON"	1
I100	CASTELLETTO MOUNT	1
KC352	FILTRO PISTOLA 3/8" FILTER GUN 3/8"	1

Art. KS3782
SET RICAMBI CONSIGLIATI
AI PUNTI VENDITA E ASSISTENZA,
COMPOSTO DAI RICAMBI SOTTO ELENCAE
SPARE PARTS KIT ADVISED
TO THE REPAIR CENTERS. THIS KIT INCLUDES
ALL THE SPARE PARTS SHOWN HERE UNDER

CODICE CODE	DESCRIZIONE DESCRIPTION	Q.TÀ QTY
KR3709	VALVOLA PISTOLA OIL GUN VALVE	1
KR3752	KIT GUARNIZIONI COMPLETO COMPLETE GASKETS KIT	1



Art. 37740 - Art. 37741 - Art. 37742 - Art. 37743

VISTA ESPLOSA - EXPLODED VIEW

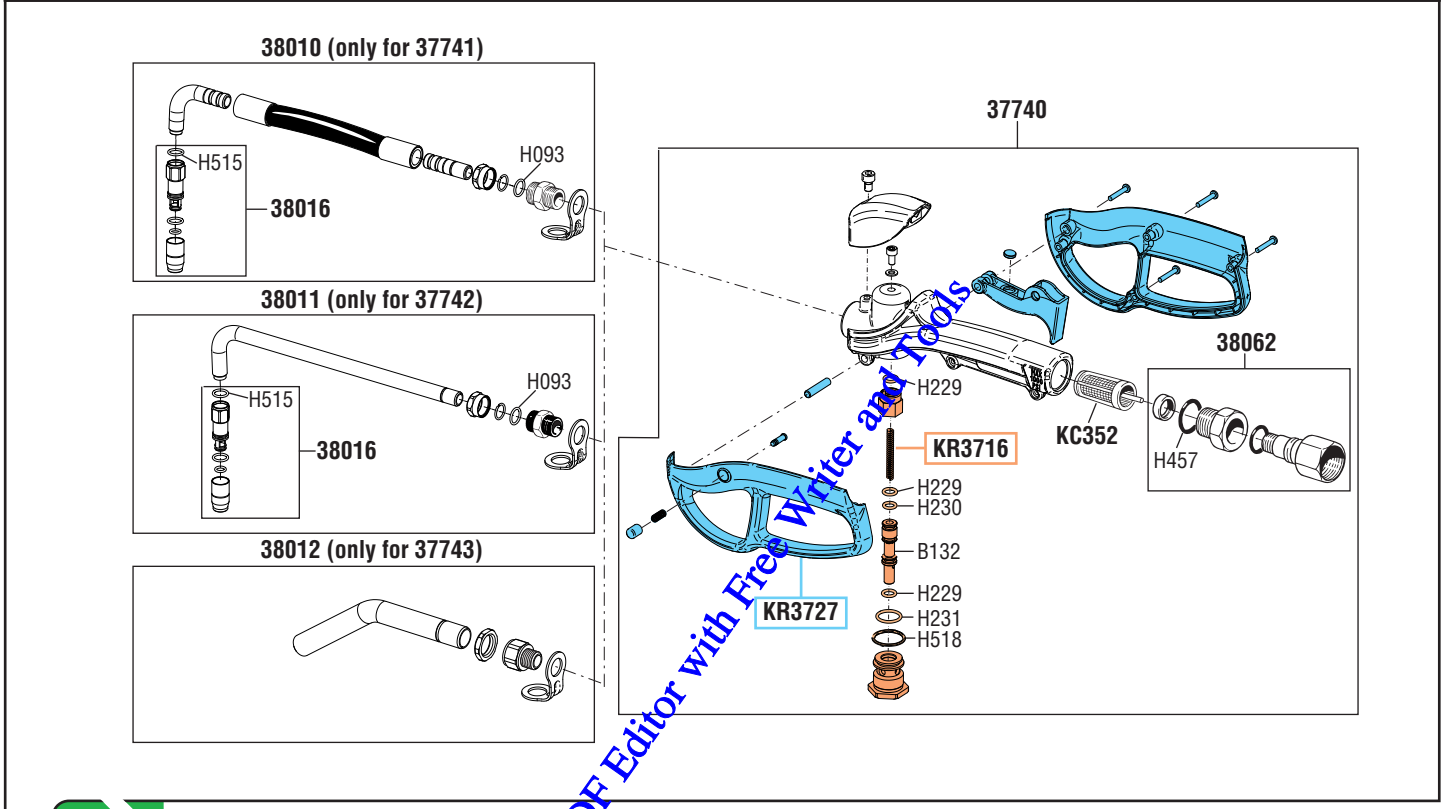
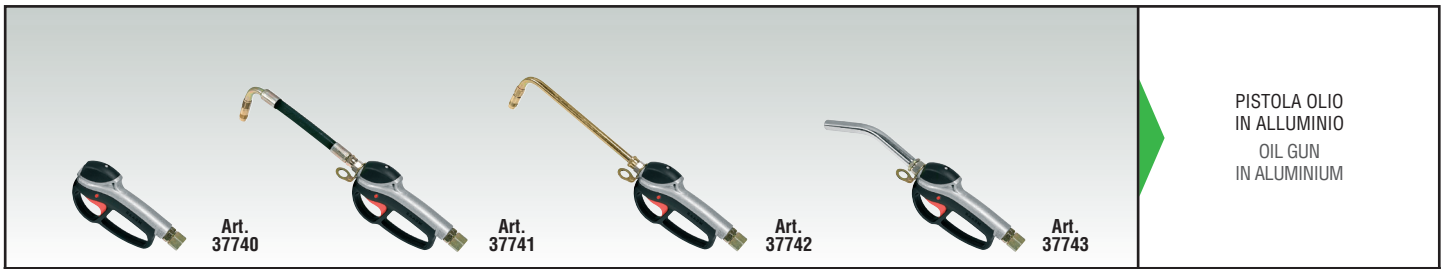

tutti i diritti riservati - all rights reserved

GUIDA RICAMBI - SPARE PARTS GUIDE

KIT RICAMBI
OGNI KIT SOTTO RIPORTATO COMPRENDE I RICAMBI EVIDENZIATI CON LO STESSO COLORE E LE RELATIVE GUARNIZIONI. QUESTI RICAMBI NON SONO FORNIBILI SEPARATAMENTE TRANNE QUELLI CODIFICATI.

SPARE PARTS KITS
EACH KIT SHOWN WITH THE SAME COLOR INCLUDES ALSO THE GASKETS. THE SPARE PARTS INCLUDED IN THE KIT CAN'T BE SUPPLIED SEPARATELY EXCEPT THOSE SHOWN WITH A PROPER CODE.

CODICE CODE	DESCRIZIONE DESCRIPTION	Q. TÀ QTY
KR3716	VALVOLA PISTOLA 3/8" OIL GUN VALVE 3/8"	1
KR3727	LEVA E PULSANTE PISTOLA OLIO OIL GUN LEVER AND LOCKING BUTTON	1

ELENCO RICAMBI FORNIBILI SINGOLARMENTE
LIST OF SPARE PARTS WHICH CAN BE SUPPLIED SEPARATELY

CODICE CODE	DESCRIZIONE DESCRIPTION	Q. TÀ QTY
37740	IMPUGNATURA IN LEGA DI ALLUMINIO GRIP IN ALUMINIUM ALLOY	1
38010	TERMINALE FLESSIBILE (Art. 37741) FLEXIBLE TERMINAL (Art. 37741)	1
38011	TERMINALE RIGIDO (Art. 37742) RIGID TERMINAL (Art. 37742)	1
38012	TERMINALE ALTA PORTATA (Art. 37743) HIGH DELIVERY RIGID TERMINAL (Art. 37743)	1
38016	UGELLO SALVAGOCCE SEMIAUTOMATICO SEMIAUTOMATIC DRIP-CATCHER NOZZLE	1
38062	SNODO GIREVOLE SWIVEL JOINT	1
KC352	FILTRO PISTOLA 3/8" FILTER GUN 3/8"	1

Art. KR3753 KIT GUARNIZIONI COMPLETO
COMPOSTO DALLE GUARNIZIONI SOTTO ELENcate JOINTS GASKETS LIST INCLUDING ALL THE GASKETS SHOWN HERE UNDER

CODICE CODE	DESCRIZIONE DESCRIPTION	Q. TÀ QTY
B132	SPILLO VALVOLA VALVE PIN	1
H093	O-RING 2050 "VITON" O-RING 2050 "VITON"	1
H229	O-RING 106 "VITON" O-RING 106 "VITON"	3
H230	O-RING 2025 "VITON 90SH" O-RING 2025 "VITON 90SH"	1
H231	O-RING 2056 "VITON" O-RING 2056 "VITON"	1
H457	O-RING 123 "VITON" O-RING 123 "VITON"	1
H515	O-RING 2043 "VITON" O-RING 2043 "VITON"	2
H518	O-RING 2068 "VITON" O-RING 2068 "VITON"	1
KC352	FILTRO PISTOLA 3/8" FILTER GUN 3/8"	1

Art. KS3783 SET RICAMBI CONSIGLIATI
AI PUNTI VENDITA E ASSISTENZA, COMPOSTO DAI RICAMBI SOTTO ELENcati TO THE REPAIR CENTERS. THIS KIT INCLUDES ALL THE SPARE PARTS SHOWN HERE UNDER

SPARE PARTS KIT ADVISED

CODICE CODE	DESCRIZIONE DESCRIPTION	Q. TÀ QTY
KR3716	VALVOLA PISTOLA OIL GUN VALVE	1
KR3753	KIT GUARNIZIONI COMPLETO COMPLETE GASKETS KIT	1



Art. 37750 - Art. 37751 - Art. 37752 - Art. 33140

VISTA ESPLOSA - EXPLODED VIEW

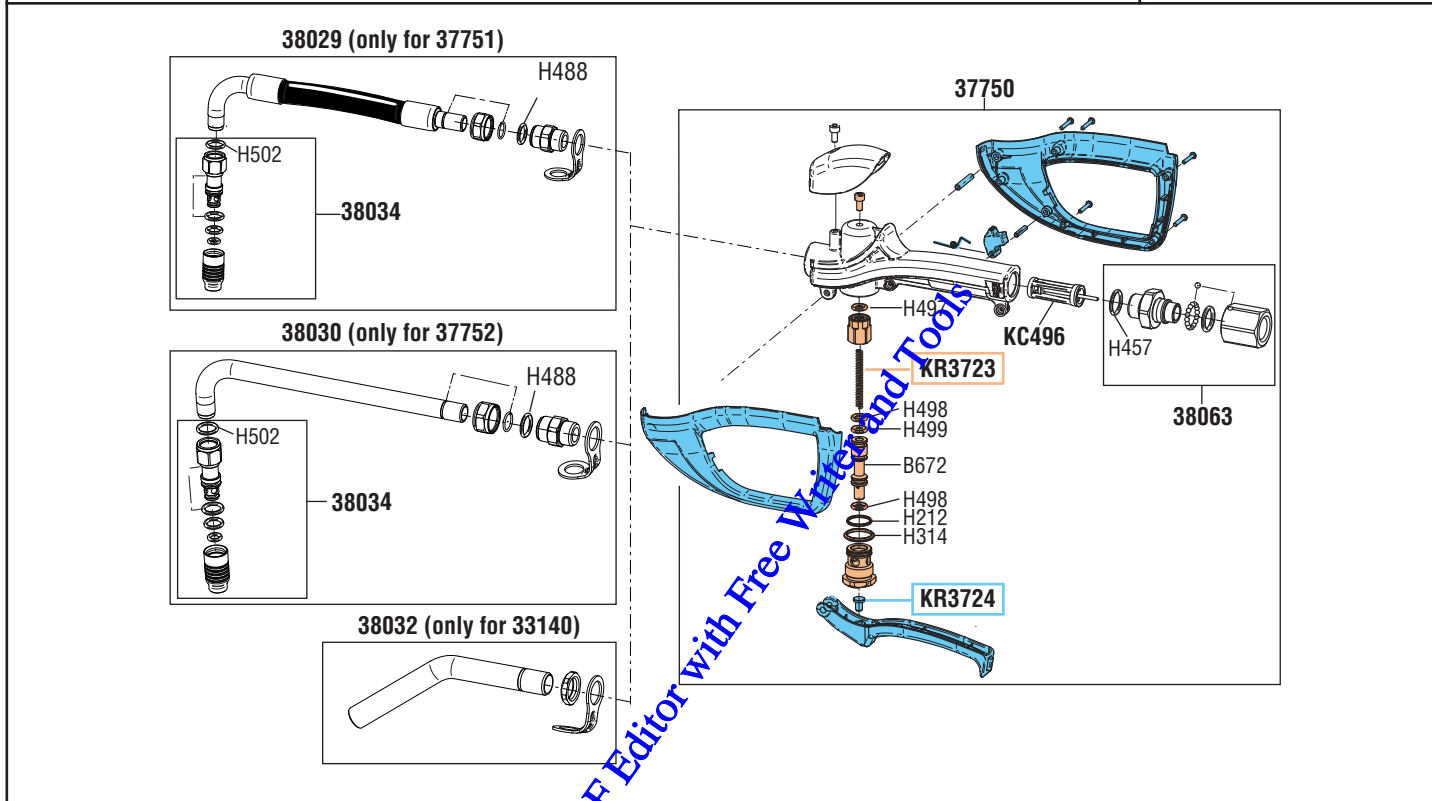
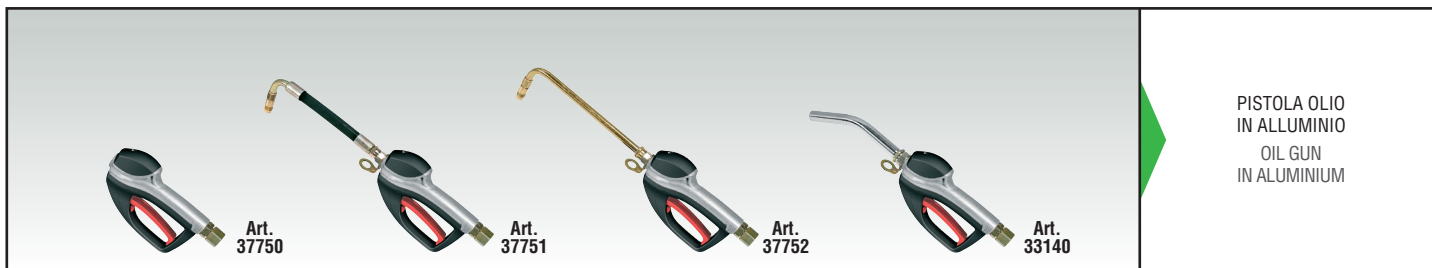

GUIDA RICAMBI - SPARE PARTS GUIDE

KIT RICAMBI
OGNI KIT SOTTO RIPORTATO COMPRENDE I RICAMBI EVIDENZIATI CON LO STESSO COLORE E LE RELATIVE GUARNIZIONI. QUESTI RICAMBI NON SONO FORNIBILI SEPARATAMENTE TRANNE QUELLI CODIFICATI.

SPARE PARTS KITS
EACH KIT SHOWN WITH THE SAME COLOR INCLUDES ALSO THE GASKETS. THE SPARE PARTS INCLUDED IN THE KIT CAN'T BE SUPPLIED SEPARATELY EXCEPT THOSE SHOWN WITH A PROPER CODE.

CODICE CODE	DESCRIZIONE DESCRIPTION	Q.TÀ QTY
KR3723	VALVOLA PISTOLA 1/2" OIL GUN VALVE 1/2"	1
KR3724	LEVA E PULSANTE PISTOLA OLIO OIL GUN LEVER AND LOCKING BUTTON	1

ELENCO RICAMBI FORNIBILI SINGOLARMENTE
LIST OF SPARE PARTS WHICH CAN BE SUPPLIED SEPARATELY

CODICE CODE	DESCRIZIONE DESCRIPTION	Q.TÀ QTY
37750	IMPUGNATURA IN LEGA DI ALLUMINIO GRIP IN ALUMINIUM ALLOY	1
38029	TERMINALE FLESSIBILE (Art. 37751) FLEXIBLE TERMINAL (Art. 37751)	1
38030	TERMINALE RIGIDO (Art. 37752) RIGID TERMINAL (Art. 37752)	1
38032	TERMINALE ALTA PORTATA (Art. 33140) HIGH DELIVERY RIGID TERMINAL (Art. 33140)	1
38034	UGELLO SALVAGOCCE SEMIAUTOMATICO SEMIAUTOMATIC DRIP-CATCHER NOZZLE	1
38063	SNODO GIREVOLE SWIVEL JOINT	1
KC496	FILTRO PISTOLA 1/2" FILTER GUN 1/2"	1

Art. KR3756 **KIT GUARNIZIONI COMPLETO**
COMPOSTO DALLE GUARNIZIONI SOTTO ELENCAE JOINTS GASKETS LIST INCLUDING ALL THE GASKETS SHOWN HERE UNDER

CODICE CODE	DESCRIZIONE DESCRIPTION	Q.TÀ QTY
B672	SPILLO VALVOLA VALVE PIN	1
H212	O-RING 2075 "VITON" O-RING 2075 "VITON"	1
H314	O-RING 128 "VITON" O-RING 128 "VITON"	1
H457	O-RING 123 "VITON" O-RING 123 "VITON"	1
H488	O-RING 121 "VITON" O-RING 121 "VITON"	1
H497	O-RING 3030 "VITON" O-RING 3030 "VITON"	1
H498	O-RING 109 "VITON" O-RING 109 "VITON"	2
H499	O-RING 109 "VITON 90SH" O-RING 109 "VITON 90SH"	1
H502	O-RING 3056 "VITON" O-RING 3056 "VITON"	1
KC496	FILTRO PISTOLA 1/2" FILTER GUN 1/2"	1

Art. KS3786 **SET RICAMBI CONSIGLIATI**
AI PUNTI VENDITA E ASSISTENZA, COMPOSTO DAI RICAMBI SOTTO ELENCAE TO THE REPAIR CENTERS. THIS KIT INCLUDES ALL THE SPARE PARTS SHOWN HERE UNDER

SPARE PARTS KIT ADVISED

CODICE CODE	DESCRIZIONE DESCRIPTION	Q.TÀ QTY
KR3723	VALVOLA PISTOLA OIL GUN VALVE	1
KR3756	KIT GUARNIZIONI COMPLETO COMPLETE GASKETS KIT	1

tutti i diritti riservati - all rights reserved



Art. 37758 - Art. 37759 - Art. 37760

VISTA ESPLOSA - EXPLODED VIEW

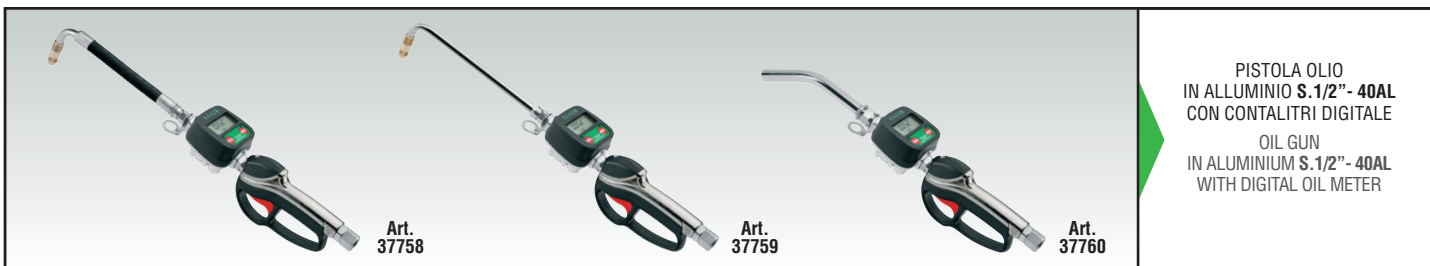

PISTOLA OLIO
IN ALLUMINIO S. 1/2" - 40AL
CON CONTALITRI DIGITALE
OIL GUN
IN ALUMINIUM S. 1/2" - 40AL
WITH DIGITAL OIL METER

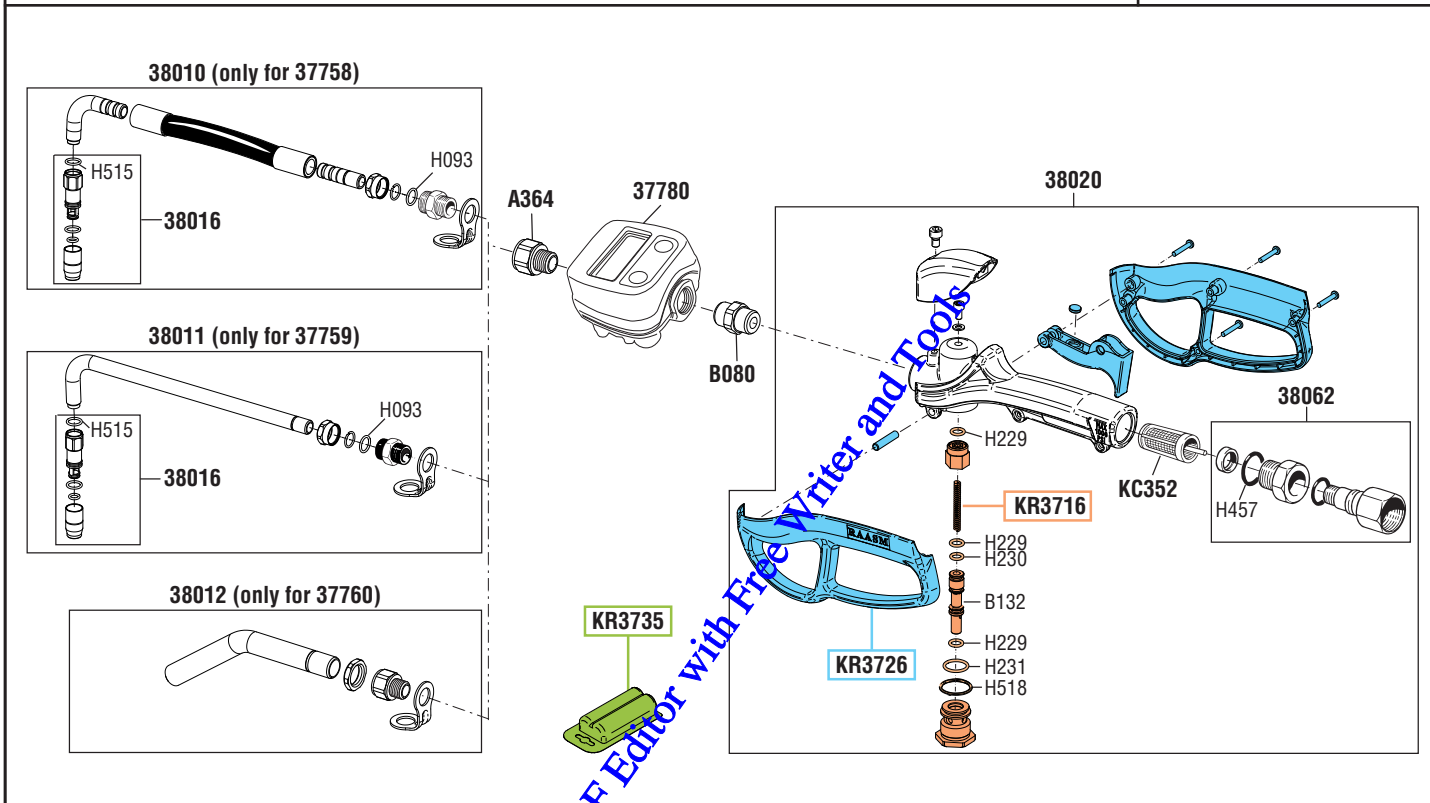

tutti i diritti riservati - all rights reserved

GUIDA RICAMBI - SPARE PARTS GUIDE

KIT RICAMBI
OGNI KIT SOTTO RIPORTATO COMPRENDE I RICAMBI EVIDENZIATI CON LO STESSO COLORE E LE RELATIVE GUARNIZIONI. QUESTI RICAMBI NON SONO FORNIBILI SEPARATAMENTE TRANNE QUELLI CODIFICATI.

SPARE PARTS KITS
EACH KIT SHOWN WITH THE SAME COLOR INCLUDES ALSO THE GASKETS. THE SPARE PARTS INCLUDED IN THE KIT CAN'T BE SUPPLIED SEPARATELY EXCEPT THOSE SHOWN WITH A PROPER CODE.

CODICE CODE	DESCRIZIONE DESCRIPTION	Q.TÀ QTY
KR3716	VALVOLA PISTOLA 3/8" OIL GUN VALVE 3/8"	1
KR3726	LEVA E PULSANTE PISTOLA OLIO OIL GUN LEVER AND LOCKING BUTTON	1
KR3735	KIT 2 BATTERIE MINISTILO "AAA" 1,5V AAA 1.5V PENLIGHT BATTERY KITS	1

ELENCO RICAMBI FORNIBILI SINGOLARMENTE
LIST OF SPARE PARTS WHICH CAN BE SUPPLIED SEPARATELY

CODICE CODE	DESCRIZIONE DESCRIPTION	Q.TÀ QTY
37780	CONTALITRI DIGITALE "RAASM" DIGITAL OIL METER "RAASM"	1
38010	TERMINALE FLESSIBILE (Art. 37758) FLEXIBLE TERMINAL (Art. 37758)	1
38011	TERMINALE RIGIDO (Art. 37759) RIGID TERMINAL (Art. 37759)	1
38012	TERMINALE ALTA PORTATA (Art. 37760) HIGH DELIVERY RIGID TERMINAL (Art. 37760)	1
38016	UGELLO SALVAGOCCE SEMIAUTOMATICO SEMIAUTOMATIC DRIP-CATCHER NOZZLE	1
38020	IMPUGNATURA IN LEGA DI ALLUMINIO GRIP IN ALUMINIUM ALLOY	1
38062	SNODO GIREVOLE SWIVEL JOINT	1
A364	RIDUZIONE M 1/2"G - F 3/8"G ADAPTOR M 1/2"G - F 3/8"G	1
B080	NIPPLE M 3/8" - M 1/2" NIPPLE M 3/8" - M 1/2"	1
KC352	FILTRO PISTOLA 3/8" FILTER GUN 3/8"	1

Art. KR3753 **KIT GUARNIZIONI COMPLETO**
COMPOSTO DALLE GUARNIZIONI SOTTO ELENCAE
JOINTS GASKETS LIST
INCLUDING ALL THE GASKETS SHOWN HERE UNDER

CODICE CODE	DESCRIZIONE DESCRIPTION	Q.TÀ QTY
B132	SPILLO VALVOLA VALVE PIN	1
H229	O-RING 106 "VITON" O-RING 106 "VITON"	3
H093	O-RING 2050 "VITON" O-RING 2050 "VITON"	1
H230	O-RING 2025 "VITON 90SH" O-RING 2025 "VITON 90SH"	1
H231	O-RING 2056 "VITON" O-RING 2056 "VITON"	1
H457	O-RING 123 "VITON" O-RING 123 "VITON"	1
H515	O-RING 2043 "VITON" O-RING 2043 "VITON"	1
H518	O-RING 2068 "VITON" O-RING 2068 "VITON"	1
KC352	FILTRO PISTOLA 3/8" FILTER GUN 3/8"	1

Art. KS3783 **SET RICAMBI CONSIGLIATI**
AI PUNTI VENDITA E ASSISTENZA,
COMPOSTO DAI RICAMBI SOTTO ELENCAE
SPARE PARTS KIT ADVISED
TO THE REPAIR CENTERS. THIS KIT INCLUDES
ALL THE SPARE PARTS SHOWN HERE UNDER

CODICE CODE	DESCRIZIONE DESCRIPTION	Q.TÀ QTY
KR3716	VALVOLA PISTOLA OIL GUN VALVE	1
KR3753	KIT GUARNIZIONI COMPLETO COMPLETE GASKETS KIT	1



Art. 37762 - Art. 37764



VISTA ESPLOSA - EXPLODED VIEW



PISTOLA ANTIGELO
IN ALLUMINIO S. 1/2" - 40AL
CON CONTALITRI DIGITALE
ANTIFREEZE GUN
IN ALUMINIUM S. 1/2" - 40AL
WITH DIGITAL OIL METER

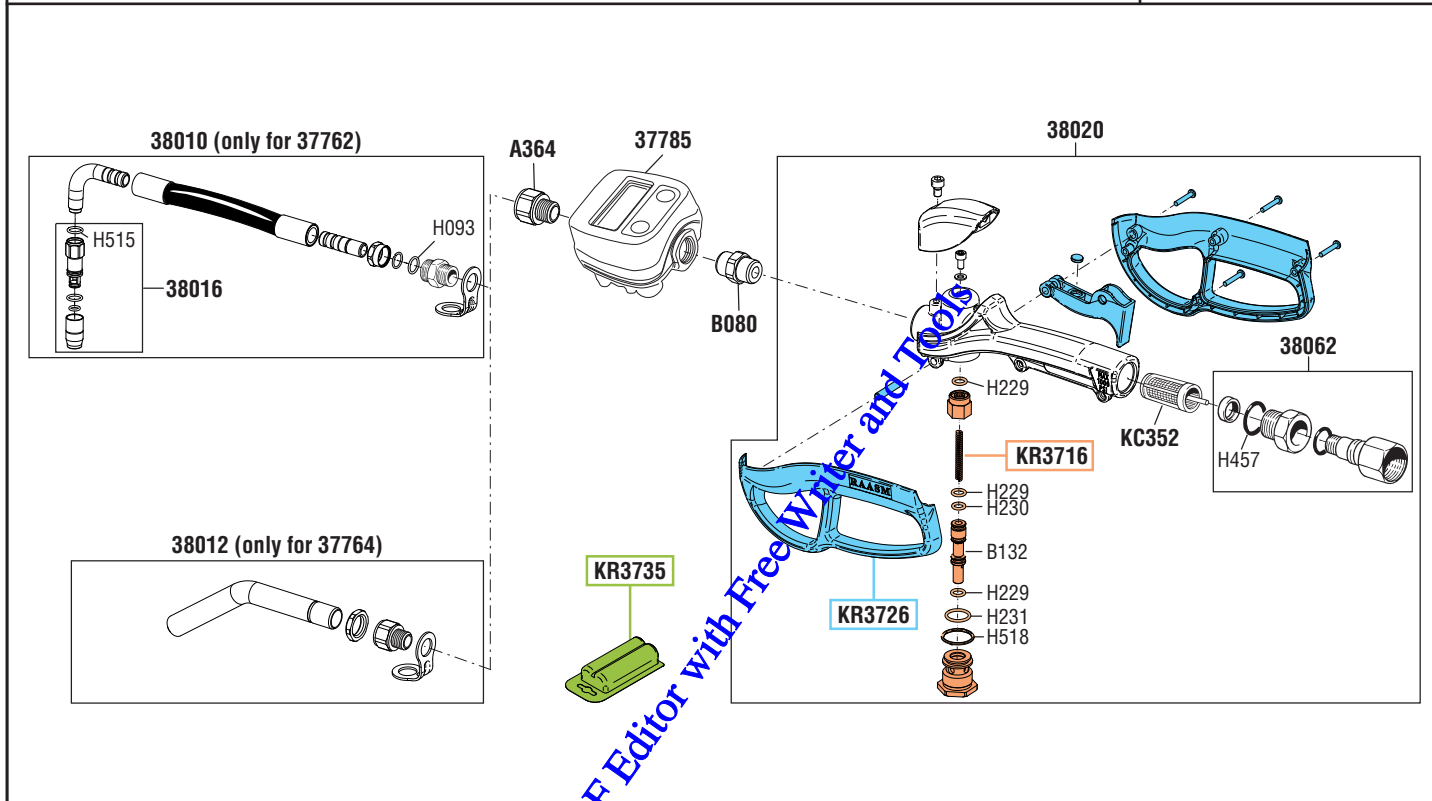

tutti i diritti riservati - all rights reserved

GUIDA RICAMBI - SPARE PARTS GUIDE

KIT RICAMBI
OGNI KIT SOTTO RIPORTATO COMPRENDE I RICAMBI EVIDENZIATI CON LO STESSO COLORE E LE RELATIVE GUARNIZIONI. QUESTI RICAMBI NON SONO FORNIBILI SEPARATAMENTE TRANNE QUELLI CODIFICATI.

SPARE PARTS KITS
EACH KIT SHOWN WITH THE SAME COLOR INCLUDES ALSO THE GASKETS. THE SPARE PARTS INCLUDED IN THE KIT CAN'T BE SUPPLIED SEPARATELY EXCEPT THOSE SHOWN WITH A PROPER CODE.

CODICE CODE	DESCRIZIONE DESCRIPTION	Q.TÀ QTY
KR3716	VALVOLA PISTOLA 3/8" OIL GUN VALVE 3/8"	1
KR3726	LEVA E PULSANTE PISTOLA OLIO OIL GUN LEVER AND LOCKING BUTTON	1
KR3735	KIT 2 BATTERIE MINISTILO "AAA" 1,5V AAA 1.5V PENLIGHT BATTERY KITS	1

ELENCO RICAMBI FORNIBILI SINGOLARMENTE
LIST OF SPARE PARTS WHICH CAN BE SUPPLIED SEPARATELY

CODICE CODE	DESCRIZIONE DESCRIPTION	Q.TÀ QTY
37785	CONTALITRI DIGITALE ANTIGELO "RAASM" DIGITAL ANTIFREEZE METER "RAASM"	1
38010	TERMINALE FLESSIBILE (Art. 37762) FLEXIBLE TERMINAL (Art. 37762)	1
38012	TERMINALE ALTA PORTATA (Art. 37764) HIGH DELIVERY RIGID TERMINAL (Art. 37764)	1
38016	UGELLO SALVAGOCCE SEMIAUTOMATICO SEMIAUTOMATIC DRIP-CATCHER NOZZLE	1
38020	IMPUGNATURA IN LEGA DI ALLUMINIO GRIP IN ALUMINIUM ALLOY	1
38062	SNODO GIREVOLE SWIVEL JOINT	1
A364	RIDUZIONE M 1/2"G - F 3/8"G ADAPTOR M 1/2"G - F 3/8"G	1
B080	NIPPLE M 3/8" - M 1/2" NIPPLE M 3/8" - M 1/2"	1
KC352	FILTRO PISTOLA 3/8" FILTER GUN 3/8"	1

Art. KR3753 KIT GUARNIZIONI COMPLETO
COMPOSTO DALLE GUARNIZIONI SOTTO ELENCAE
JOINTS GASKETS LIST INCLUDING ALL THE GASKETS SHOWN HERE UNDER

CODICE CODE	DESCRIZIONE DESCRIPTION	Q.TÀ QTY
B132	SPILLO VALVOLA VALVE PIN	1
H229	O-RING 106 "VITON" O-RING 106 "VITON"	3
H093	O-RING 2050 "VITON" O-RING 2050 "VITON"	1
H230	O-RING 2025 "VITON 90SH" O-RING 2025 "VITON 90SH"	1
H231	O-RING 2056 "VITON" O-RING 2056 "VITON"	1
H457	O-RING 123 "VITON" O-RING 123 "VITON"	1
H515	O-RING 2043 "VITON" O-RING 2043 "VITON"	1
H518	O-RING 2068 "VITON" O-RING 2068 "VITON"	1
KC352	FILTRO PISTOLA 3/8" FILTER GUN 3/8"	1

Art. KS3783 SET RICAMBI CONSIGLIATI
AI PUNTI VENDITA E ASSISTENZA, COMPOSTO DAI RICAMBI SOTTO ELENCAE
SPARE PARTS KIT ADVISED TO THE REPAIR CENTERS. THIS KIT INCLUDES ALL THE SPARE PARTS SHOWN HERE UNDER

CODICE CODE	DESCRIZIONE DESCRIPTION	Q.TÀ QTY
KR3716	VALVOLA PISTOLA OIL GUN VALVE	1
KR3753	KIT GUARNIZIONI COMPLETO COMPLETE GASKETS KIT	1



Art. 37775 - Art. 37776 - Art. 37777 - Art. 37778

VISTA ESPLOSA - EXPLODED VIEW

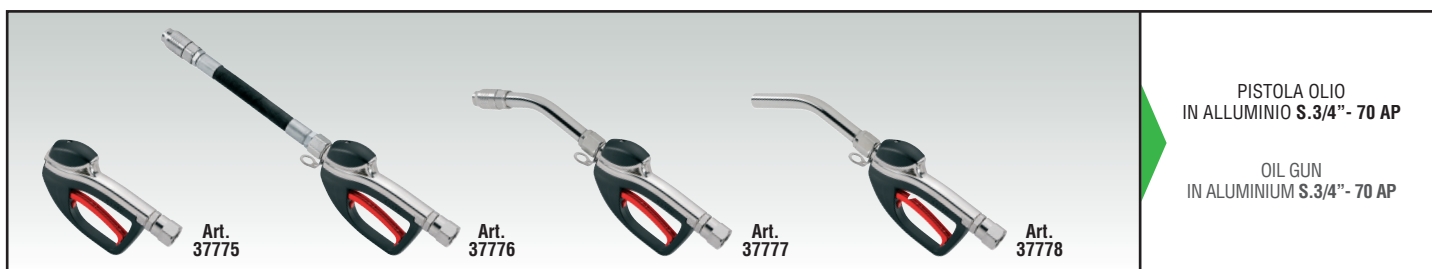

PISTOLA OLIO
IN ALLUMINIO S.3/4"- 70 AP

OIL GUN
IN ALUMINIUM S.3/4"- 70 AP

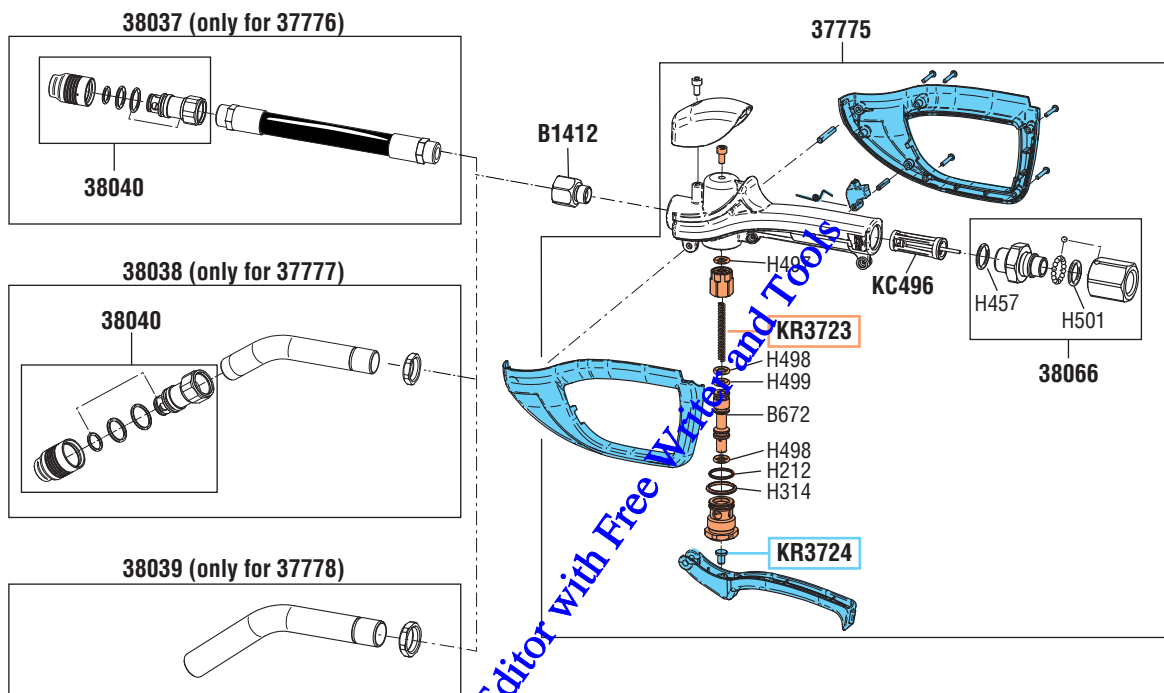

GUIDA RICAMBI - SPARE PARTS GUIDE

KIT RICAMBI
OGNI KIT SOTTO RIPORTATO COMPRENDE I RICAMBI EVIDENZIATI CON LO STESSO COLORE E LE RELATIVE GUARNIZIONI. QUESTI RICAMBI NON SONO FORNIBILI SEPARATAMENTE TRANNE QUELLI CODIFICATI.

SPARE PARTS KITS
EACH KIT SHOWN WITH THE SAME COLOR INCLUDES ALSO THE GASKETS. THE SPARE PARTS INCLUDED IN THE KIT CAN'T BE SUPPLIED SEPARATELY EXCEPT THOSE SHOWN WITH A PROPER CODE.

CODICE CODE	DESCRIZIONE DESCRIPTION	Q.TÀ QTY
KR3723	VALVOLA PISTOLA 1/2" OIL GUN VALVE 1/2"	1
KR3724	LEVA E PULSANTE PISTOLA OLIO OIL GUN LEVER AND LOCKING BUTTON	1

ELENCO RICAMBI FORNIBILI SINGOLARMENTE
LIST OF SPARE PARTS WHICH CAN BE SUPPLIED SEPARATELY

CODICE CODE	DESCRIZIONE DESCRIPTION	Q.TÀ QTY
37775	IMPUGNATURA IN LEGA DI ALLUMINIO GRIP IN ALUMINIUM ALLOY	1
38037	TERMINALE FLESSIBILE (Art. 37776) FLEXIBLE TERMINAL (Art. 37776)	1
38038	TERMINALE RIGIDO (Art. 37777) RIGID TERMINAL (Art. 37777)	1
38039	TERMINALE ALTA PORTATA (Art. 37778) HIGH DELIVERY RIGID TERMINAL (Art.37778)	1
38040	UGELLO SALVAGOCCE SEMIAUTOMATICO SEMIAUTOMATIC DRIP-CATCHER NOZZLE	1
38066	SNODO GIREVOLE SWIVEL JOINT	1
B1412	NIPPLE M 1/2"G - F 3/4"G NIPPLE M 1/2"G - F 3/4"G	1
KC496	FILTRO PISTOLA 1/2" FILTER GUN 1/2"	1

Art. KR3760 **KIT GUARNIZIONI COMPLETO**
COMPOSTO DALLE GUARNIZIONI SOTTO ELENCAE JOINTS GASKETS LIST INCLUDING ALL THE GASKETS SHOWN HERE UNDER

CODICE CODE	DESCRIZIONE DESCRIPTION	Q.TÀ QTY
B672	SPILLO VALVOLA VALVE PIN	1
H212	O-RING 2075 "VITON" O-RING 2075 "VITON"	1
H314	O-RING 128 "VITON" O-RING 128 "VITON"	1
H457	O-RING 123 "VITON" O-RING 123 "VITON"	1
H497	O-RING 3030 "VITON" O-RING 3030 "VITON"	1
H498	O-RING 109 "VITON" O-RING 109 "VITON"	2
H501	O-RING "VITON" O-RING "VITON"	1
H499	O-RING 109 "VITON 90SH" O-RING 109 "VITON 90SH"	1
H502	O-RING 3056 "VITON" O-RING 3056 "VITON"	1
KC496	FILTRO PISTOLA 1/2" FILTER GUN 1/2"	1

Art. KS3788 **SET RICAMBI CONSIGLIATI**
AI PUNTI VENDITA E ASSISTENZA, COMPOSTO DAI RICAMBI SOTTO ELENCAE TO THE REPAIR CENTERS. THIS KIT INCLUDES ALL THE SPARE PARTS SHOWN HERE UNDER

SPARE PARTS KIT ADVISED

CODICE CODE	DESCRIZIONE DESCRIPTION	Q.TÀ QTY
KR3723	VALVOLA PISTOLA OIL GUN VALVE	1
KR3760	KIT GUARNIZIONI COMPLETO COMPLETE GASKETS KIT	1



Art. 37780 Mod. D.V.1/2"0



VISTA ESPLOSA - EXPLODED VIEW

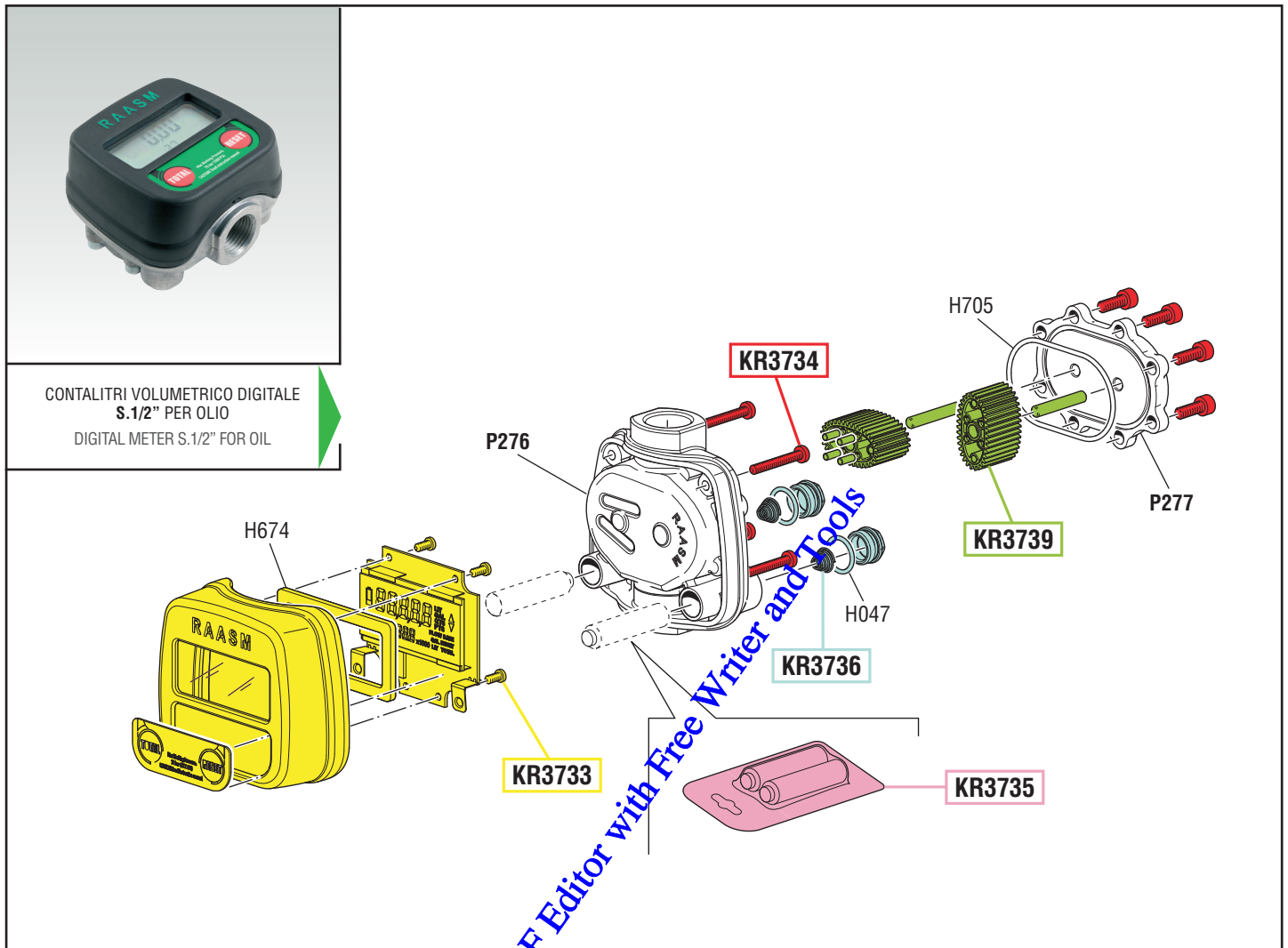

CONTALITRI VOLUMETRICO DIGITALE
S.1/2" PER OLIO
DIGITAL METER S.1/2" FOR OIL

GUIDA RICAMBI - SPARE PARTS GUIDE

KIT RICAMBI

OGNI KIT SOTTO RIPIORTATO COMPRENDE I RICAMBI EVIDENZIATI CON LO STESSO COLORE E LE RELATIVE GUARNIZIONI. QUESTI RICAMBI NON SONO FORNIBILI SEPARATAMENTE TRANNE QUELLI CODIFICATI.

SPARE PARTS KITS

EACH KIT SHOWN WITH THE SAME COLOR INCLUDES ALSO THE GASKETS. THE SPARE PARTS INCLUDED IN THE KIT CAN'T BE SUPPLIED SEPARATELY EXCEPT THOSE SHOWN WITH A PROPER CODE.

CODICE CODE	DESCRIZIONE DESCRIPTION	Q.TÀ QTY
KR3733	GRUPPO COPERCHIO DISPLAY-CIRCUITO STAMPATO PROTECTIVE COVER-ELECTRONICS BOARD	1
KR3734	SET VITI SET OF SCREWS	1
KR3735	BATTERIE MINI STILO TIPO "AAA" 1,5V BATTERIES 1,5 SIZE "AAA"	1
KR3736	GRUPPO TAPPI ERMETICI BATTERIA HERMETIC BATTERY PLUGS GROUP	1
KR3739	GRUPPO INGRANAGGI OVALI-POM (DEL RIN 100P) OVAL GEARS GROUP-POM (DEL RIN 100P)	1

ELENCO RICAMBI FORNIBILI SINGOLARMENTE

LIST OF SPARE PARTS WHICH CAN BE SUPPLIED SEPARATELY

CODICE CODE	DESCRIZIONE DESCRIPTION	Q.TÀ QTY
P276	CORPO CONTALITRI ALLUMINIUM DIGITAL METER BODY	1
P277	COPERCHIO PER CORPO CONTALITRI BODY DIGITAL METER COVER	1

Art.
KR3759

KIT GUARNIZIONI COMPLETO

COMPOSTO DALLE GUARNIZIONI SOTTO ELENCAE
JOINTS GASKETS LIST
INCLUDING ALL THE GASKETS SHOWN HERE UNDER

CODICE CODE	DESCRIZIONE DESCRIPTION	Q.TÀ QTY
H047	GUARNIZIONE OR 2050 "NBR" O-RING 2050 "NBR"	2
H674	GUARNIZIONE PER DISPLAY DISPLAY GASKET	1
H705	GUARNIZIONE "VITON" O-RING "VITON"	1

tutti i diritti riservati - all rights reserved



Art. 37781 Mod. D.V.3/4"0



VISTA ESPLOSA - EXPLODED VIEW



CONTALITRI VOLUMETRICO DIGITALE
S.3/4" PER OLIO
DIGITAL METER S.3/4" FOR OIL

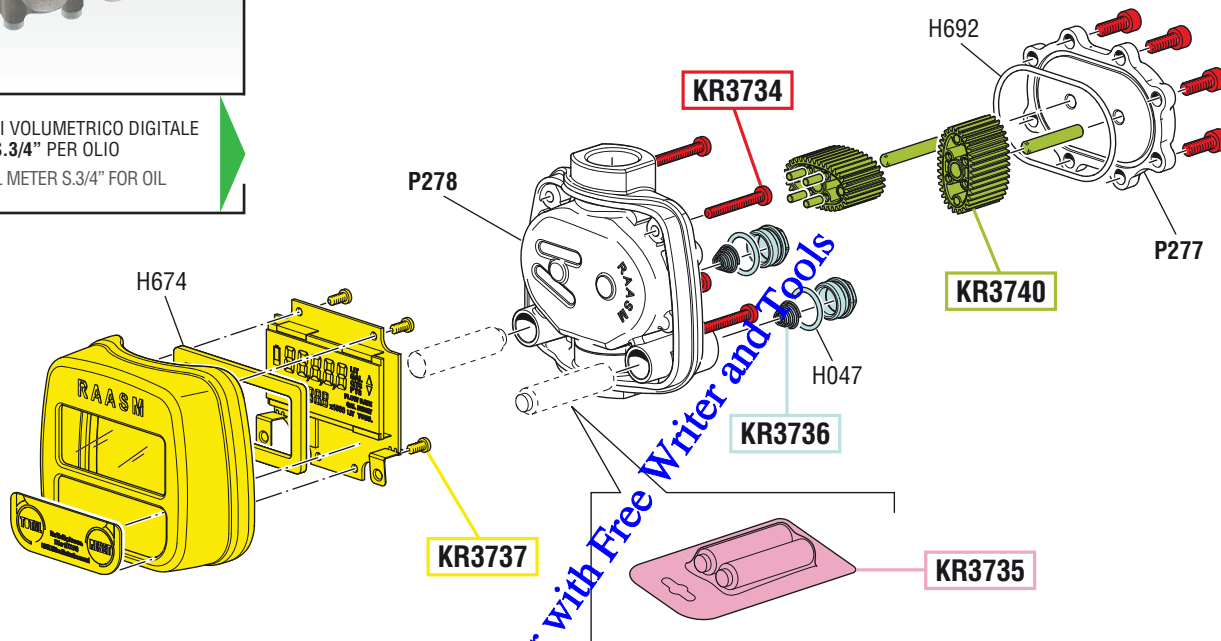

GUIDA RICAMBI - SPARE PARTS GUIDE

KIT RICAMBI
OGNI KIT SOTTO RIPORTATO COMPRENDE I RICAMBI EVIDENZIATI CON LO STESSO COLORE E LE RELATIVE GUARNIZIONI. QUESTI RICAMBI NON SONO FORNIBILI SEPARATAMENTE TRANNE QUELLI CODIFICATI.

SPARE PARTS KITS
EACH KIT SHOWN WITH THE SAME COLOR INCLUDES ALSO THE GASKETS. THE SPARE PARTS INCLUDED IN THE KIT CAN'T BE SUPPLIED SEPARATELY EXCEPT THOSE SHOWN WITH A PROPER CODE.

CODICE CODE	DESCRIZIONE DESCRIPTION	Q.TÀ QTY
KR3734	SET VITI SET OF SCREWS	1
KR3735	BATTERIE MINI STILO TIPO "AAA" 1,5V BATTERIES 1,5 SIZE "AAA"	1
KR3736	GRUPPO TAPPI ERMETICI BATTERIA HERMETIC BATTERY PLUGS GROUP	1
KR3737	GRUPPO COPERCHIO DISPLAY-CIRCUITO STAMPATO PROTECTIVE COVER-ELECTRONICS BOARD	1
KR3740	GRUPPO INGRANAGGI OVALI-POM (DELRIIN 100P) OVAL GEARS GROUP-POM (DELRIIN 100P)	1

ELENCO RICAMBI FORNIBILI SINGOLARMENTE
LIST OF SPARE PARTS WHICH CAN BE SUPPLIED SEPARATELY

CODICE CODE	DESCRIZIONE DESCRIPTION	Q.TÀ QTY
P277	COPERCHIO PER CORPO CONTALITRI BODY DIGITAL METER COVER	1
P278	CORPO CONTALITRI ALLUMINIUM DIGITAL METER BODY	1

Art. KR3760
KIT GUARNIZIONI COMPLETO
COMPOSTO DALLE GUARNIZIONI SOTTO ELENCAE
JOINTS GASKETS LIST
INCLUDING ALL THE GASKETS SHOWN HERE UNDER

CODICE CODE	DESCRIZIONE DESCRIPTION	Q.TÀ QTY
H047	GUARNIZIONE OR 2050 "NBR" O-RING 2050 "NBR"	2
H674	GUARNIZIONE PER DISPLAY DISPLAY GASKET	1
H692	GUARNIZIONE "NBR" O-RING "NBR"	1

tutti i diritti riservati - all rights reserved



Art. 37785 Mod. D.V.1/2"L



VISTA ESPLOSA - EXPLODED VIEW

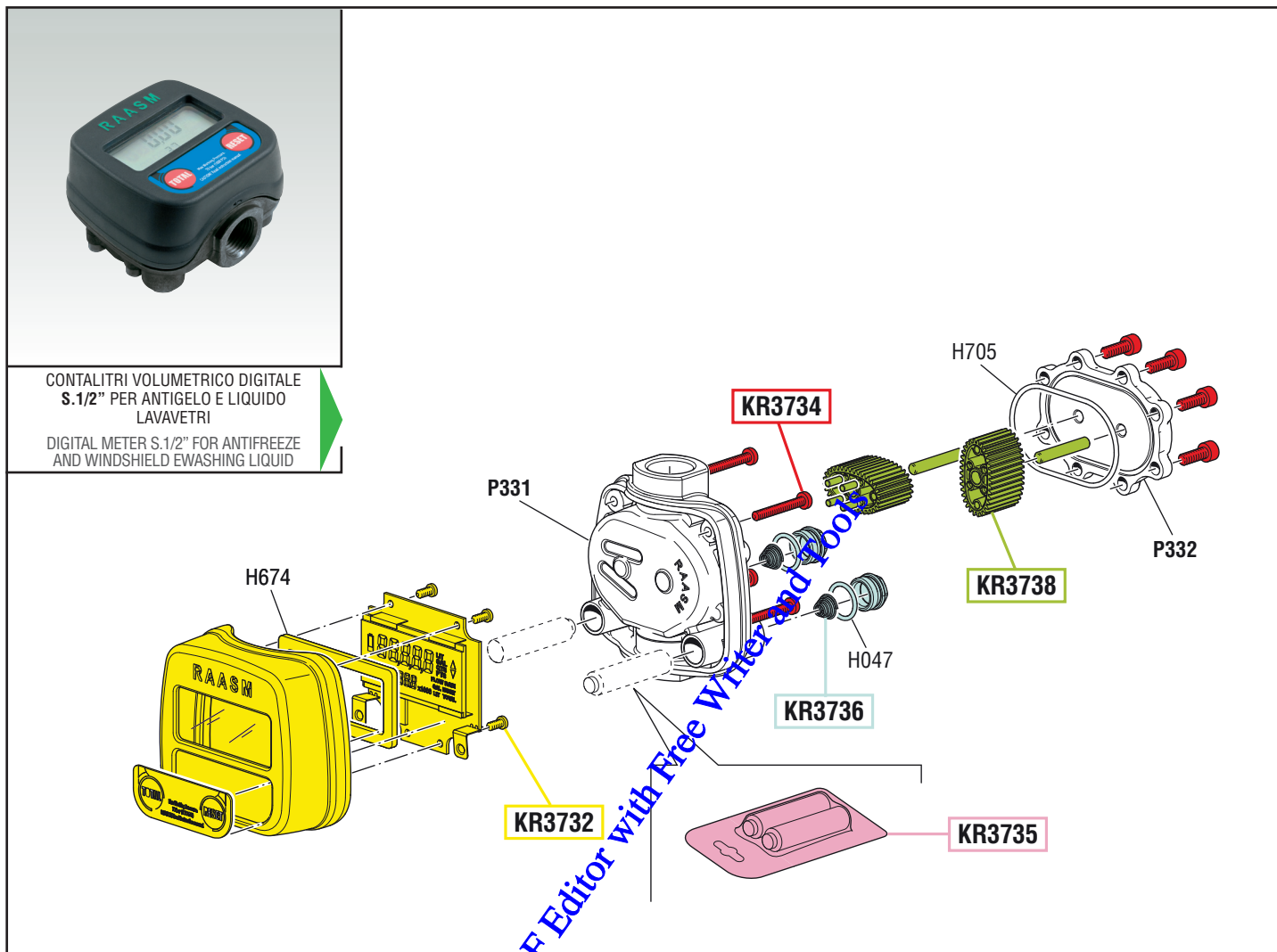

CONTALITRI VOLUMETRICO DIGITALE
S.1/2" PER ANTIFREZZO E LIQUIDO
LAVAVETRI

DIGITAL METER S.1/2" FOR ANTIFREEZE
AND WINDSHIELD EWASHING LIQUID

GUIDA RICAMBI - SPARE PARTS GUIDE

KIT RICAMBI

OGNI KIT SOTTO RIPORTATO COMPRENDE I RICAMBI EVIDENZIATI CON LO STESSO COLORE E LE RELATIVE GUARNIZIONI. QUESTI RICAMBI NON SONO FORNIBILI SEPARATAMENTE TRANNE QUELLI CODIFICATI.

SPARE PARTS KITS

EACH KIT SHOWN WITH THE SAME COLOR INCLUDES ALSO THE GASKETS. THE SPARE PARTS INCLUDED IN THE KIT CAN'T BE SUPPLIED SEPARATELY EXCEPT THOSE SHOWN WITH A PROPER CODE.

CODICE CODE	DESCRIZIONE DESCRIPTION	Q.TÀ QTY
KR3732	GRUPPO COPERCHIO DISPLAY-CIRCUITO STAMPATO PROTECTIVE COVER-ELECTRONICS BOARD	1
KR3734	SET VITI SET OF SCREWS	1
KR3735	BATTERIE MINI STILO TIPO "AAA" 1,5V BATTERIES 1,5 SIZE "AAA"	1
KR3736	GRUPPO TAPPI ERMETICI BATTERIA HERMETIC BATTERY PLUGS GROUP	1
KR3738	GRUPPO INGRANAGGI OVALI-PVDF (SOLEF 1008) OVAL GEARS GROUP-PVDF (SOLEF 1008)	1

ELENCO RICAMBI FORNIBILI SINGOLARMENTE

LIST OF SPARE PARTS WHICH CAN BE SUPPLIED SEPARATELY

CODICE CODE	DESCRIZIONE DESCRIPTION	Q.TÀ QTY
P331	CORPO CONTALITRI ALLUMINIUM DIGITAL METER BODY	1
P332	COPERCHIO PER CORPO CONTALITRI BODY DIGITAL METER COVER	1

Art.
KR3759

KIT GUARNIZIONI COMPLETO

COMPOSTO DALLE GUARNIZIONI SOTTO ELENCAE
JOINTS GASKETS LIST
INCLUDING ALL THE GASKETS SHOWN HERE UNDER

CODICE CODE	DESCRIZIONE DESCRIPTION	Q.TÀ QTY
H047	GUARNIZIONE OR 2050 "NBR" O-RING 2050 "NBR"	2
H674	GUARNIZIONE PER DISPLAY DISPLAY GASKET	1
H705	GUARNIZIONE "VITON" O-RING "VITON"	1

tutti i diritti riservati - all rights reserved



Art. 37786 - Art. 37787 - Art. 37788

VISTA ESPLOSA - EXPLODED VIEW

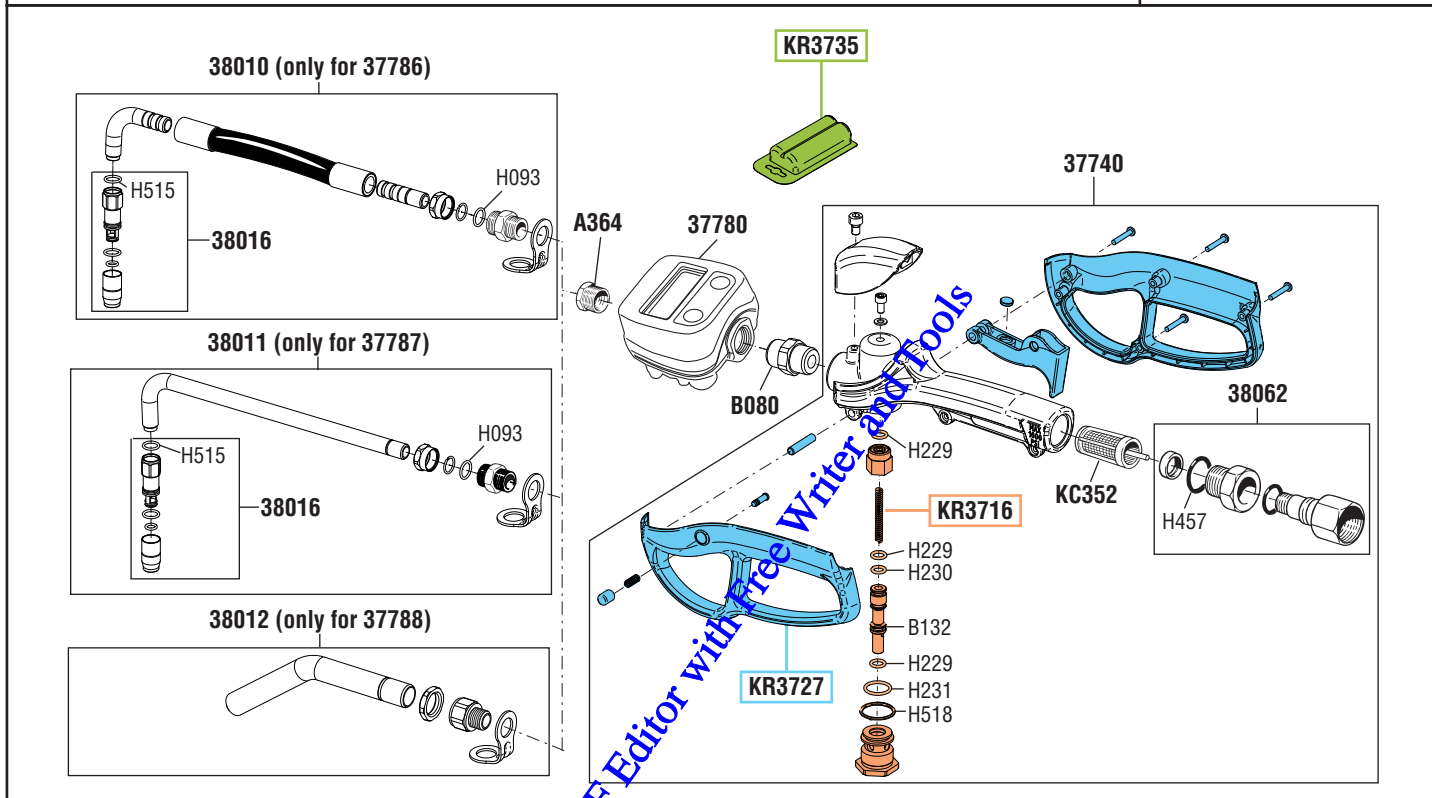
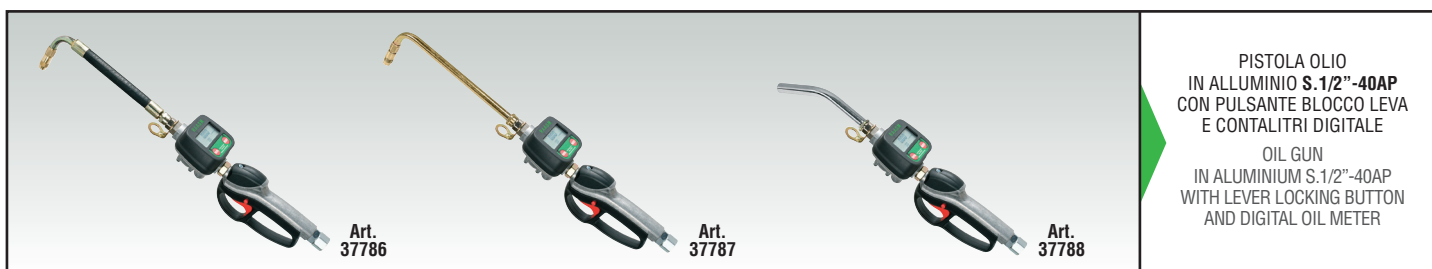

GUIDA RICAMBI - SPARE PARTS GUIDE

KIT RICAMBI
OGNI KIT SOTTO RIPORTATO COMPRENDE I RICAMBI EVIDENZIATI CON LO STESSO COLORE E LE RELATIVE GUARNIZIONI. QUESTI RICAMBI NON SONO FORNIBILI SEPARATAMENTE TRANNE QUELLI CODIFICATI.

SPARE PARTS KITS
EACH KIT SHOWN WITH THE SAME COLOR INCLUDES ALSO THE GASKETS. THE SPARE PARTS INCLUDED IN THE KIT CAN'T BE SUPPLIED SEPARATELY EXCEPT THOSE SHOWN WITH A PROPER CODE.

CODICE CODE	DESCRIZIONE DESCRIPTION	Q.TÀ QTY
KR3716	VALVOLA PISTOLA 3/8" OIL GUN VALVE 3/8"	1
KR3726	LEVA E PULSANTE PISTOLA OLIO OIL GUN LEVER AND LOCKING BUTTON	1
KR3735	KIT 2 BATTERIE MINISTILO "AAA" 1,5V AAA 1.5V PENLIGHT BATTERY KITS	1

ELENCO RICAMBI FORNIBILI SINGOLARMENTE
LIST OF SPARE PARTS WHICH CAN BE SUPPLIED SEPARATELY

CODICE CODE	DESCRIZIONE DESCRIPTION	Q.TÀ QTY
37740	IMPUGNATURA IN LEGA DI ALLUMINIO GRIP IN ALUMINIUM ALLOY	1
37780	CONTALITRI DIGITALE "RAASM" DIGITAL OIL METER "RAASM"	1
38010	TERMINALE FLESSIBILE (Art. 37786) FLEXIBLE TERMINAL (Art. 37786)	1
38011	TERMINALE RIGIDO (Art. 37787) RIGID TERMINAL (Art. 37787)	1
38012	TERMINALE ALTA PORTATA (Art. 37788) HIGH DELIVERY RIGID TERMINAL (Art. 37788)	1
38016	UGELLO SALVAGOCCE SEMIAUTOMATICO SEMIAUTOMATIC DRIP-CATCHER NOZZLE	1
38062	SNODO GIREVOLE SWIVEL JOINT	1
A364	ADATTATORE M 1/2" G x F 3/8" G ADAPTOR M 1/2" G x F 3/8" G	1
B080	NIPPLO M 3/8" G x M 1/2" G NIPPLE M 3/8" G x M 1/2" G	1
KC352	FILTRO PISTOLA 3/8" FILTER GUN 3/8"	1

Art. KR3753
KIT GUARNIZIONI COMPLETO
COMPOSTO DALLE GUARNIZIONI SOTTO ELENCAE JOINTS GASKETS LIST INCLUDING ALL THE GASKETS SHOWN HERE UNDER

CODICE CODE	DESCRIZIONE DESCRIPTION	Q.TÀ QTY
B132	SPILLO VALVOLA VALVE PIN	1
H093	O-RING 2050 "VITON" O-RING 2050 "VITON"	1
H229	O-RING 106 "VITON" O-RING 106 "VITON"	3
H230	O-RING 2025 "VITON 90SH" O-RING 2025 "VITON 90SH"	1
H231	O-RING 2056 "VITON" O-RING 2056 "VITON"	1
H457	O-RING 123 "VITON" O-RING 123 "VITON"	1
H515	O-RING 2043 "VITON" O-RING 2043 "VITON"	2
H518	O-RING 2068 "VITON" O-RING 2068 "VITON"	1
KC352	FILTRO PISTOLA 3/8" FILTER GUN 3/8"	1

Art. KS3783
SET RICAMBI CONSIGLIATI
AI PUNTI VENDITA E ASSISTENZA, COMPOSTO DAI RICAMBI SOTTO ELENCAE TO THE REPAIR CENTERS. THIS KIT INCLUDES ALL THE SPARE PARTS SHOWN HERE UNDER

SPARE PARTS KIT ADVISED

CODICE CODE	DESCRIZIONE DESCRIPTION	Q.TÀ QTY
KR3716	VALVOLA PISTOLA OIL GUN VALVE	1
KR3753	KIT GUARNIZIONI COMPLETO COMPLETE GASKETS KIT	1

tutti i diritti riservati - all rights reserved



Art. 37794 - Art. 37795 - Art. 37796

VISTA ESPLOSA - EXPLODED VIEW

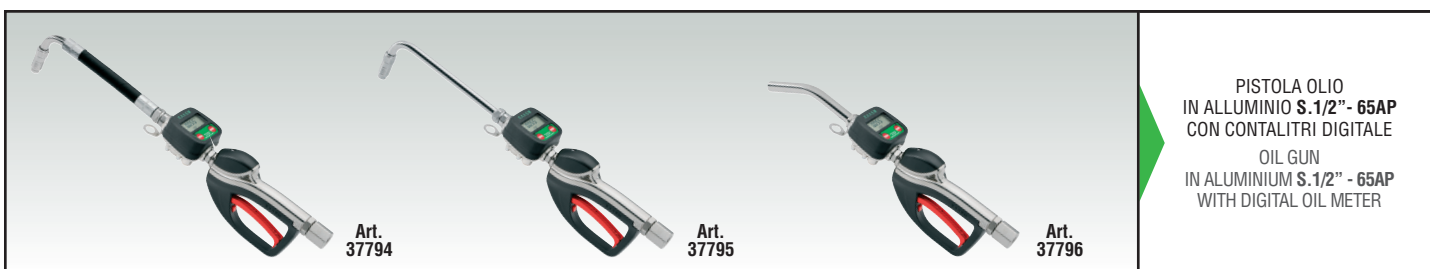

PISTOLA OLIO
IN ALLUMINIO S.1/2" - 65AP
CON CONTALITRI DIGITALE
OIL GUN
IN ALUMINIUM S.1/2" - 65AP
WITH DIGITAL OIL METER

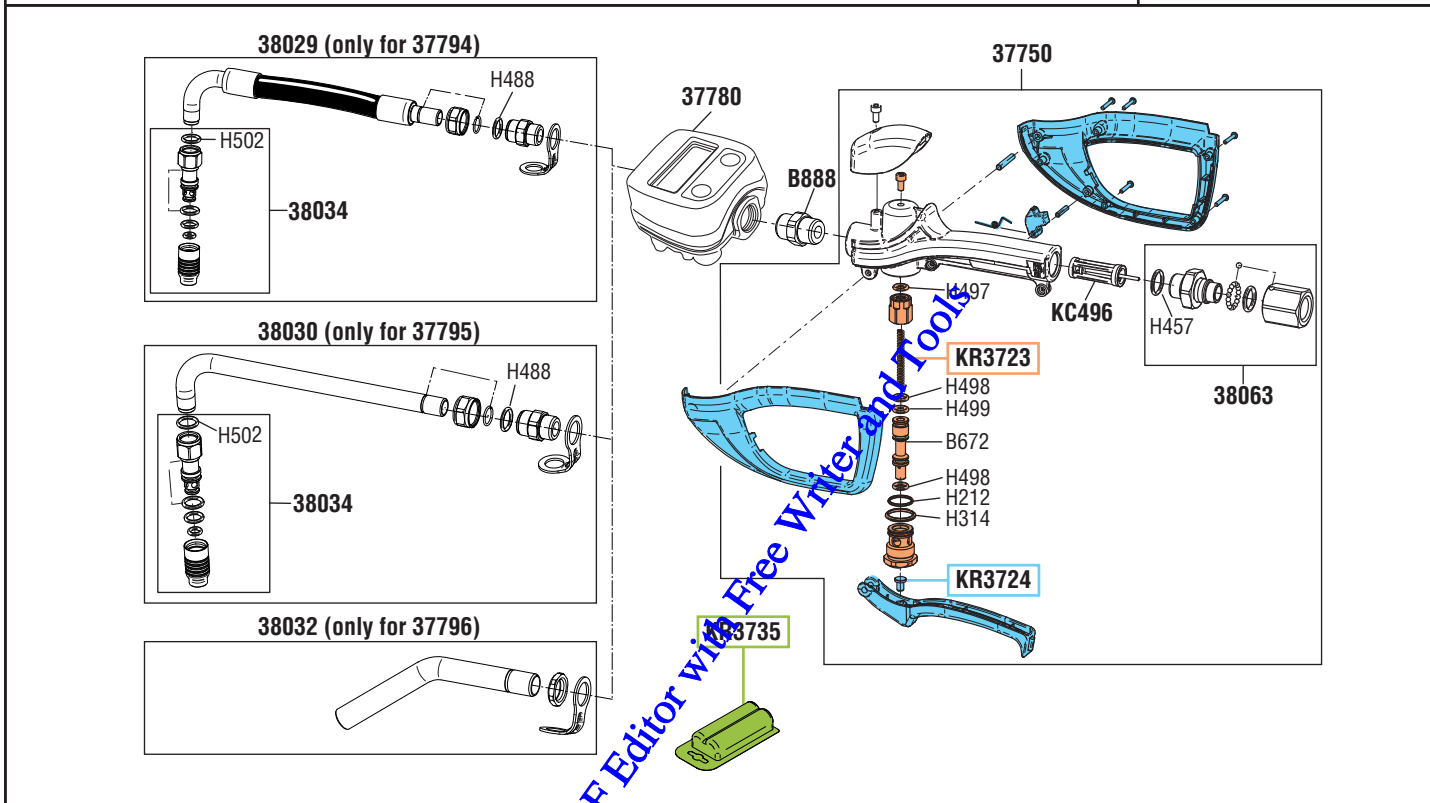

tutti i diritti riservati - all rights reserved

GUIDA RICAMBI - SPARE PARTS GUIDE

KIT RICAMBI
OGNI KIT SOTTO RIPORTATO COMPRENDE I RICAMBI EVIDENZIATI CON LO STESSO COLORE E LE RELATIVE GUARNIZIONI. QUESTI RICAMBI NON SONO FORNIBILI SEPARATAMENTE TRANNE QUELLI CODIFICATI.

SPARE PARTS KITS
EACH KIT SHOWN WITH THE SAME COLOR INCLUDES ALSO THE GASKETS. THE SPARE PARTS INCLUDED IN THE KIT CAN'T BE SUPPLIED SEPARATELY EXCEPT THOSE SHOWN WITH A PROPER CODE.

CODICE CODE	DESCRIZIONE DESCRIPTION	Q.TÀ QTY
KR3723	VALVOLA PISTOLA 1/2" OIL GUN VALVE 1/2"	1
KR3724	LEVA E PULSANTE PISTOLA OLIO OIL GUN LEVER AND LOCKING BUTTON	1
KR3735	KIT 2 BATTERIE MINISTILO "AAA" 1,5V AAA 1.5V PENLIGHT BATTERY KITS	1

ELENCO RICAMBI FORNIBILI SINGOLARMENTE
LIST OF SPARE PARTS WHICH CAN BE SUPPLIED SEPARATELY

CODICE CODE	DESCRIZIONE DESCRIPTION	Q.TÀ QTY
37750	IMPUGNATURA IN LEGA DI ALLUMINIO GRIP IN ALUMINIUM ALLOY	1
37780	CONTALITRI DIGITALE "RAASM" 1/2" OLIO 1/2" DIGITAL OIL METER "RAASM"	1
38029	TERMINALE FLESSIBILE (Art. 37794) FLEXIBLE TERMINAL (Art. 37794)	1
38030	TERMINALE RIGIDO (Art. 37795) RIGID TERMINAL (Art. 37795)	1
38032	TERMINALE ALTA PORTATA (Art. 37796) HIGH DELIVERY RIGID TERMINAL (Art. 37796)	1
38034	UGELLO SALVAGOCCE SEMIAUTOMATICO SEMI-AUTOMATIC DRIP-CATCHER NOZZLE	1
38063	SNODO GIREVOLE SWIVEL JOINT	1
B888	NIPPLO 1/2" NIPPLE 1/2"	1
KC496	FILTRO PISTOLA 1/2" FILTER GUN 1/2"	1

Art. KR3756 **KIT GUARNIZIONI COMPLETO**
COMPOSTO DALLE GUARNIZIONI SOTTO ELENCAE
JOINTS GASKETS LIST
INCLUDING ALL THE GASKETS SHOWN HERE UNDER

CODICE CODE	DESCRIZIONE DESCRIPTION	Q.TÀ QTY
B672	SPILLO VALVOLA VALVE PIN	1
H212	O-RING 2075 "VITON" O-RING 2075 "VITON"	1
H314	O-RING 128 "VITON" O-RING 128 "VITON"	1
H457	O-RING 123 "VITON" O-RING 123 "VITON"	1
H488	O-RING 121 "VITON" O-RING 121 "VITON"	1
H497	O-RING 3030 "VITON" O-RING 3030 "VITON"	1
H498	O-RING 109 "VITON" O-RING 109 "VITON"	2
H499	O-RING 109 "VITON 90SH" O-RING 109 "VITON 90SH"	1
H502	O-RING 3056 "VITON" O-RING 3056 "VITON"	1
KC496	FILTRO PISTOLA 1/2" FILTER GUN 1/2"	1

Art. KS3786 **SET RICAMBI CONSIGLIATI**
AI PUNTI VENDITA E ASSISTENZA,
COMPOSTO DAI RICAMBI SOTTO ELENCAE
SPARE PARTS KIT ADVISED
TO THE REPAIR CENTERS. THIS KIT INCLUDES
ALL THE SPARE PARTS SHOWN HERE UNDER

CODICE CODE	DESCRIZIONE DESCRIPTION	Q.TÀ QTY
KR3723	VALVOLA PISTOLA OIL GUN VALVE	1
KR3756	KIT GUARNIZIONI COMPLETO COMPLETE GASKETS KIT	1



Art. 37797 - Art. 37798 - Art. 37799

VISTA ESPLOSA - EXPLODED VIEW

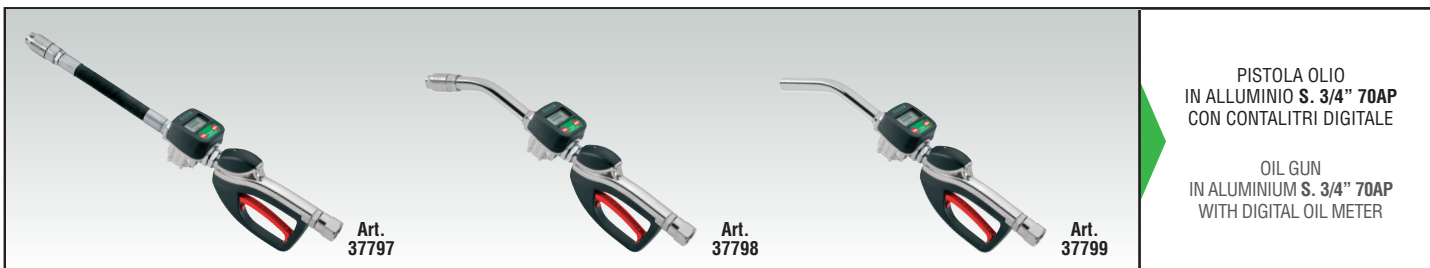

PISTOLA OLIO
IN ALLUMINIO S. 3/4" 70AP
CON CONTALITRI DIGITALE

OIL GUN
IN ALUMINIUM S. 3/4" 70AP
WITH DIGITAL OIL METER

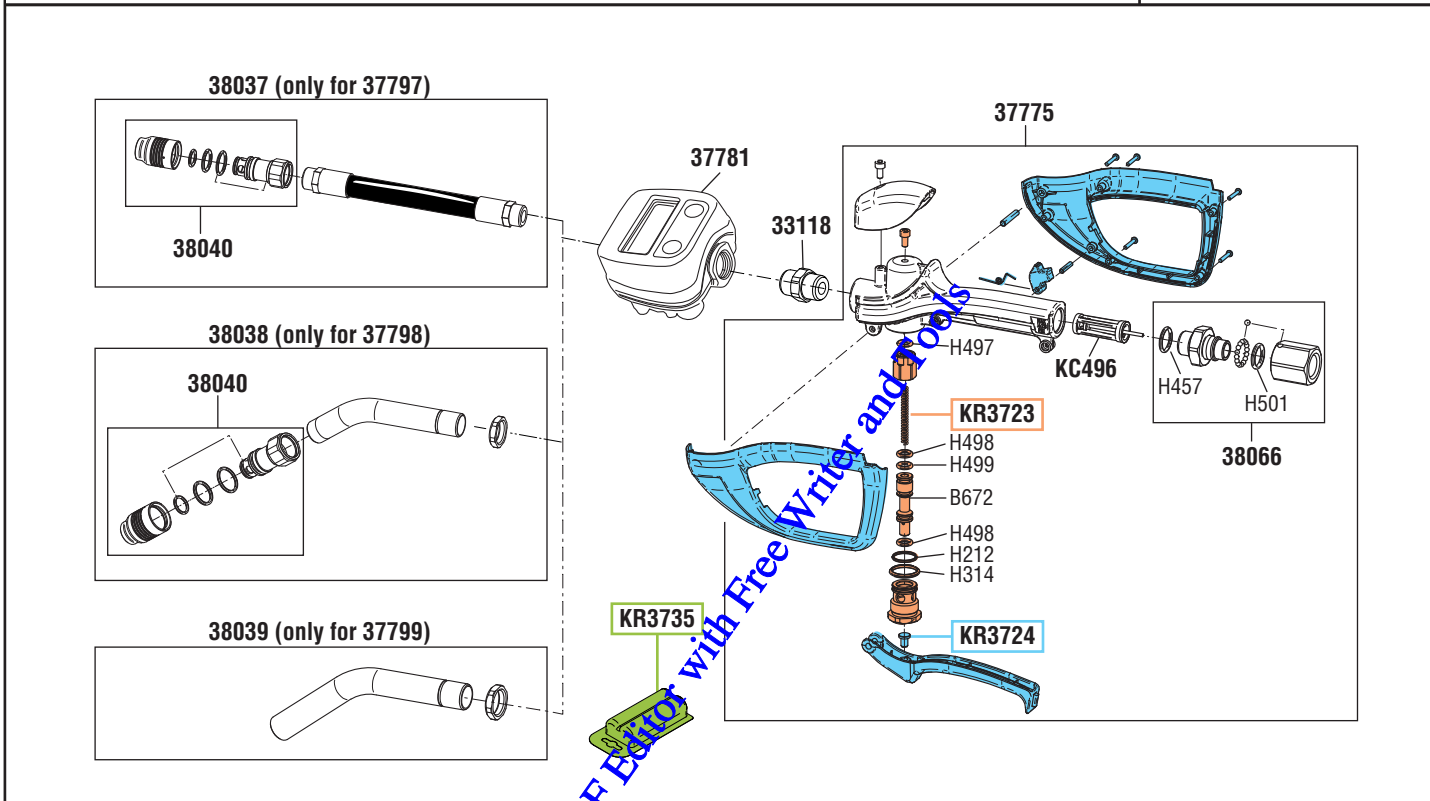

tutti i diritti riservati - all rights reserved

GUIDA RICAMBI - SPARE PARTS GUIDE

KIT RICAMBI
OGNI KIT SOTTO RIPORTATO COMPRENDE I RICAMBI EVIDENZIATI CON LO STESSO COLORE E LE RELATIVE GUARNIZIONI. QUESTI RICAMBI NON SONO FORNIBILI SEPARATAMENTE TRANNE QUELLI CODIFICATI.

SPARE PARTS KITS
EACH KIT SHOWN WITH THE SAME COLOR INCLUDES ALSO THE GASKETS. THE SPARE PARTS INCLUDED IN THE KIT CAN'T BE SUPPLIED SEPARATELY EXCEPT THOSE SHOWN WITH A PROPER CODE.

CODICE CODE	DESCRIZIONE DESCRIPTION	Q.TÀ QTY
KR3723	VALVOLA PISTOLA 1/2" OIL GUN VALVE 1/2"	1
KR3724	LEVA E PULSANTE PISTOLA OLIO OIL GUN LEVER AND LOCKING BUTTON	1
KR3735	KIT 2 BATTERIE MINISTILO "AAA" 1,5V AAA 1.5 V PENLIGHT BATTERY KITS	1

ELENCO RICAMBI FORNIBILI SINGOLARMENTE
LIST OF SPARE PARTS WHICH CAN BE SUPPLIED SEPARATELY

CODICE CODE	DESCRIZIONE DESCRIPTION	Q.TÀ QTY
33118	NIPPLE M 1/2" G - M 3/4" G NIPPLE M 1/2" G - M 3/4" G	1
37775	IMPUGNATURA IN LEGA DI ALLUMINIO GRIP IN ALUMINIUM ALLOY	1
37781	CONTALITRI DIGITALE "RAASM" DIGITAL OIL METER "RAASM"	1
38037	TERMINALE FLESSIBILE (Art. 37797) FLEXIBLE TERMINAL (Art. 37797)	1
38038	TERMINALE RIGIDO (Art. 37798) RIGID TERMINAL (Art. 37798)	1
38039	TERMINALE ALTA PORTATA (Art. 37799) HIGH DELIVERY RIGID TERMINAL (Art.37799)	1
38040	UGELLO SALVAGOCCE SEMIAUTOMATICO SEMI-AUTOMATIC DRIP-CATCHER NOZZLE	1
38066	SNODO GIREVOLE SWIVEL JOINT	1
B1412	NIPPLE M 1/2" G - F 3/4" G NIPPLE M 1/2" G - F 3/4" G	1
KC496	FILTRO PISTOLA 1/2" FILTER GUN 1/2"	1

Art. KR3760 KIT GUARNIZIONI COMPLETO
COMPOSTO DALLE GUARNIZIONI SOTTO ELENCAE
JOINTS GASKETS LIST
INCLUDING ALL THE GASKETS SHOWN HERE UNDER

CODICE CODE	DESCRIZIONE DESCRIPTION	Q.TÀ QTY
B672	SPILLO VALVOLA VALVE PIN	1
H212	O-RING 2075 "VITON" O-RING 2075 "VITON"	1
H314	O-RING 128 "VITON" O-RING 128 "VITON"	1
H457	O-RING 123 "VITON" O-RING 123 "VITON"	1
H497	O-RING 3030 "VITON" O-RING 3030 "VITON"	1
H498	O-RING 109 "VITON" O-RING 109 "VITON"	2
H501	O-RING "VITON" O-RING "VITON"	1
H499	O-RING 109 "VITON 90SH" O-RING 109 "VITON 90SH"	1
H502	O-RING 3056 "VITON" O-RING 3056 "VITON"	1
KC496	FILTRO PISTOLA 1/2" FILTER GUN 1/2"	1

Art. KS3788 SET RICAMBI CONSIGLIATI
AI PUNTI VENDITA E ASSISTENZA.
COMPOSTO DAI RICAMBI SOTTO ELENCAE
SPARE PARTS KIT ADVISED
TO THE REPAIR CENTERS. THIS KIT INCLUDES
ALL THE SPARE PARTS SHOWN HERE UNDER

CODICE CODE	DESCRIZIONE DESCRIPTION	Q.TÀ QTY
KR3723	VALVOLA PISTOLA OIL GUN VALVE	1
KR3760	KIT GUARNIZIONI COMPLETO COMPLETE GASKETS KIT	1



Art. 38020 - Art. 38021 - Art. 38022 - Art. 33121

VISTA ESPLOSA - EXPLODED VIEW

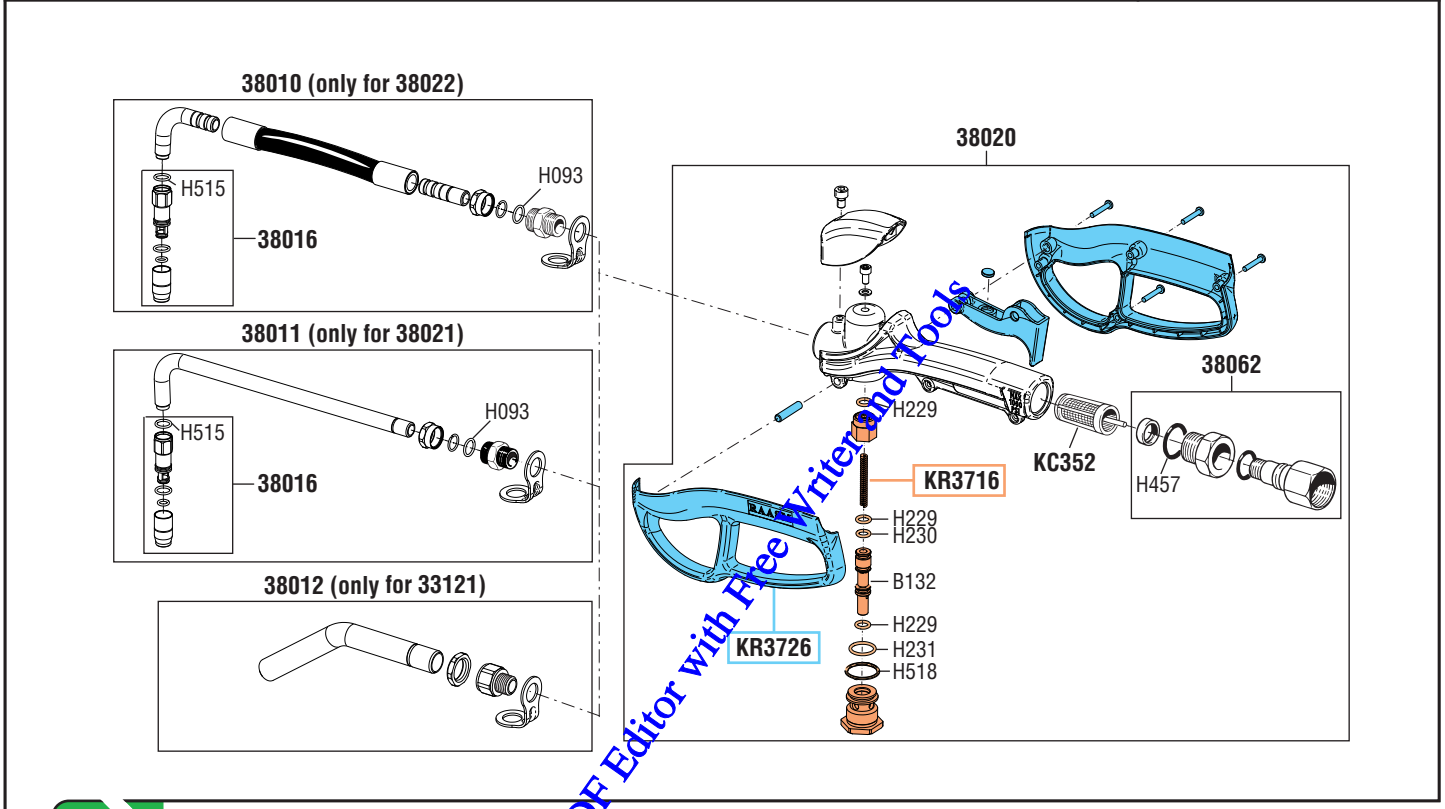
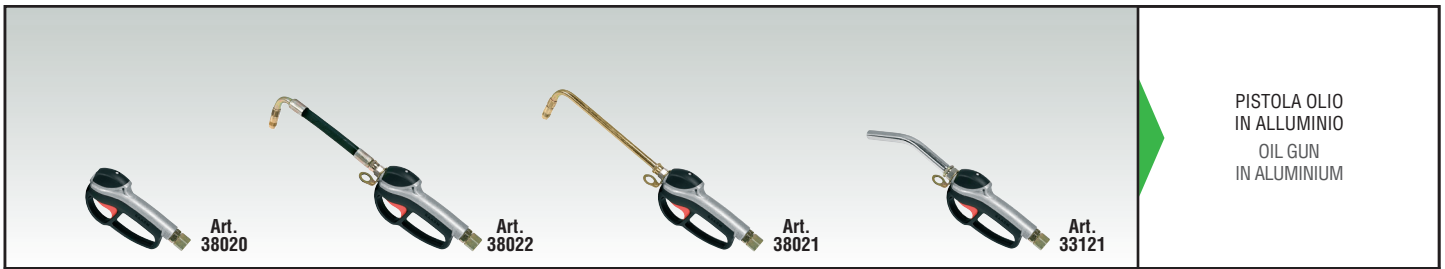

tutti i diritti riservati - all rights reserved

GUIDA RICAMBI - SPARE PARTS GUIDE

KIT RICAMBI
OGNI KIT SOTTO RIPORTATO COMPRENDE I RICAMBI EVIDENZIATI CON LO STESSO COLORE E LE RELATIVE GUARNIZIONI. QUESTI RICAMBI NON SONO FORNIBILI SEPARATAMENTE TRANNE QUELLI CODIFICATI.

SPARE PARTS KITS
EACH KIT SHOWN WITH THE SAME COLOR INCLUDES ALSO THE GASKETS. THE SPARE PARTS INCLUDED IN THE KIT CAN'T BE SUPPLIED SEPARATELY EXCEPT THOSE SHOWN WITH A PROPER CODE.

CODICE CODE	DESCRIZIONE DESCRIPTION	Q.TÀ QTY
KR3716	VALVOLA PISTOLA 3/8" OIL GUN VALVE 3/8"	1
KR3726	LEVA E PULSANTE PISTOLA OLIO OIL GUN LEVER AND LOCKING BUTTON	1

ELENCO RICAMBI FORNIBILI SINGOLARMENTE
LIST OF SPARE PARTS WHICH CAN BE SUPPLIED SEPARATELY

CODICE CODE	DESCRIZIONE DESCRIPTION	Q.TÀ QTY
38010	TERMINALE FLESSIBILE (Art. 38022) FLEXIBLE TERMINAL (Art. 38022)	1
38011	TERMINALE RIGIDO (Art. 38021) RIGID TERMINAL (Art. 38021)	1
38012	TERMINALE ALTA PORTATA (Art. 33121) HIGH DELIVERY RIGID TERMINAL (Art. 33121)	1
38016	UGELLO SALVAGOCCE SEMIAUTOMATICO SEMIAUTOMATIC DRIP-CATCHER NOZZLE	1
38020	IMPUGNATURA IN LEGA DI ALLUMINIO GRIP IN ALUMINIUM ALLOY	1
38062	SNODO GIREVOLE SWIVEL JOINT	1
KC352	FILTRO PISTOLA 3/8" FILTER GUN 3/8"	1

Art. KR3753 KIT GUARNIZIONI COMPLETO
COMPOSTO DALLE GUARNIZIONI SOTTO ELENCAE JOINTS GASKETS LIST INCLUDING ALL THE GASKETS SHOWN HERE UNDER

CODICE CODE	DESCRIZIONE DESCRIPTION	Q.TÀ QTY
B132	SPILLO VALVOLA VALVE PIN	1
H229	O-RING 106 "VITON" O-RING 106 "VITON"	3
H093	O-RING 2050 "VITON" O-RING 2050 "VITON"	1
H230	O-RING 2025 "VITON 90SH" O-RING 2025 "VITON 90SH"	1
H231	O-RING 2056 "VITON" O-RING 2056 "VITON"	1
H457	O-RING 123 "VITON" O-RING 123 "VITON"	1
H515	O-RING 2043 "VITON" O-RING 2043 "VITON"	1
H518	O-RING 2068 "VITON" O-RING 2068 "VITON"	1
KC352	FILTRO PISTOLA 3/8" FILTER GUN 3/8"	1

Art. KS3783 SET RICAMBI CONSIGLIATI
AI PUNTI VENDITA E ASSISTENZA, COMPOSTO DAI RICAMBI SOTTO ELENCAE TO THE REPAIR CENTERS. THIS KIT INCLUDES ALL THE SPARE PARTS SHOWN HERE UNDER

SPARE PARTS KIT ADVISED

CODICE CODE	DESCRIZIONE DESCRIPTION	Q.TÀ QTY
KR3716	VALVOLA PISTOLA OIL GUN VALVE	1
KR3753	KIT GUARNIZIONI COMPLETO COMPLETE GASKETS KIT	1



Art. 38023 - Art. 38024 - Art. 38025 - Art. 33120

VISTA ESPLOSA - EXPLODED VIEW

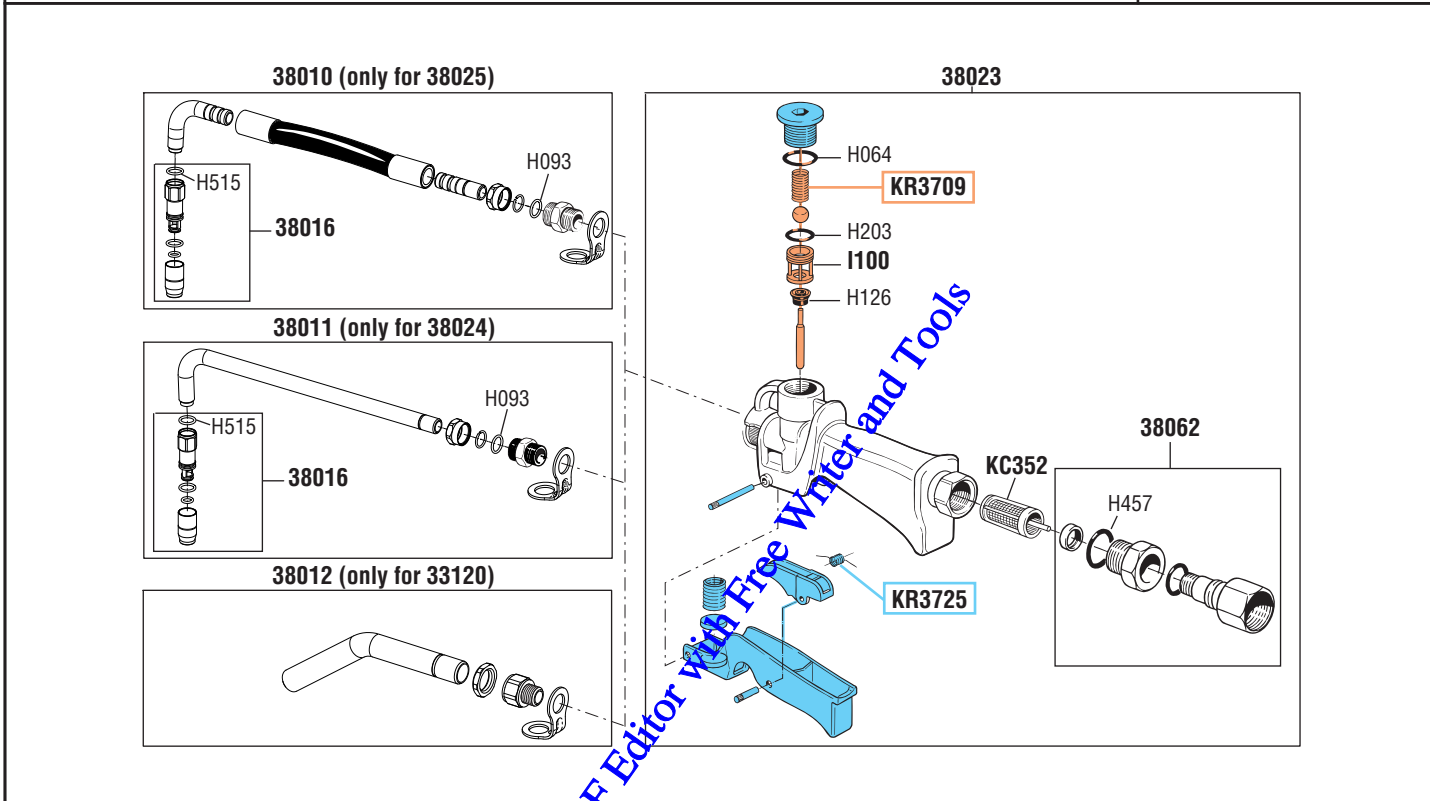
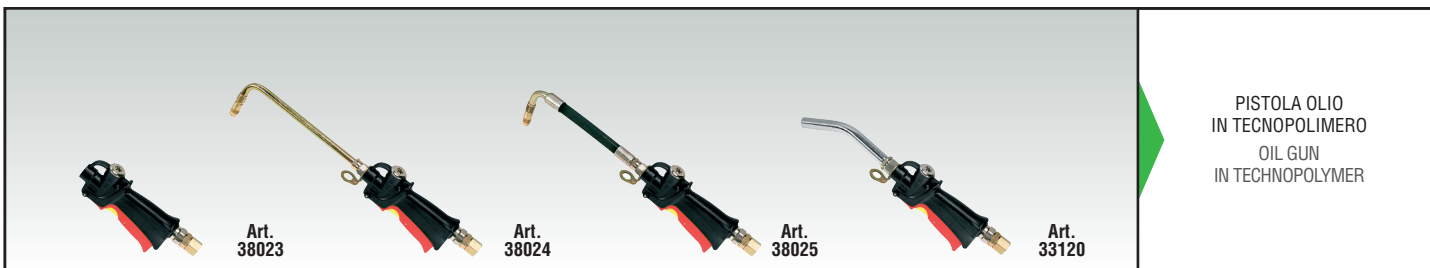

tutti i diritti riservati - all rights reserved

GUIDA RICAMBI - SPARE PARTS GUIDE

KIT RICAMBI
OGNI KIT SOTTO RIPORTATO COMPRENDE I RICAMBI EVIDENZIATI CON LO STESSO COLORE E LE RELATIVE GUARNIZIONI. QUESTI RICAMBI NON SONO FORNIBILI SEPARATAMENTE TRANNE QUELLI CODIFICATI.

SPARE PARTS KITS
EACH KIT SHOWN WITH THE SAME COLOR INCLUDES ALSO THE GASKETS. THE SPARE PARTS INCLUDED IN THE KIT CAN'T BE SUPPLIED SEPARATELY EXCEPT THOSE SHOWN WITH A PROPER CODE.

CODICE CODE	DESCRIZIONE DESCRIPTION	Q.TÀ QTY
KR3709	VALVOLA PISTOLA 3/8" OIL GUN VALVE 3/8"	1
KR3725	LEVA E PULSANTE PISTOLA OLIO OIL GUN LEVER AND LOCKING BUTTON	1

ELENCO RICAMBI FORNIBILI SINGOLARMENTE
LIST OF SPARE PARTS WHICH CAN BE SUPPLIED SEPARATELY

CODICE CODE	DESCRIZIONE DESCRIPTION	Q.TÀ QTY
38016	UGELLO SALVAGOCCE SEMIAUTOMATICO SEMIAUTOMATIC DRIP-CATCHER NOZZLE	1
38010	TERMINALE FLESSIBILE (Art. 38025) FLEXIBLE TERMINAL (Art. 38025)	1
38011	TERMINALE RIGIDO (Art. 38024) RIGID TERMINAL (Art. 38024)	1
38012	TERMINALE ALTA PORTATA (Art. 33120) HIGH DELIVERY RIGID TERMINAL (Art. 33120)	1
38023	IMPUGNATURA TECNOPOLIMERO GRIP IN TECHNO-POLYMER	1
38062	SNODO GIREVOLE SWIVEL JOINT	1
KC352	FILTRO PISTOLA 3/8" FILTER GUN 3/8"	1

Art. KR3752 KIT GUARNIZIONI COMPLETO
COMPOSTO DALLE GUARNIZIONI SOTTO ELENCAE JOINTS GASKETS LIST INCLUDING ALL THE GASKETS SHOWN HERE UNDER

CODICE CODE	DESCRIZIONE DESCRIPTION	Q.TÀ QTY
H064	O-RING 3043 O-RING 3043	1
H093	O-RING 2050 "VITON" O-RING 2050 "VITON"	1
H126	GUARNIZIONE ASTA INVERTITORE GASKET	1
H203	O-RING 2050 "90SH" O-RING 2050 "90SH"	1
H457	O-RING 123 "VITON" O-RING 123 "VITON"	1
H515	O-RING 2043 "VITON" O-RING 2043 "VITON"	1
I100	CASTELLETTO MOUNT	1
KC352	FILTRO PISTOLA 3/8" FILTER GUN 3/8"	1

Art. KS3782 SET RICAMBI CONSIGLIATI
AI PUNTI VENDITA E ASSISTENZA, COMPOSTO DAI RICAMBI SOTTO ELENCAE TO THE REPAIR CENTERS. THIS KIT INCLUDES ALL THE SPARE PARTS SHOWN HERE UNDER

SPARE PARTS KIT ADVISED

CODICE CODE	DESCRIZIONE DESCRIPTION	Q.TÀ QTY
KR3709	VALVOLA PISTOLA OIL GUN VALVE	1
KR3752	KIT GUARNIZIONI COMPLETO COMPLETE GASKETS KIT	1



Art. 38097



VISTA ESPLOSA - EXPLODED VIEW

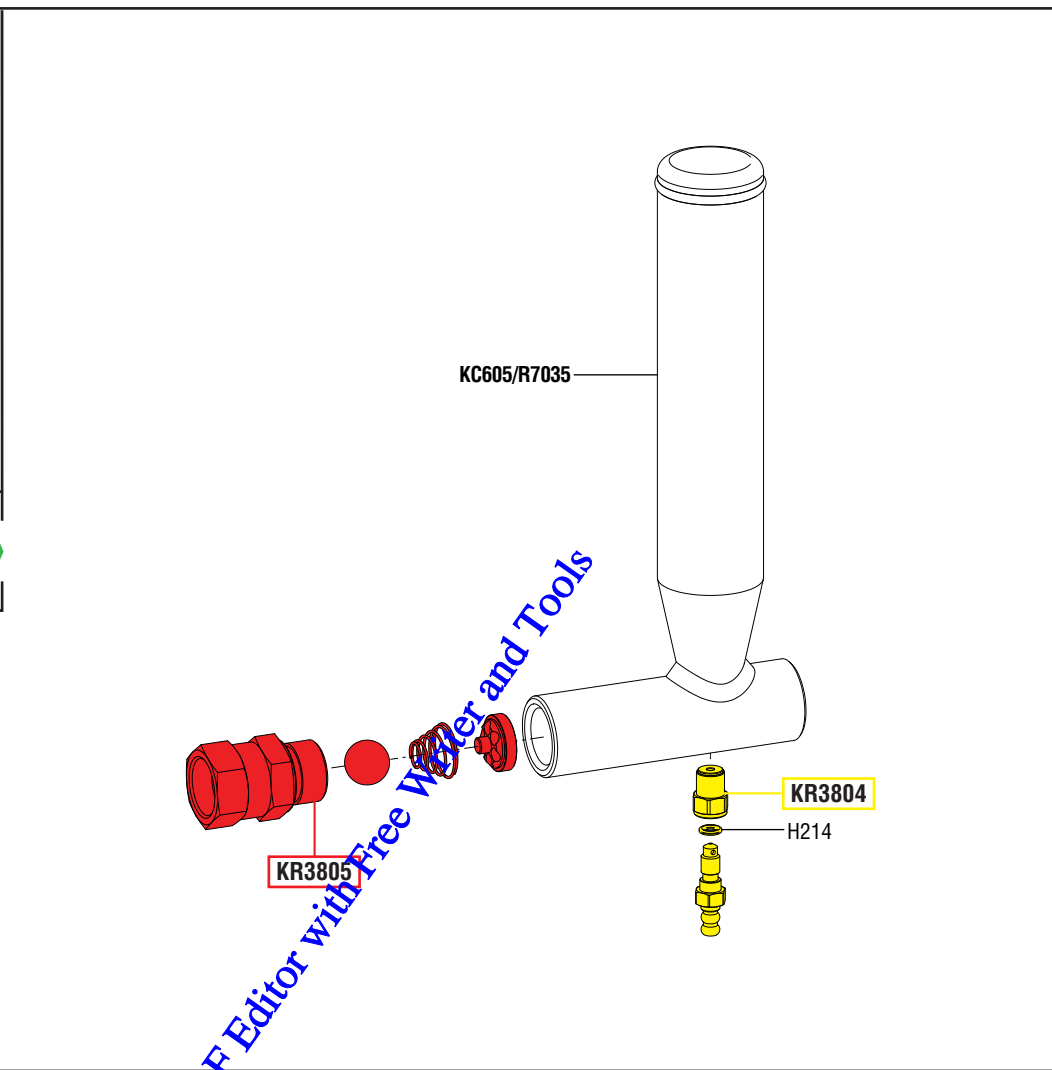

tutti i diritti riservati - all rights reserved

GUIDA RICAMBI - SPARE PARTS GUIDE

KIT RICAMBI
OGNI KIT SOTTO RIPORTATO COMPRENDE I RICAMBI EVIDENZIATI CON LO STESSO COLORE E LE RELATIVE GUARNIZIONI. QUESTI RICAMBI NON SONO FORNIBILI SEPARATAMENTE TRAMIE QUELLI CODIFICATI.

SPARE PARTS KITS
EACH KIT SHOWN WITH THE SAME COLOR INCLUDES ALSO THE GASKETS. THE SPARE PARTS INCLUDED IN THE KIT CAN'T BE SUPPLIED SEPARATELY EXCEPT THOSE SHOWN WITH A PROPER CODE.

CODICE CODE	DESCRIZIONE DESCRIPTION	Q.TÀ QTY
KR3804	VALVOLA DI SPURGO DRAIN VALVE	1
KR3805	VALVOLA UNIDIREZIONALE UNIDIRECTIONAL VALVE	1

ELENCO RICAMBI FORNIBILI SINGOLARMENTE
LIST OF SPARE PARTS WHICH CAN BE SUPPLIED SEPARATELY

CODICE CODE	DESCRIZIONE DESCRIPTION	Q.TÀ QTY
H214	O-RING 2025 "VITON" O-RING 2025 "VITON"	1
KC605/R7035	CORPO POLMONE REGOLATORE DI FLUSSO 3/4"G FLOW REGULATOR BODY CHAMBER 3/4"	1



Art. 38098



VISTA ESPLOSA - EXPLODED VIEW

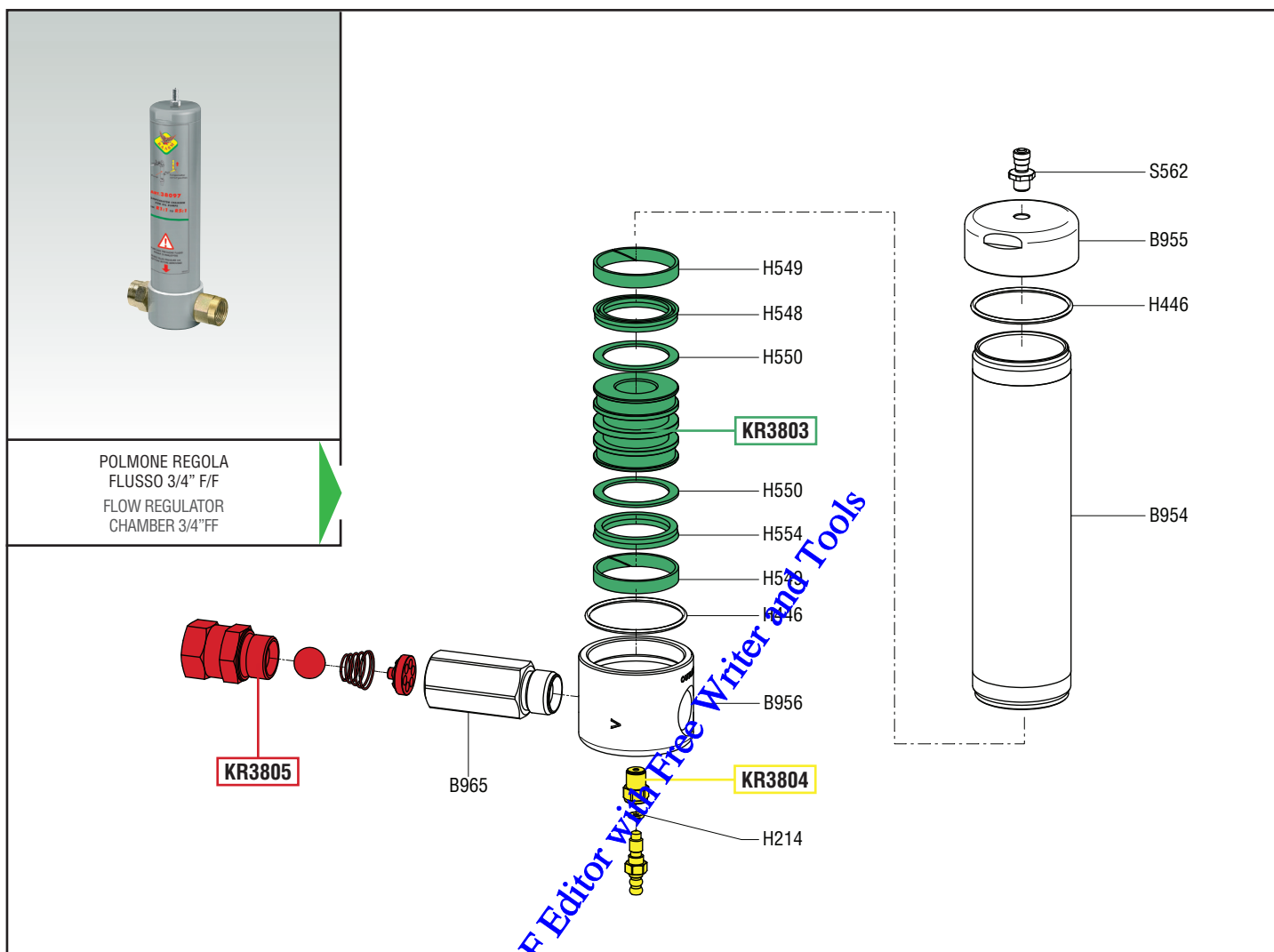

tutti i diritti riservati - all rights reserved

GUIDA RICAMBI - SPARE PARTS GUIDE

KIT RICAMBI
 OGNI KIT SOTTO RIPORTATO COMPRENDE I RICAMBI EVIDENZIATI CON LO STESSO COLORE E LE RELATIVE GUARNIZIONI. QUESTI RICAMBI NON SONO FORNIBILI SEPARATAMENTE TRAMIE QUELLI CODIFICATI.

SPARE PARTS KITS
 EACH KIT SHOWN WITH THE SAME COLOR INCLUDES ALSO THE GASKETS. THE SPARE PARTS INCLUDED IN THE KIT CAN'T BE SUPPLIED SEPARATELY EXCEPT THOSE SHOWN WITH A PROPER CODE.

CODICE CODE	DESCRIZIONE DESCRIPTION	Q.TÀ QTY
KR3803	PISTONE POLMONE DI COMPENSAZIONE PISTON CHAMBER	1
KR3804	VALVOLA DI SPURGO DRAIN VALVE	1
KR3805	VALVOLA UNIDIREZIONALE UNIDIRECTIONAL VALVE	1

ELENCO RICAMBI FORNIBILI SINGOLARMENTE
 LIST OF SPARE PARTS WHICH CAN BE SUPPLIED SEPARATELY

CODICE CODE	DESCRIZIONE DESCRIPTION	Q.TÀ QTY
B954	TUBO POLMONE CHAMBER HOSE	1
B955	TAPPO SUPERIORE UPPER PLUG	1
B956	TAPPO INFERIORE LOWER PLUG	1
B965	PROLUNGA PER POLMONE CHAMBER EXTENSION	1
H214	O-RING 2025 "VITON" O-RING 2025 "VITON"	1
H446	O-RING 3225 "VITON" O-RING 3225 "VITON"	2
H548	GUARNIZIONE GASKET	1
H549	FASCIA DI GUIDA GASKET	2
H550	ANELLO ANTIESTRUSIONE O-RING	2
H554	GUARNIZIONE GASKETS	1
S562	VALVOLA PRECARICA PRECHARGING VALVE	1



Art. 39304



VISTA ESPLOSA - EXPLODED VIEW

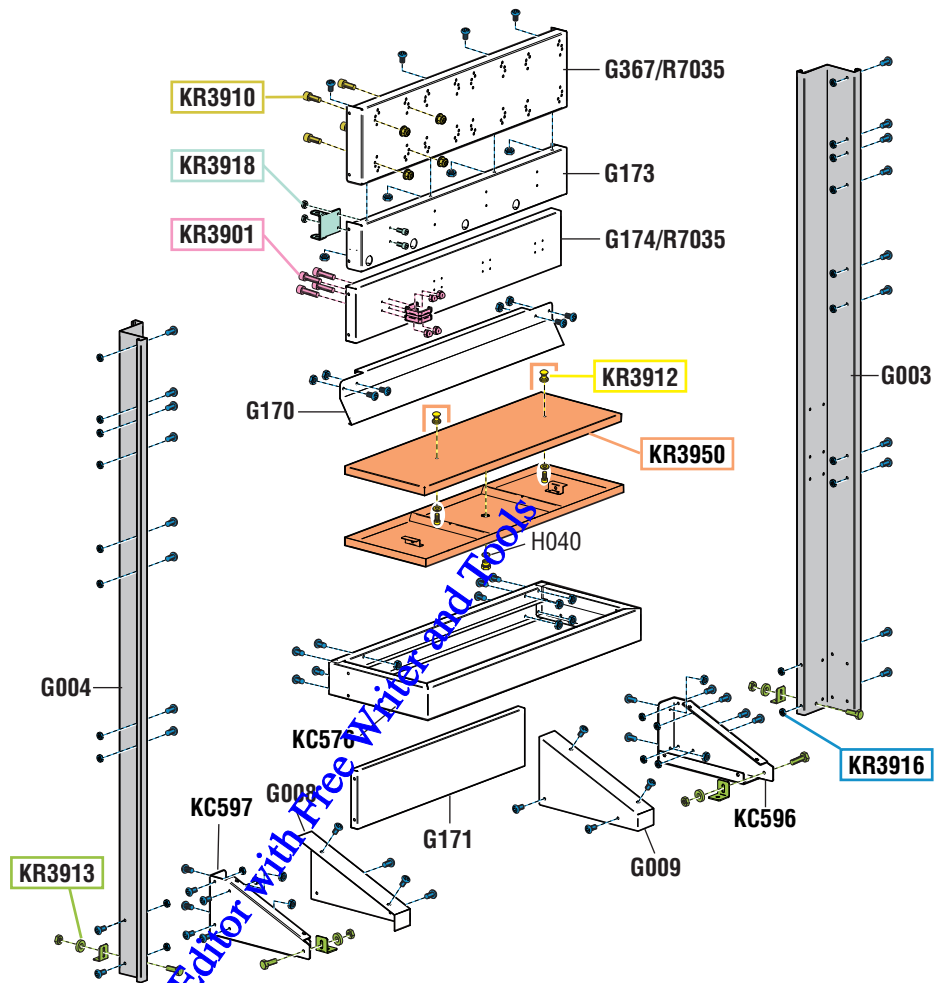

GUIDA RICAMBI - SPARE PARTS GUIDE

KIT RICAMBI

OGNI KIT SOTTO RIPORTATO COMPRENDE I RICAMBI EVIDENZIATI CON LO STESSO COLORE E LE RELATIVE GUARNIZIONI. QUESTI RICAMBI NON SONO FORNIBILI SEPARATAMENTE TRanne QUELLI CODIFICATI.

SPARE PARTS KITS

EACH KIT SHOWN WITH THE SAME COLOR INCLUDES ALSO THE GASKETS. THE SPARE PARTS INCLUDED IN THE KIT CAN'T BE SUPPLIED SEPARATELY EXCEPT THOSE SHOWN WITH A PROPER CODE.

CODICE CODE	DESCRIZIONE DESCRIPTION	Q.TÀ QTY
KR3901	GANCIO FERMA TUBO HOOK FOR HOSE	4
KR3910	VITERIA DI FISSAGGIO AVVOLGITUBO SCREWS FOR HOSE REEL FIXING	1
KR3912	TAPPI VASCHETTA - POMELLI E GRIGLIE PLUGS FOR BASIN AND KNOBS FOR NET	1
KR3913	STAFFE FISSAGGIO E VITERIA FIXING BRACKETS AND SCREWS	1
KR3916	VITERIA FISSAGGI ESTERNI SCREWS FOR LATERAL SUPPORT FIXING	1
KR3918	VITERIA FISSAGGIO VALVOLE SCREWS FOR VALVES FIXING	1
KR3950	VASCA DI RECUPERO DRIP-TRAY	1

ELENCO RICAMBI FORNIBILI SINGOLARMENTE

LIST OF SPARE PARTS WHICH CAN BE SUPPLIED SEPARATELY

CODICE CODE	DESCRIZIONE DESCRIPTION	Q.TÀ QTY
G003	PIANTONE DESTRO RIGHT BASE	1
G004	PIANTONE SX LEFT BASE	1
G008	CARTER COPERTURA GAMBA SINISTRA LEFT LEG COVER	1
G009	CARTER COPERTURA GAMBA DESTRA RIGHT LEG COVER	1
G170	TRAVERSO PARAOLIO OIL SHIELD BAR	1
G171	TRAVERSO INFERIORE LOWER BAR	1
G173	TRAVERSO FISSAGGIO VALVOLE BAR FOR VALVES FIXING	1
G174/R7035	PANNELLO INTERMEDIO INTERMEDIATE BAR	1
G367/R7035	PANNELLO PORTA AVVOLGITUBO BAR FOR HOSE REEL FIXING	1
H040	O-RING 123 O-RING 123	1
KC576	SOSTEGNO PER VASCA BASIN SUPPORT	1
KC596	GAMBA DESTRA RIGHT LEG	1
KC597	GAMBA SINISTRA LEFT LEG	1

tutti i diritti riservati - all rights reserved



Art. 39307



VISTA ESPLOSA - EXPLODED VIEW



COLONNA DI SERVIZIO FRONTALE
PER 6 AVVOLGITUBO
MULTIPLE SUPPORT FRONTAL
FOR 6 HOSEREEL

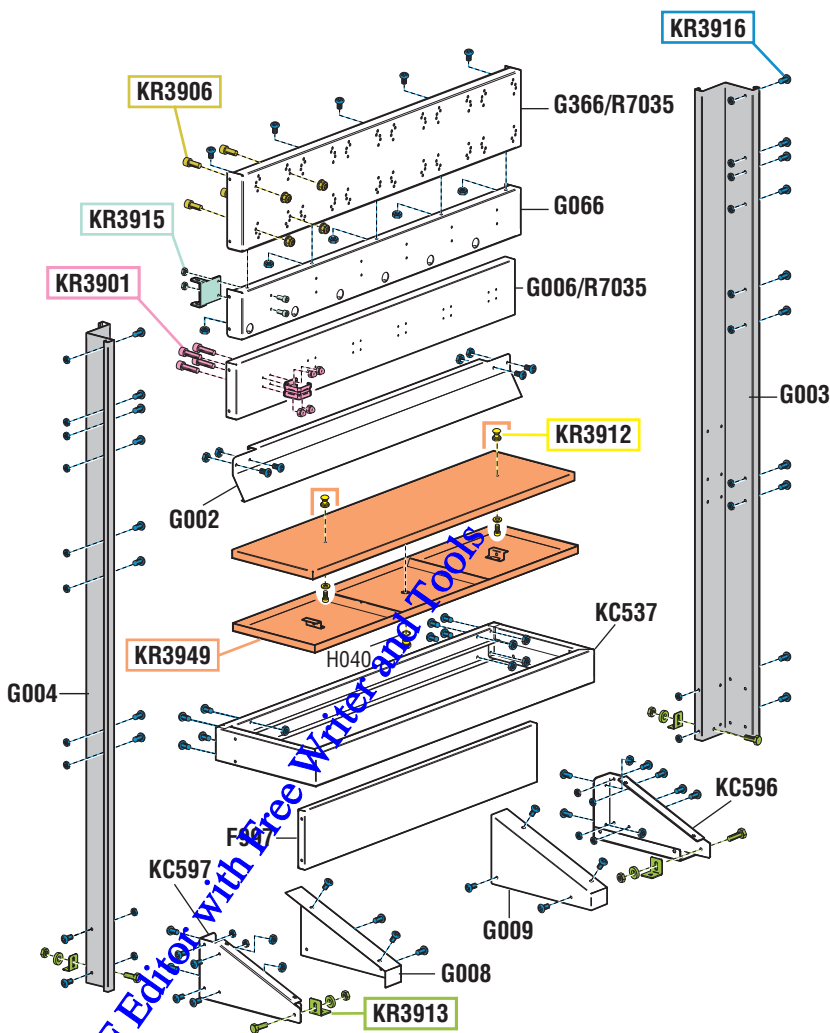

GUIDA RICAMBI - SPARE PARTS GUIDE

KIT RICAMBI

OGNI KIT SOTTO RIPORTATO COMPRENDE I RICAMBI EVIDENZIATI CON LO STESSO COLORE E LE RELATIVE GUARNIZIONI. QUESTI RICAMBI NON SONO FORNIBILI SEPARATAMENTE TRAMIE QUELLI CODIFICATI.

SPARE PARTS KITS

EACH KIT SHOWN WITH THE SAME COLOR INCLUDES ALSO THE GASKETS. THE SPARE PARTS INCLUDED IN THE KIT CAN'T BE SUPPLIED SEPARATELY EXCEPT THOSE SHOWN WITH A PROPER CODE.

CODICE CODE	DESCRIZIONE DESCRIPTION	Q.TÀ QTY
KR3901	GANCIO FERMA TUBO HOOK FOR HOSE	6
KR3906	VITERIA DI FISSAGGIO AVVOLGITUBO SCREWS FOR HOSEREEL FIXING	1
KR3912	TAPPI VASCHETTA - POMELLI E GRIGLIE PLUGS FOR BASIN AND KNOBS FOR NET	1
KR3913	STAFFE FISSAGGIO E VITERIA FIXING BRACKETS AND SCREWS	1
KR3915	VITERIA DI FISSAGGIO VALVOLE SCREWS FOR VALVES	1
KR3916	VITERIA FISSAGGI ESTERNI SCREWS FOR LATERAL SUPPORT FIXING	1
KR3949	VASCA DI RECUPERO DRIP-TRAY	1

ELENCO RICAMBI FORNIBILI SINGOLARMENTE

LIST OF SPARE PARTS WHICH CAN BE SUPPLIED SEPARATELY

CODICE CODE	DESCRIZIONE DESCRIPTION	Q.TÀ QTY
F997	TRAVERSO INFERIORE LOW BAR	1
G002	TRAVERSO PARAOLIO OIL SHIELD BAR	1
G003	PIANTONE DESTRO RIGHT BASE	1
G004	PIANTONE SINISTRO LEFT BASE	1
G006/R7035	PANNELLO INTERMEDIO INTERMEDIATE BAR	1
G008	CARTER COPERTURA GAMBA SINISTRA LEFT LEG COVER	1
G009	CARTER COPERTURA GAMBA DESTRA RIGHT LEG COVER	1
G066	TRAVERSO FISSAGGIO VALVOLE BAR FOR VALVES FIXING	1
G366/R7035	PANNELLO PORTA AVVOLGITUBO BAR FOR HOSEREEL FIXING	1
H040	O-RING 123 O-RING 123	1
KC537	SOSTEGNO PER VASCA BASIN SUPPORT	1
KC596	GAMBA DESTRA RIGHT LEG	1
KC597	GAMBA SINISTRA LEFT LEG	1

tutti i diritti riservati - all rights reserved



Art. 39314



VISTA ESPLOSA - EXPLODED VIEW

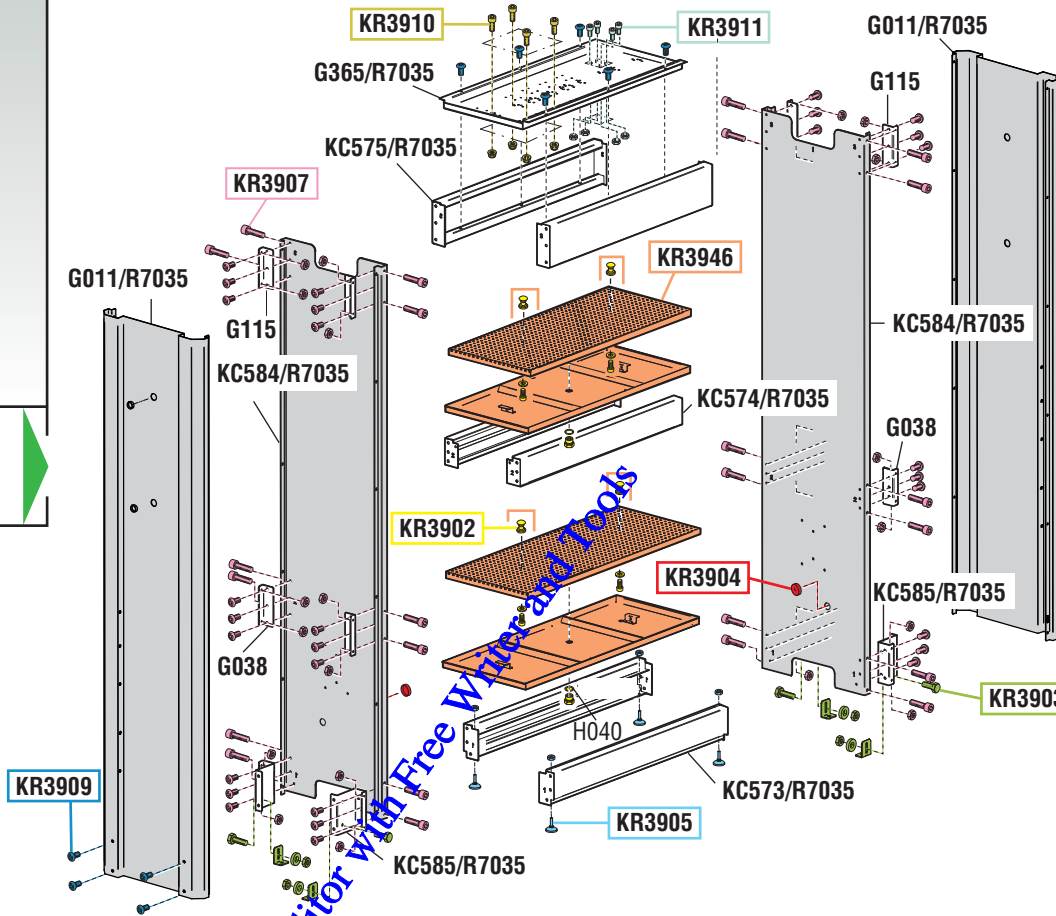

tutti i diritti riservati - all rights reserved

GUIDA RICAMBI - SPARE PARTS GUIDE

KIT RICAMBI
OGNI KIT SOTTO RIPORTATO COMPRENDE I RICAMBI EVIDENZIATI CON LO STESSO COLORE E LE RELATIVE GUARNIZIONI. QUESTI RICAMBI NON SONO FORNIBILI SEPARATAMENTE TRAMIE QUELLI CODIFICATI.

SPARE PARTS KITS
EACH KIT SHOWN WITH THE SAME COLOR INCLUDES ALSO THE GASKETS. THE SPARE PARTS INCLUDED IN THE KIT CAN'T BE SUPPLIED SEPARATELY EXCEPT THOSE SHOWN WITH A PROPER CODE.

CODICE CODE	DESCRIZIONE DESCRIPTION	Q.TÀ QTY
KR3902	TAPPI VASCHETTA - POMELLI E GRIGLIE PLUGS FOR BASIN AND KNOBS FOR NET	1
KR3903	STAFFETTE FISSAGGIO E VITERIA FIXING BRACKET AND SCREWS	1
KR3904	TAPPI COPRI FORO PLUGS FOR HOLES	1
KR3905	PIEDINI DI FISSAGGIO FIXING FEET	1
KR3907	VITERIA FISSAGGIO RINFORZI - TAPPI SCREWS FOR BRACKETS AND PLUGS	1
KR3909	VITERIA FISSAGGI ESTERNI SCREWS FOR LATERAL SUPPORT FIXING	1
KR3910	VITERIA DI FISSAGGIO AVVOLGITUBO SCREWS FOR HOSE REEL FIXING	1
KR3911	VITERIA FISSAGGIO VALVOLE SCREWS FOR VALVES FIXING	1
KR3946	VASCA DI RECUPERO DRIP-TRAY	2

ELENCO RICAMBI FORNIBILI SINGOLARMENTE
LIST OF SPARE PARTS WHICH CAN BE SUPPLIED SEPARATELY

CODICE CODE	DESCRIZIONE DESCRIPTION	Q.TÀ QTY
G011/R7035	SPALLA ESTERNA EXTERNAL SHOULDER	2
G038	STAFFA CENTRALE DI RINFORZO CENTRAL BRACKET	4
G115	STAFFA DI RINFORZO SUPERIORE UPPER BRACKET	4
G365/R7035	STAFFA FISSAGGIO AVVOLGITUBO FIXING BRACKET FOR HOSE REEL	1
H040	O-RING 123 O-RING 123	2
KC573/R7035	PROFILO BASE BASE	2
KC574/R7035	PROFILO CENTRALE CENTRAL BAR	2
KC575/R7035	PROFILO SUPERIORE UPPER BAR	2
KC584/R7035	SPALLA INTERNA INTERNAL SHOULDER	2
KC585/R7035	STAFFA DI RINFORZO INFERIORE LOWER BRACKET	4



Art. 39317

VISTA ESPLOSA - EXPLODED VIEW

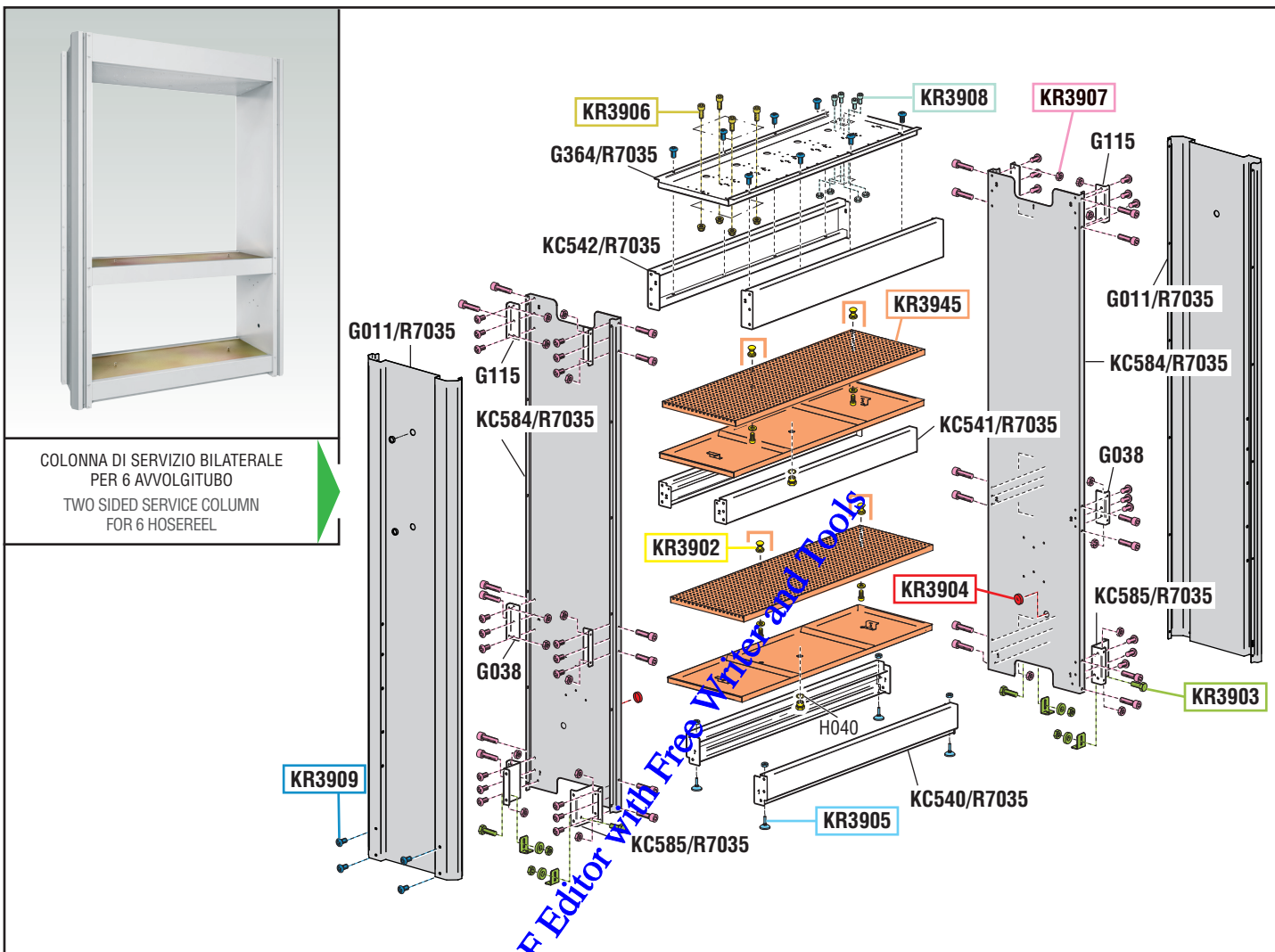

COLONNA DI SERVIZIO BILATERALE PER 6 AVVOLGITUBO
TWO SIDED SERVICE COLUMN FOR 6 HOSE REEL

tutti i diritti riservati - all rights reserved

GUIDA RICAMBI - SPARE PARTS GUIDE

KIT RICAMBI

OGNI KIT SOTTO RIPORTATO COMPRENDE I RICAMBI EVIDENZIATI CON LO STESSO COLORE E LE RELATIVE GUARNIZIONI. QUESTI RICAMBI NON SONO FORNIBILI SEPARATAMENTE TRAMITE QUELLI CODIFICATI.

SPARE PARTS KITS

EACH KIT SHOWN WITH THE SAME COLOR INCLUDES ALSO THE GASKETS. THE SPARE PARTS INCLUDED IN THE KIT CAN'T BE SUPPLIED SEPARATELY EXCEPT THOSE SHOWN WITH A PROPER CODE.

CODICE CODE	DESCRIZIONE DESCRIPTION	Q.TÀ QTY
KR3902	TAPPI VASCHETTA - POMELLI E GRIGLIE PLUGS FOR BASIN AND KNOBS FOR NET	1
KR3903	STAFFETTE FISSAGGIO E VITERIA FIXING BRACKET AND SCREWS	1
KR3904	TAPPI COPRI FORO PLUGS FOR HOLES	1
KR3905	PIEDINI DI FISSAGGIO FIXING FEET	1
KR3906	VITERIA DI FISSAGGIO AVVOLGITUBO SCREWS FOR HOSE REEL FIXING	1
KR3907	VITERIA FISSAGGIO RINFORZI - TAPPI SCREWS FOR BRACKETS AND PLUGS	1
KR3908	VITERIA FISSAGGIO VALVOLE SCREWS FOR VALVES FIXING	1
KR3909	VITERIA FISSAGGI ESTERNI SCREWS FOR LATERAL SUPPORT FIXING	1
KR3945	VASCA DI RECUPERO DRIP-TRAY	2

ELENCO RICAMBI FORNIBILI SINGOLARMENTE

LIST OF SPARE PARTS WHICH CAN BE SUPPLIED SEPARATELY

CODICE CODE	DESCRIZIONE DESCRIPTION	Q.TÀ QTY
G011/R7035	SPALLA ESTERNA EXTERNAL SHOULDER	2
G038	STAFFA CENTRALE DI RINFORZO CENTRAL BRACKET	4
G115	STAFFA DI RINFORZO SUPERIORE UPPER BRACKET	4
G364/R7035	STAFFA FISSAGGIO AVVOLGITUBO FIXING BRACKET FOR HOSE REEL	1
H040	O-RING 123 O-RING 123	2
KC540/R7035	PROFILO BASE BASE	2
KC541/R7035	PROFILO CENTRALE CENTRAL BAR	2
KC542/R7035	PROFILO SUPERIORE UPPER BAR	2
KC584/R7035	SPALLA INTERNA INTERNAL SHOULDER	2
KC585/R7035	STAFFA DI RINFORZO INFERIORE LOWER BRACKET	4



Art. 39320



VISTA ESPLOSA - EXPLODED VIEW

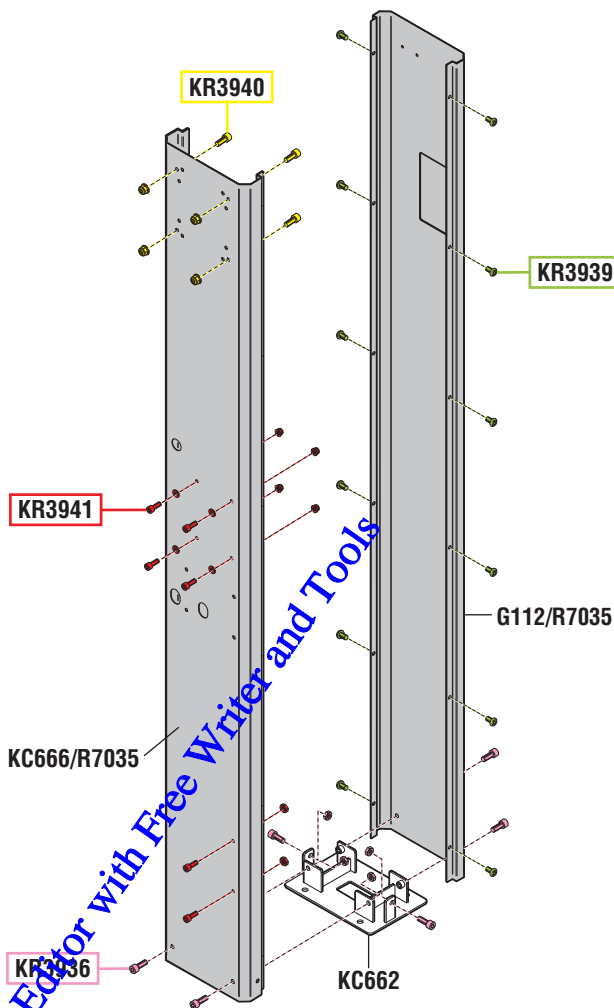
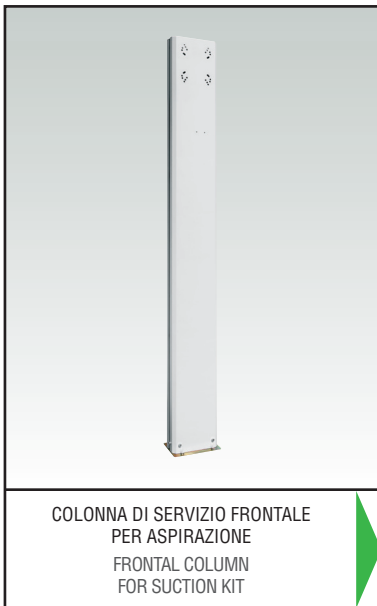

tutti i diritti riservati - all rights reserved

GUIDA RICAMBI - SPARE PARTS GUIDE

KIT RICAMBI
OGNI KIT SOTTO RIPORTATO COMPRENDE I RICAMBI EVIDENZIATI CON LO STESSO COLORE E LE RELATIVE GUARNIZIONI. QUESTI RICAMBI NON SONO FORNIBILI SEPARATAMENTE TRAMIE QUELLI CODIFICATI.

SPARE PARTS KITS
EACH KIT SHOWN WITH THE SAME COLOR INCLUDES ALSO THE GASKETS. THE SPARE PARTS INCLUDED IN THE KIT CAN'T BE SUPPLIED SEPARATELY EXCEPT THOSE SHOWN WITH A PROPER CODE.

CODICE CODE	DESCRIZIONE DESCRIPTION	Q.TÀ QTY
KR3936	VITERIA FISSAGGIO BASE SALDATA SCREWS FOR BASE FIXING	1
KR3939	VITERIA FISSAGGIO PROFILI SCREWS FOR BARS FIXING	1
KR3940	VITERIA FISSAGGIO AVVOLGITUBO SCREWS FOR HOSE REEL FIXING	1
KR3941	VITERIA FISSAGGIO STAFFA POMPA E PORTASONDE SCREWS FOR PUMP BRACKET AND PROBES CONTAINER	1

ELENCO RICAMBI FORNIBILI SINGOLARMENTE
LIST OF SPARE PARTS WHICH CAN BE SUPPLIED SEPARATELY

CODICE CODE	DESCRIZIONE DESCRIPTION	Q.TÀ QTY
G112/R7035	PROFILO ESTERNO COLONNA COLUMN EXTERNAL SIDE	1
KC662	BASE SALDATA ANCORAGGIO PAVIMENTO FLOOR BASE	1
KC666/R7035	PROFILO INTERNO COLONNA COLUMN INTERNAL SIDE	1



Art. 39321



VISTA ESPLOSA - EXPLODED VIEW

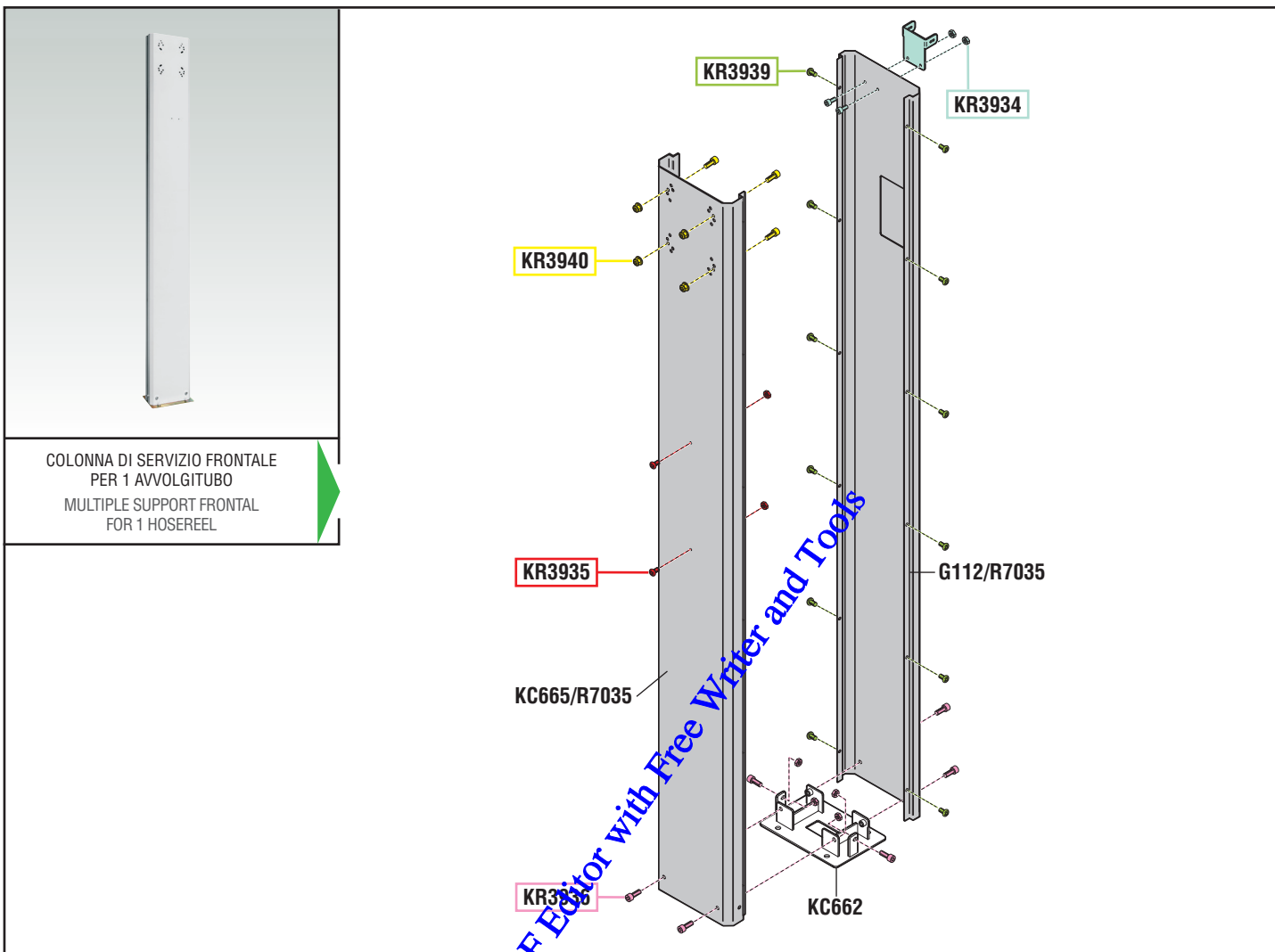

COLONNA DI SERVIZIO FRONTALE
PER 1 AVVOLGITUBO
MULTIPLE SUPPORT FRONTAL
FOR 1 HOSE REEL

GUIDA RICAMBI - SPARE PARTS GUIDE

KIT RICAMBI

OGNI KIT SOTTO RIPORTATO COMPRENDE I RICAMBI EVIDENZIATI CON LO STESSO COLORE E LE RELATIVE GUARNIZIONI. QUESTI RICAMBI NON SONO FORNIBILI SEPARATAMENTE TRAMITE QUELLI CODIFICATI.

SPARE PARTS KITS

EACH KIT SHOWN WITH THE SAME COLOR INCLUDES ALSO THE GASKETS. THE SPARE PARTS INCLUDED IN THE KIT CAN'T BE SUPPLIED SEPARATELY EXCEPT THOSE SHOWN WITH A PROPER CODE.

CODICE CODE	DESCRIZIONE DESCRIPTION	Q.TÀ QTY
KR3934	STAFFETTE FISSAGGIO VALVOLE E VITERIA BRACKETS FOR VALVES FIXING AND SCREWS	1
KR3935	VITERIA FISSAGGIO RACCOGLIGOCCE SCREWS FOR DRIP-TRAY FIXING	1
KR3936	VITERIA FISSAGGIO BASE SALDATA SCREWS FOR BASE FIXING	1
KR3939	VITERIA FISSAGGIO PROFILI SCREWS FOR BARS FIXING	1
KR3940	VITERIA FISSAGGIO AVVOLGITUBO SCREWS FOR HOSE REEL FIXING	1

ELENCO RICAMBI FORNIBILI SINGOLARMENTE

LIST OF SPARE PARTS WHICH CAN BE SUPPLIED SEPARATELY

CODICE CODE	DESCRIZIONE DESCRIPTION	Q.TÀ QTY
G112/R7035	PROFILO ESTERNO COLONNA COLUMN EXTERNAL SIDE	1
KC662	BASE SALDATA ANCORAGGIO PAVIMENTO FLOOR BASE	1
KC665/R7035	PROFILO INTERNO COLONNA COLUMN INTERNAL SIDE	1

tutti i diritti riservati - all rights reserved



Art. 39322



VISTA ESPLOSA - EXPLODED VIEW

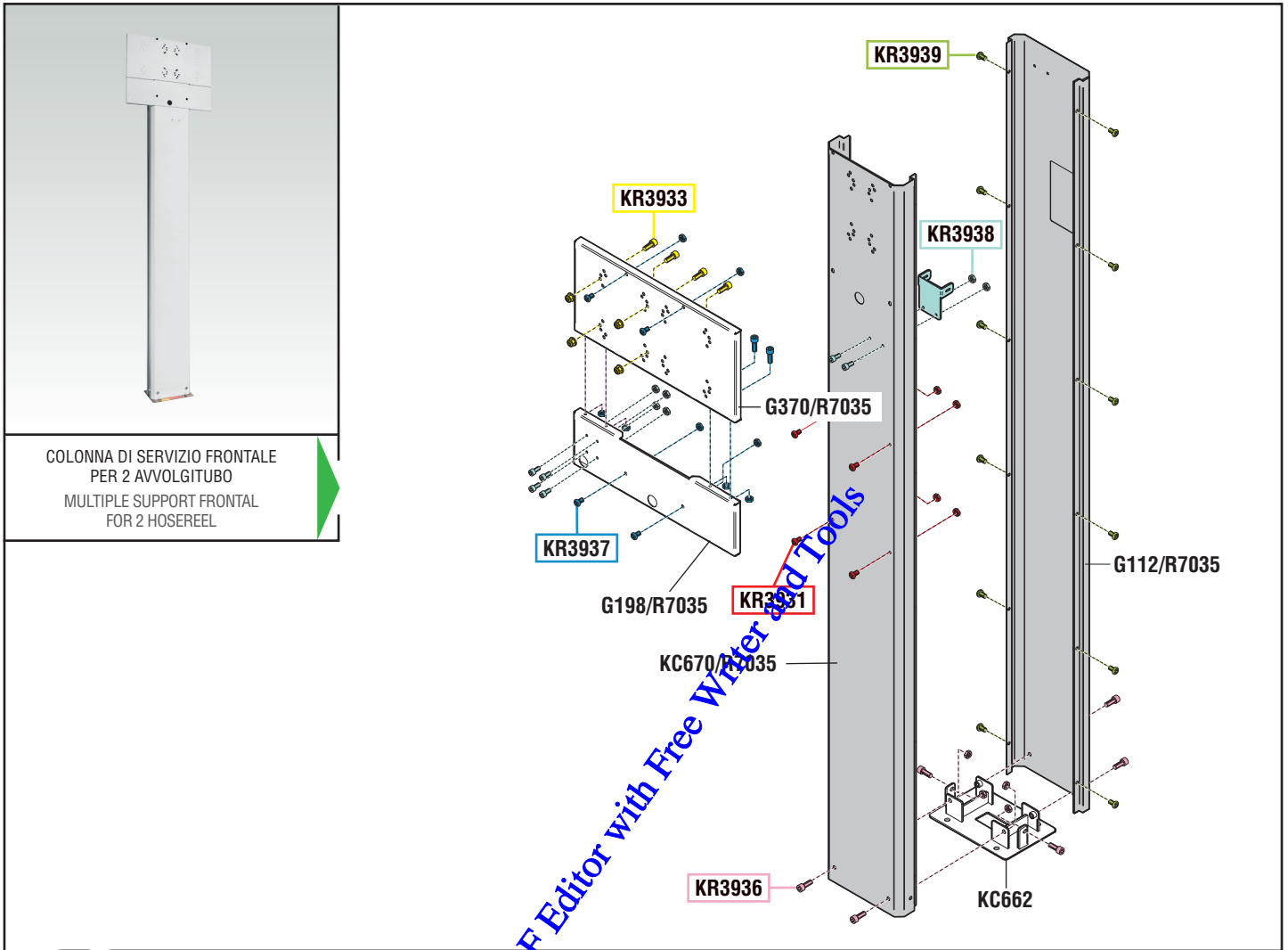

COLONNA DI SERVIZIO FRONTALE
PER 2 AVVOLGITUBO
MULTIPLE SUPPORT FRONTAL
FOR 2 HOSEREEL

GUIDA RICAMBI - SPARE PARTS GUIDE

KIT RICAMBI

OGNI KIT SOTTO RIPORTATO COMPRENDE I RICAMBI EVIDENZIATI CON LO STESSO COLORE E LE RELATIVE GUARNIZIONI. QUESTI RICAMBI NON SONO FORNIBILI SEPARATAMENTE TRanne QUELLI CODIFICATI.

SPARE PARTS KITS

EACH KIT SHOWN WITH THE SAME COLOR INCLUDES ALSO THE GASKETS. THE SPARE PARTS INCLUDED IN THE KIT CAN'T BE SUPPLIED SEPARATELY EXCEPT THOSE SHOWN WITH A PROPER CODE.

CODICE CODE	DESCRIZIONE DESCRIPTION	Q.TÀ QTY
KR3931	VITERIA FISSAGGIO SALVAGOCCE SCREWS FOR DRIP-TRAY FIXING	1
KR3933	VITERIA FISSAGGIO AVVOLGITUBO SCREWS FOR HOSEREEL FIXING	1
KR3936	VITERIA FISSAGGIO BASE SALDATA SCREWS FOR BASE FIXING	1
KR3937	VITERIA FISSAGGIO PANNELLI SCREWS FOR PANELS FIXING	1
KR3938	STAFFETTE FISSAGGIO VALVOLE E VITERIA BRACKETS FOR VALVES FIXING AND SCREWS	1
KR3939	VITERIA FISSAGGIO PROFILI SCREWS FOR BARS FIXING	1

ELENCO RICAMBI FORNIBILI SINGOLARMENTE

LIST OF SPARE PARTS WHICH CAN BE SUPPLIED SEPARATELY

CODICE CODE	DESCRIZIONE DESCRIPTION	Q.TÀ QTY
G112/R7035	PROFILO ESTERNO COLONNA COLUMN EXTERNAL SIDE	1
G198/R7035	PANNELLO PER VALVOLE VALVES PANEL	1
G370/R7035	PANNELLO PER 2 AVVOLGITUBO 2 HOSEREEL PANEL	1
KC662	BASE SALDATA ANCORAGGIO PAVIMENTO FLOOR BASE	1
KC670/R7035	PROFILO INTERNO COLONNA COLUMN INTERNAL SIDE	1

tutti i diritti riservati - all rights reserved



Art. 39323



VISTA ESPLOSA - EXPLODED VIEW

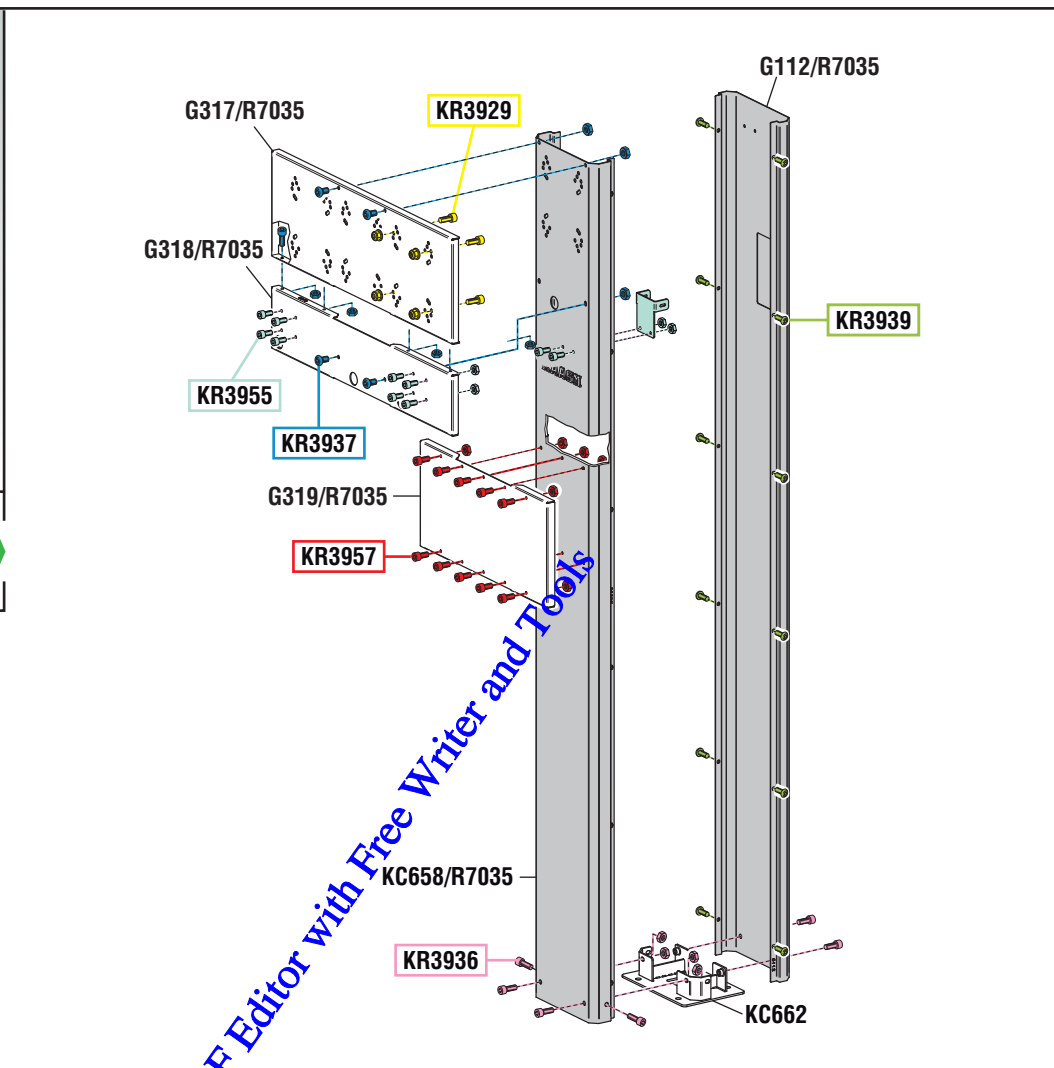
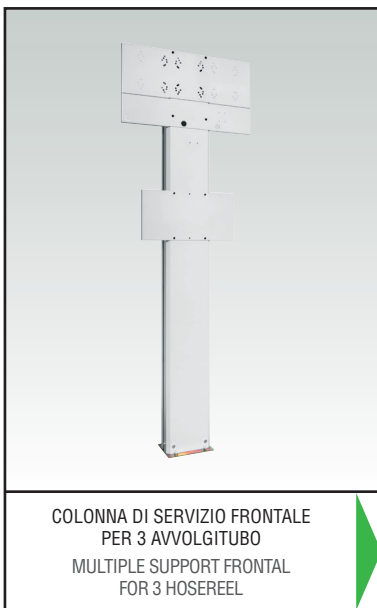

GUIDA RICAMBI - SPARE PARTS GUIDE

KIT RICAMBI
OGNI KIT SOTTO RIPORTATO COMPRENDE I RICAMBI EVIDENZIATI CON LO STESSO COLORE E LE RELATIVE GUARNIZIONI. QUESTI RICAMBI NON SONO FORNIBILI SEPARATAMENTE TRanne QUELLI CODIFICATI.

SPARE PARTS KITS
EACH KIT SHOWN WITH THE SAME COLOR INCLUDES ALSO THE GASKETS. THE SPARE PARTS INCLUDED IN THE KIT CAN'T BE SUPPLIED SEPARATELY EXCEPT THOSE SHOWN WITH A PROPER CODE.

CODICE CODE	DESCRIZIONE DESCRIPTION	Q.TÀ QTY
KR3929	VITERIA FISSAGGIO AVVOLGITUBO SCREWS FOR HOSE REEL FIXING	1
KR3936	VITERIA FISSAGGIO BASE SALDATA SCREWS FOR BASE FIXING	1
KR3937	VITERIA FISSAGGIO PANNELLI SCREWS FOR PANELS FIXING	1
KR3939	VITERIA FISSAGGIO PROFILI SCREWS FOR BARS FIXING	1
KR3955	VITERIA FISSAGGIO VALVOLE SCREWS FOR VALVES FIXING	1
KR3957	STAFFETTE FISSAGGIO SALVAGOCCE BRACKETS FOR DRIP-TRAY FIXING	1

ELENCO RICAMBI FORNIBILI SINGOLARMENTE
LIST OF SPARE PARTS WHICH CAN BE SUPPLIED SEPARATELY

CODICE CODE	DESCRIZIONE DESCRIPTION	Q.TÀ QTY
G112/R7035	PROFILO ESTERNO COLONNA COLUMN EXTERNAL SIDE	1
G317/R7035	PANNELLO PER 3 AVVOLGITUBO 3 HOSE REEL PANEL	1
G318/R7035	PANNELLO PER VALVOLE VALVES PANEL	1
G319/R7035	PANNELLO FISSAGGIO SALVAGOCCE DRIP-CATCHER PANEL FIXING	1
KC658/R7035	SPALLA PER COLONNA COLUMN SHOULDER	1
KC662	BASE SALDATA ANCORAGGIO PAVIMENTO FLOOR BASE	1

tutti i diritti riservati - all rights reserved



Art. 39324



VISTA ESPLOSA - EXPLODED VIEW

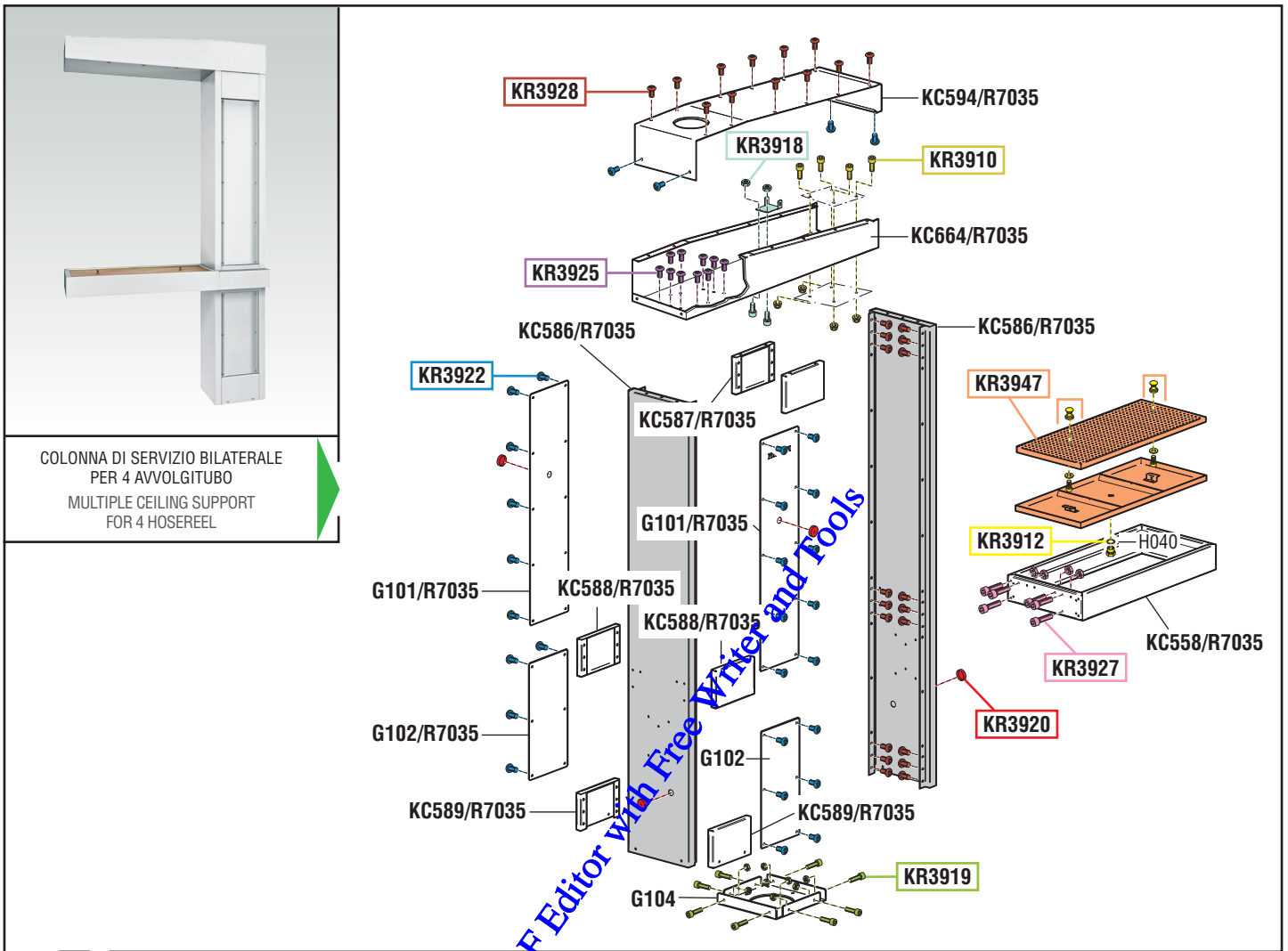

COLONNA DI SERVIZIO BILATERALE
PER 4 AVVOLGITUBO
MULTIPLE CEILING SUPPORT
FOR 4 HOSE REEL

GUIDA RICAMBI - SPARE PARTS GUIDE

KIT RICAMBI

OGNI KIT SOTTO RIPORTATO COMPRENDE I RICAMBI EVIDENZIATI CON LO STESSO COLORE E LE RELATIVE GUARNIZIONI. QUESTI RICAMBI NON SONO FORNIBILI SEPARATAMENTE TRanne QUELLI CODIFICATI.

SPARE PARTS KITS

EACH KIT SHOWN WITH THE SAME COLOR INCLUDES ALSO THE GASKETS. THE SPARE PARTS INCLUDED IN THE KIT CAN'T BE SUPPLIED SEPARATELY EXCEPT THOSE SHOWN WITH A PROPER CODE.

CODICE CODE	DESCRIZIONE DESCRIPTION	Q.TÀ QTY
KR3910	VITERIA DI FISSAGGIO AVVOLGITUBO SCREWS FOR HOSE REEL FIXING	1
KR3912	TAPPI VASCHETTA - POMELLI E GRIGLIE PLUGS FOR BASIN AND KNOBS FOR NET	1
KR3918	VITERIA FISSAGGIO VALVOLE SCREWS FOR VALVES FIXING	1
KR3919	VITERIA DI FISSAGGIO BASAMENTO SCREWS FOR BASE FIXING	1
KR3920	TAPPI COPRI FORO PLUGS FOR HOLES	1
KR3922	VITERIA DI FISSAGGIO SCATOLATI SCREWS FOR COVERS FIXING	1
KR3925	VITERIA FISSAGGIO PROFILO AVVOLGITUBO SCREWS FOR HOSE REEL FIXING BAR	1
KR3927	VITERIA PROFILO VASCA DI RACCOLTA SCREWS FOR BASIN	1
KR3928	VITERIA FISSAGGI ESTERNI SCREWS FOR LATERAL SUPPORT FIXING	1
KR3947	VASCA DI RECUPERO DRIP-TRAY	1

ELENCO RICAMBI FORNIBILI SINGOLARMENTE

LIST OF SPARE PARTS WHICH CAN BE SUPPLIED SEPARATELY

CODICE CODE	DESCRIZIONE DESCRIPTION	Q.TÀ QTY
G101/R7035	PANNELLO ISPEZIONALE ALTO HIGH COVER	2
G102	PANNELLO ISPEZIONALE BASSO LOW COVER	2
G104	BASAMENTO COLONNA COLUMN BASE	1
H040	O-RING 123 O-RING 123	1
KC558/R7035	PROFILO SALDATO PORTAVASCA BASIN SUPPORT	1
KC586/R7035	SPALLA PER COLONNA COLUMN SHOULDER	2
KC587/R7035	SCATOLATO SUPERIORE UPPER CARTER	2
KC588/R7035	SCATOLATO MEDIANO INTERMEDIATE CARTER	2
KC589/R7035	SCATOLATO BASSO LOWER CARTER	2
KC594/R7035	CARTER CHIUSURA PROFILO AVVOLGITUBO UPPER COVER	1
KC664/R7035	PROFILO ATTACCO AVVOLGITUBO BAR FOR HOSE REEL FIXING	1

tutti i diritti riservati - all rights reserved



Art. 39328



VISTA ESPLOSA - EXPLODED VIEW

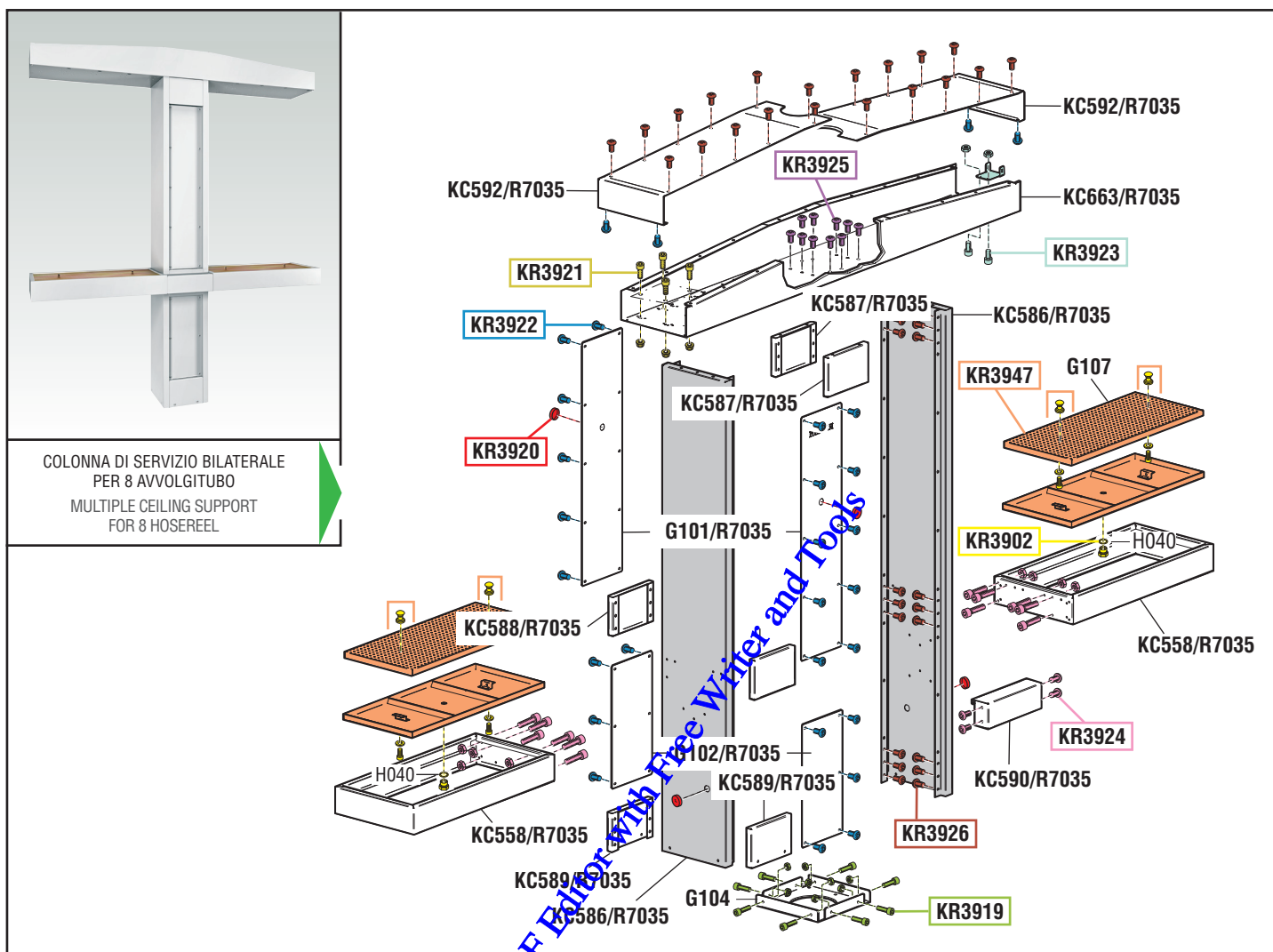

COLONNA DI SERVIZIO BILATERALE
PER 8 AVVOLGITUBO
MULTIPLE CEILING SUPPORT
FOR 8 HOSE REEL

GUIDA RICAMBI - SPARE PARTS GUIDE

KIT RICAMBI

OGNI KIT SOTTO RIPORTATO COMPRENDE I RICAMBI EVIDENZIATI CON LO STESSO COLORE E LE RELATIVE GUARNIZIONI. QUESTI RICAMBI NON SONO FORNIBILI SEPARATAMENTE TRanne QUELLI CODIFICATI.

SPARE PARTS KITS

EACH KIT SHOWN WITH THE SAME COLOR INCLUDES ALSO THE GASKETS. THE SPARE PARTS INCLUDED IN THE KIT CAN'T BE SUPPLIED SEPARATELY EXCEPT THOSE SHOWN WITH A PROPER CODE.

CODICE CODE	DESCRIZIONE DESCRIPTION	Q.TÀ QTY
KR3902	TAPPI VASCHETTA - POMELLI E GRIGLIE PLUGS FOR BASIN AND KNOBS FOR NET	1
KR3919	VITERIA FISSAGGIO BASAMENTO SCREWS FOR BASE FIXING	1
KR3920	TAPPI COPRIFORO PLUGS FOR HOLES	1
KR3921	VITERIA DI FISSAGGIO AVVOLGITUBO SCREWS FOR HOSE REEL FIXING	1
KR3922	VITERIA DI FISSAGGIO SCATOLATI SCREWS FOR COVERS FIXING	1
KR3923	STAFFETTE FISSAGGIO VALVOLE E VITERIA VALVES FIXING BRACKETS AND SCREWS	1
KR3924	VITERIA PROFILO VASCA RACCOLTA-SCATOLATO SCREWS FOR BASIN CARTER	1
KR3925	VITERIA FISSAGGIO PROFILO FIXING SCREWS	1
KR3926	VITERIA FISSAGGI ESTERNI SCREWS FOR LATERAL SUPPORT FIXING	1
KR3947	VASCA DI RECUPERO DRIP-TRAY	2

ELENCO RICAMBI FORNIBILI SINGOLARMENTE

LIST OF SPARE PARTS WHICH CAN BE SUPPLIED SEPARATELY

CODICE CODE	DESCRIZIONE DESCRIPTION	Q.TÀ QTY
G101/R7035	PANNELLO ISPEZIONALE ALTO HIGH COVER	2
G102/R7035	PANNELLO ISPEZIONALE BASSO LOW COVER	2
G104	BASAMENTO COLONNA COLUMN BASE	1
H040	O-RING 123 O-RING 123	2
KC558/R7035	PROFILO SALDATO PORTAVASCA BASIN SUPPORT	2
KC586/R7035	SPALLA PER COLONNA COLUMN SHOULDER	2
KC587/R7035	SCATOLATO SUPERIORE UPPER CARTER	2
KC588/R7035	SCATOLATO MEDIANO INTERMEDIATE CARTER	2
KC589/R7035	SCATOLATO BASSO LOWER CARTER	2
KC590/R7035	SCATOLATO INTERMEDIO PROFILI INTERMEDIATE COVER	1
KC663/R7035	PROFILO ATTACCO AVVOLGITUBO BAR FOR HOSE REEL FIXING	1
KC592/R7035	CARTER CHIUSURA PROFILO AVVOLGITUBO UPPER COVER	2

tutti i diritti riservati - all rights reserved



Art. 39334



VISTA ESPLOSA - EXPLODED VIEW

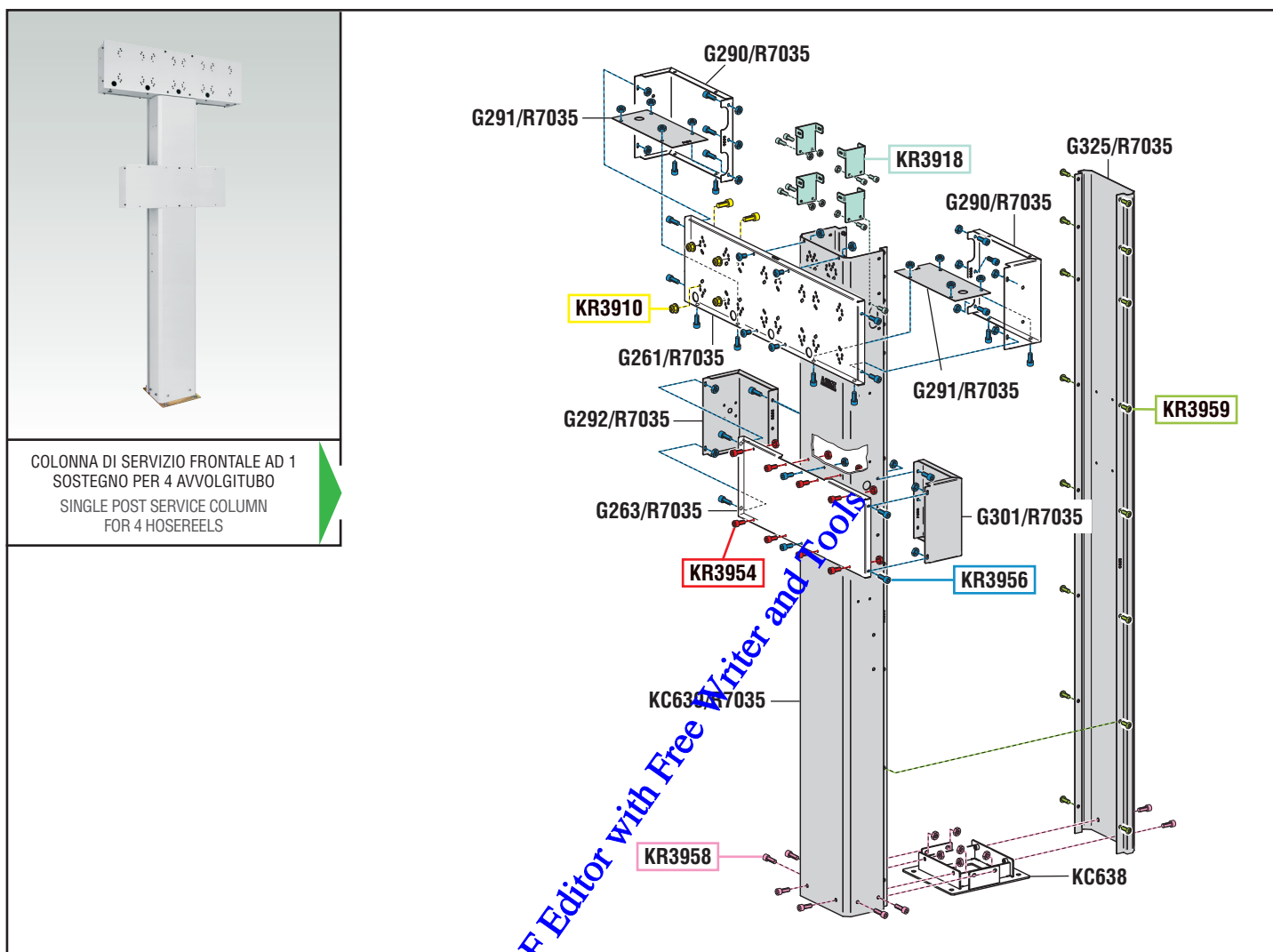

COLONNA DI SERVIZIO FRONTALE AD 1
SOSTEGNO PER 4 AVVOLGITUBO
SINGLE POST SERVICE COLUMN
FOR 4 HOSE REELS

tutti i diritti riservati - all rights reserved

GUIDA RICAMBI - SPARE PARTS GUIDE

KIT RICAMBI

OGNI KIT SOTTO RIPORTATO COMPRENDE I RICAMBI EVIDENZIATI CON LO STESSO COLORE E LE RELATIVE GUARNIZIONI. QUESTI RICAMBI NON SONO FORNIBILI SEPARATAMENTE TRAMITE QUELLI CODIFICATI.

SPARE PARTS KITS

EACH KIT SHOWN WITH THE SAME COLOR INCLUDES ALSO THE GASKETS. THE SPARE PARTS INCLUDED IN THE KIT CAN'T BE SUPPLIED SEPARATELY EXCEPT THOSE SHOWN WITH A PROPER CODE.

CODICE CODE	DESCRIZIONE DESCRIPTION	Q.TÀ QTY
KR3910	VITERIA DI FISSAGGIO AVVOLGITUBO SCREWS FOR HOSE REEL FIXING	1
KR3918	VITERIA FISSAGGIO VALVOLE SCREWS FOR VALVES FIXING	1
KR3954	VITERIA FISSAGGIO SALVAGOCCE SCREWS FOR DRIP-TRAY FIXING	1
KR3956	VITERIA FISSAGGI ESTERNI SCREWS FOR LATERAL SUPPORT FIXING	1
KR3958	VITERIA DI FISSAGGIO BASAMENTO SCREWS FOR BASE FIXING	1
KR3959	VITERIA FISSAGGIO PROFILI SCREWS FOR BARS FIXING	1

ELENCO RICAMBI FORNIBILI SINGOLARMENTE

LIST OF SPARE PARTS WHICH CAN BE SUPPLIED SEPARATELY

CODICE CODE	DESCRIZIONE DESCRIPTION	Q.TÀ QTY
G261/R7035	PANNELLO PER 4 AVVOLGITUBO 4 HOSE REEL PANEL	1
G263/R7035	PANNELLO SALVAGOCCE DRIP-TRAY PANEL	1
G290/R7035	PANNELLO DI CHIUSURA LOCKING PANEL	2
G291/R7035	PIASTRA PER PANNELLO PLATE FOR PANEL	2
G292/R7035	SCATOLATO BASSO LOWER CARTER	1
G301/R7035	PANNELLO DI CHIUSURA LOCKING PANEL	1
G325/R7035	SPALLA PER COLONNA COLUMN SHOULDER	1
KC638	BASAMENTO COLONNA COLUMN BASE	1
KC639/R7035	SPALLA PER COLONNA COLUMN SHOULDER	1



Art. 39335



VISTA ESPLOSA - EXPLODED VIEW

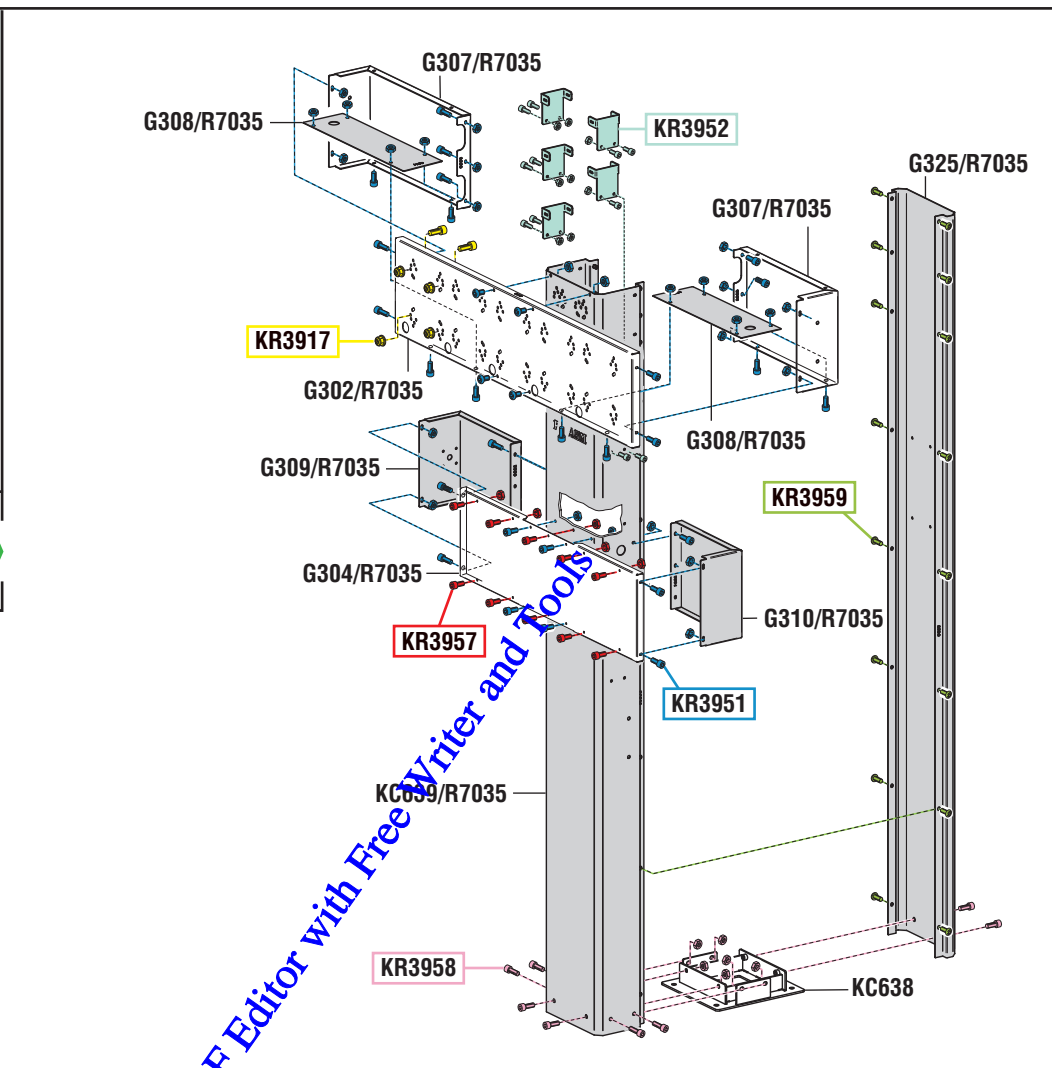

GUIDA RICAMBI - SPARE PARTS GUIDE

KIT RICAMBI
OGNI KIT SOTTO RIPORTATO COMPRENDE I RICAMBI EVIDENZIATI CON LO STESSO COLORE E LE RELATIVE GUARNIZIONI. QUESTI RICAMBI NON SONO FORNIBILI SEPARATAMENTE TRanne QUELLI CODIFICATI.

SPARE PARTS KITS
EACH KIT SHOWN WITH THE SAME COLOR INCLUDES ALSO THE GASKETS. THE SPARE PARTS INCLUDED IN THE KIT CAN'T BE SUPPLIED SEPARATELY EXCEPT THOSE SHOWN WITH A PROPER CODE.

CODICE CODE	DESCRIZIONE DESCRIPTION	Q.TÀ QTY
KR3917	VITERIA DI FISSAGGIO AVVOLGITUBO SCREWS FOR HOSEREEL FIXING	1
KR3951	VITERIA FISSAGGI ESTERNI SCREWS FOR LATERAL SUPPORT FIXING	1
KR3952	STAFFETTE FISSAGGIO VALVOLE E VITERIA BRACKETS FOR VALVES FIXING AND SCREWS	1
KR3957	STAFFETTE FISSAGGIO SALVAGOCCE BRACKETS FOR DRIP-TRAY FIXING	1
KR3958	VITERIA DI FISSAGGIO BASAMENTO SCREWS FOR BASE FIXING	1
KR3959	VITERIA FISSAGGIO PROFILI SCREWS FOR BARS FIXING	1

ELENCO RICAMBI FORNIBILI SINGOLARMENTE
LIST OF SPARE PARTS WHICH CAN BE SUPPLIED SEPARATELY

CODICE CODE	DESCRIZIONE DESCRIPTION	Q.TÀ QTY
G302/R7035	PANNELLO PER 5 AVVOLGITUBO 5 HOSEREEL PANEL	1
G304/R7035	PANNELLO SALVAGOCCE DRIP-TRAY PANEL	1
G307/R7035	PANNELLO DI CHIUSURA LOCKING PANEL	2
G308/R7035	PIASTRA PER PANNELLO PLATE FOR PANEL	2
G309/R7035	PANNELLO DI CHIUSURA LOCKING PANEL	1
G310/R7035	PANNELLO DI CHIUSURA LOCKING PANEL	1
G325/R7035	SPALLA PER COLONNA COLUMN SHOULDER	1
KC638	BASAMENTO COLONNA COLUMN BASE	1
KC639/R7035	SPALLA PER COLONNA COLUMN SHOULDER	1

tutti i diritti riservati - all rights reserved



Art. 39336



VISTA ESPLOSA - EXPLODED VIEW

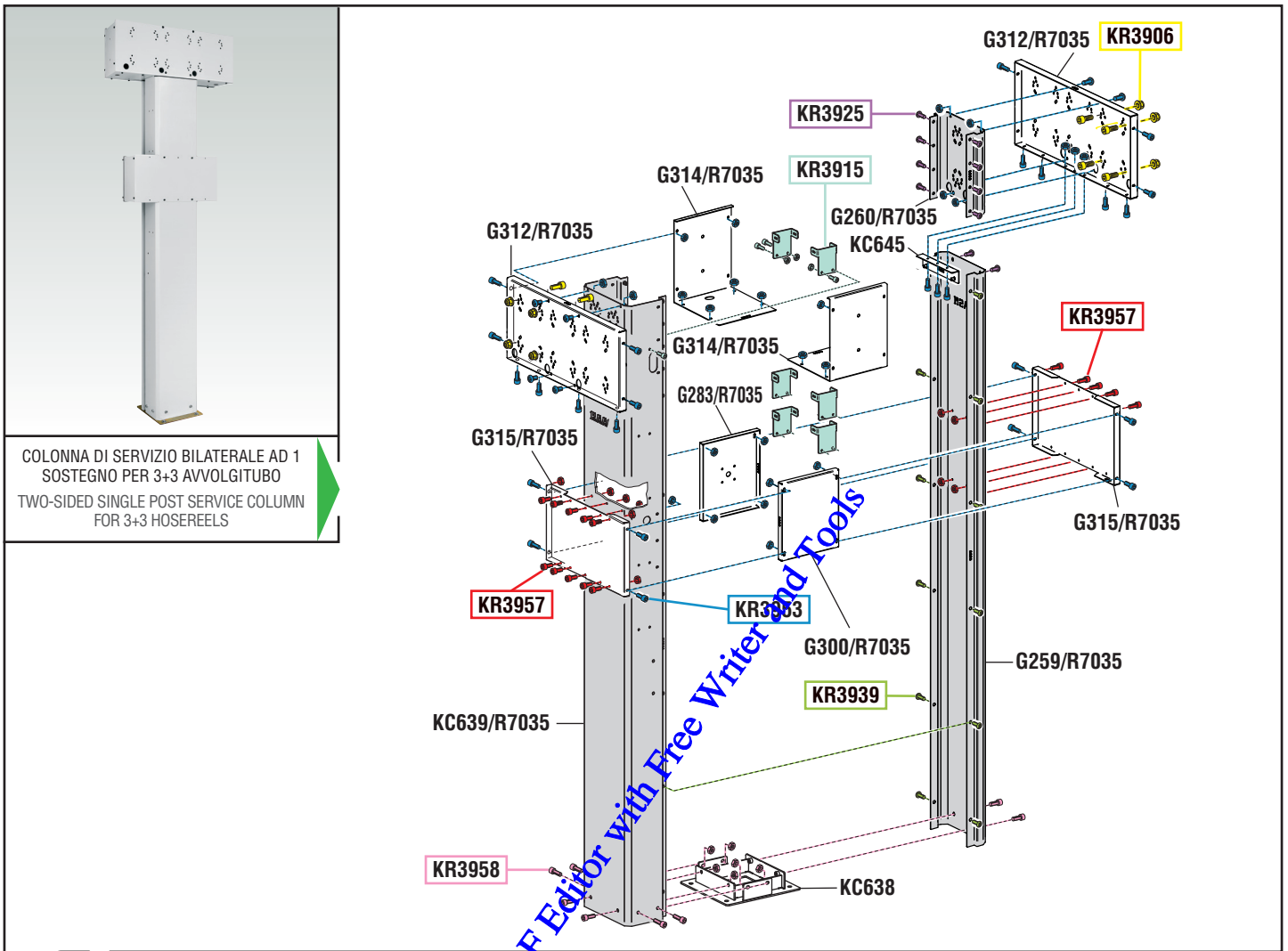

COLONNA DI SERVIZIO BILATERALE AD 1
SOSTEGNO PER 3+3 AVVOLGITUBO
TWO-SIDED SINGLE POST SERVICE COLUMN
FOR 3+3 HOSE REELS

tutti i diritti riservati - all rights reserved

GUIDA RICAMBI - SPARE PARTS GUIDE

KIT RICAMBI

OGNI KIT SOTTO RIPORTATO COMPRENDE I RICAMBI EVIDENZIATI CON LO STESSO COLORE E LE RELATIVE GUARNIZIONI. QUESTI RICAMBI NON SONO FORNIBILI SEPARATAMENTE TRAMITE QUELLI CODIFICATI.

SPARE PARTS KITS

EACH KIT SHOWN WITH THE SAME COLOR INCLUDES ALSO THE GASKETS. THE SPARE PARTS INCLUDED IN THE KIT CAN'T BE SUPPLIED SEPARATELY EXCEPT THOSE SHOWN WITH A PROPER CODE.

CODICE CODE	DESCRIZIONE DESCRIPTION	Q.TÀ QTY
KR3906	VITERIA DI FISSAGGIO AVVOLGITUBO SCREWS FOR HOSE REEL FIXING	1
KR3915	VITERIA DI FISSAGGIO VALVOLE SCREWS FOR VALVES	1
KR3925	VITERIA FISSAGGIO PROFILO FIXING SCREWS	1
KR3939	VITERIA FISSAGGIO PROFILI SCREWS FOR BARS FIXING	1
KR3953	VITERIA FISSAGGI ESTERNI SCREWS FOR LATERAL SUPPORT FIXING	1
KR3957	STAFFETTE FISSAGGIO SALVAGOCCE BRACKETS FOR DRIP-TRAY FIXING	2
KR3958	VITERIA DI FISSAGGIO BASAMENTO SCREWS FOR BASE FIXING	1

ELENCO RICAMBI FORNIBILI SINGOLARMENTE

LIST OF SPARE PARTS WHICH CAN BE SUPPLIED SEPARATELY

CODICE CODE	DESCRIZIONE DESCRIPTION	Q.TÀ QTY
G259/R7035	PROFILO ESTERNO INFERIORE INFERIOR EXTERNAL PROFILE	1
G260/R7035	PROFILO ESTERNO SUPERIORE SUPERIOR EXTERNAL PROFILE	1
G283/R7035	SCATOLA CHIUSURA PANNELLO LOCKING PANEL BOX	1
G300/R7035	SCATOLA CHIUSURA PANNELLO LOCKING PANEL BOX	1
G312/R7035	PANNELLO PER 3 AVVOLGITUBO 3 HOSE REEL PANEL	2
G314/R7035	PROFILO CHIUSURA PANNELLO LOCKING PANEL PROFILE	2
G315/R7035	PANNELLO SALVAGOCCE DRIP-TRAY PROFILE	2
KC638	BASAMENTO COLONNA COLUMN BASE	1
KC639/R7035	SPALLA PER COLONNA COLUMN SHOULDER	1
KC645	PROFILO DI COLLEGAMENTO CONNECTION PROFILE	1



Art. 39338



VISTA ESPLOSA - EXPLODED VIEW

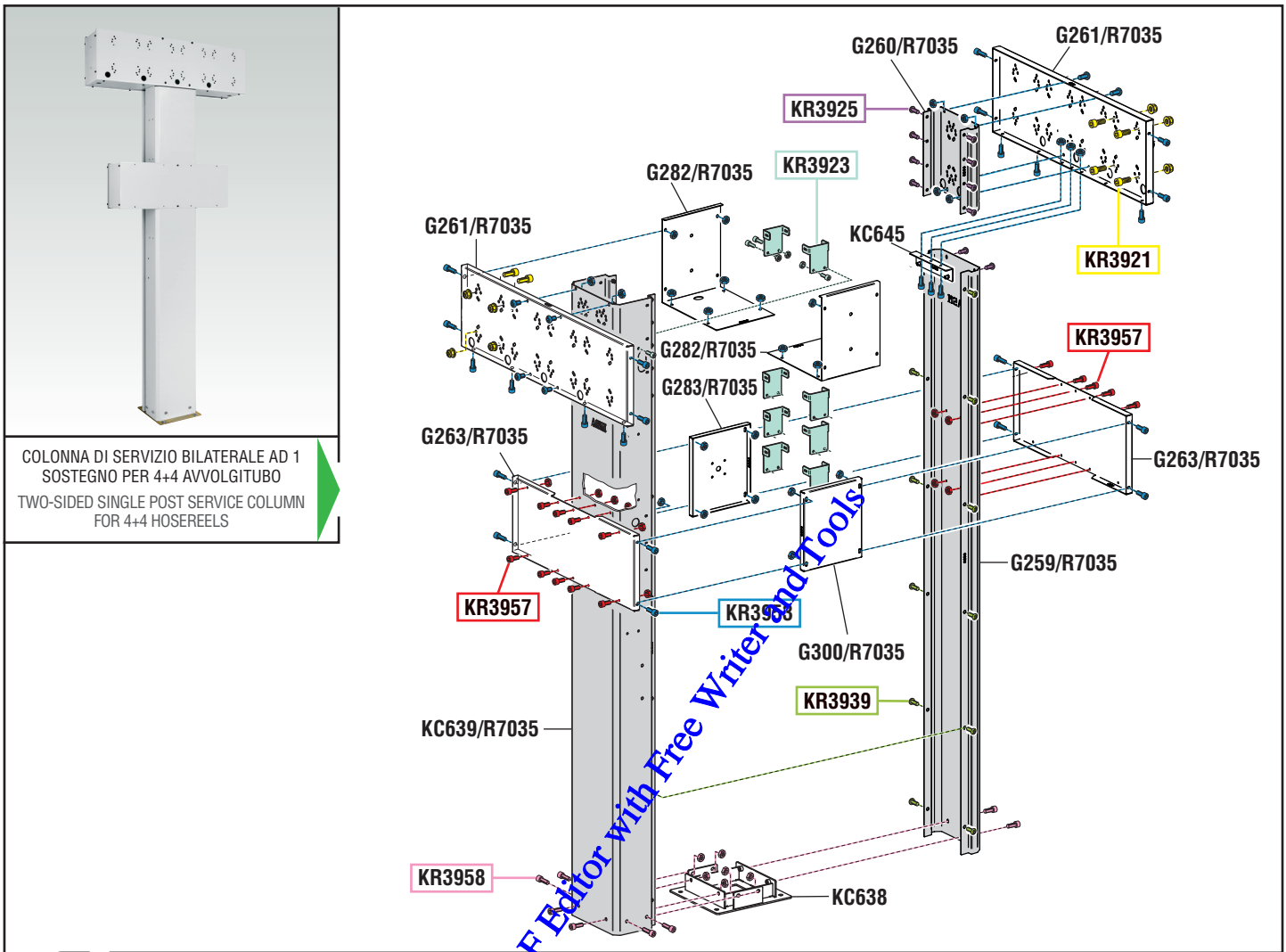

COLONNA DI SERVIZIO BILATERALE AD 1
SOSTEGNO PER 4+4 AVVOLGITUBO
TWO-SIDED SINGLE POST SERVICE COLUMN
FOR 4+4 HOSE REELS

tutti i diritti riservati - all rights reserved

GUIDA RICAMBI - SPARE PARTS GUIDE

KIT RICAMBI

OGNI KIT SOTTO RIPORTATO COMPRENDE I RICAMBI EVIDENZIATI CON LO STESSO COLORE E LE RELATIVE GUARNIZIONI. QUESTI RICAMBI NON SONO FORNIBILI SEPARATAMENTE TRAMIE QUELLI CODIFICATI.

SPARE PARTS KITS

EACH KIT SHOWN WITH THE SAME COLOR INCLUDES ALSO THE GASKETS. THE SPARE PARTS INCLUDED IN THE KIT CAN'T BE SUPPLIED SEPARATELY EXCEPT THOSE SHOWN WITH A PROPER CODE.

CODICE CODE	DESCRIZIONE DESCRIPTION	Q.TÀ QTY
KR3921	VITERIA DI FISSAGGIO AVVOLGITUBO SCREWS FOR HOSE REEL FIXING	1
KR3923	STAFFETTE FISSAGGIO VALVOLE E VITERIA VALVES FIXING BRACKETS AND SCREWS	1
KR3925	VITERIA FISSAGGIO PROFILO AVVOLGITUBO SCREWS FOR PROFILE HOSE REEL FIXING	1
KR3939	VITERIA FISSAGGIO PROFILI SCREWS FOR BARS FIXING	1
KR3953	VITERIA FISSAGGI ESTERNI SCREWS FOR LATERAL SUPPORT FIXING	1
KR3957	STAFFETTE FISSAGGIO SALVAGOCCIE BRACKETS FOR DRIP-TRAY FIXING	2
KR3958	VITERIA DI FISSAGGIO BASAMENTO SCREWS FOR BASE FIXING	1

ELENCO RICAMBI FORNIBILI SINGOLARMENTE

LIST OF SPARE PARTS WHICH CAN BE SUPPLIED SEPARATELY

CODICE CODE	DESCRIZIONE DESCRIPTION	Q.TÀ QTY
G259/R7035	PROFILO ESTERNO INFERIORE INFERIOR EXTERNAL PROFILE	1
G260/R7035	PROFILO ESTERNO SUPERIORE SUPERIOR EXTERNAL PROFILE	1
G261/R7035	PANNELLO PER 4 AVVOLGITUBO 4 HOSE REEL PANEL	2
G263/R7035	PANNELLO SALVAGOCCIE DRIP-TRAY PANEL	2
G282/R7035	PROFILO CHIUSURA PANNELLO LOCKING PANEL PROFILE	2
G283/R7035	SCATOLA CHIUSURA PANNELLO LOCKING PANEL BOX	1
G300/R7035	SCATOLA CHIUSURA PANNELLO LOCKING PANEL BOX	1
KC638	BASAMENTO COLONNA COLUMN BASE	1
KC639/R7035	SPALLA PER COLONNA COLUMN SHOULDER	1
KC645	PROFILO DI COLLEGAMENTO CONNECTION PROFILE	1



Art. 39340



VISTA ESPLOSA - EXPLODED VIEW

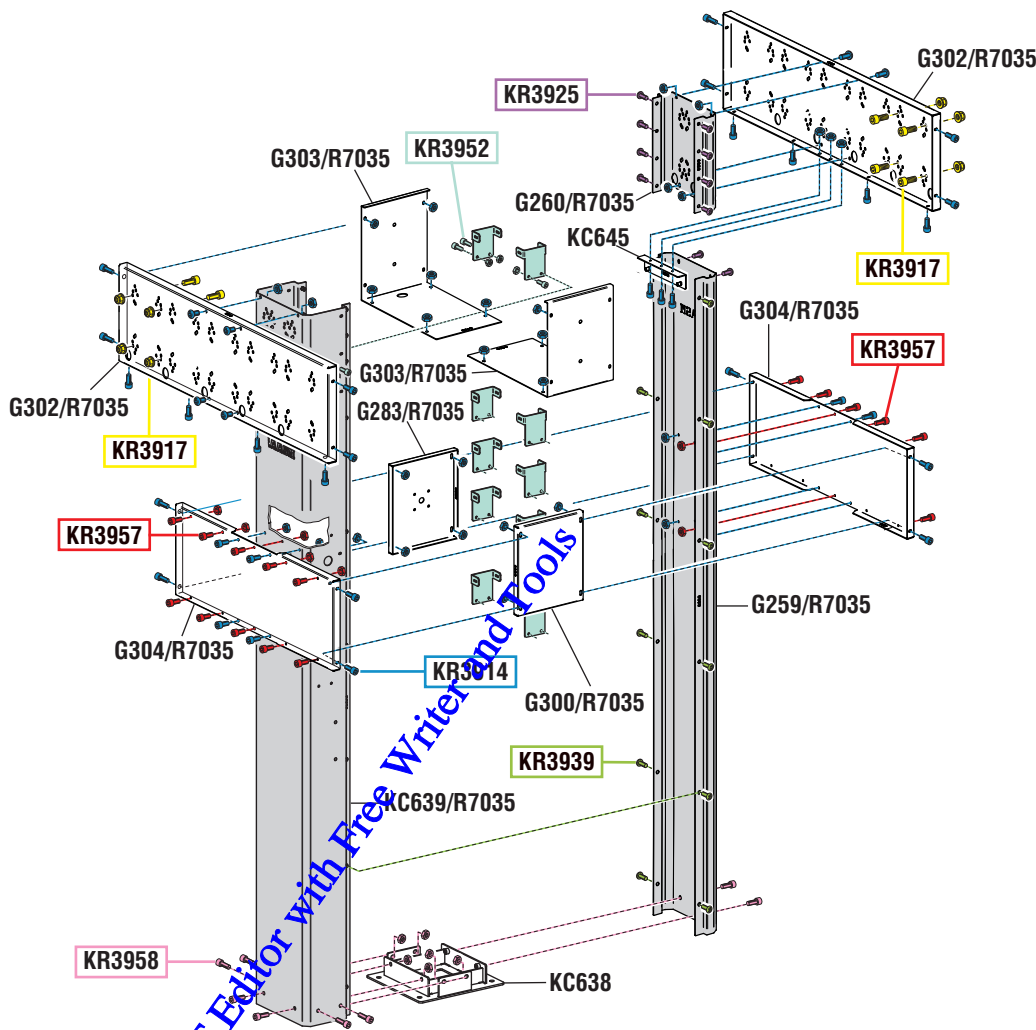

tutti i diritti riservati - all rights reserved

GUIDA RICAMBI - SPARE PARTS GUIDE

KIT RICAMBI
OGNI KIT SOTTO RIPORTATO COMPRENDE I RICAMBI EVIDENZIATI CON LO STESSO COLORE E LE RELATIVE GUARNIZIONI. QUESTI RICAMBI NON SONO FORNIBILI SEPARATAMENTE TRAMITE QUELLI CODIFICATI.

SPARE PARTS KITS
EACH KIT SHOWN WITH THE SAME COLOR INCLUDES ALSO THE GASKETS. THE SPARE PARTS INCLUDED IN THE KIT CAN'T BE SUPPLIED SEPARATELY EXCEPT THOSE SHOWN WITH A PROPER CODE.

CODICE CODE	DESCRIZIONE DESCRIPTION	Q.TÀ QTY
KR3914	VITERIA FISSAGGI ESTERNI SCREWS FOR LATERAL SUPPORT FIXING	1
KR3917	VITERIA DI FISSAGGIO AVVOLGITUBO SCREWS FOR HOSE REEL FIXING	2
KR3925	VITERIA FISSAGGIO PROFILO AVVOLGITUBO SCREWS FOR PROFILE HOSE REEL FIXING	1
KR3939	VITERIA FISSAGGIO PROFILI SCREWS FOR BARS FIXING	1
KR3952	STAFFETTE FISSAGGIO VALVOLE E VITERIA BRACKETS FOR VALVES FIXING AND SCREWS	2
KR3957	STAFFETTE FISSAGGIO SALVAGOCCE BRACKETS FOR DRIP-TRAY FIXING	2
KR3958	VITERIA DI FISSAGGIO BASAMENTO SCREWS FOR BASE FIXING	1

ELENCO RICAMBI FORNIBILI SINGOLARMENTE
LIST OF SPARE PARTS WHICH CAN BE SUPPLIED SEPARATELY

CODICE CODE	DESCRIZIONE DESCRIPTION	Q.TÀ QTY
G259/R7035	PROFILO ESTERNO INFERIORE INFERIOR EXTERNAL PROFILE	1
G260/R7035	PROFILO ESTERNO SUPERIORE SUPERIOR EXTERNAL PROFILE	1
G283/R7035	SCATOLA CHIUSURA PANNELLO LOCKING PANEL BOX	1
G300/R7035	SCATOLA CHIUSURA PANNELLO LOCKING PANEL BOX	1
G302/R7035	PANNELLO PER 5 AVVOLGITUBO 5 HOSE REEL PANEL	2
G303/R7035	PROFILO CHIUSURA PANNELLO LOCKING PANEL PROFILE	2
G304/R7035	PANNELLO SALVAGOCCE DRIP-TRAY PANEL	2
KC638	BASAMENTO COLONNA COLUMN BASE	1
KC639/R7035	SPALLA PER COLONNA COLUMN SHOULDER	1
KC645	PROFILO DI COLLEGAMENTO CONNECTION PROFILE	1



Art. 39351



VISTA ESPLOSA - EXPLODED VIEW

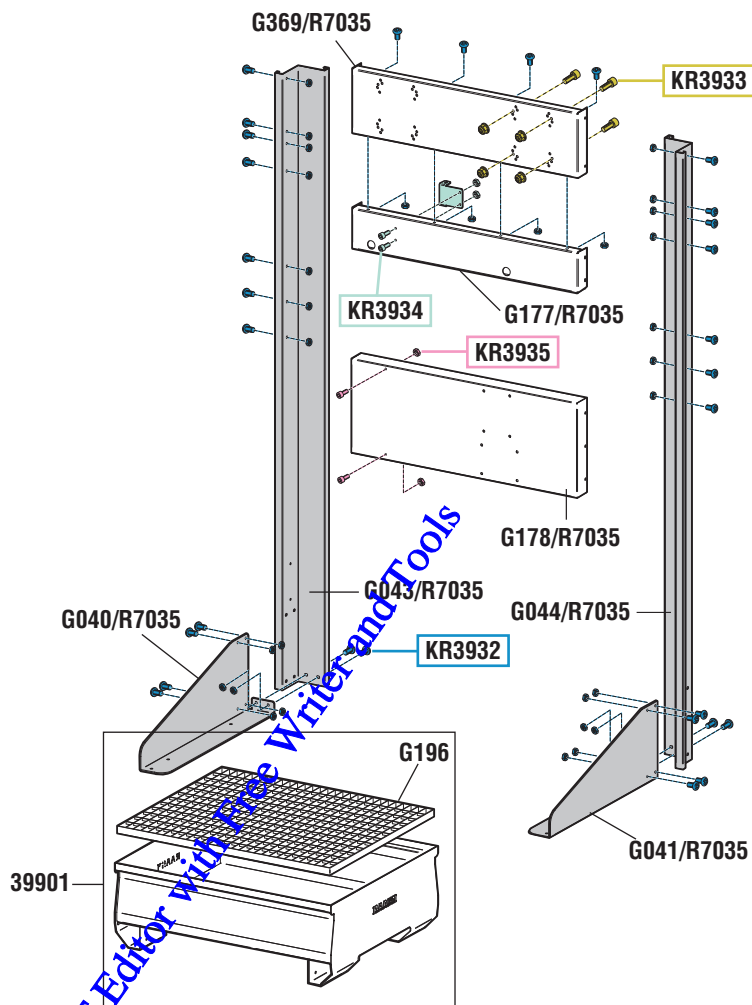

GUIDA RICAMBI - SPARE PARTS GUIDE

KIT RICAMBI

OGNI KIT SOTTO RIPORTATO COMPRENDE I RICAMBI EVIDENZIATI CON LO STESSO COLORE E LE RELATIVE GUARNIZIONI. QUESTI RICAMBI NON SONO FORNIBILI SEPARATAMENTE TRAMITE QUELLI CODIFICATI.

SPARE PARTS KITS

EACH KIT SHOWN WITH THE SAME COLOR INCLUDES ALSO THE GASKETS. THE SPARE PARTS INCLUDED IN THE KIT CAN'T BE SUPPLIED SEPARATELY EXCEPT THOSE SHOWN WITH A PROPER CODE.

CODICE CODE	DESCRIZIONE DESCRIPTION	Q.TÀ QTY
KR3932	VITERIA FISSAGGIO ESTERNI SCREWS FOR LATERAL SUPPORTS	1
KR3933	VITERIA FISSAGGIO AVVOLGITUBO SCREWS FOR HOSE REEL FIXING	1
KR3934	STAFFETTE FISSAGGIO VALVOLE E VITERIA BRACKETS FOR VALVES FIXING AND SCREWS	1
KR3935	VITERIA FISSAGGIO RACCOGLIGOCCE SCREWS FOR DRIP-TRAY FIXING	1

ELENCO RICAMBI FORNIBILI SINGOLARMENTE

LIST OF SPARE PARTS WHICH CAN BE SUPPLIED SEPARATELY

CODICE CODE	DESCRIZIONE DESCRIPTION	Q.TÀ QTY
39901	VASCA DI CONTENIMENTO CONTAINMENT TANK	1
G040/R7035	GAMBA SINISTRA LEFT LEG	1
G041/R7035	GAMBA DESTRA RIGHT LEG	1
G043/R7035	COLONNA SINISTRA LEFT COLUMN	1
G044/R7035	COLONNA DESTRA RIGHT COLUMN	1
G177/R7035	PANNELLO SUPPORTO VALVOLE E ACCESSORI SUPPORT FOR VALVES AND ACCESSORIES	1
G178/R7035	PANNELLO SUPPORTO RACCOGLIGOCCE SUPPORT FOR DRIP-TRAY	1
G196	GRIGLIA NET	1
G369/R7035	PANNELLO PER 2 AVVOLGITUBO 2 HOSE REEL PANEL	1



Art. 39352



VISTA ESPLOSA - EXPLODED VIEW



COLONNA DI SERVIZIO FRONTALE
CON VASCA DI CONTENIMENTO
MULTIPLE SUPPORT FRONTAL
WITH CONTAINMENT TANK

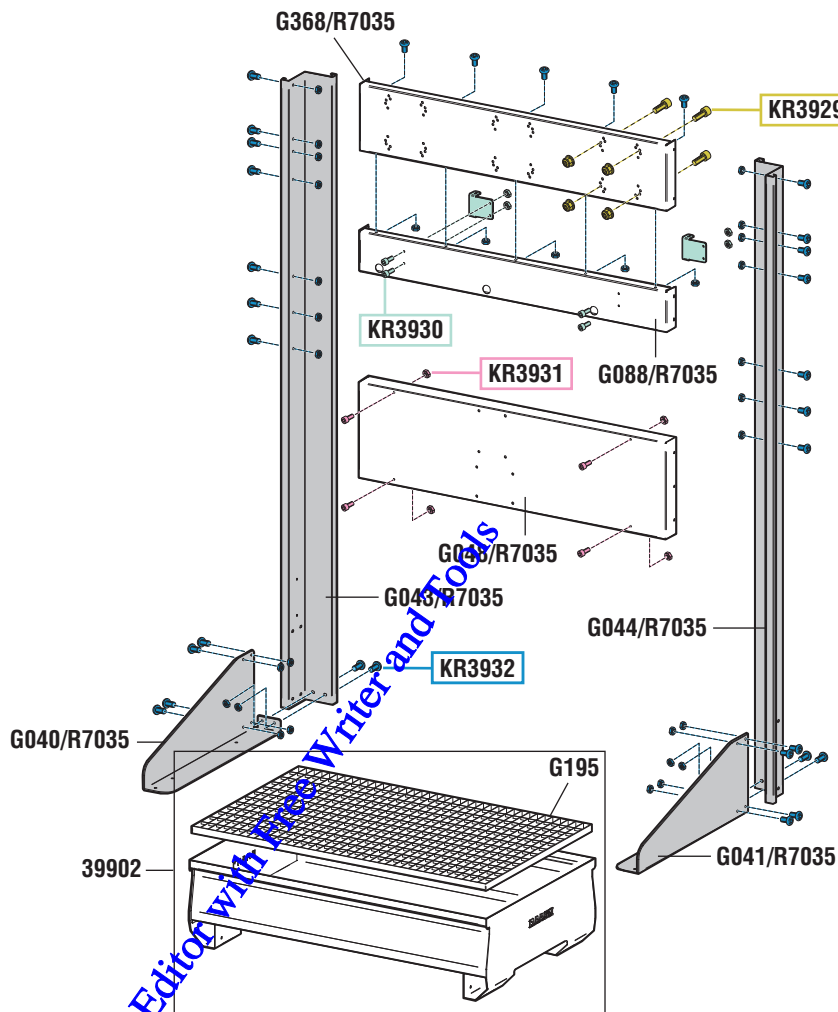

GUIDA RICAMBI - SPARE PARTS GUIDE

KIT RICAMBI
OGNI KIT SOTTO RIPORTATO COMPRENDE I RICAMBI EVIDENZIATI CON LO STESSO COLORE E LE RELATIVE GUARNIZIONI. QUESTI RICAMBI NON SONO FORNIBILI SEPARATAMENTE TRAMITE QUELLI CODIFICATI.

SPARE PARTS KITS
EACH KIT SHOWN WITH THE SAME COLOR INCLUDES ALSO THE GASKETS. THE SPARE PARTS INCLUDED IN THE KIT CAN'T BE SUPPLIED SEPARATELY EXCEPT THOSE SHOWN WITH A PROPER CODE.

CODICE CODE	DESCRIZIONE DESCRIPTION	Q.TÀ QTY
KR3929	VITERIA FISSAGGIO AVVOLGITUBO SCREWS FOR HOSEREEL FIXING	1
KR3930	STAFFETTE FISSAGGIO VALVOLE E VITERIA BRACKETS FOR VALVES FIXING AND SCREWS	1
KR3931	VITERIA FISSAGGIO SALVAGOCCE SCREWS FOR DRIP-TRAY FIXING	1
KR3932	VITERIA FISSAGGIO ESTERNI SCREWS FOR LATERAL SUPPORTS	1

ELENCO RICAMBI FORNIBILI SINGOLARMENTE
LIST OF SPARE PARTS WHICH CAN BE SUPPLIED SEPARATELY

CODICE CODE	DESCRIZIONE DESCRIPTION	Q.TÀ QTY
39902	VASCA DI CONTENIMENTO CONTAINMENT TANK	1
G040/R7035	GAMBA SINISTRA LEFT LEG	1
G041/R7035	GAMBA DESTRA RIGHT LEG	1
G043/R7035	COLONNA SINISTRA LEFT COLUMN	1
G044/R7035	COLONNA DESTRA RIGHT COLUMN	1
G048/R7035	PANNELLO SUPPORTO RACCOLGIOCCE SUPPORT FOR DRIP-TRAY	1
G088/R7035	PANNELLO SUPPORTO VALVOLE ACCESSORI SUPPORT FOR VALVES AND ACCESSORIES	1
G195	GRIGLIA NET	1
G368/R7035	PANNELLO SUPPORTO 3 AVVOLGITUBO SUPPORT FOR 3 HOSEREEL	1

tutti i diritti riservati - all rights reserved



Art. 39421



VISTA ESPLOSA - EXPLODED VIEW

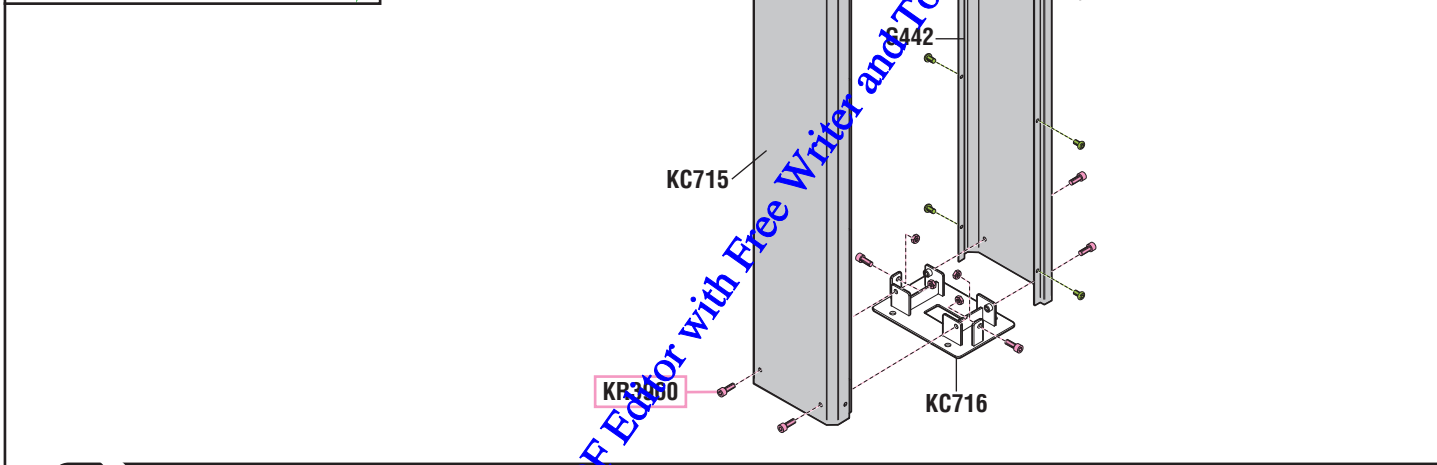
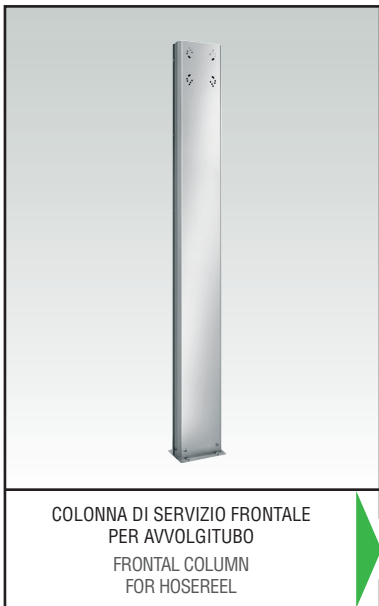

tutti i diritti riservati - all rights reserved

GUIDA RICAMBI - SPARE PARTS GUIDE

KIT RICAMBI
OGNI KIT SOTTO RIPORTATO COMPRENDE I RICAMBI EVIDENZIATI CON LO STESSO COLORE E LE RELATIVE GUARNIZIONI. QUESTI RICAMBI NON SONO FORNIBILI SEPARATAMENTE TRanne QUELLI CODIFICATI.

SPARE PARTS KITS
EACH KIT SHOWN WITH THE SAME COLOR INCLUDES ALSO THE GASKETS. THE SPARE PARTS INCLUDED IN THE KIT CAN'T BE SUPPLIED SEPARATELY EXCEPT THOSE SHOWN WITH A PROPER CODE.

CODICE CODE	DESCRIZIONE DESCRIPTION	Q.TÀ QTY
KR3960	VITERIA FISSAGGIO BASE SALDATA SCREWS FOR BASE FIXING	1
KR3961	VITERIA FISSAGGIO AVVOLGITUBO SCREWS FOR HOSEREEL FIXING	1
KR3962	VITERIA FISSAGGIO PROFILI SCREWS FOR BARS FIXING	1

ELENCO RICAMBI FORNIBILI SINGOLARMENTE
LIST OF SPARE PARTS WHICH CAN BE SUPPLIED SEPARATELY

CODICE CODE	DESCRIZIONE DESCRIPTION	Q.TÀ QTY
G442	PROFILO ESTERNO COLONNA COLUMN EXTERNAL SIDE	1
KC715	PROFILO INTERNO COLONNA COLUMN INTERNAL SIDE	1
KC716	BASE SALDATA ANCORAGGIO PAVIMENTO FLOOR BASE	1



Art. 39422



VISTA ESPLOSA - EXPLODED VIEW

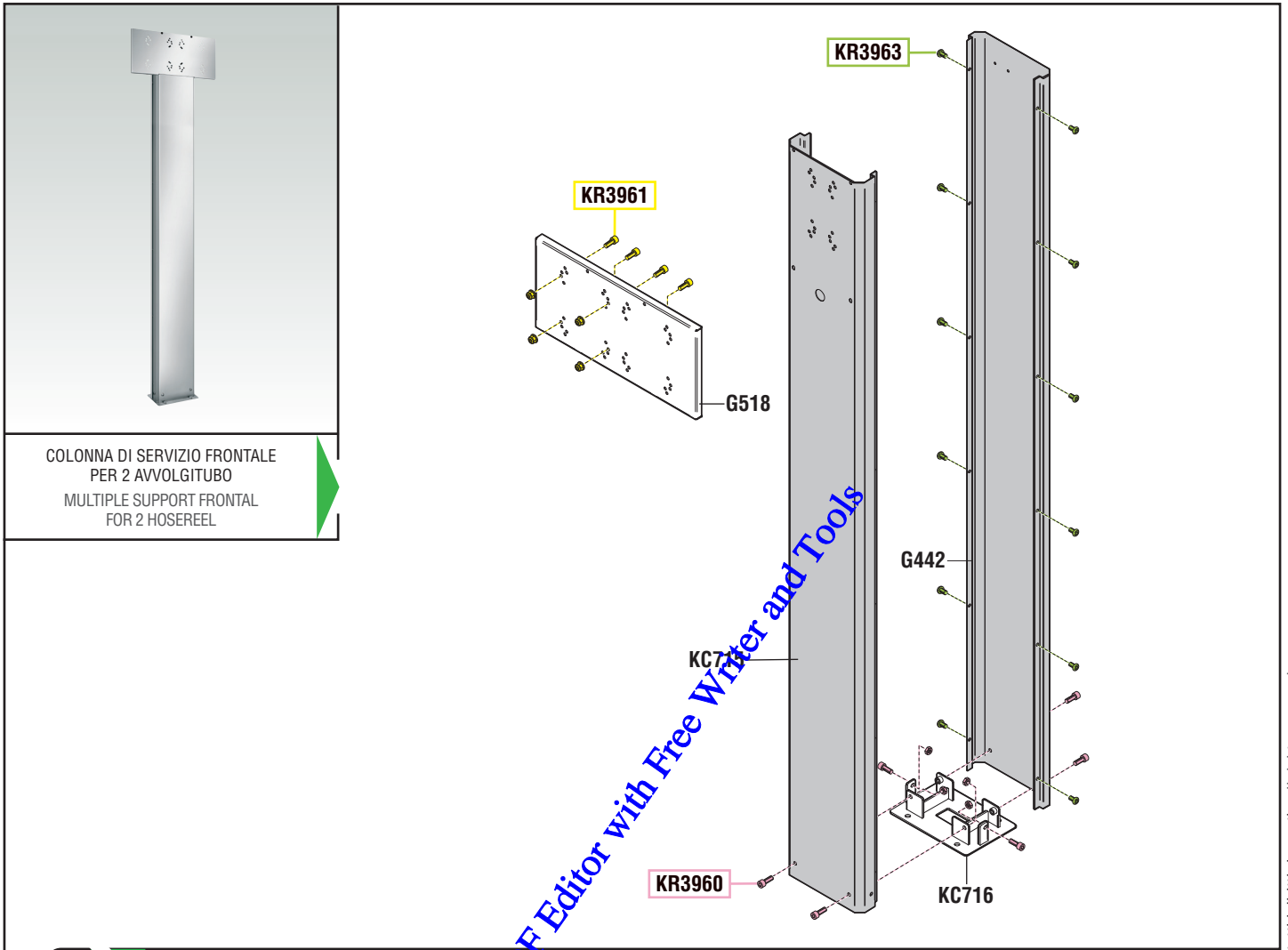

COLONNA DI SERVIZIO FRONTALE
PER 2 AVVOLGITUBO
MULTIPLE SUPPORT FRONTAL
FOR 2 HOSE REEL

GUIDA RICAMBI - SPARE PARTS GUIDE

KIT RICAMBI

OGNI KIT SOTTO RIPORTATO COMPRENDE I RICAMBI EVIDENZIATI CON LO STESSO COLORE E LE RELATIVE GUARNIZIONI. QUESTI RICAMBI NON SONO FORNIBILI SEPARATAMENTE TRAMIE QUELLI CODIFICATI.

SPARE PARTS KITS

EACH KIT SHOWN WITH THE SAME COLOR INCLUDES ALSO THE GASKETS. THE SPARE PARTS INCLUDED IN THE KIT CAN'T BE SUPPLIED SEPARATELY EXCEPT THOSE SHOWN WITH A PROPER CODE.

CODICE CODE	DESCRIZIONE DESCRIPTION	Q.TÀ QTY
KR3960	VITERIA FISSAGGIO BASE SALDATA SCREWS FOR BASE FIXING	1
KR3961	VITERIA FISSAGGIO AVVOLGITUBO SCREWS FOR HOSE REEL FIXING	2
KR3963	VITERIA FISSAGGIO PROFILI SCREWS FOR BARS FIXING	1

ELENCO RICAMBI FORNIBILI SINGOLARMENTE

LIST OF SPARE PARTS WHICH CAN BE SUPPLIED SEPARATELY

CODICE CODE	DESCRIZIONE DESCRIPTION	Q.TÀ QTY
G442	PROFILO ESTERNO COLONNA COLUMN EXTERNAL SIDE	1
G518	PANNELLO PER 2 AVVOLGITUBO 2 HOSE REEL PANEL	1
KC715	PROFILO INTERNO COLONNA COLUMN INTERNAL SIDE	1
KC716	BASE SALDATA ANCORAGGIO PAVIMENTO FLOOR BASE	1

tutti i diritti riservati - all rights reserved



Art. 42000



VISTA ESPLOSA - EXPLODED VIEW

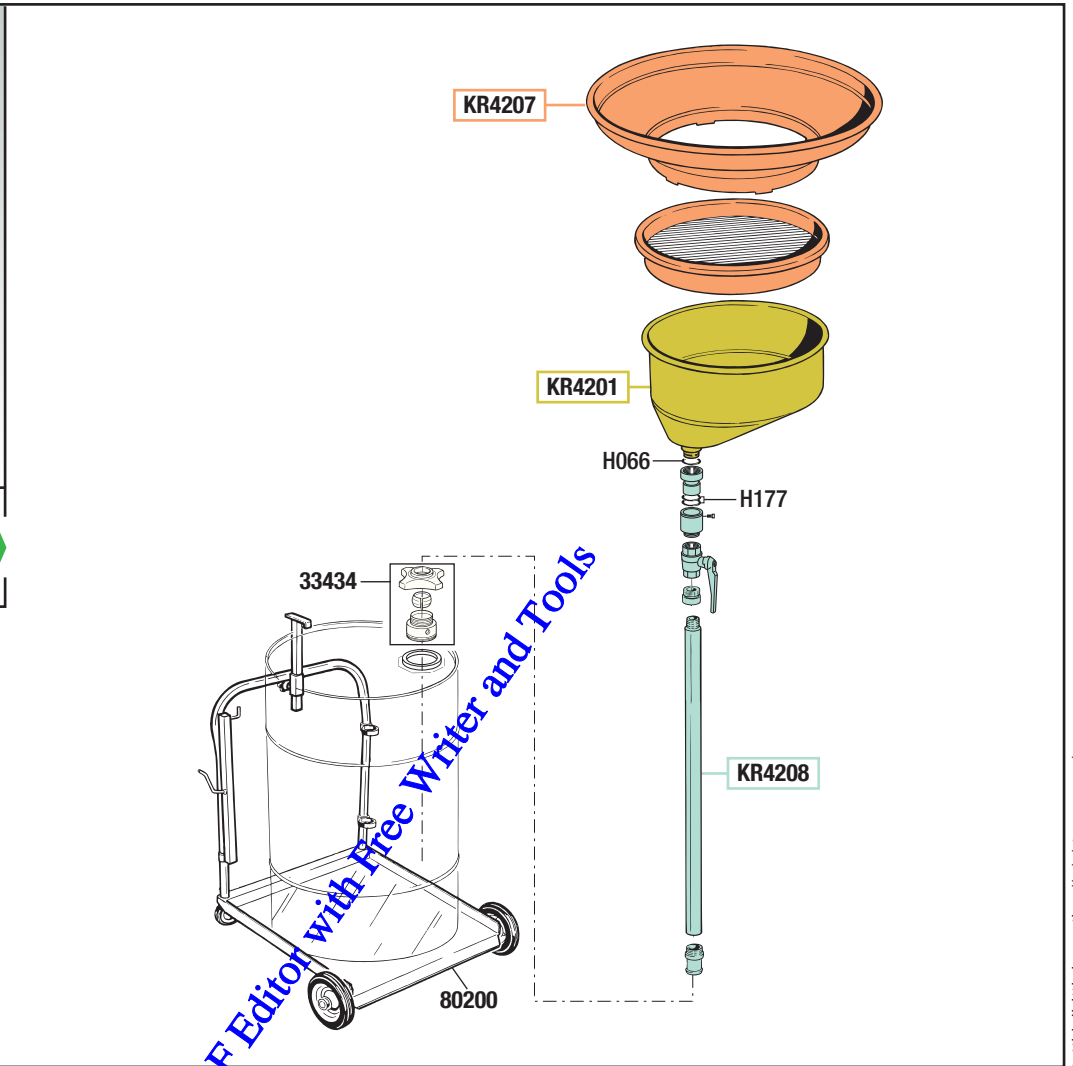

tutti i diritti riservati - all rights reserved

GUIDA RICAMBI - SPARE PARTS GUIDE

KIT RICAMBI

OGNI KIT SOTTO RIPORTATO COMPRENDE I RICAMBI EVIDENZIATI CON LO STESSO COLORE E LE RELATIVE GUARNIZIONI. QUESTI RICAMBI NON SONO FORNIBILI SEPARATAMENTE TRANNE QUELLI CODIFICATI.

SPARE PARTS KITS

EACH KIT SHOWN WITH THE SAME COLOR INCLUDES ALSO THE GASKETS. THE SPARE PARTS INCLUDED IN THE KIT CAN'T BE SUPPLIED SEPARATELY EXCEPT THOSE SHOWN WITH A PROPER CODE.

CODICE CODE	DESCRIZIONE DESCRIPTION	Q.TÀ QTY
KR4201	COPPA RACCOGLI OLIO OIL COLLECTING BOWL	1
KR4207	IMBUTO E GRIGLIA FUNNEL AND NET	1
KR4208	GRUPPO SUPPORTO COPPA BOWL SUPPORT UNIT	1

ELENCO RICAMBI FORNIBILI SINGOLARMENTE

LIST OF SPARE PARTS WHICH CAN BE SUPPLIED SEPARATELY

CODICE CODE	DESCRIZIONE DESCRIPTION	Q.TÀ QTY
80200	CARRELLO PER FUSTI DA 180 - 220 Kg TROLLEY FOR DRUMS 180 - 220 Kg	1
33434	GHIERA DI BLOCCAGGIO ø 34 mm BUNG ADAPTOR ø 34 mm	1

Art.
KR4251

KIT GUARNIZIONI COMPLETO

COMPOSTO DALLE GUARNIZIONI SOTTO ELENCAE
JOINTS GASKETS LIST
INCLUDING ALL THE GASKETS SHOWN HERE UNDER

CODICE CODE	DESCRIZIONE DESCRIPTION	Q.TÀ QTY
H066	O-RING 3118 O-RING 3118	1
H177	O-RING 4131 O-RING 4131	2



Art. 42050



VISTA ESPLOSA - EXPLODED VIEW

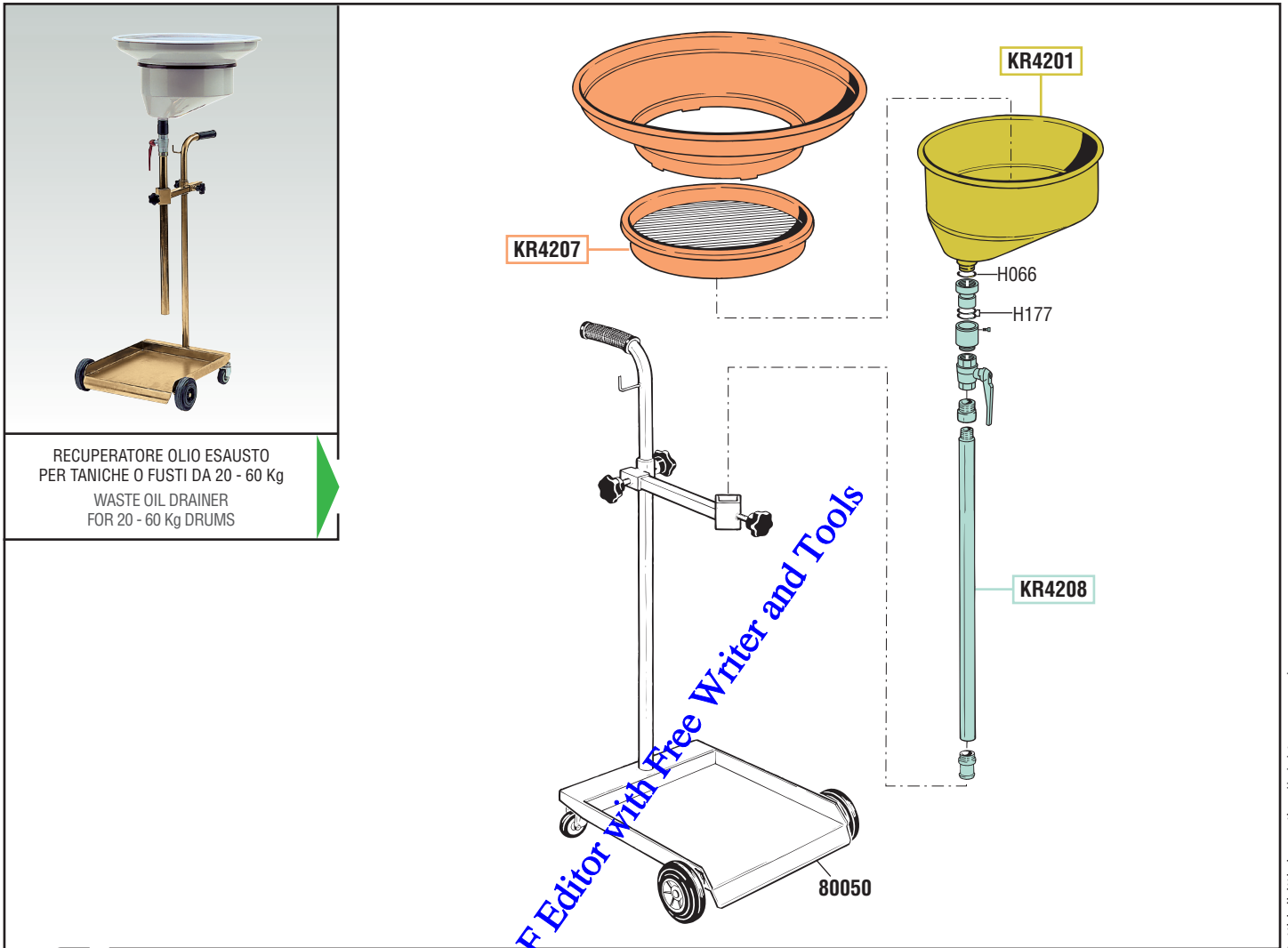

tutti i diritti riservati - all rights reserved

RECUPERATORE OLIO ESAUSTO
PER TANICHE O FUSTI DA 20 - 60 Kg
WASTE OIL DRAINER
FOR 20 - 60 Kg DRUMS

GUIDA RICAMBI - SPARE PARTS GUIDE

KIT RICAMBI
OGNI KIT SOTTO RIPORTATO COMPRENDE I RICAMBI EVIDENZIATI CON LO STESSO COLORE E LE RELATIVE GUARNIZIONI. QUESTI RICAMBI NON SONO FORNIBILI SEPARATAMENTE TRANNE QUELLI CODIFICATI.

SPARE PARTS KITS
EACH KIT SHOWN WITH THE SAME COLOR INCLUDES ALSO THE GASKETS. THE SPARE PARTS INCLUDED IN THE KIT CAN'T BE SUPPLIED SEPARATELY EXCEPT THOSE SHOWN WITH A PROPER CODE.

CODICE CODE	DESCRIZIONE DESCRIPTION	Q.TÀ QTY
KR4201	COPPA RACCOGLI OLIO OIL COLLECTING BOWL	1
KR4207	IMBUTO E GRIGLIA FUNNEL AND NET	1
KR4208	GRUPPO SUPPORTO COPPA BOWL SUPPORT UNIT	1

ELENCO RICAMBI FORNIBILI SINGOLARMENTE
LIST OF SPARE PARTS WHICH CAN BE SUPPLIED SEPARATELY

CODICE CODE	DESCRIZIONE DESCRIPTION	Q.TÀ QTY
80050	CARRELLO PER CONTENITORI DA 20 - 60 Kg TROLLEY FOR CONTAINERS 20 - 60 Kg	1

Art. KR4251 **KIT GUARNIZIONI COMPLETO**
COMPOSTO DALLE GUARNIZIONI SOTTO ELENCAE
JOINTS GASKETS LIST
INCLUDING ALL THE GASKETS SHOWN HERE UNDER

CODICE CODE	DESCRIZIONE DESCRIPTION	Q.TÀ QTY
H066	O-RING 3118 O-RING 3118	1
H177	O-RING 4131 O-RING 4131	2



Art. 42055 Mod. RO.150LF



VISTA ESPLOSA - EXPLODED VIEW

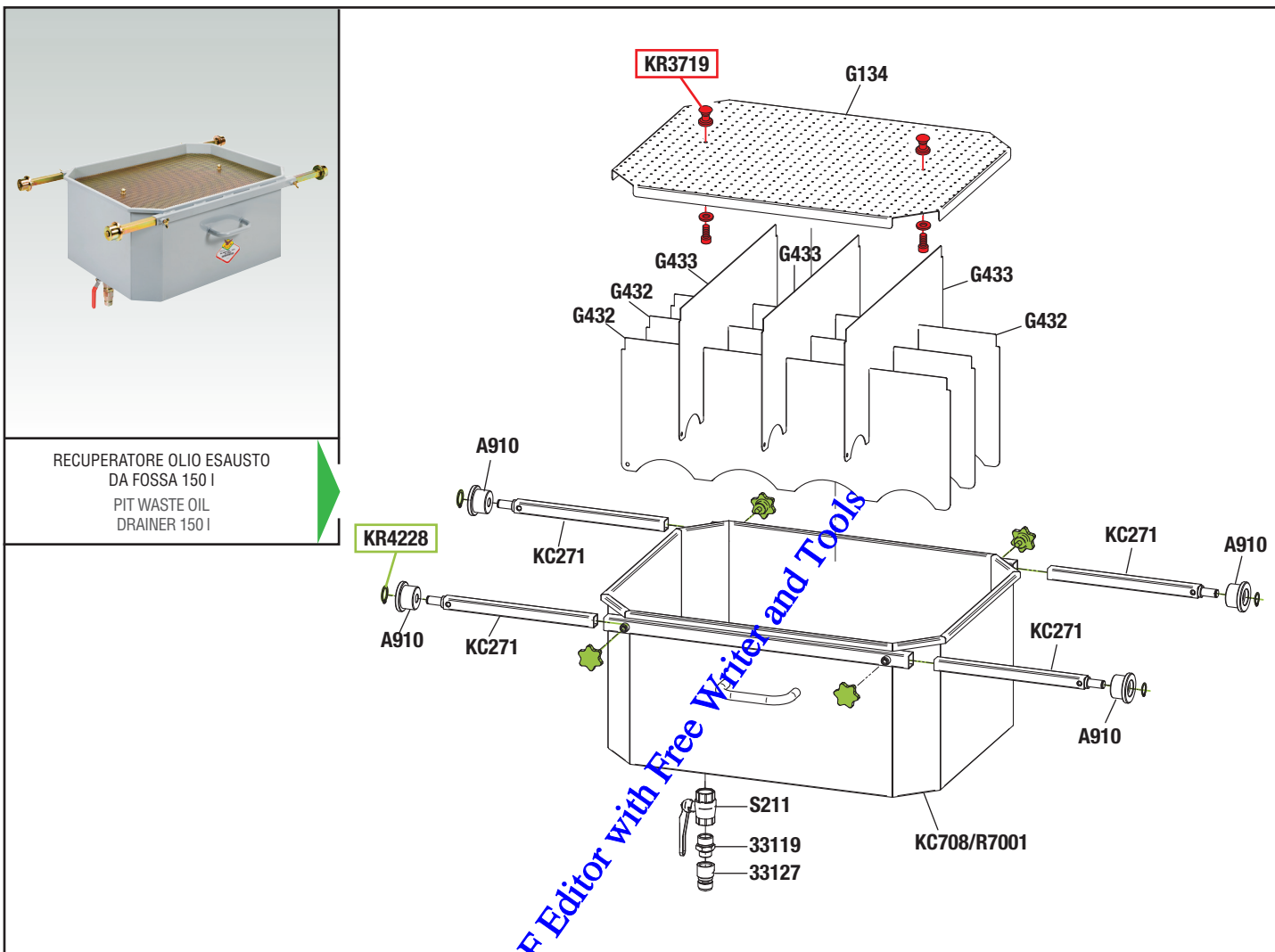

RECUPERATORE OLIO ESAUSTO
DA FOSSA 150 l
PIT WASTE OIL
DRAINER 150l

GUIDA RICAMBI - SPARE PARTS GUIDE

KIT RICAMBI
OGNI KIT SOTTO RIPORTATO COMPRENDE I RICAMBI EVIDENZIATI CON LO STESSO COLORE E LE RELATIVE GUARNIZIONI. QUESTI RICAMBI NON SONO FORNIBILI SEPARATAMENTE TRanne QUELLI CODIFICATI.

SPARE PARTS KITS
EACH KIT SHOWN WITH THE SAME COLOR INCLUDES ALSO THE GASKETS. THE SPARE PARTS INCLUDED IN THE KIT CAN'T BE SUPPLIED SEPARATELY EXCEPT THOSE SHOWN WITH A PROPER CODE.

CODICE CODE	DESCRIZIONE DESCRIPTION	Q.TÀ QTY
KR3719	VITERIA FISSAGGIO LAMIERA FORATA SCREWS	1
KR4228	VITERIA FISSAGGIO ASTA PORTA RUOTA SCREWS	1

ELENCO RICAMBI FORNIBILI SINGOLARMENTE
LIST OF SPARE PARTS WHICH CAN BE SUPPLIED SEPARATELY

CODICE CODE	DESCRIZIONE DESCRIPTION	Q.TÀ QTY
33119	NIPPLE M 1" G x M 3/4" G NIPPLE M 1" G x M 3/4" G	1
33127	ATTACCO RAPIDO MASCHIO MALE QUICK CONNECTION	1
A910	RUOTA PER VASCA WHEELS TANK	4
G134	GRIGLIA NET	1
G432	FRANGIFLUTTO SPLASH RETAINER	3
G433	FRANGIFLUTTO SPLASH RETAINER	3
KC271	ASTA PORTA RUOTA WHEEL SHAFT	4
KC708/R7001	VASCA TANK	1
S211	RUBINETTO A SFERA 1" BALL VALVE 1"	1

tutti i diritti riservati - all rights reserved



Art. 42056 Mod. RO.150LF



VISTA ESPLOSA - EXPLODED VIEW



RECUPERATORE OLIO ESAUSTO
DA FOSSA 150 I
PIT WASTE OIL
DRAINER 150 I

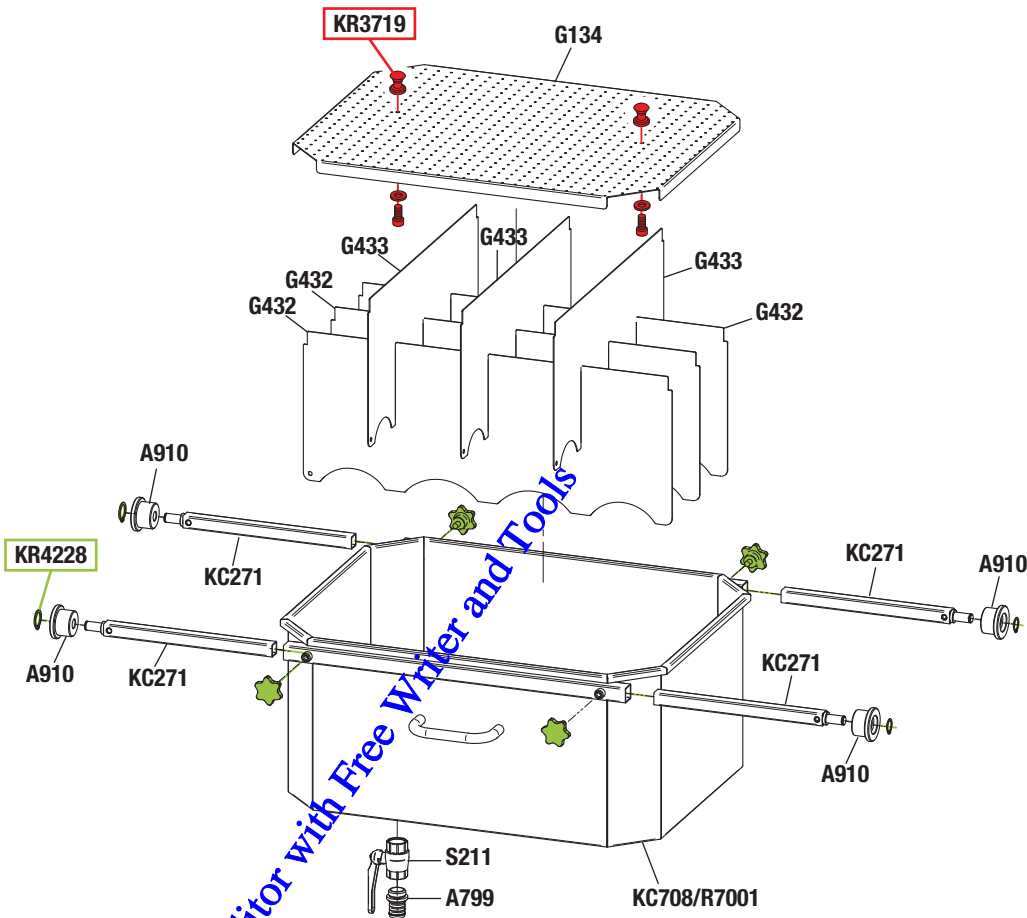

tutti i diritti riservati - all rights reserved

GUIDA RICAMBI - SPARE PARTS GUIDE

KIT RICAMBI
OGNI KIT SOTTO RIPORTATO COMPRENDE I RICAMBI EVIDENZIATI CON LO STESSO COLORE E LE RELATIVE GUARNIZIONI. QUESTI RICAMBI NON SONO FORNIBILI SEPARATAMENTE TRAMIE QUELLI CODIFICATI.

SPARE PARTS KITS
EACH KIT SHOWN WITH THE SAME COLOR INCLUDES ALSO THE GASKETS. THE SPARE PARTS INCLUDED IN THE KIT CAN'T BE SUPPLIED SEPARATELY EXCEPT THOSE SHOWN WITH A PROPER CODE.

CODICE CODE	DESCRIZIONE DESCRIPTION	Q.TÀ QTY
KR3719	VITERIA FISSAGGIO LAMIERA FORATA SCREWS	1
KR4228	VITERIA FISSAGGIO ASTA PORTA RUOTA SCREWS	1

ELENCO RICAMBI FORNIBILI SINGOLARMENTE
LIST OF SPARE PARTS WHICH CAN BE SUPPLIED SEPARATELY

CODICE CODE	DESCRIZIONE DESCRIPTION	Q.TÀ QTY
A799	PORTATUBO A RESCA HOSE HOLDER	1
A910	RUOTA PER VASCA WHEELS TANK	4
G134	GRIGLIA NET	1
G432	FRANGIFLUTTO SPLASH RETAINER	3
G433	FRANGIFLUTTO SPLASH RETAINER	3
KC271	ASTA PORTA RUOTA WHEEL SHAFT	4
KC708/R7001	VASCA TANK	1
S211	RUBINETTO A SFERA 1" BALL VALVE 1"	1



Art. 42059 Mod. RO.60LF - Art. 42060 Mod. RO.60LF

VISTA ESPLOSA - EXPLODED VIEW



RECUPERATORE OLIO ESAUSTO DA FOSSA 65 l
PIT WASTE OIL DRAINER 65 l

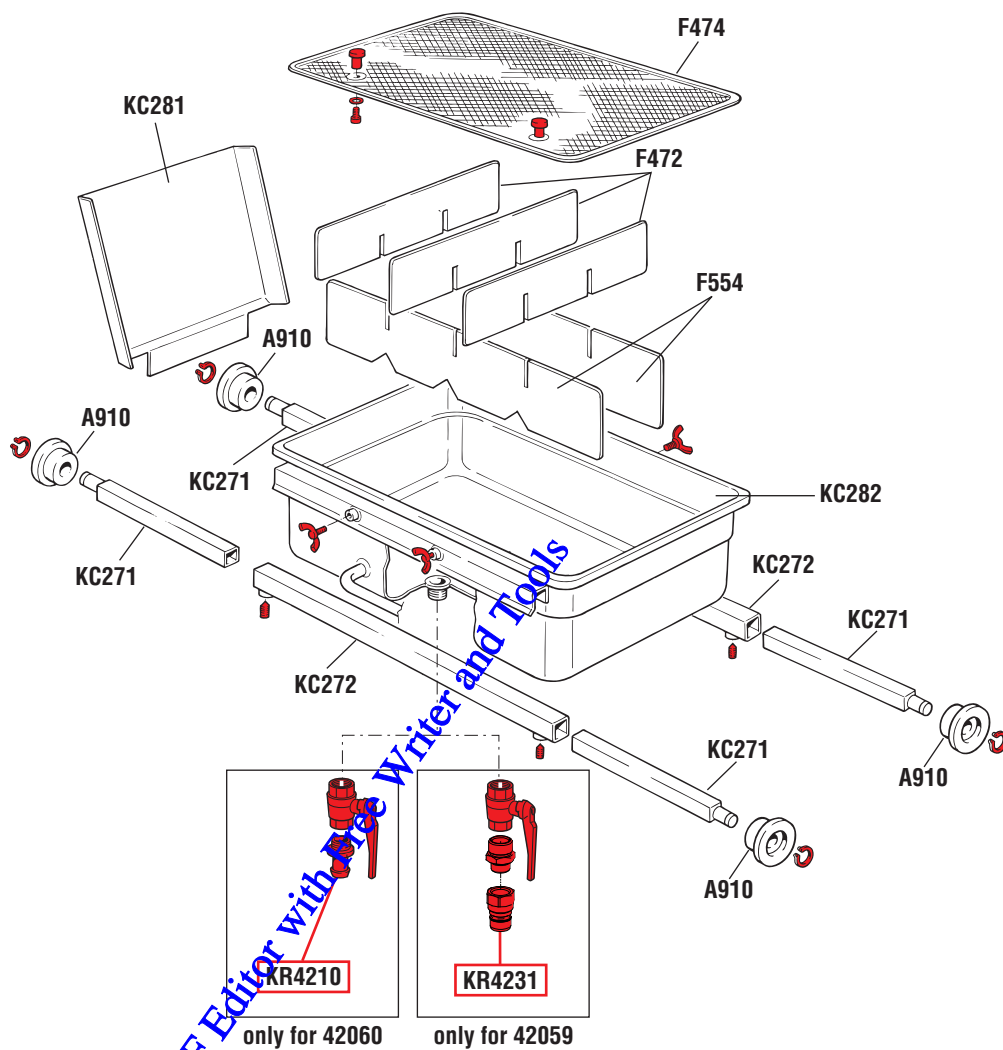

tutti i diritti riservati - all rights reserved

GUIDA RICAMBI - SPARE PARTS GUIDE

KIT RICAMBI
OGNI KIT SOTTO RIPORTATO COMPRENDE I RICAMBI EVIDENZIATI CON LO STESSO COLORE E LE RELATIVE GUARNIZIONI. QUESTI RICAMBI NON SONO FORNIBILI SEPARATAMENTE TRAMIE QUELLI CODIFICATI.

SPARE PARTS KITS
EACH KIT SHOWN WITH THE SAME COLOR INCLUDES ALSO THE GASKETS. THE SPARE PARTS INCLUDED IN THE KIT CAN'T BE SUPPLIED SEPARATELY EXCEPT THOSE SHOWN WITH A PROPER CODE.

CODICE CODE	DESCRIZIONE DESCRIPTION	Q.TÀ QTY
KR4210	ACCESSORI VASCA DA FOSSA PIT TANK ACCESSORIES	1
KR4231	ACCESSORI VASCA DA FOSSA PIT TANK ACCESSORIES	1

ELENCO RICAMBI FORNIBILI SINGOLARMENTE
LIST OF SPARE PARTS WHICH CAN BE SUPPLIED SEPARATELY

CODICE CODE	DESCRIZIONE DESCRIPTION	Q.TÀ QTY
A910	RUOTA PER VASCA WHEELS TANK	4
F472	FRANGIFLUTTO SPLASH RETAINER	3
F474	GRIGLIA NET	1
F554	FRANGIFLUTTO SPLASH RETAINER	2
KC271	ASTA PORTA RUOTA WHEEL SHAFT	4
KC272	ASTA DI REGOLAZIONE ADJUSTMENT ROD	2
KC281	CONVOGLIATORE OLIO OIL CHUTE	1
KC282	VASCA DA FOSSA PIT TANK	1



Art. 42061 Mod. RO.110LF - Art. 42062 Mod. RO.110LF

VISTA ESPLOSA - EXPLODED VIEW

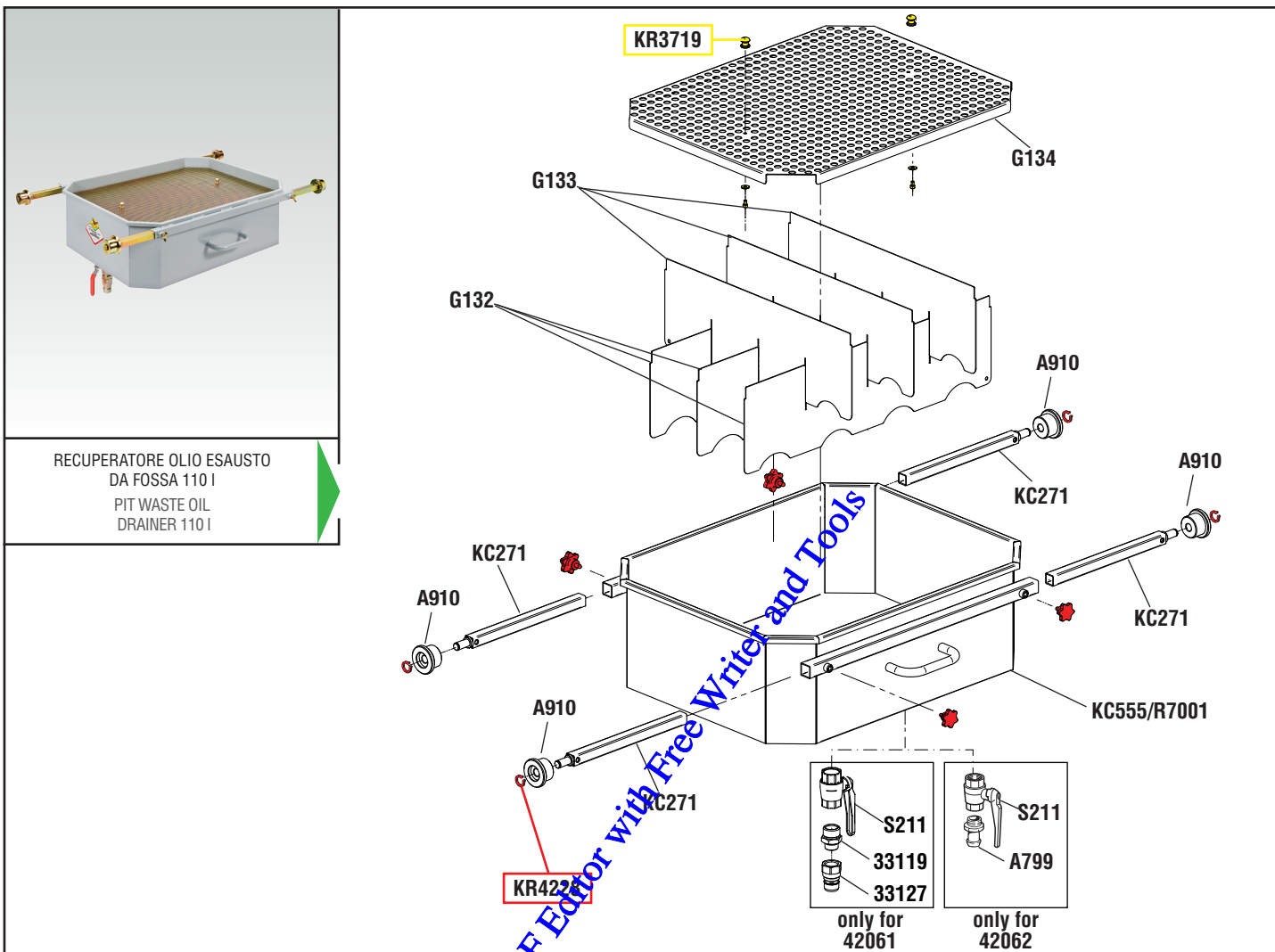

RECUPERATORE OLIO ESAUSTO DA FOSSA 110 l
PIT WASTE OIL DRAINER 110l



GUIDA RICAMBI - SPARE PARTS GUIDE

KIT RICAMBI
OGNI KIT SOTTO RIPORTATO COMPRENDE I RICAMBI EVIDENZIATI CON LO STESSO COLORE E LE RELATIVE GUARNIZIONI. QUESTI RICAMBI NON SONO FORNIBILI SEPARATAMENTE TRAMIE QUELLI CODIFICATI.

SPARE PARTS KITS
EACH KIT SHOWN WITH THE SAME COLOR INCLUDES ALSO THE GASKETS. THE SPARE PARTS INCLUDED IN THE KIT CAN'T BE SUPPLIED SEPARATELY EXCEPT THOSE SHOWN WITH A PROPER CODE.

CODICE CODE	DESCRIZIONE DESCRIPTION	Q.TÀ QTY
KR3719	VITERIA FISSAGGIO LAMIERA FORATA SCREWS	1
KR4228	VITERIA FISSAGGIO ASTA PORTA RUOTA SCREWS	1

ELENCO RICAMBI FORNIBILI SINGOLARMENTE
LIST OF SPARE PARTS WHICH CAN BE SUPPLIED SEPARATELY

CODICE CODE	DESCRIZIONE DESCRIPTION	Q.TÀ QTY
A799	PORTATUBO A RESCA HOSE HOLDER	1
A910	RUOTA PER VASCA WHEELS TANK	4
G132	FRANGIFLUTTO SPLASH RETAINER	3
G133	FRANGIFLUTTO SPLASH RETAINER	3
G134	GRIGLIA NET	1
KC271	ASTA PORTA RUOTA WHEEL SHAFT	4
KC555/R7001	VASCA FOSSA PIT TANK	1
S211	RUBINETTO A SFERA 1" BALL VALVE 1"	1
33119	NIPPLE M 1" G x M 3/4" G NIPPLE M 1" G x M 3/4" G	1
33127	ATTACCO RAPIDO MASCHIO MALE QUICK CONNECTION	1

tutti i diritti riservati - all rights reserved



Art. 42063 Mod. RO.65L - Art. 42064 Mod. RO.65 I

VISTA ESPLOSA - EXPLODED VIEW

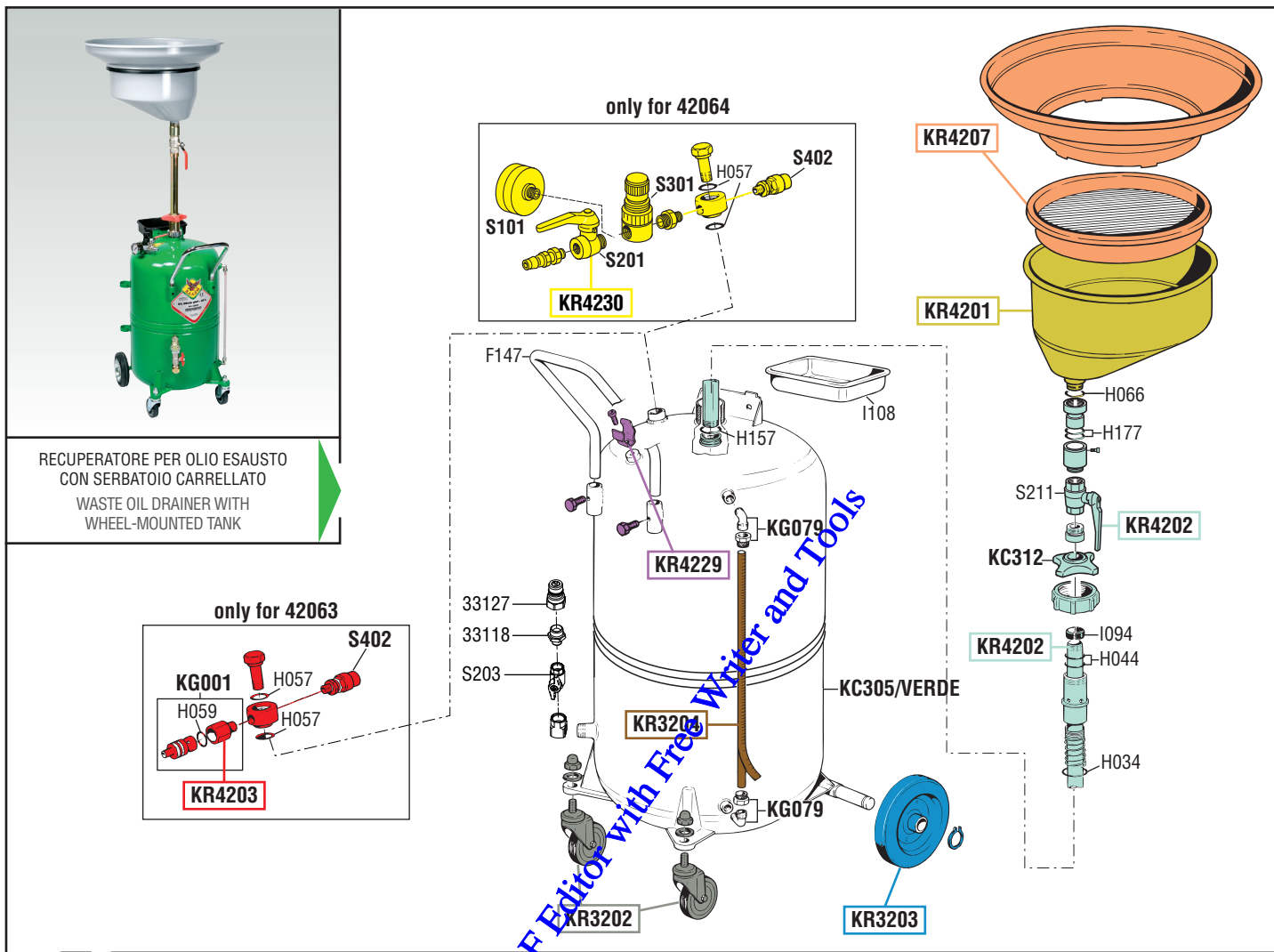

RECUPERATORE PER OLIO ESAUSTO
CON SERBATOIO CARRELLATO
WASTE OIL DRAINER WITH
WHEEL-MOUNTED TANK

only for 42063

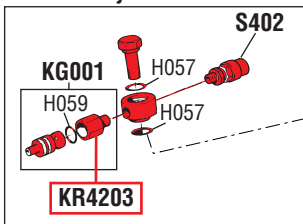

only for 42064

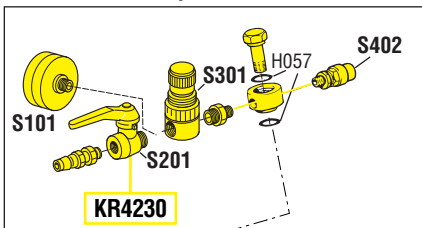

GUIDA RICAMBI - SPARE PARTS GUIDE

KIT RICAMBI

OGNI KIT SOTTO RIPORTATO COMPRENDE I RICAMBI EVIDENZIATI CON LO STESSO COLORE E LE RELATIVE GUARNIZIONI. QUESTI RICAMBI NON SONO FORNIBILI SEPARATAMENTE TRANNE QUELLI CODIFICATI.

SPARE PARTS KITS

EACH KIT SHOWN WITH THE SAME COLOR INCLUDES ALSO THE GASKETS. THE SPARE PARTS INCLUDED IN THE KIT CAN'T BE SUPPLIED SEPARATELY EXCEPT THOSE SHOWN WITH A PROPER CODE.

CODICE CODE	DESCRIZIONE DESCRIPTION	Q.TÀ QTY
KR3202	DUE RUOTE PIROETTANTI CON DADI TWO SWIVELLING WHEELS WITH NUTS	1
KR3203	2 RUOTE Fisse CON ANELLI ELASTICI 2 FIXED WHEELS WITH RETAINING RINGS	1
KR3204	TUBO DI LIVELLO ED ETICHETTA GAUGE TUBE AND LABEL	1
KR4201	COPPA RACCOGLI OLIO OIL COLLECTING BOWL	1
KR4202	GRUPPO COLLEGAMENTO CONNECTING GROUP	1
KR4203	GRUPPO RUBINETTO-VALVOLA DI SICUREZZA AIR TAP AND SAFETY VALVE GROUP	1
KR4229	SET DI VITI PER SERBATOIO SET OF SCREWS FOR RESERVOIR	1
KR4230	GR. RUBINETTO CON REG. PRESSIONE AIR TAP GROUP WITH PRESSURE REGULATOR	1

ELENCO RICAMBI FORNIBILI SINGOLARMENTE

LIST OF SPARE PARTS WHICH CAN BE SUPPLIED SEPARATELY

CODICE CODE	DESCRIZIONE DESCRIPTION	Q.TÀ QTY
33118	NIPPLE M 1/2" G x M 3/4" G NIPPLE M 1/2" G x M 3/4" G	1
33127	ATTACCO RAPIDO MASCHIO MALE QUICK CONNECTION	1
F147	MANICO A "U" HANDLE	1
I108	VASCHETTA PORTA OGGETTI TOOL TRAY	1
KC305/VERDE	SERBATOIO 65 l RESERVOIR 65 l	1
KC312	GHIERA IRON RING	1
KG001	RUBINETTO UNIVERSALE CARICA ARIA UNIVERSAL AIR TAP	1
KG079	GRUPPO GOMITO E GHIERA RING AND ELBOW JOINT GROUP	2
S101	MANOMETRO ø 50 mm GAUGE ø 50 mm	1
S201	RUBINETTO A SFERA 1/4" BALL VALVE 1/4"	1
S211	RUBINETTO A SFERA 1" BALL VALVE 1"	1
S203	RUBINETTO A SFERA 1/2" BALL VALVE 1/2"	1
S301	REGOLATORE DI PRESSIONE 1/4" PRESSURE REGULATOR 1/4"	1
S402	VALVOLA DI SICUREZZA 1 bar SAFETY VALVE 1 bar	1

Art. KR4250

KIT GUARNIZIONI COMPLETO

COMPOSTO DALLE GUARNIZIONI SOTTO ELENCAE
JOINTS GASKETS LIST
INCLUDING ALL THE GASKETS SHOWN HERE UNDER

CODICE CODE	DESCRIZIONE DESCRIPTION	Q.TÀ QTY
H034	O-RING 3156 O-RING 3156	1
H044	O-RING 4137 O-RING 4137	2
H057	O-RING 2062 O-RING 2062	2
H059	O-RING 2037 O-RING 2037	1
H064	O-RING 3043 O-RING 3043	2
H066	O-RING 3118 O-RING 3118	1
H157	O-RING 3137 "VITON" O-RING 3137 "VITON"	1
H177	O-RING 4131 O-RING 4131	2
I094	OGIVA STRINGI TUBO CLAMPING TUBE OGIVE	1

tutti i diritti riservati - all rights reserved



Art. 42065 Mod. RO.65L



VISTA ESPLOSA - EXPLODED VIEW

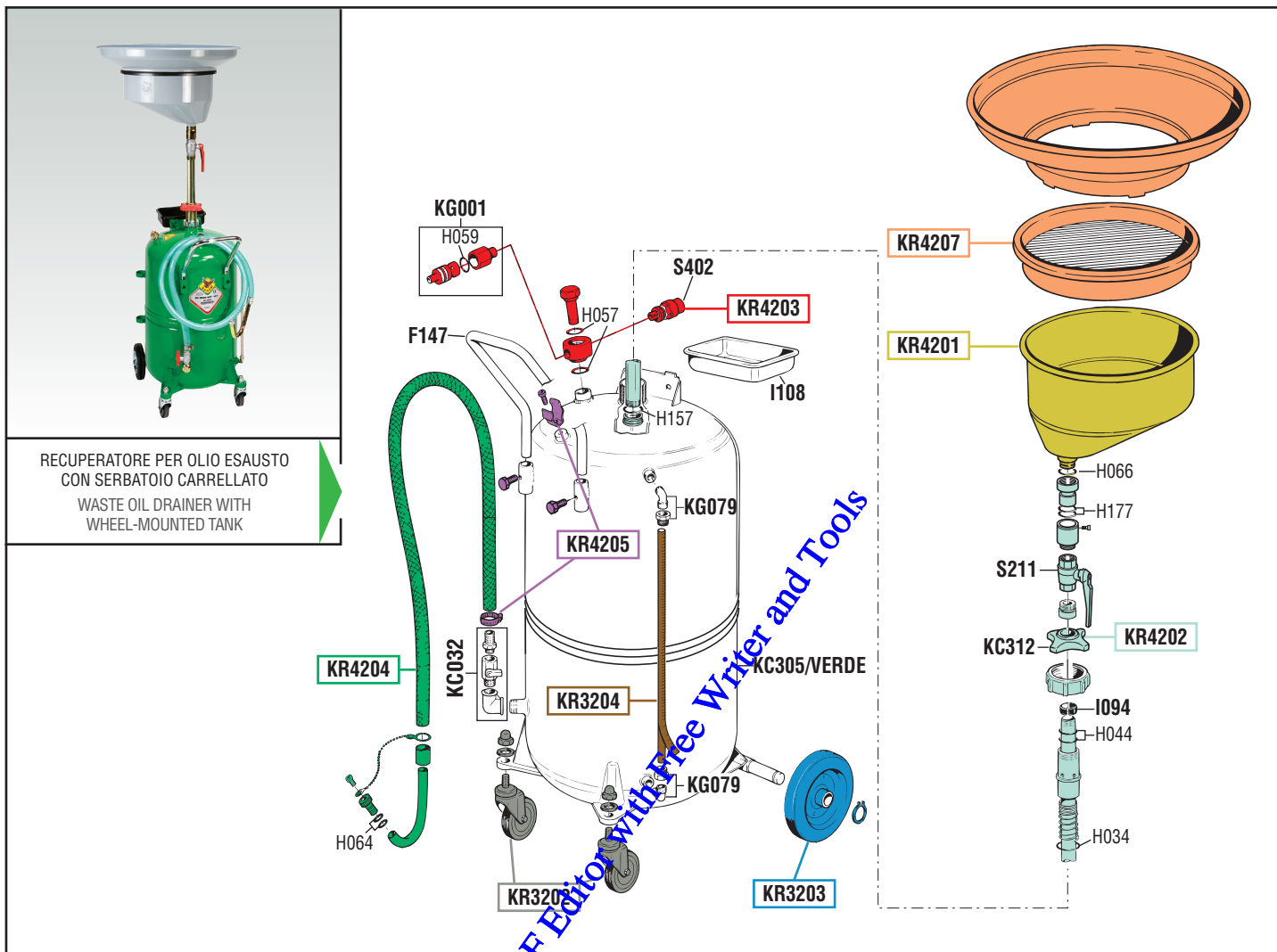

RECUPERATORE PER OLIO ESAUSTO
CON SERBATOIO CARRELLATO
WASTE OIL DRAINER WITH
WHEEL-MOUNTED TANK

GUIDA RICAMBI - SPARE PARTS GUIDE

KIT RICAMBI
OGNI KIT SOTTO RIPORTATO COMPRENDE I RICAMBI EVIDENZIATI CON LO STESSO COLORE E LE RELATIVE GUARNIZIONI. QUESTI RICAMBI NON SONO FORNIBILI SEPARATAMENTE TRANNE QUELLI CODIFICATI.

SPARE PARTS KITS
EACH KIT SHOWN WITH THE SAME COLOR INCLUDES ALSO THE GASKETS. THE SPARE PARTS INCLUDED IN THE KIT CAN'T BE SUPPLIED SEPARATELY EXCEPT THOSE SHOWN WITH A PROPER CODE.

CODICE CODE	DESCRIZIONE DESCRIPTION	Q.TÀ QTY
KR3202	DUE RUOTE PIROETTANTI CON DADI TWO SWIVELLING WHEELS WITH NUTS	1
KR3203	2 RUOTE FISSE CON ANELLI ELASTICI 2 FIXED WHEELS WITH RETAINING RINGS	1
KR3204	TUBO DI LIVELLO ED ETICHETTA GAUGE TUBE AND LABEL	1
KR4201	COPPA RACCOGLI OLIO OIL COLLECTING BOWL	1
KR4202	GRUPPO COLLEGAMENTO CONNECTING GROUP	1
KR4203	GRUPPO RUBINETTO-VALVOLA DI SICUREZZA AIR TAP AND SAFETY VALVE GROUP	1
KR4204	TUBO SCARICO CON FASCETTA STRINGI TUBO DISCHARGING HOSE WITH HOSE CLAMP	1
KR4205	SET DI VITI PER SERBATOIO SET OF SCREWS FOR RESERVOIR	1
KR4207	IMBUTO CON GRIGLIA FUNNEL WITH NET	1

ELENCO RICAMBI FORNIBILI SINGOLARMENTE
LIST OF SPARE PARTS WHICH CAN BE SUPPLIED SEPARATELY

CODICE CODE	DESCRIZIONE DESCRIPTION	Q.TÀ QTY
F147	MANICO A "U" HANDLE	1
I108	VASCHETTA PORTA OGGETTI TOOL TRAY	1
KC032	GRUPPO SCARICO SERBATOIO DISCHARGING GROUP	1
KC305/VERDE	SERBATOIO 65 l RESERVOIR 65 l	1
KC312	GHIERA IRON RING	1
KG001	RUBINETTO UNIVERSALE CARICA ARIA UNIVERSAL AIR TAP	1
KG079	GRUPPO GOMITO E GHIERA RING AND ELBOW JOINT GROUP	2
S211	RUBINETTO A SFERA 1" BALL VALVE 1"	1
S402	VALVOLA DI SICUREZZA 1 bar SAFETY VALVE 1 bar	1

Art. KR4250
KIT GUARNIZIONI COMPLETO
COMPOSTO DALLE GUARNIZIONI SOTTO ELENCAE
JOINTS GASKETS LIST
INCLUDING ALL THE GASKETS SHOWN HERE UNDER

CODICE CODE	DESCRIZIONE DESCRIPTION	Q.TÀ QTY
H034	O-RING 3156 O-RING 3156	1
H044	O-RING 4137 O-RING 4137	2
H057	O-RING 2062 O-RING 2062	2
H059	O-RING 2037 O-RING 2037	1
H064	O-RING 3043 O-RING 3043	2
H066	O-RING 3118 O-RING 3118	1
H157	O-RING 3137 "VITON" O-RING 3137 "VITON"	1
H177	O-RING 4131 O-RING 4131	2
I094	OGIVA STRINGI TUBO CLAMPING TUBE OGIVE	1

Art. KS4280
SET RICAMBI CONSIGLIATI
AI PUNTI VENDITA E ASSISTENZA,
COMPOSTO DAI RICAMBI SOTTO ELENCAE
SPARE PARTS KIT ADVISED
TO THE REPAIR CENTERS. THIS KIT INCLUDES
ALL THE SPARE PARTS SHOWN HERE UNDER

CODICE CODE	DESCRIZIONE DESCRIPTION	Q.TÀ QTY
KR4204	TUBO SCARICO CON FASCETTA STRINGI TUBO DISCHARGING HOSE WITH HOSE CLAMP	1
KR4250	KIT GUARNIZIONI COMPLETO COMPLETE GASKETS KIT	1

tutti i diritti riservati - all rights reserved



Art. 42066 Mod. RO.C.65L

VISTA ESPLOSA - EXPLODED VIEW

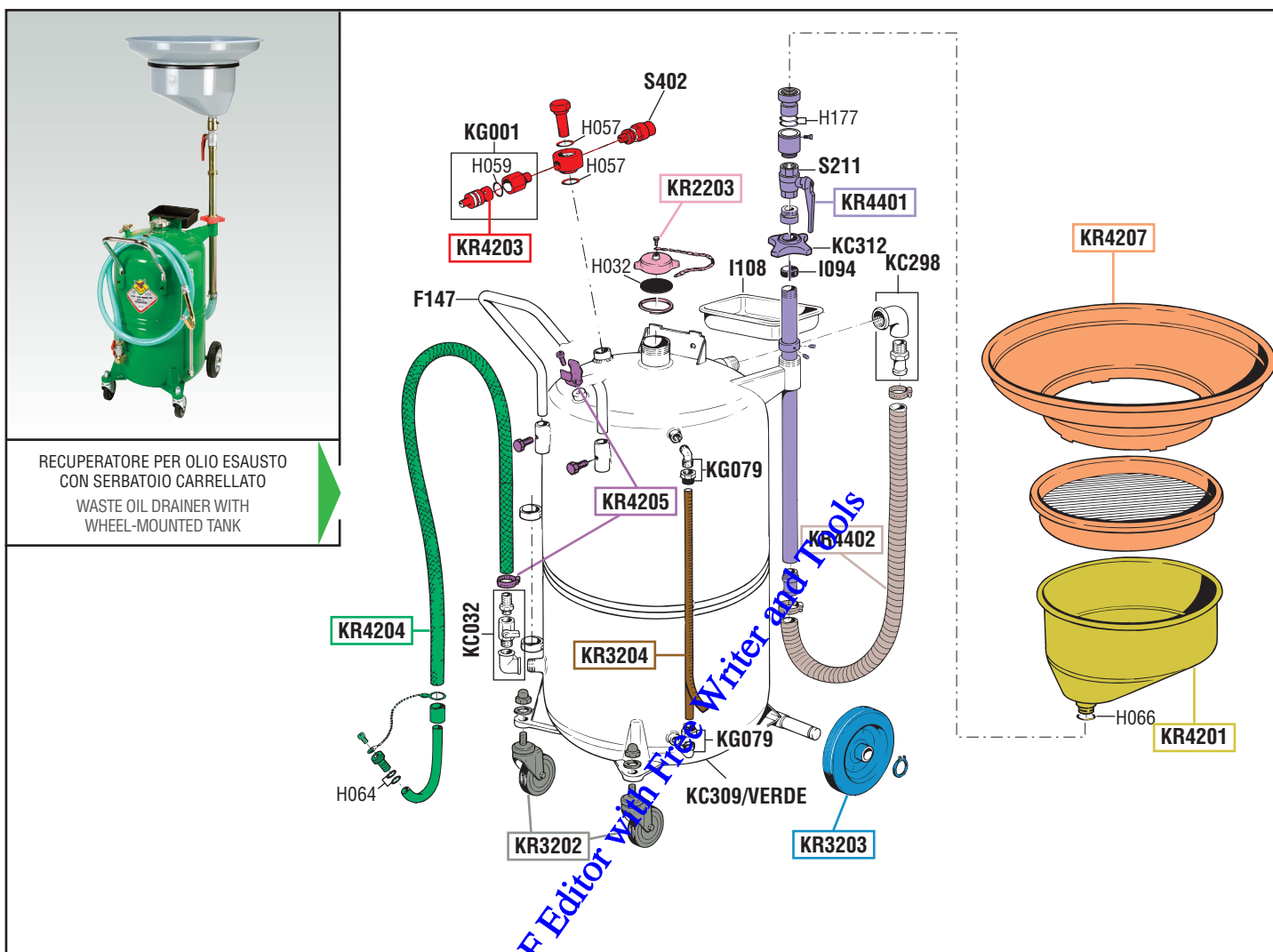

RECUPERATORE PER OLIO ESAUSTO
CON SERBATOIO CARRELLATO
WASTE OIL DRAINER WITH
WHEEL-MOUNTED TANK

tutti i diritti riservati - all rights reserved

GUIDA RICAMBI - SPARE PARTS GUIDE

KIT RICAMBI
OGNI KIT SOTTO RIPORTATO COMPRENDE I RICAMBI EVIDENZIATI CON LO STESSO COLORE E LE RELATIVE GUARNIZIONI. QUESTI RICAMBI NON SONO FORNIBILI SEPARATAMENTE TRANNE QUELLI CODIFICATI.
SPARE PARTS KITS
EACH KIT SHOWN WITH THE SAME COLOR INCLUDES ALSO THE GASKETS. THE SPARE PARTS INCLUDED IN THE KIT CAN'T BE SUPPLIED SEPARATELY EXCEPT THOSE SHOWN WITH A PROPER CODE.

CODICE CODE	DESCRIZIONE DESCRIPTION	Q.TÀ QTY
KR2203	TAPPO ALTA PRESSIONE HIGH PRESSURE PLUG	1
KR3202	DUE RUOTE PIROETTANTI CON DADI TWO SWIVELLING WHEELS WITH NUTS	1
KR3203	2 RUOTE FISSI CON ANELLI ELASTICI 2 FIXED WHEELS WITH RETAINING RINGS	1
KR3204	TUBO DI LIVELLO ED ETICHETTA GAUGE TUBE AND LABEL	1
KR4201	COPPA RACCOLTI OLIO OIL COLLECTING BOWL	1
KR4203	GRUPPO RUBINETTO-VALVOLA DI SICUREZZA AIR TAP AND SAFETY VALVE GROUP	1
KR4204	TUBO SCARICO CON FASCETTA STRINGI TUBO DISCHARGING HOSE WITH HOSE CLAMP	1
KR4205	SET DI VITI PER SERBATOIO SET OF SCREWS FOR RESERVOIR	1
KR4207	IMBUTO CON GRIGLIA FUNNEL WITH NET	1
KR4401	TUBO SUPPORTO COPPA BOWL SUPPORTING TUBE	1
KR4402	TUBO FLESSIBILE PER SERBATOIO 65 l CONNECTING HOSE FOR 65 l RESERVOIR	1

ELENCO RICAMBI FORNIBILI SINGOLARMENTE
LIST OF SPARE PARTS WHICH CAN BE SUPPLIED SEPARATELY

CODICE CODE	DESCRIZIONE DESCRIPTION	Q.TÀ QTY
F147	MANICO A "U" HANDLE	1
I108	VASCHETTA PORTA OGGETTI TOOL TRAY	1
KC032	GRUPPO SCARICO SERBATOIO DISCHARGING GROUP	1
KC298	GRUPPO SCARICO COPPA DISCHARGING GROUP	1
KC309/VERDE	SERBATOIO 65 l RESERVOIR 65 l	1
KC312	GHIERA IRON RING	1
KG001	RUBINETTO UNIVERSALE CARICA ARIA UNIVERSAL AIR TAP	1
KG079	GRUPPO GOMITO E GHIERA RING AND ELBOW JOINT GROUP	2
S211	RUBINETTO A SFERA 1" BALL VALVE 1"	1
S402	VALVOLA DI SICUREZZA 1 bar SAFETY VALVE 1 bar	1

Art. KR4252
KIT GUARNIZIONI COMPLETO
COMPOSTO DALLE GUARNIZIONI SOTTO ELENCAE
JOINTS GASKETS LIST
INCLUDING ALL THE GASKETS SHOWN HERE UNDER

CODICE CODE	DESCRIZIONE DESCRIPTION	Q.TÀ QTY
H032	GUARNIZIONE TAPPO GASKET	1
H057	O-RING 2062 O-RING 2062	2
H059	O-RING 2037 O-RING 2037	1
H064	O-RING 3043 O-RING 3043	2
H066	O-RING 3118 O-RING 3118	1
H177	O-RING 4131 O-RING 4131	2
I094	OGIVA STRINGI TUBO CLAMPING TUBE OGVIE	1

Art. KS4281
SET RICAMBI CONSIGLIATI
AI PUNTI VENDITA E ASSISTENZA,
COMPOSTO DAI RICAMBI SOTTO ELENCAE
SPARE PARTS KIT ADVISED
TO THE REPAIR CENTERS. THIS KIT INCLUDES
ALL THE SPARE PARTS SHOWN HERE UNDER

CODICE CODE	DESCRIZIONE DESCRIPTION	Q.TÀ QTY
KR4204	TUBO SCARICO CON FASCETTA STRINGI TUBO DISCHARGING HOSE WITH HOSE CLAMP	1
KR4252	KIT GUARNIZIONI COMPLETO COMPLETE GASKETS KIT	1
KR4402	TUBO FLESSIBILE PER SERBATOIO 65 l CONNECTING HOSE FOR 65 l RESERVOIR	1



Art. 42069 Mod. RO.50LP - Art. 42070 Mod. RO.50LP



VISTA ESPLOSA - EXPLODED VIEW

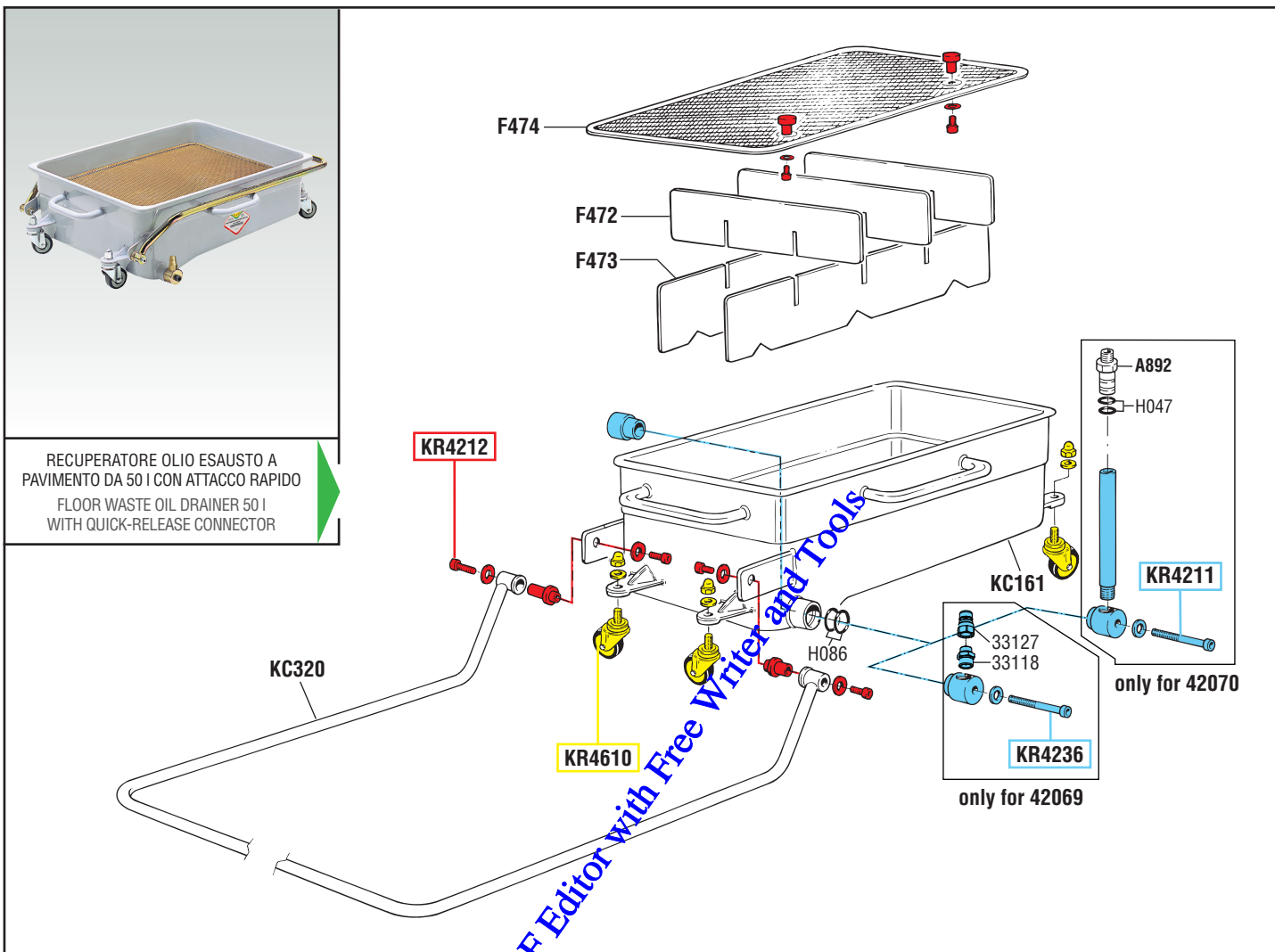

RECUPERATORE OLIO ESAUSTO A PAVIMENTO DA 50 l CON ATTACCO RAPIDO
FLOOR WASTE OIL DRAINER 50 l WITH QUICK-RELEASE CONNECTOR

KC320

KR4212

KR4610

KC161

KR4211

only for 42070

only for 42069

GUIDA RICAMBI - SPARE PARTS GUIDE

KIT RICAMBI

OGNI KIT SOTTO RIPORTATO COMPRENDE I RICAMBI EVIDENZIATI CON LO STESSO COLORE E LE RELATIVE GUARNIZIONI. QUESTI RICAMBI NON SONO FORNIBILI SEPARATAMENTE TRAMITE QUELLI CODIFICATI.

SPARE PARTS KITS

EACH KIT SHOWN WITH THE SAME COLOR INCLUDES ALSO THE GASKETS. THE SPARE PARTS INCLUDED IN THE KIT CAN'T BE SUPPLIED SEPARATELY EXCEPT THOSE SHOWN WITH A PROPER CODE.

CODICE CODE	DESCRIZIONE DESCRIPTION	Q.TÀ QTY
KR4211	ACCESSORI SCARICO DISCHARGING ACCESSORIES	1
KR4212	ACCESSORI ACCESSORIES	1
KR4236	ACCESSORI SCARICO DISCHARGING ACCESSORIES	1
KR4610	4 RUOTE PIROETTANTI ø 60 mm - DADI 4 SWIVELING WHEELS ø 60 mm - NUTS	1

ELENCO RICAMBI FORNIBILI SINGOLARMENTE

LIST OF SPARE PARTS WHICH CAN BE SUPPLIED SEPARATELY

CODICE CODE	DESCRIZIONE DESCRIPTION	Q.TÀ QTY
33118	NIPPLE M 1/2" G x M 3/4" G NIPPLE M 1/2" G x M 3/4" G	1
33127	ATTACCO RAPIDO MASCHIO MALE QUICK CONNECTION	1
A892	RACCORDO CONNECTION	1
F472	FRANGIFLUTTO SPLASH RETAINER	3
F473	FRANGIFLUTTO SPLASH RETAINER	2
F474	GRIGLIA NET	1
H047	O-RING 2050	2
H086	O-RING 4118	2
KC161	COPPA RACCOLGLI OLIO COLLECTING BASIN	1
KC320	MANICO MOBILE MOVABLE HANDLE	1

tutti i diritti riservati - all rights reserved



Art. 42072 Mod. RO.95LP - Art. 42073 Mod. RO.95LFP

VISTA ESPLOSA - EXPLODED VIEW

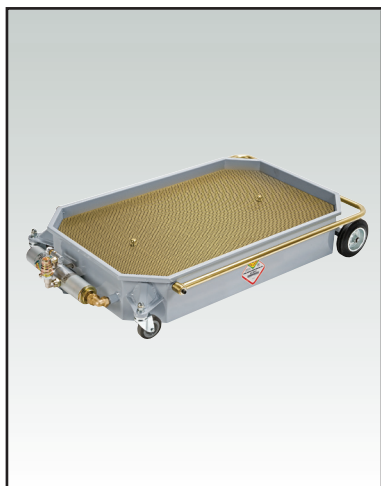

RECUPERATORE OLIO ESAUSTO A PAVIMENTO DA 95 L CON ATTACCO RAPIDO
FLOOR WASTE OIL DRAINER 95 L WITH QUICK-RELEASE CONNECTOR

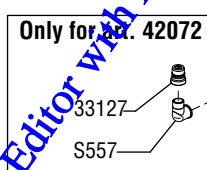
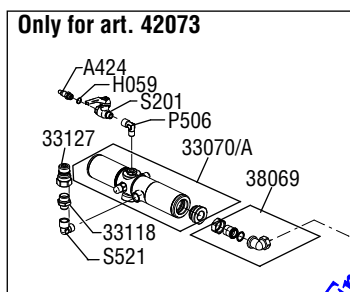
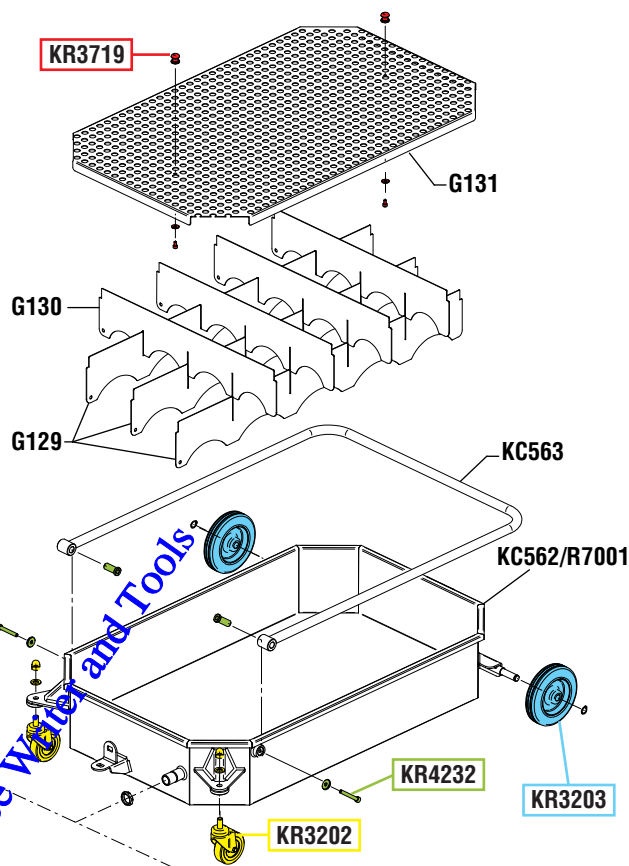

tutti i diritti riservati - all rights reserved

GUIDA RICAMBI - SPARE PARTS GUIDE

KIT RICAMBI
OGNI KIT SOTTO RIPORTATO COMPRENDE I RICAMBI EVIDENZIATI CON LO STESSO COLORE E LE RELATIVE GUARNIZIONI. QUESTI RICAMBI NON SONO FORNIBILI SEPARATAMENTE TRAMIE QUELLI CODIFICATI.

SPARE PARTS KITS
EACH KIT SHOWN WITH THE SAME COLOR INCLUDES ALSO THE GASKETS. THE SPARE PARTS INCLUDED IN THE KIT CAN'T BE SUPPLIED SEPARATELY EXCEPT THOSE SHOWN WITH A PROPER CODE.

CODICE CODE	DESCRIZIONE DESCRIPTION	Q.TÀ QTY
KR3202	2 RUOTE PIROETTANTI CON DADI 2 SWIVELING WHEELS WITH NUTS	1
KR3203	2 RUOTE FISSE CON ANELLI ELASTICI 2 FIXED WHEELS WITH RETAINING RINGS	1
KR3719	VITERIA FISSAGGIO LAMIERA FORATA SCREWS	1
KR4232	SET DI VITI SET OF SCREWS	1

ELENCO RICAMBI FORNIBILI SINGOLARMENTE
LIST OF SPARE PARTS WHICH CAN BE SUPPLIED SEPARATELY

CODICE CODE	DESCRIZIONE DESCRIPTION	Q.TÀ QTY
33070/A	POMPA DA TRAVASO R 1:1 TRANSFER PUMP R 1:1	1
33118	NIPPLE M 1/2" G x M 3/4" G NIPPLE M 1/2" G x M 3/4" G	1
33127	ATTACCO RAPIDO MASCHIO MALE QUICK CONNECTION	1
38069	BOCCHETTONE 90° CONNECTION 90°	1
A424	ATTACCO RAPIDO QUICK CONNECTION	1
G129	FRANGIFLUTTO SPASH RETAINER	3
G130	FRANGIFLUTTO SPASH RETAINER	4
G131	GRIGLIA NET	1
H059	O-RING 2037 O-RING 2037	1
KC562/R7001	VASCA RECUPERATORE FLOOR DRAINER TANK	1
KC563	MANICO MOBILE MOVABLE HANDLE	1
P506	RACCORDO CONNECTION	1
S201	RUBINETTO A SFERA 1/4" BALL VALVE 1/4"	1
S521	GOMITO M/F 1/2" G ELBOW M/F 1/2" G	1
S557	RACCORDO CURVO M/F 3/4" G CONNECTION M/F 3/4" G	1

PER I KIT RICAMBI DELL' Art. 33070/A VEDERE I RELATIVI ESPLOSI
FOR THE SPARE PARTS KITS OF Art. 33070/A PLEASE REFER TO PERTINENT EXPLODED VIEWS



Art. 42075 Mod. RO.150LP



VISTA ESPLOSA - EXPLODED VIEW



RECUPERATORE OLIO ESAUSTO
DA FOSSA
PIT WASTE OIL
DRAINER

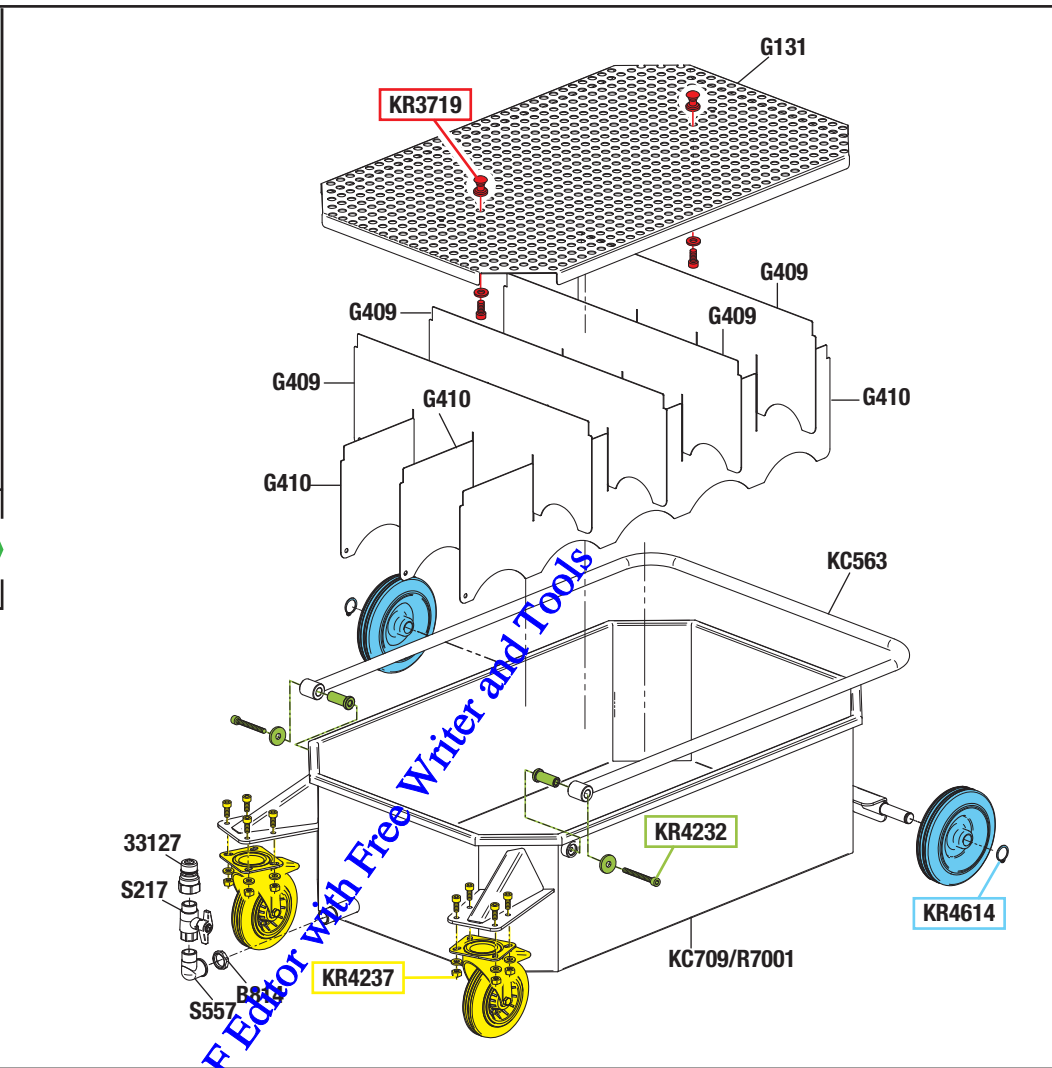

tutti i diritti riservati - all rights reserved

GUIDA RICAMBI - SPARE PARTS GUIDE

KIT RICAMBI
OGNI KIT SOTTO RIPORTATO COMPRENDE I RICAMBI EVIDENZIATI CON LO STESSO COLORE E LE RELATIVE GUARNIZIONI. QUESTI RICAMBI NON SONO FORNIBILI SEPARATAMENTE TRanne QUELLI CODIFICATI.

SPARE PARTS KITS
EACH KIT SHOWN WITH THE SAME COLOR INCLUDES ALSO THE GASKETS. THE SPARE PARTS INCLUDED IN THE KIT CAN'T BE SUPPLIED SEPARATELY EXCEPT THOSE SHOWN WITH A PROPER CODE.

CODICE CODE	DESCRIZIONE DESCRIPTION	Q.TÀ QTY
KR3719	VITERIA FISSAGGIO LAMIERA FORATA SCREWS	1
KR4232	SET DI VITI SET OF SCREWS	1
KR4237	2 RUOTE PIROETTANTI CON DADI 2 SWIVELING WHEELS WITH NUTS	1
KR4614	2 RUOTE FISSE CON ANELLI ELASTICI 2 FIXED WHEELS WITH RETAINING RINGS	1

ELENCO RICAMBI FORNIBILI SINGOLARMENTE
LIST OF SPARE PARTS WHICH CAN BE SUPPLIED SEPARATELY

CODICE CODE	DESCRIZIONE DESCRIPTION	Q.TÀ QTY
33127	ATTACCO RAPIDO MASCHIO MALE QUICK CONNECTION	1
B814	DADO NUT	1
G131	GRIGLIA NET	1
G409	FRANGIFLUTTO SPLASH RETAINER	4
G410	FRANGIFLUTTO SPLASH RETAINER	3
KC563	MANICO MOBILE MOVABLE HANDLE	1
KC709/R7001	VASCA TANK	1
S217	RUBINETTO A SFERA 3/4" BALL VALVE 3/4"	1
S557	RACCORDO CURVO M/F 3/4"G CONNECTION M/F 3/4"G	1



Art. 42076 Mod. RO.150LP



VISTA ESPLOSA - EXPLODED VIEW

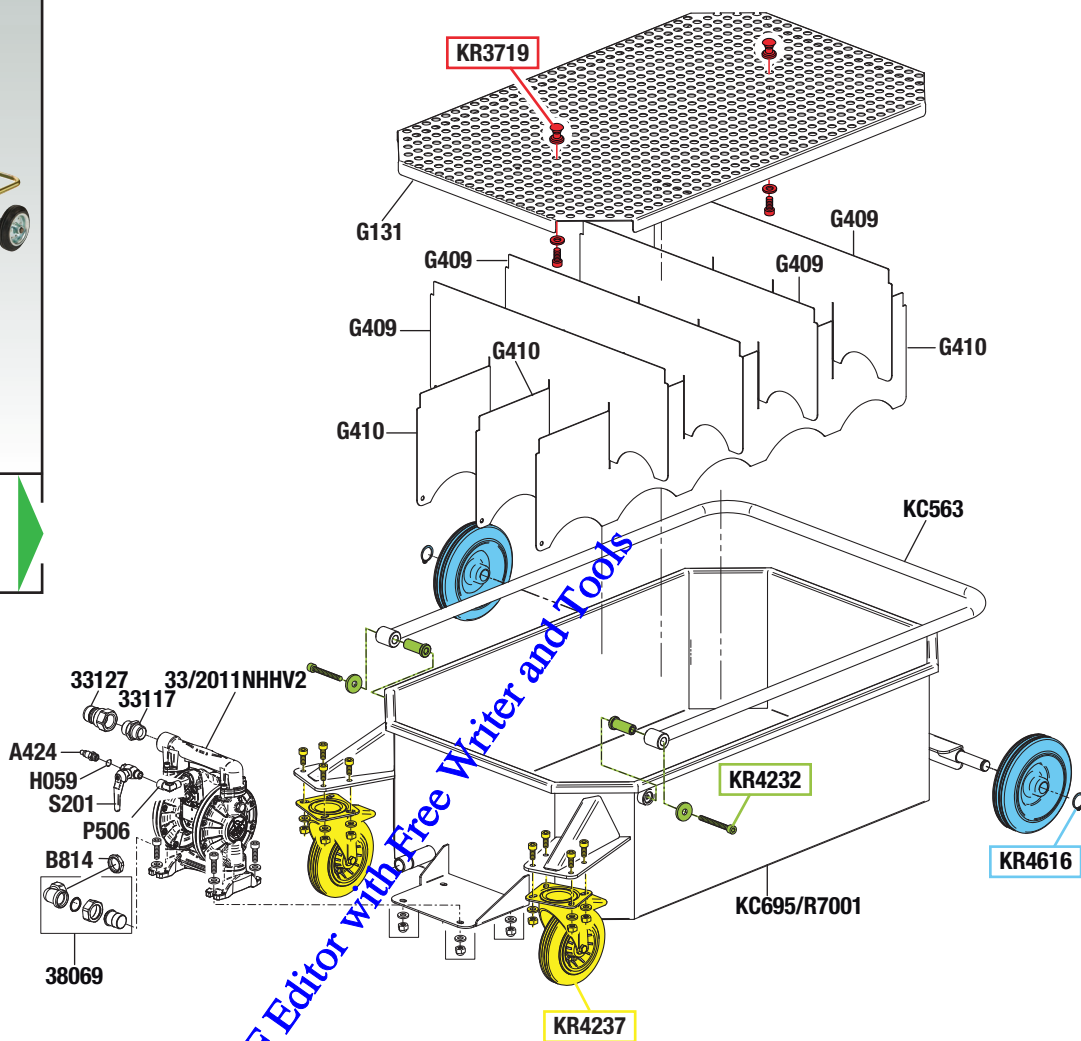
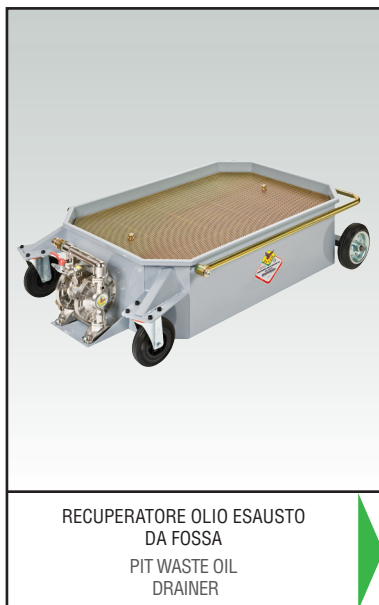

GUIDA RICAMBI - SPARE PARTS GUIDE

KIT RICAMBI

OGNI KIT SOTTO RIPORTATO COMPRENDE I RICAMBI EVIDENZIATI CON LO STESSO COLORE E LE RELATIVE GUARNIZIONI. QUESTI RICAMBI NON SONO FORNIBILI SEPARATAMENTE TRAMIE QUELLI CODIFICATI.

SPARE PARTS KITS

EACH KIT SHOWN WITH THE SAME COLOR INCLUDES ALSO THE GASKETS. THE SPARE PARTS INCLUDED IN THE KIT CAN'T BE SUPPLIED SEPARATELY EXCEPT THOSE SHOWN WITH A PROPER CODE.

CODICE CODE	DESCRIZIONE DESCRIPTION	Q.TÀ QTY
KR3719	VITERIA FISSAGGIO LAMIERA FORATA SCREWS	1
KR4232	SET DI VITI SET OF SCREWS	1
KR4237	2 RUOTE PIROETTANTI CON DADI 2 SWIVELING WHEELS WITH NUTS	1
KR4616	2 RUOTE FISSE CON ANELLI ELASTICI 2 FIXED WHEELS WITH RETAINING RINGS	1

ELENCO RICAMBI FORNIBILI SINGOLARMENTE

LIST OF SPARE PARTS WHICH CAN BE SUPPLIED SEPARATELY

CODICE CODE	DESCRIZIONE DESCRIPTION	Q.TÀ QTY
33/2011NHHV2	POMPA A DIAFRAMMA S. 3/4" DIAPHRAGM PUMP S. 3/4"	1
33117	NIPPLE M 3/4" G x M 3/4" G NIPPLE M 3/4" G x M 3/4" G	1
33127	ATTACCO RAPIDO MASCHIO MALE QUICK CONNECTION	1
38069	BOCCHETTONE 90° CONNECTION 90°	1
A424	ATTACCO RAPIDO QUICK CONNECTION	1
B814	DADO NUT	1
G131	GRIGLIA NET	1
G409	FRANGIFLUTTO SPASH RETAINER	4
G410	FRANGIFLUTTO SPASH RETAINER	3
H059	O-RING 2037 O-RING 2037	1
KC563	MANICO MOBILE MOVABLE HANDLE	1
KC695/R7001	VASCA TANK	1
P506	RACCORDO CONNECTION	1
S201	RUBINETTO A SFERA 1/4" BALL VALVE 1/4"	1

PER I KIT RICAMBI DELL' Art. 33/2011NHHV2 VEDERE I RELATIVI ESPLOSI
FOR THE SPARE PARTS KITS OF Art. 33/2011NHHV2 PLEASE REFER TO PERTINENT EXPLODED VIEWS



Art. 42088 Mod. RO.90L - Art. 42089 Mod. RO.90L

VISTA ESPLOSA - EXPLODED VIEW

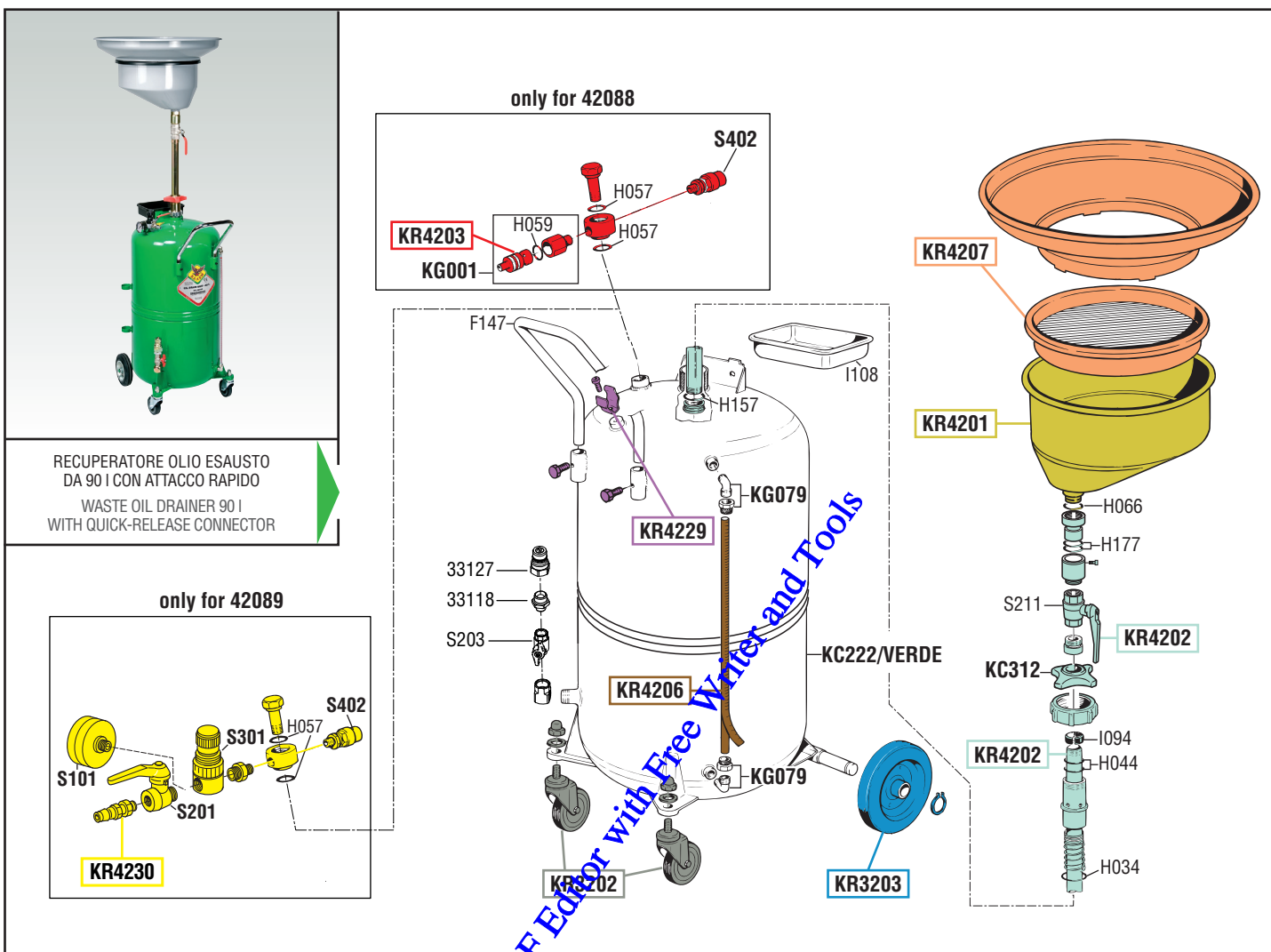

tutti i diritti riservati - all rights reserved

GUIDA RICAMBI - SPARE PARTS GUIDE

KIT RICAMBI
OGNI KIT SOTTO RIPORTATO COMPRENDE I RICAMBI EVIDENZIATI CON LO STESSO COLORE E LE RELATIVE GUARNIZIONI. QUESTI RICAMBI NON SONO FORNIBILI SEPARATAMENTE TRANNE QUELLI CODIFICATI.

SPARE PARTS KITS
EACH KIT SHOWN WITH THE SAME COLOR INCLUDES ALSO THE GASKETS. THE SPARE PARTS INCLUDED IN THE KIT CAN'T BE SUPPLIED SEPARATELY EXCEPT THOSE SHOWN WITH A PROPER CODE.

CODICE CODE	DESCRIZIONE DESCRIPTION	Q. TÀ QTY
KR3202	DUE RUOTE PIROETTANTI CON DADI TWO SWIVELLING WHEELS WITH NUTS	1
KR3203	2 RUOTE FISSE CON ANELLI ELASTICI 2 FIXED WHEELS WITH RETAINING RINGS	1
KR4201	COPPA RACCOGLI OLIO OIL COLLECTING BOWL	1
KR4202	GRUPPO COLLEGAMENTO CONNECTING GROUP	1
KR4203	GRUPPO RUBINETTO-VALVOLA DI SICUREZZA AIR TAP AND SAFETY VALVE GROUP	1
KR4229	SET DI VITI PER SERBATOIO SET OF SCREWS FOR RESERVOIR	1
KR4206	TUBO LIVELLO CON ETICHETTA GAUGE TUBE WITH LABEL	1
KR4230	GR. RUBINETTO CON REG. PRESSIONE AIR TAP GROUP WITH PRESSURE REGULATOR	1

ELENCO RICAMBI FORNIBILI SINGOLARMENTE
LIST OF SPARE PARTS WHICH CAN BE SUPPLIED SEPARATELY

CODICE CODE	DESCRIZIONE DESCRIPTION	Q. TÀ QTY
33118	NIPPLE M 1/2" G x M 3/4" G NIPPLE M 1/2" G x M 3/4" G	
33127	ATTACCO RAPIDO MASCHIO MALE QUICK CONNECTION	1
F147	MANICO A "U" HANDLE	1
I108	VASCHETTA PORTA OGGETTI TOOL TRAY	1
KC222/VERDE	SERBATOIO 90 L RESERVOIR 90 L	1
KC312	GHIERA IRON RING	1
KG001	RUBINETTO UNIVERSALE CARICA ARIA UNIVERSAL AIR TAP	1
KG079	GRUPPO GOMITO E GHIERA RING AND ELBOW JOINT GROUP	2
S101	MANOMETRO ø 50 mm GAUGE ø 50 mm	1
S201	RUBINETTO A SFERA 1/4" BALL VALVE 1/4"	1
S203	RUBINETTO A SFERA 1/2" BALL VALVE 1/2"	1
S211	RUBINETTO A SFERA 1" BALL VALVE 1"	1
S301	REGOLATORE DI PRESSIONE 1/4" PRESSURE REGULATOR 1/4"	1
S402	VALVOLA DI SICUREZZA 1 bar SAFETY VALVE 1 bar	1

Art. KR4250

KIT GUARNIZIONI COMPLETO
COMPOSTO DALLE GUARNIZIONI SOTTO ELENCATE
JOINTS GASKETS LIST
INCLUDING ALL THE GASKETS SHOWN HERE UNDER

CODICE CODE	DESCRIZIONE DESCRIPTION	Q. TÀ QTY
H034	O-RING 3156 O-RING 3156	1
H044	O-RING 4137 O-RING 4137	2
H057	O-RING 2062 O-RING 2062	2
H059	O-RING 2037 O-RING 2037	1
H064	O-RING 3043 O-RING 3043	2
H066	O-RING 3118 O-RING 3118	1
H157	O-RING 3137 "VITON" O-RING 3137 "VITON"	1
H177	O-RING 4131 O-RING 4131	2
I094	OGIVA STRINGI TUBO CLAMPING TUBE OGIVE	1



Art. 42090 Mod. RO.90L



VISTA ESPLOSA - EXPLODED VIEW

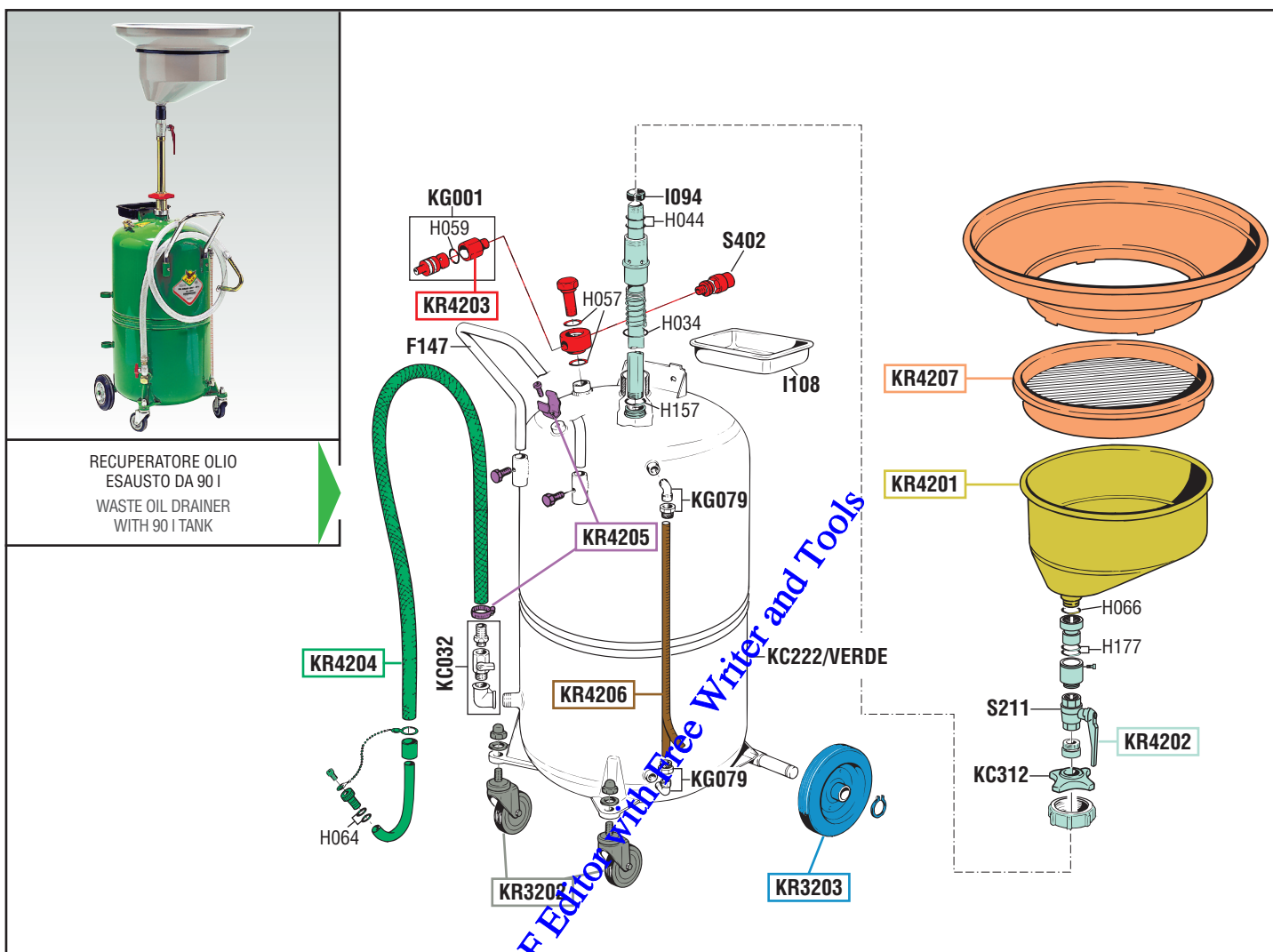

RECUPERATORE OLIO ESAUSTO DA 90 l
WASTE OIL DRAINER WITH 90 l TANK

GUIDA RICAMBI - SPARE PARTS GUIDE

KIT RICAMBI
OGNI KIT SOTTO RIPORTATO COMPRENDE I RICAMBI EVIDENZIATI CON LO STESSO COLORE E LE RELATIVE GUARNIZIONI. QUESTI RICAMBI NON SONO FORNIBILI SEPARATAMENTE TRANNE QUELLI CODIFICATI.

SPARE PARTS KITS
EACH KIT SHOWN WITH THE SAME COLOR INCLUDES ALSO THE GASKETS. THE SPARE PARTS INCLUDED IN THE KIT CAN'T BE SUPPLIED SEPARATELY EXCEPT THOSE SHOWN WITH A PROPER CODE.

CODICE CODE	DESCRIZIONE DESCRIPTION	Q.TÀ QTY
KR3202	DUE RUOTE PIROETTANTI CON DADI TWO SWIVELLING WHEELS WITH NUTS	1
KR3203	2 RUOTE FISSE CON ANELLI ELASTICI 2 FIXED WHEELS WITH RETAINING RINGS	1
KR4201	COPPA RACCOGLI OLIO OIL COLLECTING BOWL	1
KR4202	GRUPPO COLLEGAMENTO CONNECTING GROUP	1
KR4203	GRUPPO RUBINETTO-VALVOLA DI SICUREZZA AIR TAP AND SAFETY VALVE GROUP	1
KR4204	TUBO SCARICO CON FASCETTA STRINGI TUBO DISCHARGING HOSE WITH HOSE CLAMP	1
KR4205	SET DI VITI PER SERBATOIO SET OF SCREWS FOR RESERVOIR	1
KR4206	TUBO LIVELLO CON ETICHETTA GAUGE TUBE WITH LABEL	1
KR4207	IMBUTO CON GRIGLIA FUNNEL WITH NET	1

ELENCO RICAMBI FORNIBILI SINGOLARMENTE
LIST OF SPARE PARTS WHICH CAN BE SUPPLIED SEPARATELY

CODICE CODE	DESCRIZIONE DESCRIPTION	Q.TÀ QTY
F147	MANICO A "U" HANDLE	1
I108	VASCHETTA PORTA OGGETTI TOOL TRAY	1
KC032	GRUPPO SCARICO SERBATOIO DISCHARGING GROUP	1
KC222/VERDE	SERBATOIO 90 l RESERVOIR 90 l	1
KC312	GHIERA IRON RING	1
KG001	RUBINETTO UNIVERSALE CARICA ARIA UNIVERSAL AIR TAP	1
KG079	GRUPPO GOMITO E GHIERA RING AND ELBOW JOINT GROUP	2
S211	RUBINETTO A SFERA 1" BALL VALVE 1"	1
S402	VALVOLA DI SICUREZZA 1 bar SAFETY VALVE 1 bar	1

Art. KR4250
KIT GUARNIZIONI COMPLETO
COMPOSTO DALLE GUARNIZIONI SOTTO ELENCAE
JOINTS GASKETS LIST
INCLUDING ALL THE GASKETS SHOWN HERE UNDER

CODICE CODE	DESCRIZIONE DESCRIPTION	Q.TÀ QTY
H034	O-RING 3156 O-RING 3156	1
H044	O-RING 4137 O-RING 4137	2
H057	O-RING 2062 O-RING 2062	2
H059	O-RING 2037 O-RING 2037	1
H064	O-RING 3043 O-RING 3043	2
H066	O-RING 3118 O-RING 3118	1
H157	O-RING 3137 "VITON" O-RING 3137 "VITON"	1
H177	O-RING 4131 O-RING 4131	2
I094	OGIVA STRINGI TUBO CLAMPING TUBE OGIVE	1

Art. KS4280
SET RICAMBI CONSIGLIATI
AI PUNTI VENDITA E ASSISTENZA,
COMPOSTO DAI RICAMBI SOTTO ELENCAE
SPARE PARTS KIT ADVISED
TO THE REPAIR CENTERS. THIS KIT INCLUDES
ALL THE SPARE PARTS SHOWN HERE UNDER

CODICE CODE	DESCRIZIONE DESCRIPTION	Q.TÀ QTY
KR4204	TUBO SCARICO CON FASCETTA STRINGI TUBO DISCHARGING HOSE WITH HOSE CLAMP	1
KR4250	KIT GUARNIZIONI COMPLETO COMPLETE GASKETS KIT	1

tutti i diritti riservati - all rights reserved



Art. 42091 Mod. RO.C.90L



VISTA ESPLOSA - EXPLODED VIEW

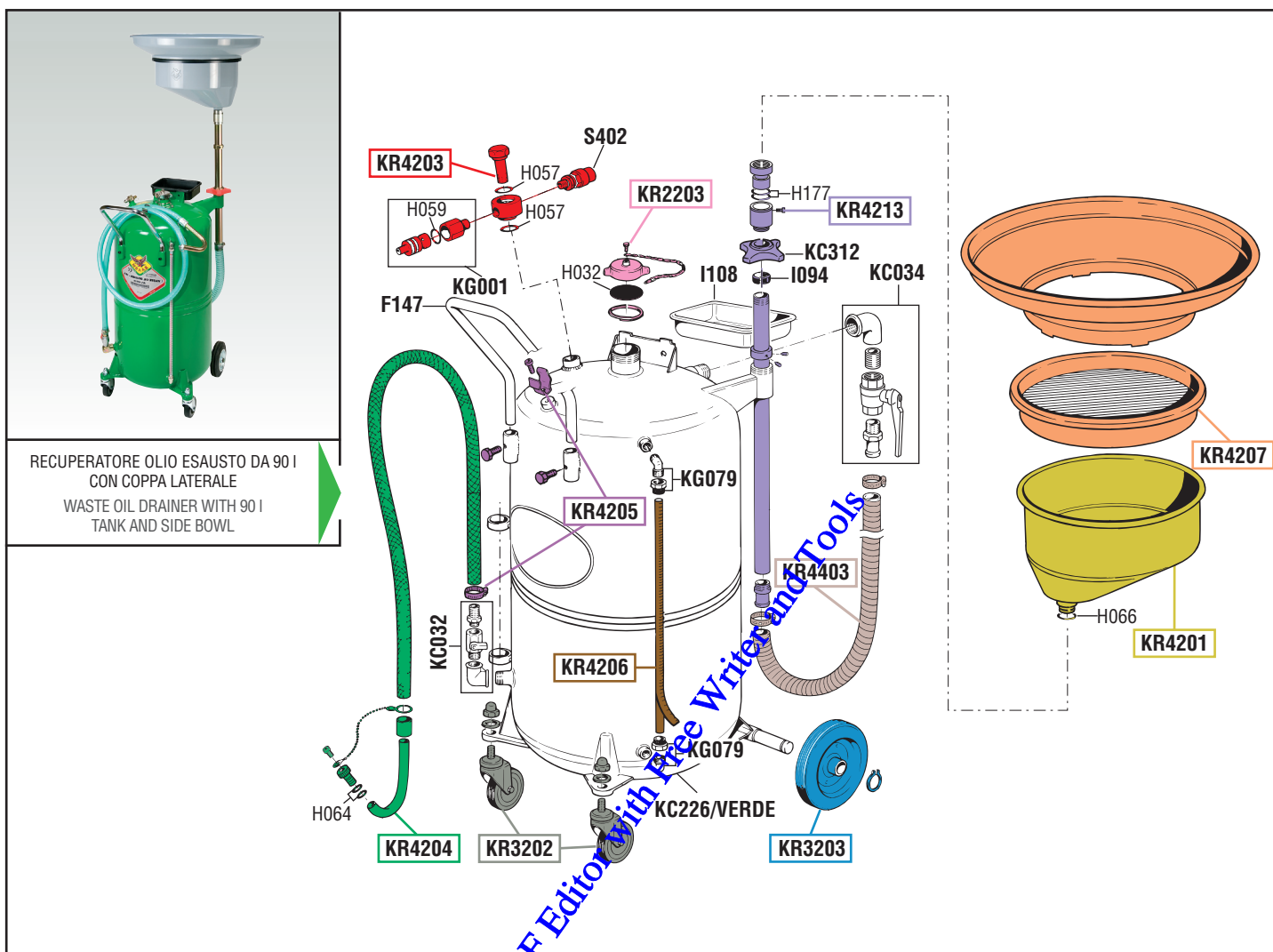

RECUPERATORE OLIO ESAUSTO DA 90 l
CON COPPA LATERALE
WASTE OIL DRAINER WITH 90 l
TANK AND SIDE BOWL

GUIDA RICAMBI - SPARE PARTS GUIDE

KIT RICAMBI
OGNI KIT SOTTO RIPORTATO COMPRENDE I RICAMBI EVIDENZIATI CON LO STESSO COLORE E LE RELATIVE GUARNIZIONI. QUESTI RICAMBI NON SONO FORNIBILI SEPARATAMENTE TRANNE QUELLI CODIFICATI.
SPARE PARTS KITS
EACH KIT SHOWN WITH THE SAME COLOR INCLUDES ALSO THE GASKETS. THE SPARE PARTS INCLUDED IN THE KIT CAN'T BE SUPPLIED SEPARATELY EXCEPT THOSE SHOWN WITH A PROPER CODE.

CODICE CODE	DESCRIZIONE DESCRIPTION	Q.TÀ QTY
KR2203	TAPPO ALTA PRESSIONE HIGH PRESSURE PLUG	1
KR3202	DUE RUOTE PIROETTANTI CON DADI TWO SWIVELLING WHEELS WITH NUTS	1
KR3203	2 RUOTE FISSI CON ANELLI ELASTICI 2 FIXED WHEELS WITH RETAININGS RINGS	1
KR4201	COPPA RACCOGLI OLIO OIL COLLECTING BOWL	1
KR4203	GRUPPO RUBINETTO-VALVOLA DI SICUREZZA AIR TAP AND SAFETY VALVE GROUP	1
KR4204	TUBO SCARICO CON FASCETTA STRINGI TUBO DISCHARGING HOSE WITH HOSE CLAMP	1
KR4205	SET DI VITI PER SERBATOIO SET OF SCREWS FOR RESERVOIR	1
KR4206	TUBO LIVELLO CON ETICHETTA GAUGE TUBE WITH LABEL	1
KR4207	IMBUTO CON GRIGLIA FUNNEL WITH NET	1
KR4213	TUBO SUPPORTO COPPA BOWL SUPPORTING TUBE	1
KR4403	TUBO FLESSIBILE PER SERBATOIO 90 l CONNECTION HOSE FOR 90 l RESERVOIR	1

ELENCO RICAMBI FORNIBILI SINGOLARMENTE
LIST OF SPARE PARTS WHICH CAN BE SUPPLIED SEPARATELY

CODICE CODE	DESCRIZIONE DESCRIPTION	Q.TÀ QTY
F147	MANICO A "U" HANDLE	1
I108	VASCHETTA PORTA OGGETTI TOOL TRAY	1
KC032	GRUPPO SCARICO SERBATOIO DISCHARGING GROUP	1
KC034	GRUPPO SCARICO DISCHARGING GROUP	1
KC226/VERDE	SERBATOIO 90 l RESERVOIR 90 l	1
KC312	GHIERA IRON RING	1
KG001	RUBINETTO UNIVERSALE CARICA ARIA UNIVERSAL AIR TAP	1
KG079	GRUPPO GOMITO E GHIERA RING AND ELBOW JOINT GROUP	2
S402	VALVOLA DI SICUREZZA 1 bar SAFETY VALVE 1 bar	1

Art. KR4252
KIT GUARNIZIONI COMPLETO
COMPOSTO DALLE GUARNIZIONI SOTTO ELENCAE
JOINTS GASKETS LIST
INCLUDING ALL THE GASKETS SHOWN HERE UNDER

CODICE CODE	DESCRIZIONE DESCRIPTION	Q.TÀ QTY
H032	GUARNIZIONE TAPPO GASKET	1
H057	O-RING 2062 O-RING 2062	2
H059	O-RING 2037 O-RING 2037	1
H064	O-RING 3043 O-RING 3043	2
H066	O-RING 3118 O-RING 3118	1
H177	O-RING 4131 O-RING 4131	2
I094	OGIVA STRINGI TUBO CLAMPING TUBE OGVIE	1

Art. KS4282
SET RICAMBI CONSIGLIATI
AI PUNTI VENDITA E ASSISTENZA,
COMPOSTO DAI RICAMBI SOTTO ELENCAE
SPARE PARTS KIT ADVISED
TO THE REPAIR CENTERS. THIS KIT INCLUDES
ALL THE SPARE PARTS SHOWN HERE UNDER

CODICE CODE	DESCRIZIONE DESCRIPTION	Q.TÀ QTY
KR4204	TUBO SCARICO CON FASCETTA STRINGI TUBO DISCHARGING HOSE WITH HOSE CLAMP	1
KR4403	TUBO FLESSIBILE PER SERBATOIO 90 l CONNECTION HOSE FOR 90 l RESERVOIR	1
KR4252	KIT GUARNIZIONI COMPLETO COMPLETE GASKETS KIT	1

tutti i diritti riservati - all rights reserved



Art. 42092 Mod. RO.90L



VISTA ESPLOSA - EXPLODED VIEW

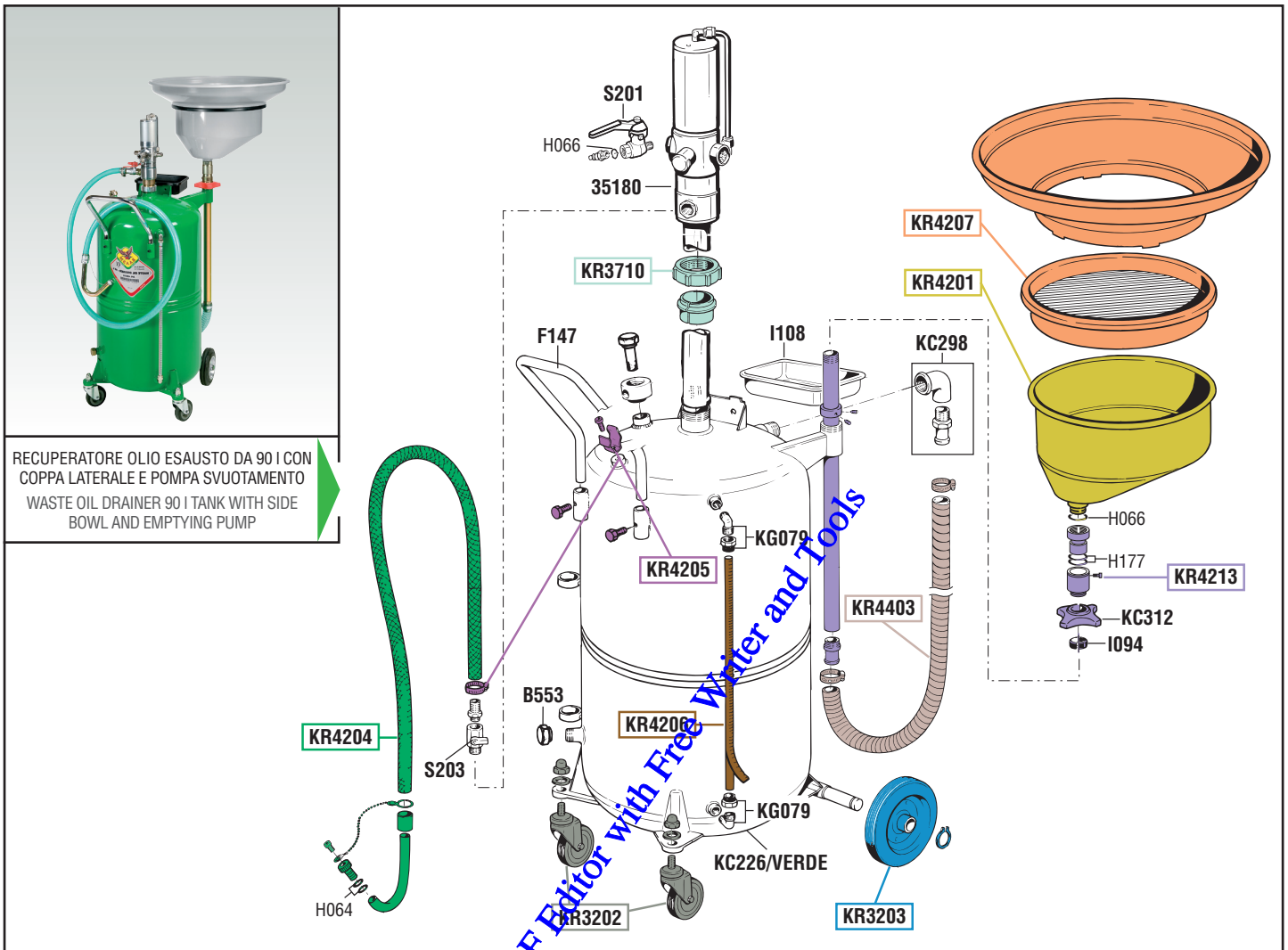

RECUPERATORE OLIO ESAUSTO DA 90 L CON COPPA LATERALE E POMPA SVUOTAMENTO
WASTE OIL DRAINER 90 L TANK WITH SIDE BOWL AND EMPTYING PUMP

GUIDA RICAMBI - SPARE PARTS GUIDE

KIT RICAMBI
OGNI KIT SOTTO RIPORTATO COMPRENDE I RICAMBI EVIDENZIATI CON LO STESSO COLORE E LE RELATIVE GUARNIZIONI. QUESTI RICAMBI NON SONO FORNIBILI SEPARATAMENTE TRANNE QUELLI CODIFICATI.

SPARE PARTS KITS
EACH KIT SHOWN WITH THE SAME COLOR INCLUDES ALSO THE GASKETS. THE SPARE PARTS INCLUDED IN THE KIT CAN'T BE SUPPLIED SEPARATELY EXCEPT THOSE SHOWN WITH A PROPER CODE.

CODICE CODE	DESCRIZIONE DESCRIPTION	Q.TÀ QTY
KR3202	DUE RUOTE PIROETTANTI CON DADI TWO SWIVELLING WHEELS WITH NUTS	1
KR3203	2 RUOTE FISSE CON ANELLI ELASTICI 2 FIXED WHEELS WITH RETAINING RINGS	1
KR3710	GHIERA IRON RING	1
KR4201	COPPA RACCOGLI OLIO OIL COLLECTING BOWL	1
KR4204	TUBO SCARICO CON FASCETTA STRINGI TUBO DISCHARGING HOSE WITH HOSE CLAMP	1
KR4205	SET DI VITI PER SERBATOIO SET OF SCREWS FOR RESERVOIR	1
KR4206	TUBO LIVELLO CON ETICHETTA GAUGE TUBE WITH LABEL	1
KR4207	IMBUTO CON GRIGLIA FUNNEL WITH NET	1
KR4213	TUBO SUPPORTO COPPA BOWL SUPPORTING TUBE	1
KR4403	TUBO FLESSIBILE PER SERBATOIO 90 L CONNECTION HOSE FOR 90 L RESERVOIR	1

ELENCO RICAMBI FORNIBILI SINGOLARMENTE
LIST OF SPARE PARTS WHICH CAN BE SUPPLIED SEPARATELY

CODICE CODE	DESCRIZIONE DESCRIPTION	Q.TÀ QTY
F147	MANICO A "U" HANDLE	1
I108	VASCHETTA PORTA OGGETTI TOOL TRAY	1
B553	TAPPO DI SCARICO PLUG	1
KC298	GRUPPO SCARICO COPPA DISCHARGING GROUP	1
KC226/VERDE	SERBATOIO 90 L RESERVOIR 90 L	1
KC312	GHIERA IRON RING	1
KG079	GRUPPO GOMITO E GHIERA RING AND ELBOW JOINT GROUP	2
S201	RUBINETTO A SFERA 1/4" BALL VALVE 1/4"	1
S203	RUBINETTO A SFERA 1/2" BALL VALVE 1/2"	1

Art. KR4254
KIT GUARNIZIONI COMPLETO
COMPOSTO DALLE GUARNIZIONI SOTTO ELENCAE
JOINTS GASKETS LIST
INCLUDING ALL THE GASKETS SHOWN HERE UNDER

CODICE CODE	DESCRIZIONE DESCRIPTION	Q.TÀ QTY
H059	O-RING 2037 O-RING 2037	1
H064	O-RING 3043 O-RING 3043	2
H066	O-RING 3118 O-RING 3118	1
H177	O-RING 4131 O-RING 4131	2
I094	OGIVA STRINGI TUBO CLAMPING TUBE OGVIE	1

Art. KS4284
SET RICAMBI CONSIGLIATI
AI PUNTI VENDITA E ASSISTENZA,
COMPOSTO DAI RICAMBI SOTTO ELENCAE
SPARE PARTS KIT ADVISED
TO THE REPAIR CENTERS. THIS KIT INCLUDES
ALL THE SPARE PARTS SHOWN HERE UNDER

CODICE CODE	DESCRIZIONE DESCRIPTION	Q.TÀ QTY
KR4204	TUBO SCARICO CON FASCETTA STRINGI TUBO DISCHARGING HOSE WITH HOSE CLAMP	1
KR4403	TUBO FLESSIBILE PER SERBATOIO 90 L CONNECTION HOSE FOR 90 L RESERVOIR	1
KR4254	KIT GUARNIZIONI COMPLETO COMPLETE GASKETS KIT	1

PER I KIT RICAMBI DELL' Art. 35180 VEDERE I RELATIVI ESPLOSI
FOR THE SPARE PARTS KITS OF Art. 35180 PLEASE REFER TO PERTINENT EXPLODED VIEWS

tutti i diritti riservati - all rights reserved



Art. 42101 Mod. RO.S.100L - Art. 42102 Mod. RO.S.100L



VISTA ESPLOSA - EXPLODED VIEW

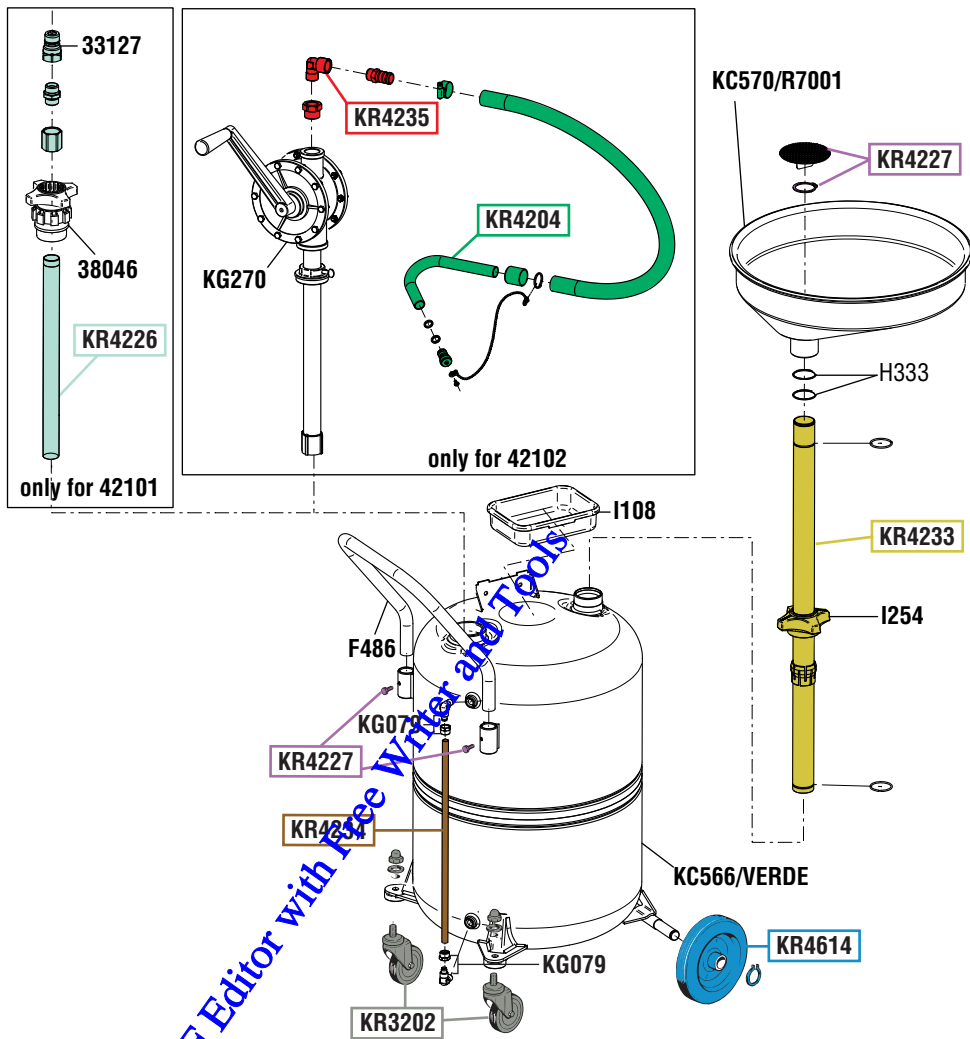

tutti i diritti riservati - all rights reserved

GUIDA RICAMBI - SPARE PARTS GUIDE

KIT RICAMBI
OGNI KIT SOTTO RIPORTATO COMPRENDE I RICAMBI EVIDENZIATI CON LO STESSO COLORE E LE RELATIVE GUARNIZIONI. QUESTI RICAMBI NON SONO FORNIBILI SEPARATAMENTE TRAMIE QUELLI CODIFICATI.

SPARE PARTS KITS
EACH KIT SHOWN WITH THE SAME COLOR INCLUDES ALSO THE GASKETS. THE SPARE PARTS INCLUDED IN THE KIT CAN'T BE SUPPLIED SEPARATELY EXCEPT THOSE SHOWN WITH A PROPER CODE.

CODICE CODE	DESCRIZIONE DESCRIPTION	Q.TÀ QTY
KR3202	DUE RUOTE PIROETTANTI CON DADI TWO SWIVELLING WHEELS WITH NUTS	1
KR4204	TUBO SCARICO CON FASCETTA STRINGI TUBO DISCHARGING HOSE WITH HOSE CLAMP	1
KR4226	TUBO ASPIRAZIONE E ATTACCO RAPIDO SUCTION TUBE AND QUICK CONNECTOR	1
KR4227	GRUPPO FILTRO E VITI SET OF SCREWS FOR RESERVOIR	1
KR4233	TUBO SUPPORTO COPPA BOWL SUPPORT HOSE	1
KR4234	TUBO LIVELLO CON ETICHETTA GAUGE TUBE WITH LABEL	1
KR4235	ACCESSORI ACCESSORIES	1
KR4614	2 RUOTE Fisse CON ANELLI ELASTICI 2 FIXED WHEELS WITH RETAINING RINGS	1

ELENCO RICAMBI FORNIBILI SINGOLARMENTE
LIST OF SPARE PARTS WHICH CAN BE SUPPLIED SEPARATELY

CODICE CODE	DESCRIZIONE DESCRIPTION	Q.TÀ QTY
33127	ATTACCO RAPIDO MASCHIO MALE QUICK CONNECTION	1
38046	GHIERA DI BLOCCAGGIO ø 32 mm BUNG ADAPTOR ø 32 mm	1
F486	MANICO A "U" HANDLE	1
H333	O-RING 3168 "VITON" O-RING 3168 "VITON"	2
I108	VASCHETTA PORTA OGGETTI TOOL TRAY	1
I254	GHIERA IRON RING	1
KC566/VERDE	SERBATOIO 100 l RESERVOIR 100 l	1
KC570/R7001	COPPA RACCOGLI OLIO OIL COLLECTING BOWL	1
KG079	GRUPPO GOMITO E GHIERA RING AND ELBOW JOINT GROUP	2
KG270	POMPA ROTATIVA MANUALE ROTATORY MANUAL PUMP	1



Art. 42103 Mod. RO.P.100L



VISTA ESPLOSA - EXPLODED VIEW

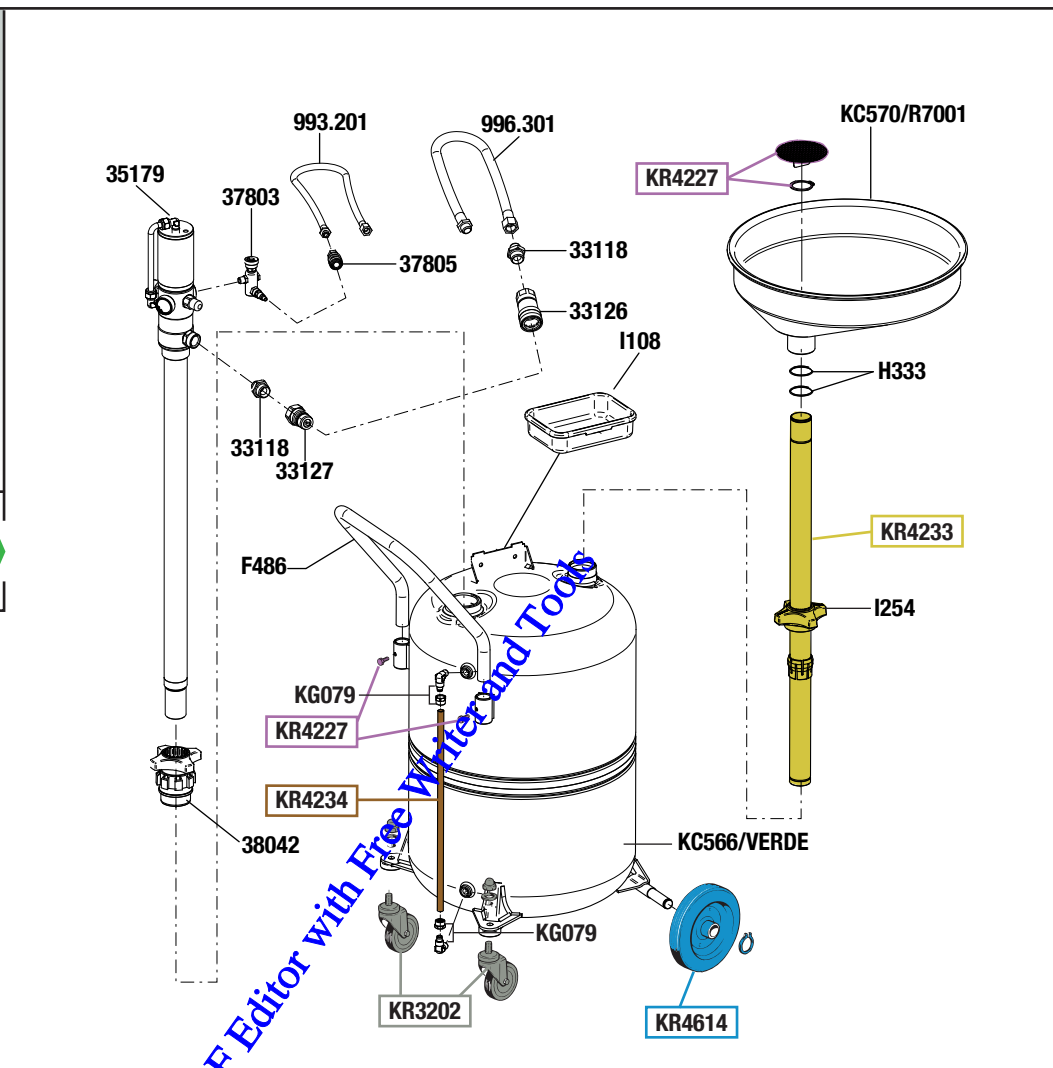

GUIDA RICAMBI - SPARE PARTS GUIDE

KIT RICAMBI

OGNI KIT SOTTO RIPORTATO COMPRENDE I RICAMBI EVIDENZIATI CON LO STESSO COLORE E LE RELATIVE GUARNIZIONI. QUESTI RICAMBI NON SONO FORNIBILI SEPARATAMENTE TRanne QUELLI CODIFICATI.

SPARE PARTS KITS

EACH KIT SHOWN WITH THE SAME COLOR INCLUDES ALSO THE GASKETS. THE SPARE PARTS INCLUDED IN THE KIT CAN'T BE SUPPLIED SEPARATELY EXCEPT THOSE SHOWN WITH A PROPER CODE.

CODICE CODE	DESCRIZIONE DESCRIPTION	Q.TÀ QTY
KR3202	DUE RUOTE PIROETTANTI CON DADI TWO SWIVELLING WHEELS WITH NUTS	1
KR4227	GRUPPO FILTRO E VITI SET OF SCREWS FOR RESERVOIR	1
KR4233	TUBO SUPPORTO COPPA BOWL SUPPORT HOSE	1
KR4234	TUBO LIVELLO CON ETICHETTA GAUGE TUBE WITH LABEL	1
KR4614	2 RUOTE FISSE CON ANELLI ELASTICI 2 FIXED WHEELS WITH RETAINING RINGS	1

ELENCO RICAMBI FORNIBILI SINGOLARMENTE

LIST OF SPARE PARTS WHICH CAN BE SUPPLIED SEPARATELY

CODICE CODE	DESCRIZIONE DESCRIPTION	Q.TÀ QTY
33118	NIPPLE M 1/2" G x M 3/4" G NIPPLE M 1/2" G x M 3/4" G	2
33126	ATTACCO RAPIDO FEMMINA FEMALE QUICK CONNECTION	1
33127	ATTACCO RAPIDO MASCHIO MALE QUICK CONNECTION	1
35179	POMPA PER SVUOTAMENTO R 3:1 SUCTION PUMP R 3:1	2
37803	KIT REGOLAZIONE FLUSSO ARIA AIR FLOW REGULATOR KIT	1
37805	RUBINETTO ATTACCO RAPIDO F 1/4" G QUICK TAP F 1/4" G	1
38042	GHIERA DI BLOCCAGGIO ø 42 mm BUNG ADAPTOR ø 42 mm	1
993.201	TUBO 1/4" - 1 m - 20 bar HOSE 1/4" - 1 m - 20 bar	1
996.301	TUBO 1/2" M/F 150 bar HOSE 1/2" M/F 150 bar	1
F486	MANICO A "U" HANDLE	1
H333	O-RING 3168 "VITON" O-RING 3168 "VITON"	2
I108	VASCHETTA PORTA OGGETTI TOOL TRAY	1
I254	GHIERA IRON RING	1
KC566/VERDE	SERBATOIO 100 l RESERVOIR 100 l	1
KC570/R7001	COPPA RACCOGLI OLIO OIL COLLECTING BOWL	1
KG079	GRUPPO GOMITO E GHIERA RING AND ELBOW JOINT GROUP	2

PER I KIT RICAMBI DELL' Art. 35179 VEDERE I RELATIVI ESPLOSI
FOR THE SPARE PARTS KITS OF Art. 35179 PLEASE REFER TO PERTINENT EXPLODED VIEWS



Art. 42115 Mod. R0.115L

VISTA ESPLOSA - EXPLODED VIEW

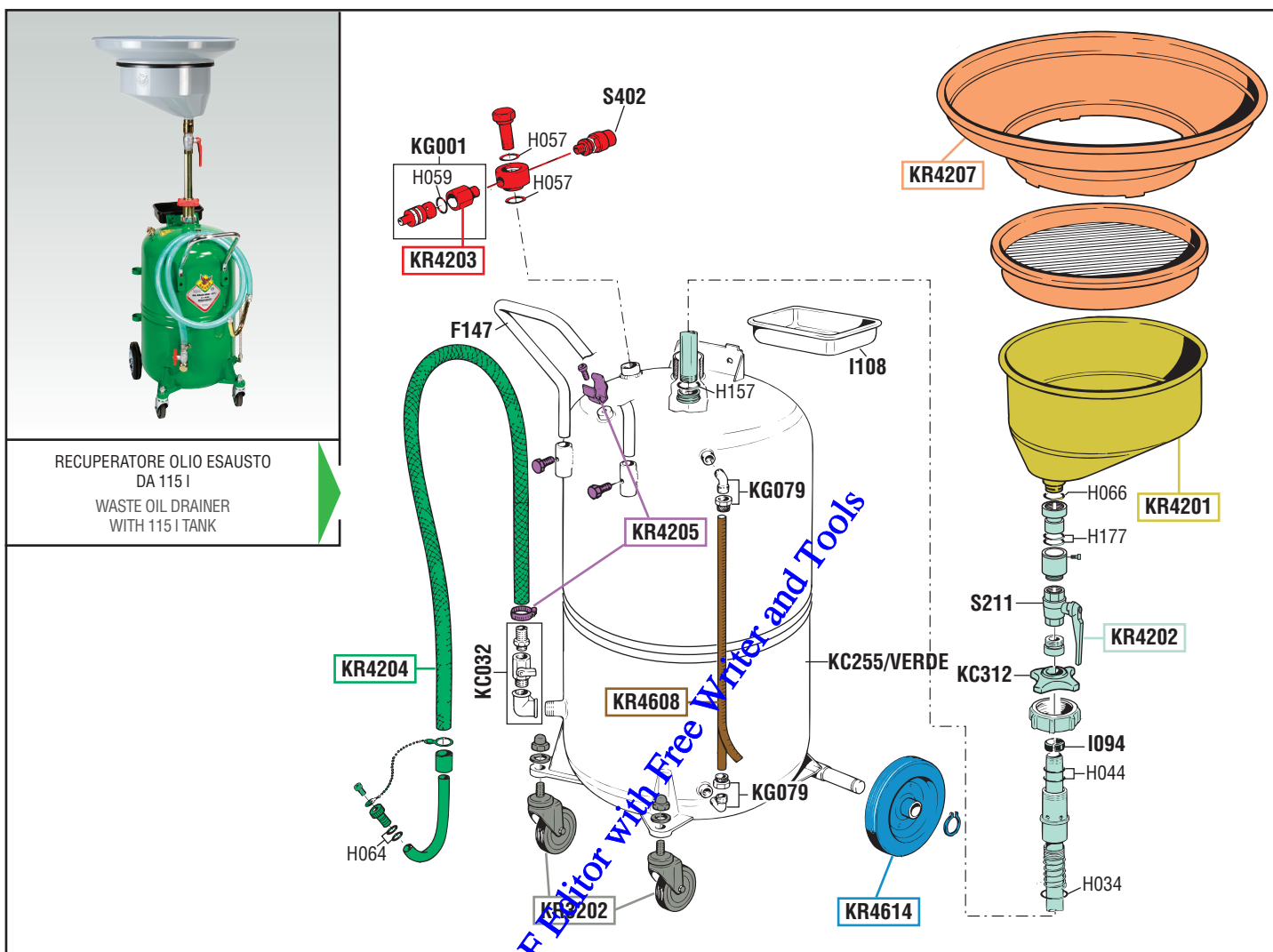

RECUPERATORE OLIO ESAUSTO DA 115 l
WASTE OIL DRAINER WITH 115 l TANK

GUIDA RICAMBI - SPARE PARTS GUIDE

KIT RICAMBI
OGNI KIT SOTTO RIPORTATO COMPRENDE I RICAMBI EVIDENZIATI CON LO STESSO COLORE E LE RELATIVE GUARNIZIONI. QUESTI RICAMBI NON SONO FORNIBILI SEPARATAMENTE TRANNE QUELLI CODIFICATI.

SPARE PARTS KITS
EACH KIT SHOWN WITH THE SAME COLOR INCLUDES ALSO THE GASKETS. THE SPARE PARTS INCLUDED IN THE KIT CAN'T BE SUPPLIED SEPARATELY EXCEPT THOSE SHOWN WITH A PROPER CODE.

CODICE CODE	DESCRIZIONE DESCRIPTION	Q.TÀ QTY
KR3202	DUE RUOTE PIROETTANTI CON DADI TWO SWIVELLING WHEELS WITH NUTS	1
KR4201	COPPA RACCOGLI OLIO OIL COLLECTING BOWL	1
KR4202	GRUPPO COLLEGAMENTO CONNECTING GROUP	1
KR4203	GRUPPO RUBINETTO-VALVOLA DI SICUREZZA AIR TAP AND SAFETY VALVE GROUP	1
KR4204	TUBO SCARICO CON FASCETTA STRINGI TUBO DISCHARGING HOSE WITH HOSE CLAMP	1
KR4205	SET DI VITI PER SERBATOIO SET OF SCREWS FOR RESERVOIR	1
KR4207	IMBUTO CON GRIGLIA FUNNEL WITH NET	1
KR4608	TUBO LIVELLO CON ETICHETTA GAUGE TUBE WITH LABEL	1
KR4614	2 RUOTE Fisse CON ANELLI ELASTICI 2 FIXED WHEELS WITH RETAINING RINGS	1

ELENCO RICAMBI FORNIBILI SINGOLARMENTE
LIST OF SPARE PARTS WHICH CAN BE SUPPLIED SEPARATELY

CODICE CODE	DESCRIZIONE DESCRIPTION	Q.TÀ QTY
F147	MANICO A "U" HANDLE	1
I108	VASCHETTA PORTA OGGETTI TOOL TRAY	1
KC032	GRUPPO SCARICO SERBATOIO DISCHARGING GROUP	1
KC255/VERDE	SERBATOIO 115 l RESERVOIR 115 l	1
KC312	GHIERA IRON RING	1
KG001	RUBINETTO UNIVERSALE CARICA ARIA UNIVERSAL AIR TAP	1
KG079	GRUPPO GOMITO E GHIERA RING AND ELBOW JOINT GROUP	2
S211	RUBINETTO A SFERA 1" BALL VALVE 1"	1
S402	VALVOLA DI SICUREZZA 1 bar SAFETY VALVE 1 bar	1

Art. KR4250
KIT GUARNIZIONI COMPLETO
COMPOSTO DALLE GUARNIZIONI SOTTO ELENCAE
JOINTS GASKETS LIST
INCLUDING ALL THE GASKETS SHOWN HERE UNDER

CODICE CODE	DESCRIZIONE DESCRIPTION	Q.TÀ QTY
H034	O-RING 3156 O-RING 3156	1
H044	O-RING 4137 O-RING 4137	2
H057	O-RING 2062 O-RING 2062	2
H059	O-RING 2037 O-RING 2037	1
H064	O-RING 3043 O-RING 3043	2
H066	O-RING 3118 O-RING 3118	1
H157	O-RING 3137 "VITON" O-RING 3137 "VITON"	1
H177	O-RING 4131 O-RING 4131	2
I094	OGIVA STRINGI TUBO CLAMPING TUBE OGIVE	1

Art. KS4280
SET RICAMBI CONSIGLIATI
AI PUNTI VENDITA E ASSISTENZA,
COMPOSTO DAI RICAMBI SOTTO ELENCAE
SPARE PARTS KIT ADVISED
TO THE REPAIR CENTERS. THIS KIT INCLUDES
ALL THE SPARE PARTS SHOWN HERE UNDER

CODICE CODE	DESCRIZIONE DESCRIPTION	Q.TÀ QTY
KR4204	TUBO SCARICO CON FASCETTA STRINGI TUBO DISCHARGING HOSE WITH HOSE CLAMP	1
KR4250	KIT GUARNIZIONI COMPLETO COMPLETE GASKETS KIT	1

tutti i diritti riservati - all rights reserved



Art. 42116 Mod. RO.C.115L



VISTA ESPLOSA - EXPLODED VIEW

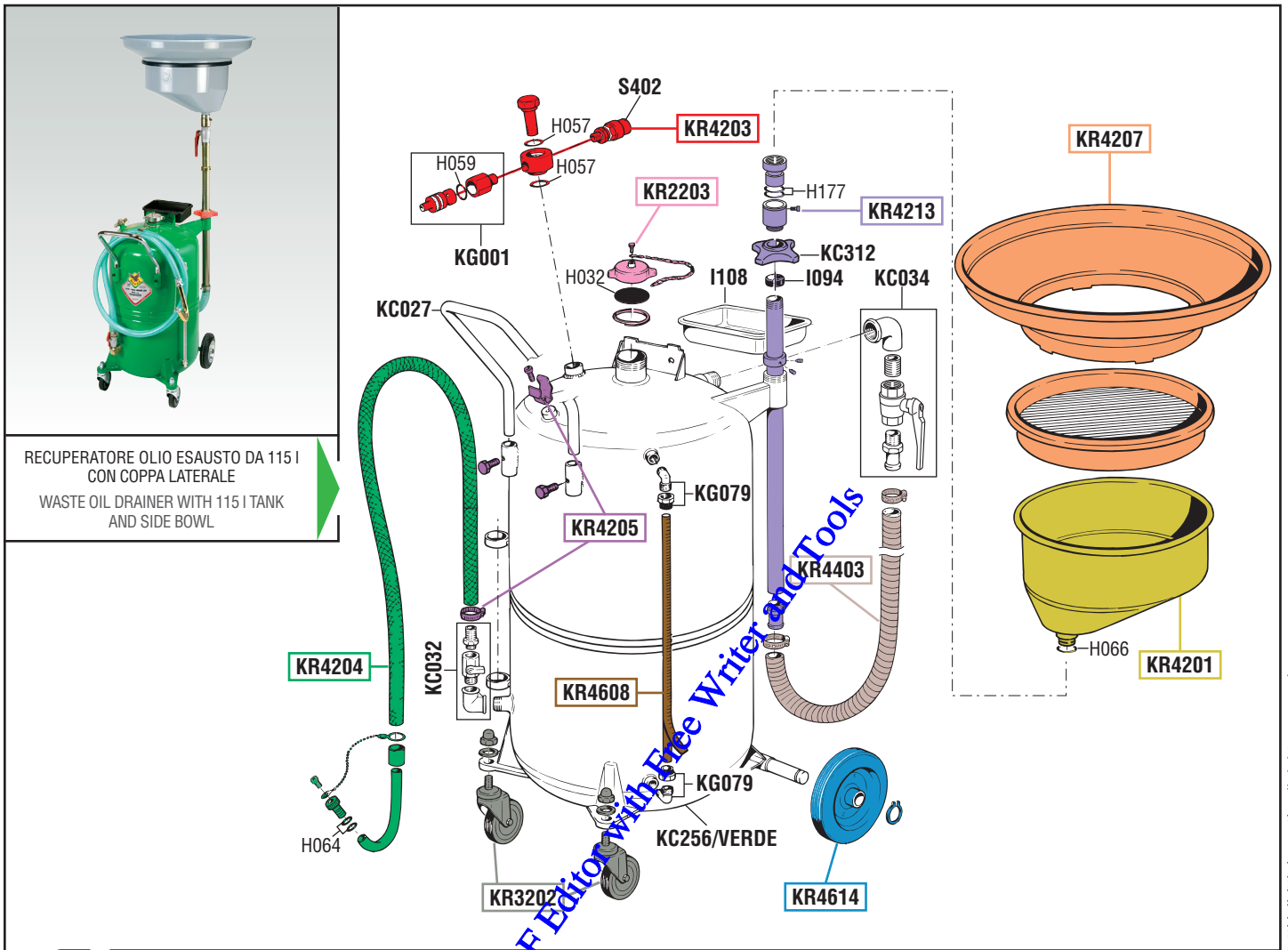

RECUPERATORE OLIO ESAUSTO DA 115 l
CON COPPA LATERALE
WASTE OIL DRAINER WITH 115 l TANK
AND SIDE BOWL

tutti i diritti riservati - all rights reserved

GUIDA RICAMBI - SPARE PARTS GUIDE

KIT RICAMBI
OGNI KIT SOTTO RIPORTATO COMPRENDE I RICAMBI EVIDENZIATI CON LO STESSO COLORE E LE RELATIVE GUARNIZIONI. QUESTI RICAMBI NON SONO FORNIBILI SEPARATAMENTE TRANNE QUELLI CODIFICATI.

SPARE PARTS KITS
EACH KIT SHOWN WITH THE SAME COLOR INCLUDES ALSO THE GASKETS. THE SPARE PARTS INCLUDED IN THE KIT CAN'T BE SUPPLIED SEPARATELY EXCEPT THOSE SHOWN WITH A PROPER CODE.

CODICE CODE	DESCRIZIONE DESCRIPTION	Q.TÀ QTY
KR2203	TAPPO ALTA PRESSIONE HIGH PRESSURE PLUG	1
KR3202	DUE RUOTE PIROETTANTI CON DADI TWO SWIVELLING WHEELS WITH NUTS	1
KR4201	COPPA RACCOGLI OLIO OIL COLLECTING BOWL	1
KR4203	GRUPPO RUBINETTO-VALVOLA DI SICUREZZA AIR TAP AND SAFETY VALVE GROUP	1
KR4204	TUBO SCARICO CON FASCETTA STRINGI TUBO DISCHARGING HOSE WITH HOSE CLAMP	1
KR4205	SET DI VITI PER SERBATOIO SET OF SCREWS FOR RESERVOIR	1
KR4207	IMBUTO CON GRIGLIA FUNNEL WITH NET	1
KR4213	TUBO SUPPORTO COPPA BOWL SUPPORTING TUBE	1
KR4403	TUBO FLESSIBILE PER SERBATOIO 115 l CONNECTION HOSE FOR 115 l RESERVOIR	1
KR4608	TUBO LIVELLO CON ETICHETTA GAUGE TUBE WITH LABEL	1
KR4614	2 RUOTE Fisse con anelli elastici 2 FIXED WHEELS WITH RETAINING RINGS	1

ELENCO RICAMBI FORNIBILI SINGOLARMENTE
LIST OF SPARE PARTS WHICH CAN BE SUPPLIED SEPARATELY

CODICE CODE	DESCRIZIONE DESCRIPTION	Q.TÀ QTY
KC027	MANICO A "U" HANDLE	1
I108	VASCHETTA PORTA OGGETTI TOOL TRAY	1
KC032	GRUPPO SCARICO SERBATOIO DISCHARGING GROUP	1
KC034	GRUPPO SCARICO DISCHARGING GROUP	1
KC256/VERDE	SERBATOIO 115 l RESERVOIR 115 l	1
KC312	GHERA IRON RING	1
KG001	RUBINETTO UNIVERSALE CARICA ARIA UNIVERSAL AIR TAP	1
KG079	GRUPPO GOMITO E GHERA RING AND ELBOW JOINT GROUP	2
S402	VALVOLA DI SICUREZZA 1 bar SAFETY VALVE 1 bar	1

Art. KR4252
KIT GUARNIZIONI COMPLETO
COMPOSTO DALLE GUARNIZIONI SOTTO ELENCAE
JOINTS GASKETS LIST
INCLUDING ALL THE GASKETS SHOWN HERE UNDER

CODICE CODE	DESCRIZIONE DESCRIPTION	Q.TÀ QTY
H032	GUARNIZIONE TAPPO GASKET	1
H057	O-RING 2062 O-RING 2062	2
H059	O-RING 2037 O-RING 2037	1
H064	O-RING 3043 O-RING 3043	2
H066	O-RING 3118 O-RING 3118	1
H177	O-RING 4131 O-RING 4131	2
I094	OGIVA STRINGI TUBO CLAMPING TUBE OGIVE	1

Art. KS4282
SET RICAMBI CONSIGLIATI
AI PUNTI VENDITA E ASSISTENZA,
COMPOSTO DAI RICAMBI SOTTO ELENCAE
SPARE PARTS KIT ADVISED
TO THE REPAIR CENTERS. THIS KIT INCLUDES
ALL THE SPARE PARTS SHOWN HERE UNDER

CODICE CODE	DESCRIZIONE DESCRIPTION	Q.TÀ QTY
KR4204	TUBO SCARICO CON FASCETTA STRINGI TUBO DISCHARGING HOSE WITH HOSE CLAMP	1
KR4403	TUBO FLESSIBILE PER SERBATOIO 115 l CONNECTION HOSE FOR 115 l RESERVOIR	1
KR4252	KIT GUARNIZIONI COMPLETO COMPLETE GASKETS KIT	1



Art. 42160 Mod. RO.65L



VISTA ESPLOSA - EXPLODED VIEW

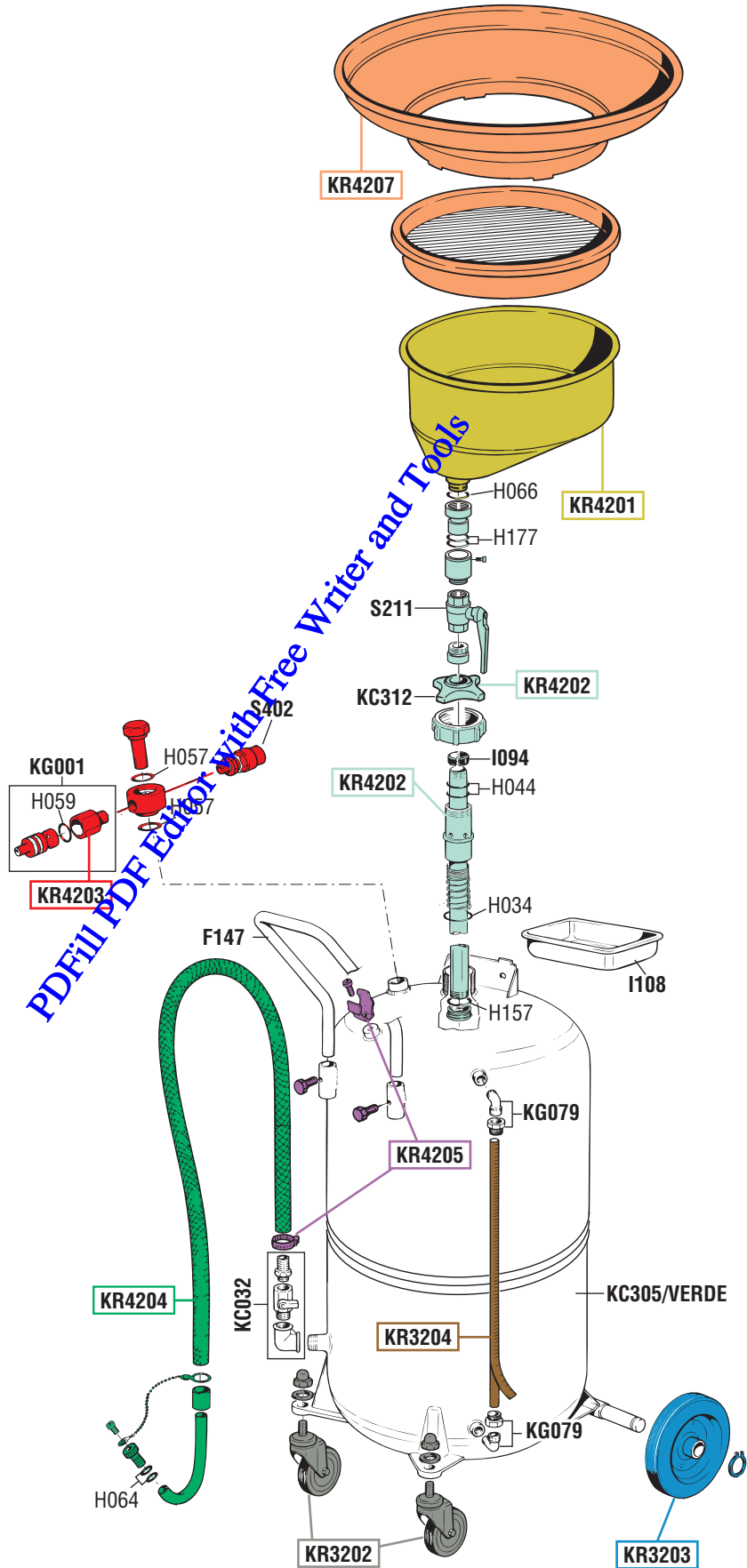

PDFFill PDF Editor with Free Writer and Tools

tutti i diritti riservati - all rights reserved



GUIDA RICAMBI - SPARE PARTS GUIDE

KIT RICAMBI OGNI KIT SOTTO RIPORTATO COMPRENDE I RICAMBI EVIDENZIATI CON LO STESSO COLORE E LE RELATIVE GUARNIZIONI. QUESTI RICAMBI NON SONO FORNIBILI SEPARATAMENTE TRANNE QUELLI CODIFICATI.		
SPARE PARTS KITS EACH KIT SHOWN WITH THE SAME COLOR INCLUDES ALSO THE GASKETS. THE SPARE PARTS INCLUDED IN THE KIT CAN'T BE SUPPLIED SEPARATELY EXCEPT THOSE SHOWN WITH A PROPER CODE.		
CODICE CODE	DESCRIZIONE DESCRIPTION	Q.TÀ QTY
KR3202	DUE RUOTE PIROETTANTI CON DADI TWO SWIVELLING WHEELS WITH NUTS	1
KR3203	2 RUOTE FISSE CON ANELLI ELASTICI 2 FIXED WHEELS WITH RETAINING RINGS	1
KR3204	TUBO DI LIVELLO ED ETICHETTA GAUGE TUBE AND LABEL	1
KR4201	COPPA RACCOGLI OLIO OIL COLLECTING BOWL	1
KR4202	GRUPPO COLLEGAMENTO CONNECTING GROUP	1
KR4203	GRUPPO RUBINETTO-VALVOLA DI SICUREZZA AIR TAP AND SAFETY VALVE GROUP	1
KR4204	TUBO SCARICO CON FASCETTA STRINGI TUBO DISCHARGING HOSE WITH HOSE CLAMP	1
KR4205	SET DI VITI PER SERBATOIO SET OF SCREWS FOR RESERVOIR	1
KR4207	IMBUTO CON GRIGLIA FUNNEL WITH NET	1

ELENCO RICAMBI FORNIBILI SINGOLARMENTE LIST OF SPARE PARTS WHICH CAN BE SUPPLIED SEPARATELY		
CODICE CODE	DESCRIZIONE DESCRIPTION	Q.TÀ QTY
F147	MANICO A "U" HANDLE	1
I108	VASCHETTA PORTA OGGETTI TOOL TRAY	1
KC032	GRUPPO SCARICO SERBATOIO DISCHARGING GROUP	1
KC305/VERDE	SERBATOIO 65 l RESERVOIR 65 l	1
KC312	GHIERA IRON RING	1
KG001	RUBINETTO UNIVERSALE CARICA ARIA UNIVERSAL AIR TAP	1
KG079	GRUPPO GOMITO E GHIERA RING AND ELBOW JOINT GROUP	2
S211	RUBINETTO A SFERA 1" BALL VALVE 1"	1
S402	VALVOLA DI SICUREZZA 1 bar SAFETY VALVE 1 bar	1

Art. KR4250 KIT GUARNIZIONI COMPLETO COMPOSTO DALLE GUARNIZIONI SOTTO ELENCAE JOINTS GASKETS LIST INCLUDING ALL THE GASKETS SHOWN HERE UNDER		
CODICE CODE	DESCRIZIONE DESCRIPTION	Q.TÀ QTY
H034	O-RING 3156 O-RING 3156	1
H044	O-RING 4137 O-RING 4137	2
H057	O-RING 2062 O-RING 2062	2
H059	O-RING 2037 O-RING 2037	1
H064	O-RING 3043 O-RING 3043	2
H066	O-RING 3118 O-RING 3118	1
H157	O-RING 3137 "VITON" O-RING 3137 "VITON"	1
H177	O-RING 4131 O-RING 4131	2
I094	OGIVA STRINGI TUBO CLAMPING TUBE OGIVE	1

Art. KS4280 SET RICAMBI CONSIGLIATI AI PUNTI VENDITA E ASSISTENZA, COMPOSTO DAI RICAMBI SOTTO ELENCAE SPARE PARTS KIT ADVISED TO THE REPAIR CENTERS. THIS KIT INCLUDES ALL THE SPARE PARTS SHOWN HERE UNDER		
CODICE CODE	DESCRIZIONE DESCRIPTION	Q.TÀ QTY
KR4204	TUBO SCARICO CON FASCETTA STRINGI TUBO DISCHARGING HOSE WITH HOSE CLAMP	1
KR4250	KIT GUARNIZIONI COMPLETO COMPLETE GASKETS KIT	1

PDFfill PDF Editor with Free Writer and Tools

GUIDA RICAMBI - SPARE PARTS GUIDE

KIT RICAMBI OGNI KIT SOTTO RIPORTATO COMPRENDE I RICAMBI EVIDENZIATI CON LO STESSO COLORE E LE RELATIVE GUARNIZIONI. QUESTI RICAMBI NON SONO FORNIBILI SEPARATAMENTE TRANNE QUELLI CODIFICATI.		
SPARE PARTS KITS EACH KIT SHOWN WITH THE SAME COLOR INCLUDES ALSO THE GASKETS. THE SPARE PARTS INCLUDED IN THE KIT CAN'T BE SUPPLIED SEPARATELY EXCEPT THOSE SHOWN WITH A PROPER CODE.		
CODICE CODE	DESCRIZIONE DESCRIPTION	Q.TÀ QTY
KR3202	DUE RUOTE PIROETTANTI CON DADI TWO SWIVELLING WHEELS WITH NUTS	1
KR3203	2 RUOTE FISSI CON ANELLI ELASTICI 2 FIXED WHEELS WITH RETAINING RINGS	1
KR3204	TUBO DI LIVELLO ED ETICHETTA GAUGE TUBE AND LABEL	1
KR4203	GRUPPO RUBINETTO-VALVOLA DI SICUREZZA AIR TAP AND SAFETY VALVE GROUP	1
KR4204	TUBO SCARICO CON FASCETTA STRINGI TUBO DISCHARGING HOSE WITH HOSE CLAMP	1
KR4205	SET DI VITI PER SERBATOIO SET OF SCREWS FOR RESERVOIR	1
KR4302	TUBO ASPIRAZIONE COMPLETO COMPLETE SUCTION HOSE	1
KR4304	GRUPPO ASPIRAZIONE CON RUBINETTO SUCTION GROUP WITH TAP	1
KR4601	DUE RUOTE PIROETTANTI CON DADI TWO SWIVELLING WHEELS WITH NUTS	1
KR4602	KIT DUE BRACCI PER RECUP. A PANTOGRAFO TWO ARMS KIT FOR PANTOGRAPH DRAINER	1
KR4603	SET VITI PER BRACCI PANTOGRAFO SET OF SCREWS FOR PANTOGRAPH ARMS	1
KR4604	TUBO FLESSIBILE PER SERBATIO 65 l CONNECTING HOSE FOR 65 l RESERVOIR	1
KR4605	TAPPO RIDUTTORE ASPIRAZIONE SUCTION REDUCTION PLUG	1

ELENCO RICAMBI FORNIBILI SINGOLARMENTE LIST OF SPARE PARTS WHICH CAN BE SUPPLIED SEPARATELY		
CODICE CODE	DESCRIZIONE DESCRIPTION	Q.TÀ QTY
45540	SONDA ø 12 x 700 FLESSIBILE PROBE ø 12 x 700 FLEXIBLE	1
I108	VASCHETTA PORTA OGGETTI TOOL TRAY	1
F469	FRANGIFLUTTO SPASH RETAINER	3
F470	FRANGIFLUTTO SPASH RETAINER	2
F471	GRIGLIA NET	1
KC032	GRUPPO SCARICO SERBATOIO DISCHARGING GROUP	1
KC034	GRUPPO SCARICO DISCHARGING GROUP	1
KC114	MANICO A "U" HANDLE	1
KC276/VERDE	SERBATOIO 65 l RESERVOIR 65 l	1
KC293	COPPA RACCOGLI OLIO COLLECTING BASIN	1
KG001	RUBINETTO UNIVERSALE CARICA ARIA UNIVERSAL AIR TAP	1
KG079	GRUPPO GOMITO E GHIERA RING AND ELBOW JOINT GROUP	2
KG179	CONTENITORE PORTA SONDE PROBES CONTAINER	1
KG180	SILENZIATORE COMPLETO COMPLETE MUFFLER	1
S104	VUOTOMETRO ø 60 mm VACUUM GAUGE ø 60 mm	1
S215	RUBINETTO A SFERA 1/4" BALL VALVE 1/4"	1
S402	VALVOLA DI SICUREZZA 1 bar SAFETY VALVE 1 bar	1

Art. KR4651 KIT GUARNIZIONI COMPLETO COMPOSTO DALLE GUARNIZIONI SOTTO ELENCAE JOINTS GASKETS LIST INCLUDING ALL THE GASKETS SHOWN HERE UNDER		
CODICE CODE	DESCRIZIONE DESCRIPTION	Q.TÀ QTY
H034	O-RING 3156 O-RING 3156	1
H047	O-RING 2050 O-RING 2050	2
H052	O-RING 106 O-RING 106	2
H053	O-RING 2025 O-RING 2025	1
H054	O-RING 2018 O-RING 2018	3
H057	O-RING 2062 O-RING 2062	2
H059	O-RING 2037 O-RING 2037	3
H064	O-RING 3043 O-RING 3043	2
H086	O-RING 4118 O-RING 4118	4
H162	O-RING 3068 O-RING 3068	2
H202	O-RING 2043 O-RING 2043	2
H206	O-RING 3043 "VITON" O-RING 3043 "VITON"	1

Art. KS4681 SET RICAMBI CONSIGLIATI AI PUNTI VENDITA E ASSISTENZA, COMPOSTO DAI RICAMBI SOTTO ELENCAE SPARE PARTS KIT ADVISED TO THE REPAIR CENTERS. THIS KIT INCLUDES ALL THE SPARE PARTS SHOWN HERE UNDER		
CODICE CODE	DESCRIZIONE DESCRIPTION	Q.TÀ QTY
KR4204	TUBO SCARICO CON FASCETTA STRINGI TUBO DISCHARGING HOSE WITH HOSE CLAMP	1
KR4302	TUBO ASPIRAZIONE COMPLETO COMPLETE SUCTION HOSE	1
KR4604	TUBO FLESSIBILE PER SERBATIO 65 l CONNECTING HOSE FOR 65 l RESERVOIR	1
KR4651	KIT GUARNIZIONI COMPLETO COMPLETE GASKETS KIT	1
S104	VUOTOMETRO ø 60 mm VACUUM GAUGE ø 60 mm	1



Art. 42170 Mod. RO.50LP



VISTA ESPLOSA - EXPLODED VIEW



RECUPERATORE LIQUIDO ANTIGELO
A PAVIMENTO DA 50 l
ANTIFREEZE DRAINER
WITH 50 l FLOOR TANK

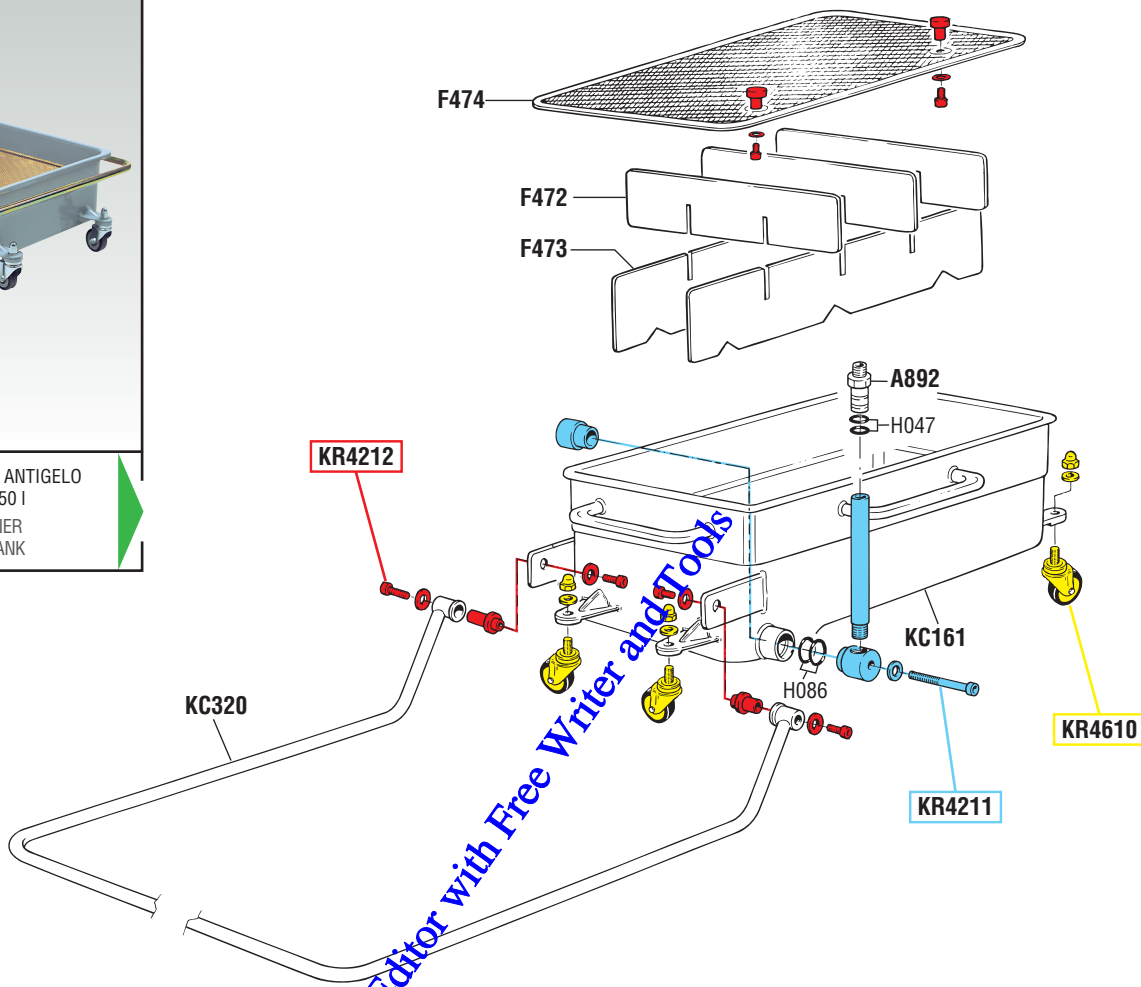

GUIDA RICAMBI - SPARE PARTS GUIDE

KIT RICAMBI

OGNI KIT SOTTO RIPORTATO COMPRENDE I RICAMBI EVIDENZIATI CON LO STESSO COLORE E LE RELATIVE GUARNIZIONI. QUESTI RICAMBI NON SONO FORNIBILI SEPARATAMENTE TRanne QUELLI CODIFICATI.

SPARE PARTS KITS

EACH KIT SHOWN WITH THE SAME COLOR INCLUDES ALSO THE GASKETS. THE SPARE PARTS INCLUDED IN THE KIT CAN'T BE SUPPLIED SEPARATELY EXCEPT THOSE SHOWN WITH A PROPER CODE.

CODICE CODE	DESCRIZIONE DESCRIPTION	Q.TÀ QTY
KR4211	ACCESSORI SCARICO DISCHARGING ACCESSORIES	1
KR4212	ACCESSORI ACCESSORIES	1
KR4610	4 RUOTE PIROETTANTI ø 60 mm - DADI 4 SWIVELING WHEELS ø 60 mm - NUTS	1

ELENCO RICAMBI FORNIBILI SINGOLARMENTE

LIST OF SPARE PARTS WHICH CAN BE SUPPLIED SEPARATELY

CODICE CODE	DESCRIZIONE DESCRIPTION	Q.TÀ QTY
A892	RACCORDO CONNECTION	1
F472	FRANGIFLUTTO SPLASH RETAINER	3
F473	FRANGIFLUTTO SPLASH RETAINER	2
F474	GRIGLIA NET	2
H047	O-RING 2050 O-RING 2050	2
H086	O-RING 4118 O-RING 4118	1
KC161	COPPA RACCOGLI OLIO COLLECTING BASIN	1
KC320	MANICO MOBILE MOVABLE HANDLE	1

tutti i diritti riservati - all rights reserved



tecnologia qualità & funzionalità
technology, quality, functionality

PDFFill PDF Editor with Free Writer and Tools

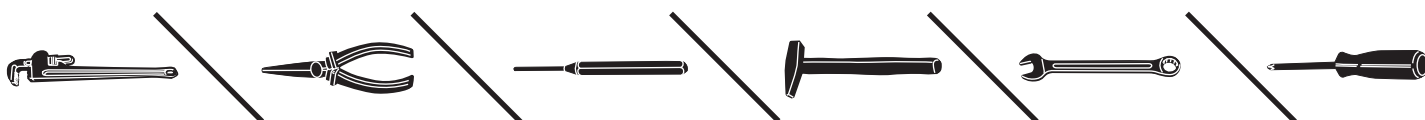



GUIDA RICAMBI - SPARE PARTS GUIDE

KIT RICAMBI OGNI KIT SOTTO RIPORTATO COMPRENDE I RICAMBI EVIDENZIATI CON LO STESSO COLORE E LE RELATIVE GUARNIZIONI. QUESTI RICAMBI NON SONO FORNIBILI SEPARATAMENTE TRANNE QUELLI CODIFICATI.		
SPARE PARTS KITS EACH KIT SHOWN WITH THE SAME COLOR INCLUDES ALSO THE GASKETS. THE SPARE PARTS INCLUDED IN THE KIT CAN'T BE SUPPLIED SEPARATELY EXCEPT THOSE SHOWN WITH A PROPER CODE.		
CODICE CODE	DESCRIZIONE DESCRIPTION	Q.TÀ QTY
KR4203	GRUPPO RUBINETTO-VALVOLA DI SICUREZZA AIR TAP AND SAFETY VALVE GROUP	1
KR4204	TUBO SCARICO CON FASCETTA STRINGI TUBO DISCHARGING HOSE WITH HOSE CLAMP	1
KR4205	SET DI VITI PER SERBATOIO SET OF SCREWS FOR RESERVOIR	1
KR4302	TUBO ASPIRAZIONE COMPLETO COMPLETE SUCTION HOSE	1
KR4304	GRUPPO ASPIRAZIONE CON RUBINETTO SUCTION GROUP WITH TAP	1
KR4607	TUBO FLESSIBILE PER SERBATOIO 115 l CONNECTING HOSE FOR 115 l RESERVOIR	1
KR4608	TUBO LIVELLO CON ETICHETTA GAUGE TUBE WITH LABEL	1
KR4609	KIT QUATTRO BRACCIA PER RECUP. A PANTOG. FOUR ARMS KIT FOR PANTOGRAPH DRAINER	1
KR4610	4 RUOTE PIROETTANTI ø 60 mm - DADI 4 SWIVELING WHEELS ø 60 mm - NUTS	1
KR4611	SET VITI PER BRACCI PANTOGRAFO SET OF SCREWS FOR PANTOGRAPH ARMS	1
KR4612	TAPPO RIDUTTORE ASPIRAZIONE CAMION SUCTION REDUCING PLUG FOR TRUCK	1
KR4613	2 RUOTE PIROETTANTI CON FRENO - DADI 2 SWIVELLING WHEELS WITH BRAKE - NUTS	1
KR4614	2 RUOTE FISSE CON ANELLI ELASTICI 2 FIXED WHEELS WITH RETAINING RINGS	1

ELENCO RICAMBI FORNIBILI SINGOLARMENTE LIST OF SPARE PARTS WHICH CAN BE SUPPLIED SEPARATELY		
CODICE CODE	DESCRIZIONE DESCRIPTION	Q.TÀ QTY
45540	SONDA ø 12 x 700 FLESSIBILE PROBE ø 12 x 700 FLEXIBLE	1
I108	VASCHETTA PORTA OGGETTI TOOL TRAY	1
F472	FRANGIFLUTTO SPLASH RETAINER	3
F473	FRANGIFLUTTO SPLASH RETAINER	2
F474	GRIGLIA NET	1
KC027	MANICO A "U" HANDLE	1
KC032	GRUPPO SCARICO SERBATOIO DISCHARGING GROUP	1
KC034	GRUPPO SCARICO DISCHARGING GROUP	1
KC161	COPPA RACCOGLI OLIO COLLECTING BASIN	1
KC257/VERDE	SERBATOIO 115 l RESERVOIR 115 l	1
KG001	RUBINETTO UNIVERSALE CARICA ARIA UNIVERSAL AIR TAP	1
KG079	GRUPPO GOMITO E GHIERA RING AND ELBOW JOINT GROUP	2
KG179	CONTENITORE PORTA SONDE PROBES CONTAINER	1
KG180	SILENZIATORE COMPLETO COMPLETE MUFFLER	1
S104	VUOTOMETRO ø 60 mm VACUUM GAUGE ø 60 mm	1
S215	RUBINETTO A SFERA 1/4" BALL VALVE 1/4"	1
S402	VALVOLA DI SICUREZZA 1 bar SAFETY VALVE 1 bar	1

Art. KR4651 KIT GUARNIZIONI COMPLETO COMPOSTO DALLE GUARNIZIONI SOTTO ELENCAE JOINTS GASKETS LIST INCLUDING ALL THE GASKETS SHOWN HERE UNDER		
CODICE CODE	DESCRIZIONE DESCRIPTION	Q.TÀ QTY
H034	O-RING 3156 O-RING 3156	1
H047	O-RING 2050 O-RING 2050	2
H052	O-RING 106 O-RING 106	2
H053	O-RING 2025 O-RING 2025	1
H054	O-RING 2018 O-RING 2018	3
H057	O-RING 2062 O-RING 2062	2
H059	O-RING 2037 O-RING 2037	3
H064	O-RING 3043 O-RING 3043	2
H086	O-RING 4118 O-RING 4118	4
H162	O-RING 3068 O-RING 3068	2
H202	O-RING 2043 O-RING 2043	2
H206	O-RING 3043 "VITON" O-RING 3043 "VITON"	1

Art. KS4683 SET RICAMBI CONSIGLIATI AI PUNTI VENDITA E ASSISTENZA, COMPOSTO DAI RICAMBI SOTTO ELENCAE SPARE PARTS KIT ADVISED TO THE REPAIR CENTERS. THIS KIT INCLUDES ALL THE SPARE PARTS SHOWN HERE UNDER		
CODICE CODE	DESCRIZIONE DESCRIPTION	Q.TÀ QTY
KR4204	TUBO SCARICO CON FASCETTA STRINGI TUBO DISCHARGING HOSE WITH HOSE CLAMP	1
KR4302	TUBO ASPIRAZIONE COMPLETO COMPLETE SUCTION HOSE	1
KR4607	TUBO FLESSIBILE PER SERBATOIO 115 l CONNECTING HOSE FOR 115 l RESERVOIR	1
KR4651	KIT GUARNIZIONI COMPLETO COMPLETE GASKETS KIT	1
S104	VUOTOMETRO ø 60 mm VACUUM GAUGE ø 60 mm	1

PDFill PDF Editor with Free Writer and Tools



Art. 43016 Mod. AO.16L



VISTA ESPLOSA - EXPLODED VIEW



ASPIRATORE PNEUMATICO OLIO ESAUSTO CON SERBATOIO PORTABILE DA 16 l
AIR-OPERATED WASTE OIL DRAINER WITH PORTABLE 16 l TANK

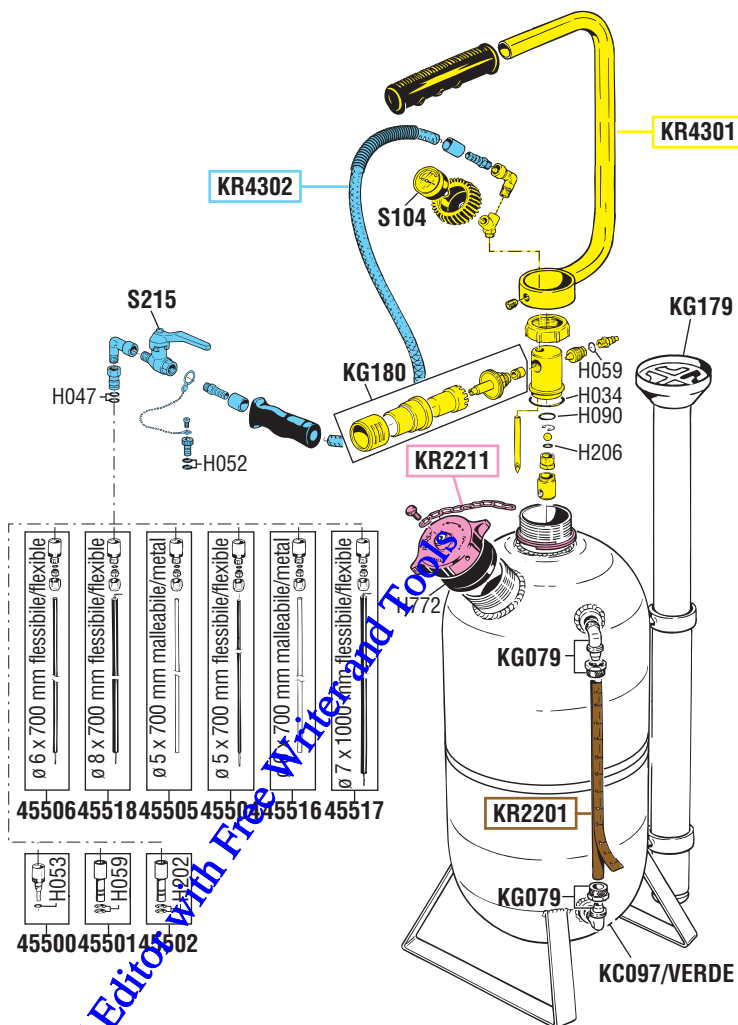

- ø 6 x 700 mm flessibile/flexible 45506
- ø 8 x 700 mm flessibile/flexible 45518
- ø 5 x 700 mm malleabile/metal 45505
- ø 5 x 700 mm flessibile/flexible 45504
- ø 5 x 700 mm malleabile/metal 45516
- ø 7 x 1000 mm flessibile/flexible 45517

GUIDA RICAMBI - SPARE PARTS GUIDE

KIT RICAMBI		
OGNI KIT SOTTO RIPORTATO COMPRENDE I RICAMBI EVIDENZIATI CON LO STESSO COLORE E LE RELATIVE GUARNIZIONI. QUESTI RICAMBI NON SONO FORNIBILI SEPARATAMENTE TRANNE QUELLI CODIFICATI.		
SPARE PARTS KITS		
EACH KIT SHOWN WITH THE SAME COLOR INCLUDES ALSO THE GASKETS. THE SPARE PARTS INCLUDED IN THE KIT CAN'T BE SUPPLIED SEPARATELY EXCEPT THOSE SHOWN WITH A PROPER CODE.		
CODICE CODE	DESCRIZIONE DESCRIPTION	Q.TÀ QTY
KR2201	TUBO DI LIVELLO ED ETICHETTA GAUGE TUBE AND LABEL	1
KR2211	TAPPO ALTA PRESSIONE HIGH PRESSURE PLUG	1
KR4301	GRUPPO ASPIRATORE E MANICO SUCTION GROUP AND HANDLE	1
KR4302	TUBO ASPIRAZIONE COMPLETO COMPLETE SUCTION HOSE	1

ELENCO RICAMBI FORNIBILI SINGOLARMENTE		
LIST OF SPARE PARTS WHICH CAN BE SUPPLIED SEPARATELY		
CODICE CODE	DESCRIZIONE DESCRIPTION	Q.TÀ QTY
45500	RACCORDO PER SONDE (VOLKSWAGEN) CONNECTOR FOR PROBES (VOLKSWAGEN)	1
45501	RACCORDO PER SONDE (BMW) CONNECTOR FOR PROBES (BMW)	1
45502	RACCORDO PER SONDE (CITROEN) CONNECTOR FOR PROBES (CITROEN)	1
45504	SONDA ø 5 x 700 FLESSIBILE PROBE ø 5 x 700 FLEXIBLE	1
45505	SONDA ø 5 x 700 METALLO-MALLEABILE PROBE ø 5 x 700 MALLEABLE METAL	1
45506	SONDA ø 6 x 700 FLESSIBILE PROBE ø 6 x 700 FLEXIBLE	1
45516	SONDA ø 6 x 700 METALLO-MALLEABILE PROBE ø 6 x 700 MALLEABLE METAL	1
45517	SONDA ø 7 x 1000 FLESSIBILE PROBE ø 7 x 1000 FLEXIBLE	1
45518	SONDA ø 8 x 700 FLESSIBILE PROBE ø 8 x 700 FLEXIBLE	1
KC097/VERDE	SERBATOIO 16 l RESERVOIR 16 l	1
KG079	GRUPPO GOMITO E GHIERA RING AND ELBOW JOINT GROUP	2
KG179	CONTENITORE PORTA SONDE PROBES CONTAINER	1
KG180	SILENZIATORE COMPLETO COMPLETE MUFFLER	1
S104	VUOTOMETRO ø 60 mm VACUUM GAUGE ø 60 mm	1
S215	RUBINETTO A SFERA 1/4" BALL VALVE 1/4"	1

KIT GUARNIZIONI COMPLETO		
COMPOSTO DALLE GUARNIZIONI SOTTO ELENCAE JOINTS GASKETS LIST INCLUDING ALL THE GASKETS SHOWN HERE UNDER		
Art. KR4350	DESCRIZIONE DESCRIPTION	Q.TÀ QTY
H034	O-RING 3156 O-RING 3156	1
H047	O-RING 2050 O-RING 2050	2
H052	O-RING 106 O-RING 106	2
H053	O-RING 2025 O-RING 2025	1
H059	O-RING 2037 O-RING 2037	3
H090	O-RING 3056 O-RING 3056	1
H202	O-RING 2043 O-RING 2043	2
H206	O-RING 3043 "VITON" O-RING 3043 "VITON"	1
H772	GUARNIZIONE TAPPO GASKET	1
Art. KS4380		
SET RICAMBI CONSIGLIATI AI PUNTI VENDITA E ASSISTENZA, COMPOSTO DAI RICAMBI SOTTO ELENCATI		
SPARE PARTS KIT ADVISED TO THE REPAIR CENTERS. THIS KIT INCLUDES ALL THE SPARE PARTS SHOWN HERE UNDER		
Art. KR4350	DESCRIZIONE DESCRIPTION	Q.TÀ QTY
KR4302	TUBO ASPIRAZIONE COMPLETO COMPLETE SUCTION HOSE	1
KR4350	KIT GUARNIZIONI COMPLETO COMPLETE GASKETS KIT	1
S104	VUOTOMETRO ø 60 mm VACUUM GAUGE ø 60 mm	1

tutti i diritti riservati - all rights reserved



Art. 43024 Mod. AO.24L



VISTA ESPLOSA - EXPLODED VIEW



ASPIRATORE PNEUMATICO OLIO ESAUSTO CON SERBATOIO PORTABILE DA 24 l
AIR-OPERATED WASTE OIL DRAINER WITH PORTABLE 24 l TANK

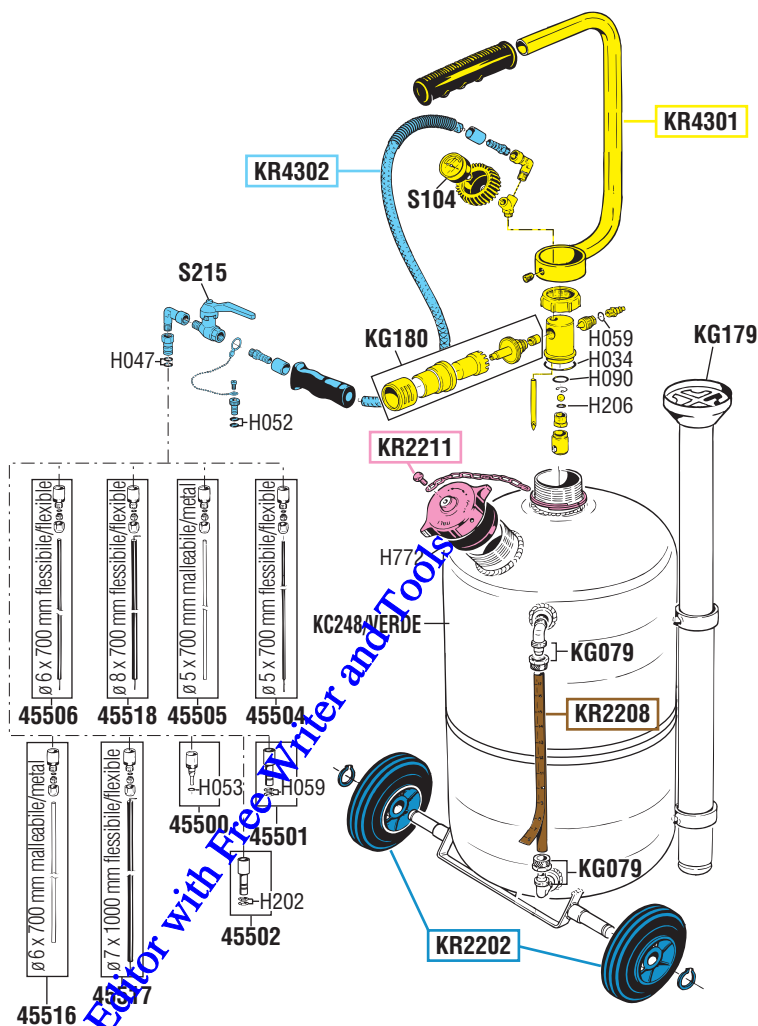

GUIDA RICAMBI - SPARE PARTS GUIDE

KIT RICAMBI
OGNI KIT SOTTO RIPORTATO COMPRENDE I RICAMBI EVIDENZIATI CON LO STESSO COLORE E LE RELATIVE GUARNIZIONI. QUESTI RICAMBI NON SONO FORNIBILI SEPARATAMENTE TRANNE QUELLI CODIFICATI.
SPARE PARTS KITS
EACH KIT SHOWN WITH THE SAME COLOR INCLUDES ALSO THE GASKETS. THE SPARE PARTS INCLUDED IN THE KIT CAN'T BE SUPPLIED SEPARATELY EXCEPT THOSE SHOWN WITH A PROPER CODE.

CODICE CODE	DESCRIZIONE DESCRIPTION	Q.TÀ QTY
KR2202	DUE RUOTE FISSE CON ANELLI ELASTICI TWO FIXED WHEELS WITH RETAINING RINGS	1
KR2208	TUBO DI LIVELLO CON ETICHETTA GAUGE TUBE WITH LABEL	1
KR2211	TAPPO ALTA PRESSIONE HIGH PRESSURE PLUG	1
KR4301	GRUPPO ASPIRATORE E MANICO SUCTION GROUP AND HANDLE	1
KR4302	TUBO ASPIRAZIONE COMPLETO COMPLETE SUCTION HOSE	1

ELENCO RICAMBI FORNIBILI SINGOLARMENTE
LIST OF SPARE PARTS WHICH CAN BE SUPPLIED SEPARATELY

CODICE CODE	DESCRIZIONE DESCRIPTION	Q.TÀ QTY
45500	RACCORDO PER SONDE (VOLKSWAGEN) CONNECTOR FOR PROBES (VOLKSWAGEN)	1
45501	RACCORDO PER SONDE (BMW) CONNECTOR FOR PROBES (BMW)	1
45502	RACCORDO PER SONDE (CITROEN) CONNECTOR FOR PROBES (CITROEN)	1
45504	SONDA ø 5 x 700 FLESSIBILE PROBE ø 5 x 700 FLEXIBLE	1
45505	SONDA ø 5 x 700 METALLO-MALLEABILE PROBE ø 5 x 700 MALLEABLE METAL	1
45506	SONDA ø 6 x 700 FLESSIBILE PROBE ø 6 x 700 FLEXIBLE	1
45516	SONDA ø 6 x 700 METALLO-MALLEABILE PROBE ø 6 x 700 MALLEABLE METAL	1
45517	SONDA ø 7 x 1000 FLESSIBILE PROBE ø 7 x 1000 FLEXIBLE	1
45518	SONDA ø 8 x 700 FLESSIBILE PROBE ø 8 x 700 FLEXIBLE	1
KC248/VERDE	SERBATOIO 24 l RESERVOIR 24 l	1
KG079	GRUPPO GOMITO E GHIERA RING AND ELBOW JOINT GROUP	2
KG179	CONTENITORE PORTA SONDE PROBES CONTAINER	1
KG180	SILENZIATORE COMPLETO COMPLETE MUFFLER	1
S104	VUOTOMETRO ø 60 mm VACUUM GAUGE ø 60 mm	1
S215	RUBINETTO A SFERA 1/4" BALL VALVE 1/4"	1

Art. KR4350
KIT GUARNIZIONI COMPLETO
COMPOSTO DALLE GUARNIZIONI SOTTO ELENCAE
JOINTS GASKETS LIST
INCLUDING ALL THE GASKETS SHOWN HERE UNDER

CODICE CODE	DESCRIZIONE DESCRIPTION	Q.TÀ QTY
H034	O-RING 3156 O-RING 3156	1
H047	O-RING 2050 O-RING 2050	2
H052	O-RING 106 O-RING 106	2
H053	O-RING 2025 O-RING 2025	1
H059	O-RING 2037 O-RING 2037	3
H090	O-RING 3056 O-RING 3056	1
H202	O-RING 2043 O-RING 2043	2
H206	O-RING 3043 "VITON" O-RING 3043 "VITON"	1
H772	GUARNIZIONE TAPPO GASKET	1

Art. KS4380
SET RICAMBI CONSIGLIATI
AI PUNTI VENDITA E ASSISTENZA,
COMPOSTO DAI RICAMBI SOTTO ELENCAE
SPARE PARTS KIT ADVISED
TO THE REPAIR CENTERS. THIS KIT INCLUDES
ALL THE SPARE PARTS SHOWN HERE UNDER

CODICE CODE	DESCRIZIONE DESCRIPTION	Q.TÀ QTY
KR4302	TUBO ASPIRAZIONE COMPLETO COMPLETE SUCTION HOSE	1
KR4350	KIT GUARNIZIONI COMPLETO COMPLETE GASKETS KIT	1
S104	VUOTOMETRO ø 60 mm VACUUM GAUGE ø 60 mm	1

tutti i diritti riservati - all rights reserved



Art. 43060 Mod. AO.60 L



VISTA ESPLOSA - EXPLODED VIEW



ASPIRATORE PNEUMATICO OLIO ESAUSTO DA 65 l
AIR-OPERATED WASTE OIL DRAINER
65 l TANK

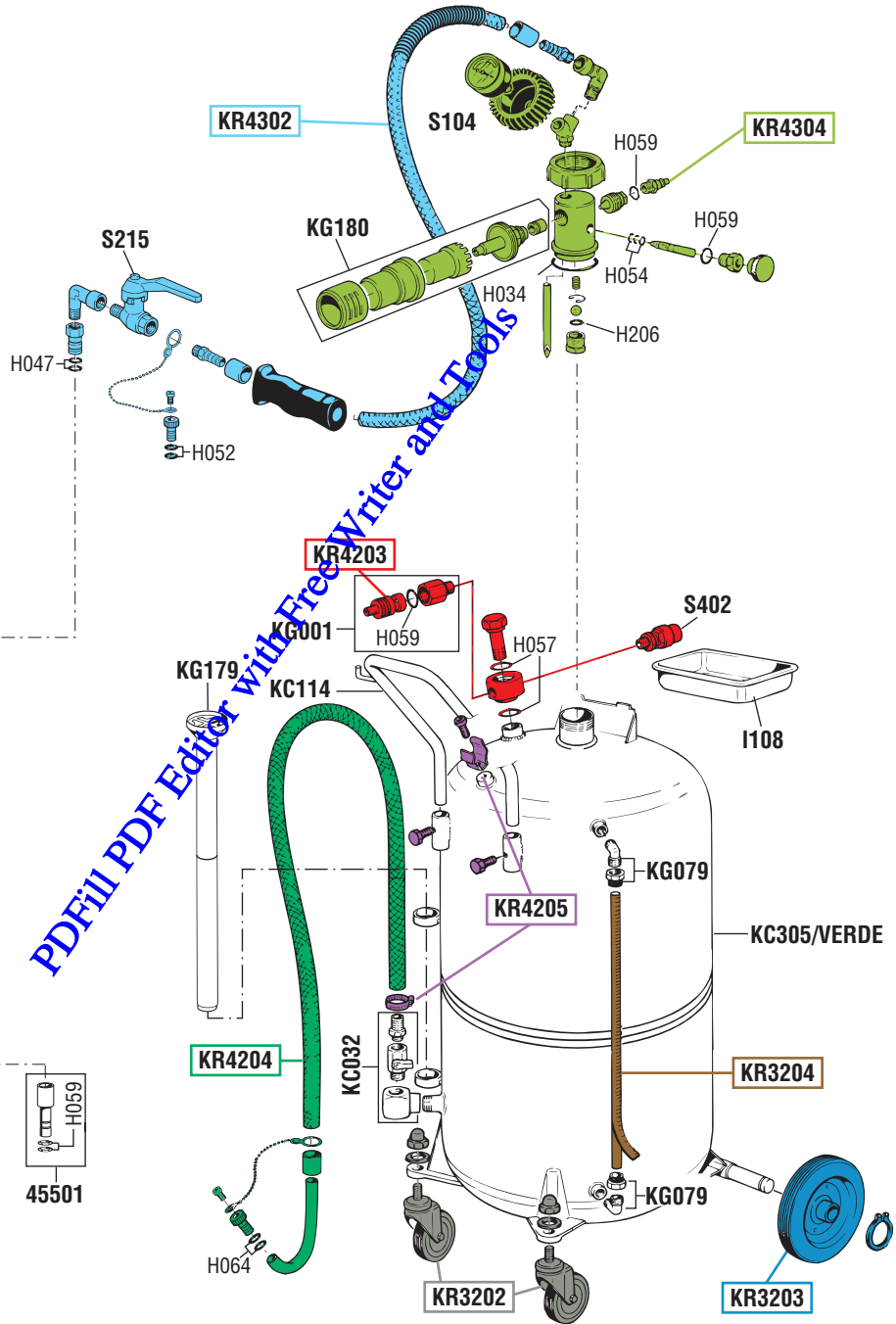

- ø 6 x 700 mm flessibile/flexible 45506
- ø 8 x 700 mm flessibile/flexible 45518
- ø 5 x 700 mm malleabile/metal 45505
- ø 5 x 700 mm flessibile/flexible 45504
- ø 6 x 700 mm malleabile/metal 45516
- ø 7 x 1000 mm flessibile/flexible 45517
- H053 45500
- H202 45502
- H059 45501

PDFfill PDF Editor with Free Writer and Tools

tutti i diritti riservati - all rights reserved



GUIDA RICAMBI - SPARE PARTS GUIDE

KIT RICAMBI OGNI KIT SOTTO RIPORTATO COMPRENDE I RICAMBI EVIDENZIATI CON LO STESSO COLORE E LE RELATIVE GUARNIZIONI. QUESTI RICAMBI NON SONO FORNIBILI SEPARATAMENTE TRANNE QUELLI CODIFICATI.		
SPARE PARTS KITS EACH KIT SHOWN WITH THE SAME COLOR INCLUDES ALSO THE GASKETS. THE SPARE PARTS INCLUDED IN THE KIT CAN'T BE SUPPLIED SEPARATELY EXCEPT THOSE SHOWN WITH A PROPER CODE.		
CODICE CODE	DESCRIZIONE DESCRIPTION	Q. TÀ QTY
KR3202	DUE RUOTE PIROETTANTI CON DADI TWO SWIVELLING WHEELS WITH NUTS	1
KR3203	2 RUOTE FISSE CON ANELLI ELASTICI 2 FIXED WHEELS WITH RETAINING RINGS	1
KR3204	TUBO DI LIVELLO ED ETICHETTA GAUGE TUBE AND LABEL	1
KR4203	GRUPPO RUBINETTO-VALVOLA DI SICUREZZA AIR TAP AND SAFETY VALVE GROUP	1
KR4204	TUBO SCARICO CON FASCETTA STRINGI TUBO DISCHARGING HOSE WITH HOSE CLAMP	1
KR4205	SET DI VITI PER SERBATOIO SET OF SCREWS FOR RESERVOIR	1
KR4302	TUBO ASPIRAZIONE COMPLETO COMPLETE SUCTION HOSE	1
KR4304	GRUPPO ASPIRAZIONE CON RUBINETTO SUCTION GROUP WITH TAP	1

ELENCO RICAMBI FORNIBILI SINGOLARMENTE LIST OF SPARE PARTS WHICH CAN BE SUPPLIED SEPARATELY		
CODICE CODE	DESCRIZIONE DESCRIPTION	Q. TÀ QTY
45500	RACCORDO PER SONDE (VOLKSWAGEN) CONNECTOR FOR PROBES (VOLKSWAGEN)	1
45501	RACCORDO PER SONDE (BMW) CONNECTOR FOR PROBES (BMW)	1
45502	RACCORDO PER SONDE (CITROEN) CONNECTOR FOR PROBES (CITROEN)	1
45504	SONDA ø 5 x 700 FLESSIBILE PROBE ø 5 x 700 FLEXIBLE	1
45505	SONDA ø 5 x 700 METALLO-MALLEABILE PROBE ø 5 x 700 MALLEABLE METAL	1
45506	SONDA ø 6 x 700 FLESSIBILE PROBE ø 6 x 700 FLEXIBLE	1
45516	SONDA ø 6 x 700 METALLO-MALLEABILE PROBE ø 6 x 700 MALLEABLE METAL	1
45517	SONDA ø 7 x 1000 FLESSIBILE PROBE ø 7 x 1000 FLEXIBLE	1
45518	SONDA ø 8 x 700 FLESSIBILE PROBE ø 8 x 700 FLEXIBLE	1
I108	VASCHETTA PORTA OGGETTI TOOL TRAY	1
KC032	GRUPPO SCARICO SERBATOIO DISCHARGING GROUP	1
KC114	MANICO A "U" HANDLE	1
KC305/VERDE	SERBATOIO 65 l RESERVOIR 65 l	1
KG001	RUBINETTO UNIVERSALE CARICA ARIA UNIVERSAL AIR TAP	1
KG079	GRUPPO GOMITO E GHIERA RING AND ELBOW JOINT GROUP	2
KG179	CONTENITORE PORTA SONDE PROBES CONTAINER	1
KG180	SILENZIATORE COMPLETO COMPLETE MUFFLER	1
S104	VUOTOMETRO ø 60 mm VACUUM GAUGE ø 60 mm	1
S215	RUBINETTO A SFERA 1/4" BALL VALVE 1/4"	1
S402	VALVOLA DI SICUREZZA 1 bar SAFETY VALVE 1 bar	1

Art. KR4351 KIT GUARNIZIONI COMPLETO COMPOSTO DALLE GUARNIZIONI SOTTO ELENcate JOINTS GASKETS LIST INCLUDING ALL THE GASKETS SHOWN HERE UNDER		
CODICE CODE	DESCRIZIONE DESCRIPTION	Q. TÀ QTY
H034	O-RING 3156 O-RING 3156	1
H047	O-RING 2050 O-RING 2050	2
H052	O-RING 106 O-RING 106	2
H053	O-RING 2025 O-RING 2025	1
H054	O-RING 2018 O-RING 2018	3
H057	O-RING 2062 O-RING 2062	2
H059	O-RING 2037 O-RING 2037	5
H064	O-RING 3043 O-RING 3043	2
H202	O-RING 2043 O-RING 2043	2
H206	O-RING 3043 "VITON" O-RING 3043 "VITON"	1

Art. KS4381 SET RICAMBI CONSIGLIATI AI PUNTI VENDITA E ASSISTENZA, COMPOSTO DAI RICAMBI SOTTO ELENcati SPARE PARTS KIT ADVISED TO THE REPAIR CENTERS. THIS KIT INCLUDES ALL THE SPARE PARTS SHOWN HERE UNDER		
CODICE CODE	DESCRIZIONE DESCRIPTION	Q. TÀ QTY
KR4204	TUBO SCARICO CON FASCETTA STRINGI TUBO DISCHARGING HOSE WITH HOSE CLAMP	1
KR4302	TUBO ASPIRAZIONE COMPLETO COMPLETE SUCTION HOSE	1
KR4351	KIT GUARNIZIONI COMPLETO COMPLETE GASKETS KIT	1
S104	VUOTOMETRO ø 60 mm VACUUM GAUGE ø 60 mm	1

PDFill PDF Editor with Free Writer and Tools



Art. 43065 Mod. AO.65L



VISTA ESPLOSA - EXPLODED VIEW

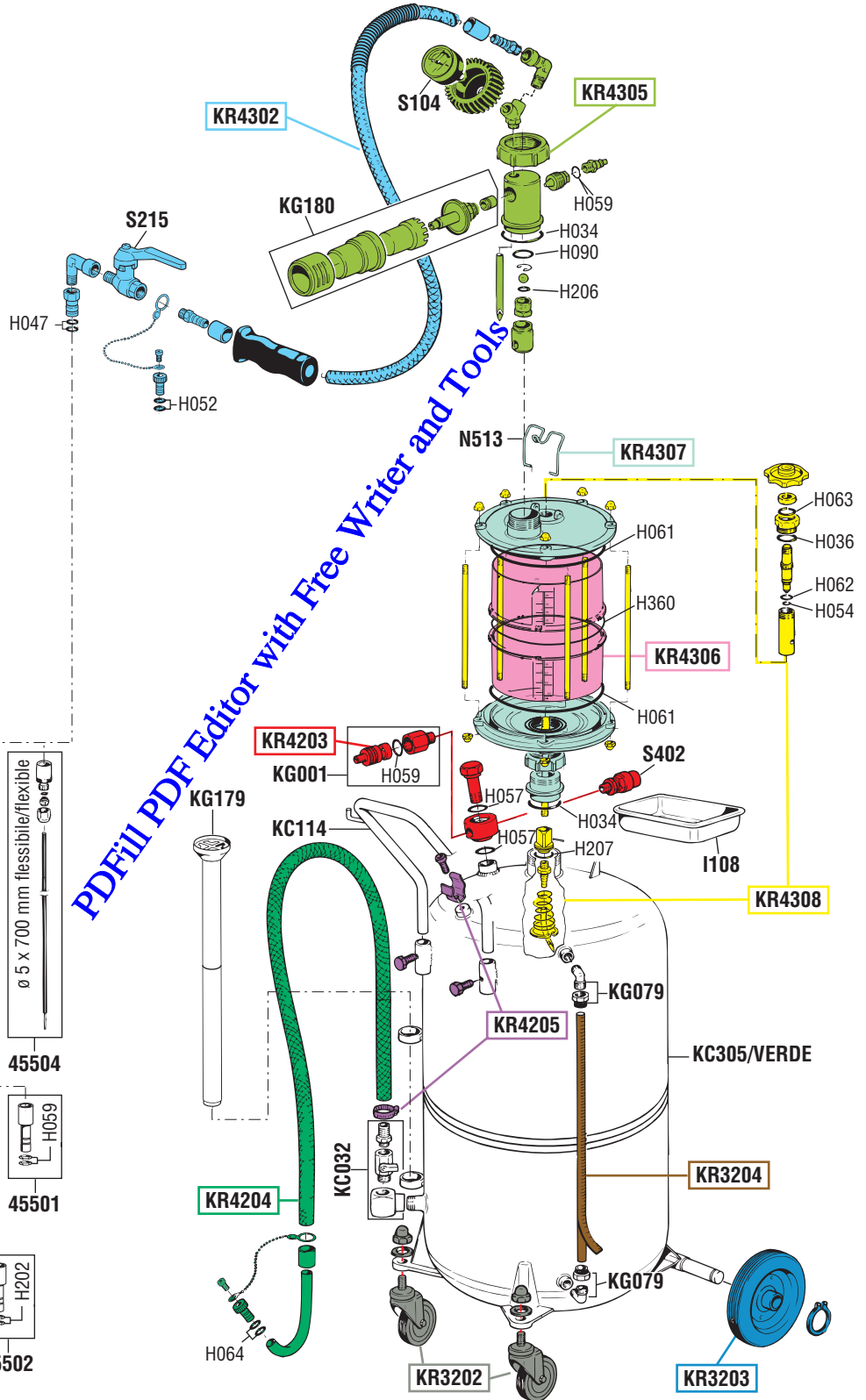

PDFfill PDF Editor with Free Writer and Tools

- ø 6 x 700 mm flessibile/flexible 45506
- ø 8 x 700 mm flessibile/flexible 45518
- ø 5 x 700 mm malleabile/metal 45505
- ø 5 x 700 mm flessibile/flexible 45504
- ø 6 x 700 mm malleabile/metal 45516
- ø 7 x 1000 mm flessibile/flexible 45517
- H053 45500
- H059 45501
- H202 45502

tutti i diritti riservati - all rights reserved



GUIDA RICAMBI - SPARE PARTS GUIDE

KIT RICAMBI
OGNI KIT SOTTO RIPORTATO COMPRENDE I RICAMBI EVIDENZIATI CON LO STESSO COLORE E LE RELATIVE GUARNIZIONI. QUESTI RICAMBI NON SONO FORNIBILI SEPARATAMENTE TRANNE QUELLI CODIFICATI.

SPARE PARTS KITS

EACH KIT SHOWN WITH THE SAME COLOR INCLUDES ALSO THE GASKETS. THE SPARE PARTS INCLUDED IN THE KIT CAN'T BE SUPPLIED SEPARATELY EXCEPT THOSE SHOWN WITH A PROPER CODE.

CODICE CODE	DESCRIZIONE DESCRIPTION	Q.TÀ QTY
KR3202	DUE RUOTE PIROETTANTI CON DADI TWO SWIVELLING WHEELS WITH NUTS	1
KR3203	2 RUOTE FISSE CON ANELLI ELASTICI 2 FIXED WHEELS WITH RETAINING RINGS	1
KR3204	TUBO DI LIVELLO ED ETICHETTA GAUGE TUBE AND LABEL	1
KR4203	GRUPPO RUBINETTO-VALVOLA DI SICUREZZA AIR TAP AND SAFETY VALVE GROUP	1
KR4204	TUBO SCARICO CON FASCETTA STRINGI TUBO DISCHARGING HOSE WITH HOSE CLAMP	1
KR4205	SET DI VITI PER SERBATOIO SET OF SCREWS FOR RESERVOIR	1
KR4302	TUBO ASPIRAZIONE COMPLETO COMPLETE SUCTION HOSE	1
KR4305	GRUPPO ASPIRAZIONE COMPLETO COMPLETE SUCTION GROUP	1
KR4306	CILINDRO - 2 O-RING - ETICHETTA CYLINDER - 2 O-RING - LABEL	1
KR4307	DUE FLANGE PRECAMERA TWO TRANSPARENT BOWL FLANGES	1
KR4308	ACCESSORI PRECAMERA TRANSPARENT BOWL ACCESSORIES	1

ELENCO RICAMBI FORNIBILI SINGOLARMENTE

LIST OF SPARE PARTS WHICH CAN BE SUPPLIED SEPARATELY

CODICE CODE	DESCRIZIONE DESCRIPTION	Q.TÀ QTY
45500	RACCORDO PER SONDE (VOLKSWAGEN) CONNECTOR FOR PROBES (VOLKSWAGEN)	1
45501	RACCORDO PER SONDE (BMW) CONNECTOR FOR PROBES (BMW)	1
45502	RACCORDO PER SONDE (CITROEN) CONNECTOR FOR PROBES (CITROEN)	1
45504	SONDA ø 5 x 700 FLESSIBILE PROBE ø 5 x 700 FLEXIBLE	1
45505	SONDA ø 5 x 700 METALLO-MALLEABILE PROBE ø 5 x 700 MALLEABLE METAL	1
45506	SONDA ø 6 x 700 FLESSIBILE PROBE ø 6 x 700 FLEXIBLE	1
45516	SONDA ø 6 x 700 METALLO-MALLEABILE PROBE ø 6 x 700 MALLEABLE METAL	1
45517	SONDA ø 7 x 1000 FLESSIBILE PROBE ø 7 x 1000 FLEXIBLE	1
45518	SONDA ø 8 x 700 FLESSIBILE PROBE ø 8 x 700 FLEXIBLE	1
I108	VASCHETTA PORTA OGGETTI TOOL TRAY	1
KC032	GRUPPO SCARICO SERBATOIO DISCHARGING GROUP	1
KC114	MANICO A "U" HANDLE	1
KC305/VERDE	SERBATOIO 65 l RESERVOIR 65 l	1
KG001	RUBINETTO UNIVERSALE CARICA ARIA UNIVERSAL AIR TAP	1
KG079	GRUPPO GOMITO E GHIERA RING AND ELBOW JOINT GROUP	2
KG179	CONTENITORE PORTA SONDE PROBES CONTAINER	1
KG180	SILENZIATORE COMPLETO COMPLETE MUFFLER	1
N513	LEVA BLOCCA PULSANTE PRECAMERA PRECHAMBER HOOKING LEVER	1
S104	VUOTOMETRO ø 60 mm VACUUM GAUGE ø 60 mm	1
S215	RUBINETTO A SFERA BALL VALVE 1/4"	1
S402	VALVOLA DI SICUREZZA 1 bar SAFETY VALVE 1 bar	1

Art. KR4352
KIT GUARNIZIONI COMPLETO
COMPOSTO DALLE GUARNIZIONI SOTTO ELENcate
JOINTS GASKETS LIST
INCLUDING ALL THE GASKETS SHOWN HERE UNDER

CODICE CODE	DESCRIZIONE DESCRIPTION	Q.TÀ QTY
H034	O-RING 3156 O-RING 3156	2
H036	O-RING 3093 O-RING 3093	1
H047	O-RING 2050 O-RING 2050	2
H052	O-RING 106 O-RING 106	2
H053	O-RING 2025 O-RING 2025	1
H054	O-RING 2018 O-RING 2018	1
H057	O-RING 2062 O-RING 2062	2
H059	O-RING 2037 O-RING 2037	4
H061	O-RING 4750 O-RING 4750	2
H062	O-RING 109 "NBR 70" O-RING 109 "NBR 70"	1
H063	O-RING 4081 O-RING 4081	1
H064	O-RING 3043 O-RING 3043	2
H090	O-RING 3056 O-RING 3056	1
H202	O-RING 2043 O-RING 2043	2
H206	O-RING 3043 "VITON" O-RING 3043 "VITON"	1
H207	O-RING 4093 "VITON" O-RING 4093 "VITON"	1
H360	O-RING 3775 "NBR 70" O-RING 3775 "NBR 70"	1

Art. KS4382
SET RICAMBI CONSIGLIATI
AI PUNTI VENDITA E ASSISTENZA,
COMPOSTO DAI RICAMBI SOTTO ELENcati
SPARE PARTS KIT ADVISED
TO THE REPAIR CENTERS. THIS KIT INCLUDES
ALL THE SPARE PARTS SHOWN HERE UNDER

CODICE CODE	DESCRIZIONE DESCRIPTION	Q.TÀ QTY
KR4204	TUBO SCARICO CON FASCETTA STRINGI TUBO DISCHARGING HOSE WITH HOSE CLAMP	1
KR4302	TUBO ASPIRAZIONE COMPLETO COMPLETE SUCTION HOSE	1
KR4306	CILINDRO - 2 O-RING - ETICHETTA CYLINDER - 2 O-RING - LABEL	1
KR4352	KIT GUARNIZIONI COMPLETO COMPLETE GASKETS KIT	1
S104	VUOTOMETRO ø 60 mm VACUUM GAUGE ø 60 mm	1

RAASM

FLUIDS AND LUBRICATION EQUIPMENT



Art. 43090 Mod. AO.90L



VISTA ESPLOSA - EXPLODED VIEW



ASPIRATORE PNEUMATICO OLIO ESAUSTO DA 90 L
AIR-OPERATED WASTE OIL DRAINER 90 L TANK

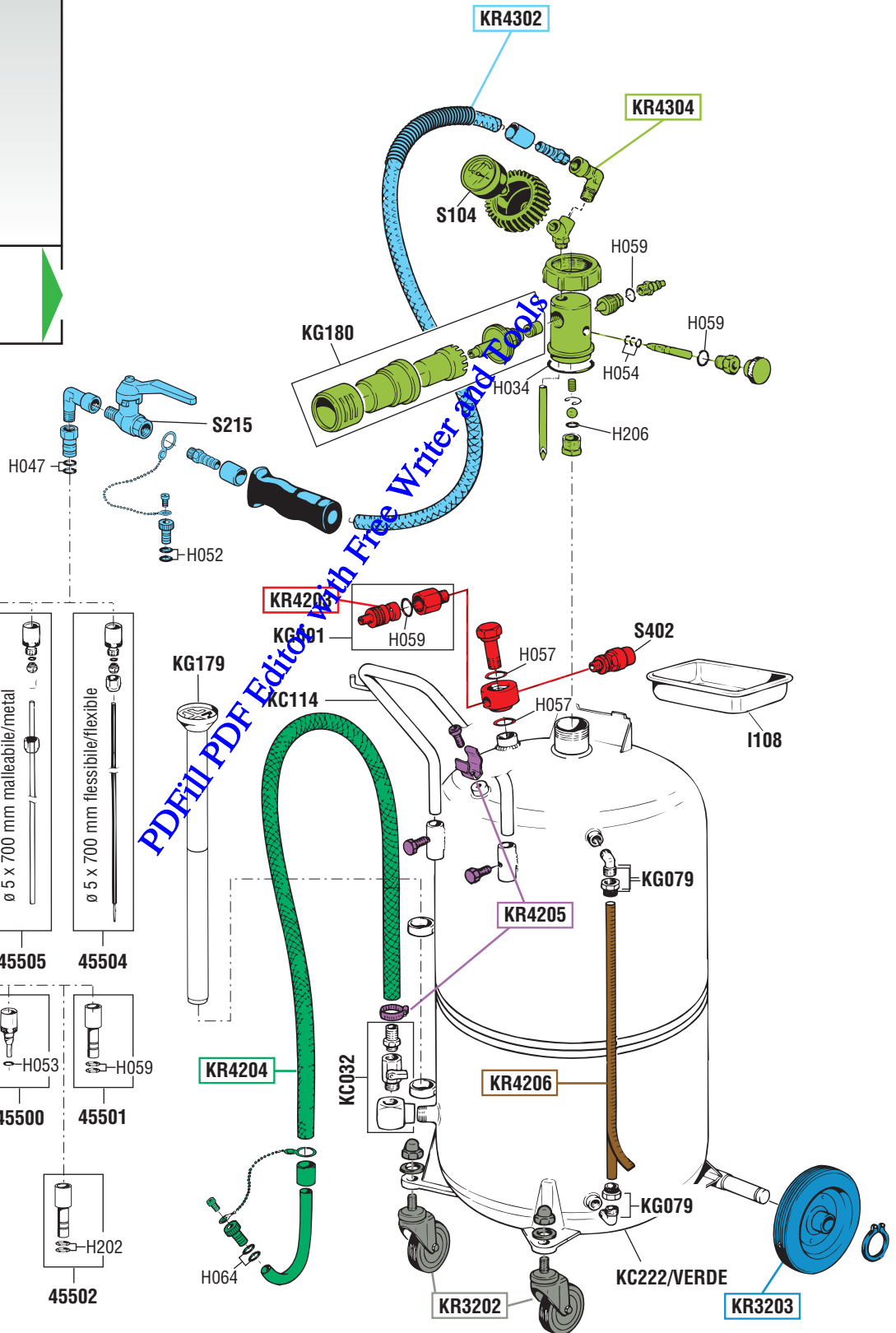

PDFFill PDF Editor With Free Writer and Tools

tutti i diritti riservati - all rights reserved



GUIDA RICAMBI - SPARE PARTS GUIDE

KIT RICAMBI OGNI KIT SOTTO RIPORTATO COMPRENDE I RICAMBI EVIDENZIATI CON LO STESSO COLORE E LE RELATIVE GUARNIZIONI. QUESTI RICAMBI NON SONO FORNIBILI SEPARATAMENTE TRANNE QUELLI CODIFICATI.		
SPARE PARTS KITS EACH KIT SHOWN WITH THE SAME COLOR INCLUDES ALSO THE GASKETS. THE SPARE PARTS INCLUDED IN THE KIT CAN'T BE SUPPLIED SEPARATELY EXCEPT THOSE SHOWN WITH A PROPER CODE.		
CODICE CODE	DESCRIZIONE DESCRIPTION	Q. TÀ QTY
KR3202	DUE RUOTE PIROETTANTI CON DADI TWO SWIVELLING WHEELS WITH NUTS	1
KR3203	2 RUOTE FISSE CON ANELLI ELASTICI 2 FIXED WHEELS WITH RETAINING RINGS	1
KR4203	GRUPPO RUBINETTO-VALVOLA DI SICUREZZA AIR TAP AND SAFETY VALVE GROUP	1
KR4204	TUBO SCARICO CON FASCETTA STRINGI TUBO DISCHARGING HOSE WITH HOSE CLAMP	1
KR4205	SET DI VITI PER SERBATOIO SET OF SCREWS FOR RESERVOIR	1
KR4206	TUBO LIVELLO CON ETICHETTA GAUGE TUBE WITH LABEL	1
KR4302	TUBO ASPIRAZIONE COMPLETO COMPLETE SUCTION HOSE	1
KR4304	GRUPPO ASPIRAZIONE CON RUBINETTO SUCTION GROUP WITH TAP	1

ELENCO RICAMBI FORNIBILI SINGOLARMENTE LIST OF SPARE PARTS WHICH CAN BE SUPPLIED SEPARATELY		
CODICE CODE	DESCRIZIONE DESCRIPTION	Q. TÀ QTY
45500	RACCORDO PER SONDE (VOLKSWAGEN) CONNECTOR FOR PROBES (VOLKSWAGEN)	1
45501	RACCORDO PER SONDE (BMW) CONNECTOR FOR PROBES (BMW)	1
45502	RACCORDO PER SONDE (CITROEN) CONNECTOR FOR PROBES (CITROEN)	1
45504	SONDA ϕ 5 x 700 FLESSIBILE PROBE ϕ 5 x 700 FLEXIBLE	1
45505	SONDA ϕ 5 x 700 METALLO-MALLEABILE PROBE ϕ 5 x 700 MALLEABLE METAL	1
45506	SONDA ϕ 6 x 700 FLESSIBILE PROBE ϕ 6 x 700 FLEXIBLE	1
45516	SONDA ϕ 6 x 700 METALLO-MALLEABILE PROBE ϕ 6 x 700 MALLEABLE METAL	1
45517	SONDA ϕ 7 x 1000 FLESSIBILE PROBE ϕ 7 x 1000 FLEXIBLE	1
45518	SONDA ϕ 8 x 700 FLESSIBILE PROBE ϕ 8 x 700 FLEXIBLE	1
I108	VASCHETTA PORTA OGGETTI TOOL TRAY	1
KC032	GRUPPO SCARICO SERBATOIO DISCHARGING GROUP	1
KC114	MANICO A "U" HANDLE	1
KC222/VERDE	SERBATOIO 90 l RESERVOIR 90 l	1
KG001	RUBINETTO UNIVERSALE CARICA ARIA UNIVERSAL AIR TAP	1
KG079	GRUPPO GOMITO E GHIERA RING AND ELBOW JOINT GROUP	2
KG179	GRUPPO PORTA SONDE PROBES CONTAINER	1
KG180	SILENZIATORE COMPLETO COMPLETE MUFFLER	1
S104	VUOTOMETRO ϕ 60 mm VACUUM GAUGE ϕ 60 mm	1
S215	RUBINETTO A SFERA 1/4" BALL VALVE 1/4"	1
S402	VALVOLA DI SICUREZZA 1 bar SAFETY VALVE 1 bar	1

Art. KR4351 KIT GUARNIZIONI COMPLETO COMPOSTO DALLE GUARNIZIONI SOTTO ELENcate JOINTS GASKETS LIST INCLUDING ALL THE GASKETS SHOWN HERE UNDER		
CODICE CODE	DESCRIZIONE DESCRIPTION	Q. TÀ QTY
H034	O-RING 3156 O-RING 3156	1
H047	O-RING 2050 O-RING 2050	2
H052	O-RING 106 O-RING 106	2
H053	O-RING 2025 O-RING 2025	1
H054	O-RING 2018 O-RING 2018	3
H057	O-RING 2062 O-RING 2062	2
H059	O-RING 2037 O-RING 2037	6
H064	O-RING 3043 O-RING 3043	2
H202	O-RING 2043 O-RING 2043	2
H206	O-RING 3043 "VITON" O-RING 3043 "VITON"	1

Art. KS4381 SET RICAMBI CONSIGLIATI AI PUNTI VENDITA E ASSISTENZA, COMPOSTO DAI RICAMBI SOTTO ELENcati SPARE PARTS KIT ADVISED TO THE REPAIR CENTERS. THIS KIT INCLUDES ALL THE SPARE PARTS SHOWN HERE UNDER		
CODICE CODE	DESCRIZIONE DESCRIPTION	Q. TÀ QTY
KR4204	TUBO SCARICO CON FASCETTA STRINGI TUBO DISCHARGING HOSE WITH HOSE CLAMP	1
KR4302	TUBO ASPIRAZIONE COMPLETO COMPLETE SUCTION HOSE	1
KR4351	KIT GUARNIZIONI COMPLETO COMPLETE GASKETS KIT	1
S104	VUOTOMETRO ϕ 60 mm VACUUM GAUGE ϕ 60 mm	1



Art. 43091 Mod. AO.91L



VISTA ESPLOSA - EXPLODED VIEW



ASPIRATORE PNEUMATICO OLIO ESAUSTO DA 90 L CON PRECAMERA
AIR-OPERATED WASTE OIL DRAINER 90 L TANK WITH PRECHAMBER

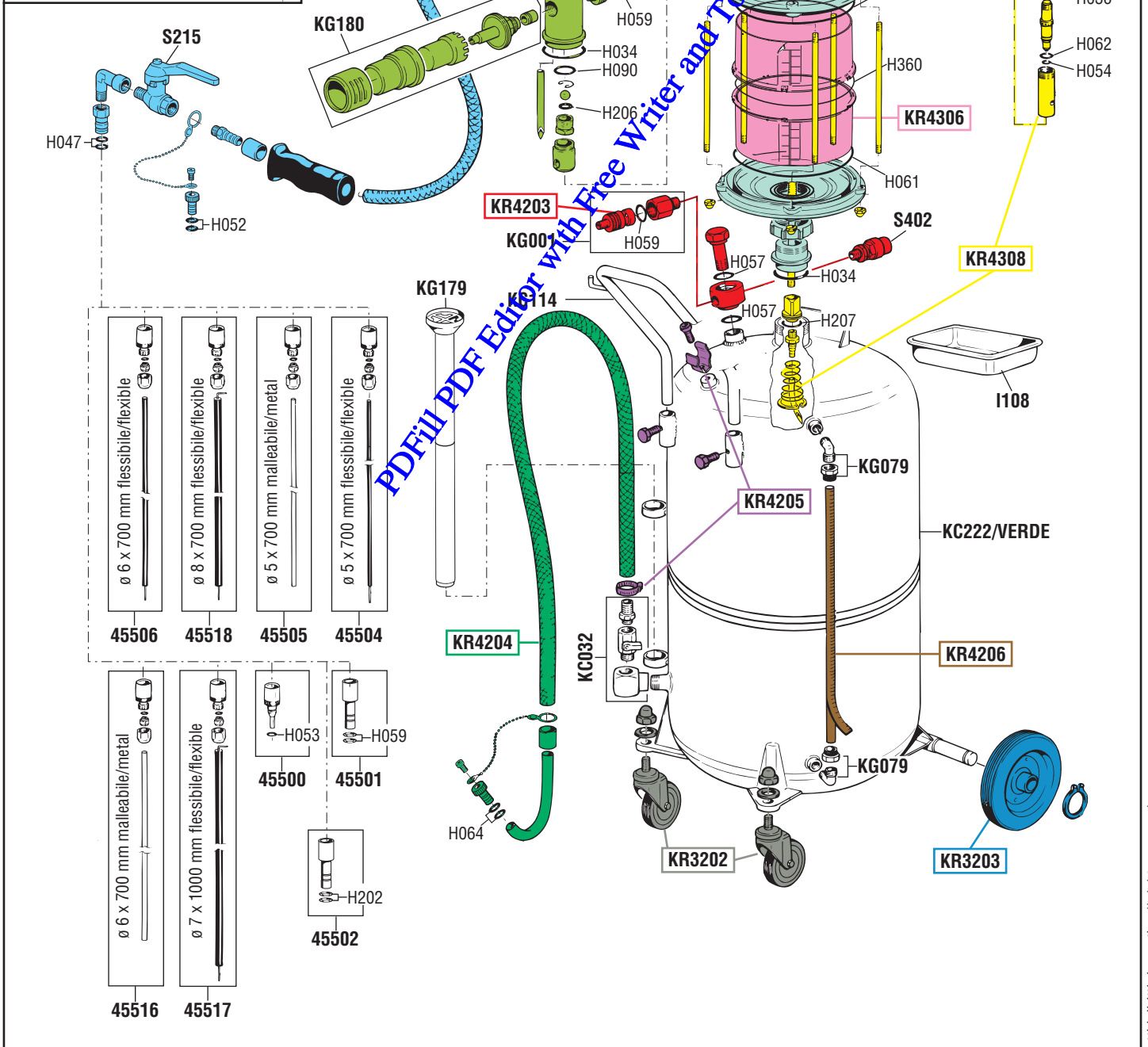

- 45506 ø 6 x 700 mm flessibile/flexible
- 45518 ø 8 x 700 mm flessibile/flexible
- 45505 ø 5 x 700 mm malleabile/metal
- 45504 ø 5 x 700 mm flessibile/flexible
- 45516 ø 6 x 700 mm malleabile/metal
- 45517 ø 7 x 1000 mm flessibile/flexible
- 45500 H053
- 45501 H059
- 45502 H202

PDFFill PDF Editor with Free Writer and Tools

tutti i diritti riservati - all rights reserved

GUIDA RICAMBI - SPARE PARTS GUIDE

KIT RICAMBI OGNI KIT SOTTO RIPORTATO COMPRENDE I RICAMBI EVIDENZIATI CON LO STESSO COLORE E LE RELATIVE GUARNIZIONI. QUESTI RICAMBI NON SONO FORNIBILI SEPARATAMENTE TRANNE QUELLI CODIFICATI.		
SPARE PARTS KITS EACH KIT SHOWN WITH THE SAME COLOR INCLUDES ALSO THE GASKETS. THE SPARE PARTS INCLUDED IN THE KIT CAN'T BE SUPPLIED SEPARATELY EXCEPT THOSE SHOWN WITH A PROPER CODE.		
CODICE CODE	DESCRIZIONE DESCRIPTION	Q.TÀ QTY
KR3202	DUE RUOTE PIROETTANTI CON DADI TWO SWIVELLING WHEELS WITH NUTS	1
KR3203	2 RUOTE FISSI CON ANELLI ELASTICI 2 FIXED WHEELS WITH RETAINING RINGS	1
KR4203	GRUPPO RUBINETTO-VALVOLA DI SICUREZZA AIR TAP AND SAFETY VALVE GROUP	1
KR4204	TUBO SCARICO CON FASCETTA STRINGI TUBO DISCHARGING HOSE WITH HOSE CLAMP	1
KR4205	SET DI VITI PER SERBATOIO SET OF SCREWS FOR RESERVOIR	1
KR4206	TUBO LIVELLO CON ETICHETTA GAUGE TUBE WITH LABEL	1
KR4302	TUBO ASPIRAZIONE COMPLETO COMPLETE SUCTION HOSE	1
KR4305	GRUPPO ASPIRAZIONE COMPLETO COMPLETE SUCTION GROUP	1
KR4306	CILINDRO - 2 O-RING - ETICHETTA CYLINDER - 2 O-RING - LABEL	1
KR4307	DUE FLANGE PRECAMERA TWO TRANSPARENT BOWL FLANGES	1
KR4308	ACCESSORI PRECAMERA TRANSPARENT BOWL ACCESSORIES	1

ELENCO RICAMBI FORNIBILI SINGOLARMENTE LIST OF SPARE PARTS WHICH CAN BE SUPPLIED SEPARATELY		
CODICE CODE	DESCRIZIONE DESCRIPTION	Q.TÀ QTY
45500	RACCORDO PER SONDE (VOLKSWAGEN) CONNECTOR FOR PROBES (VOLKSWAGEN)	1
45501	RACCORDO PER SONDE (BMW) CONNECTOR FOR PROBES (BMW)	1
45502	RACCORDO PER SONDE (CITROEN) CONNECTOR FOR PROBES (CITROEN)	1
45504	SONDA ø 5 x 700 FLESSIBILE PROBE ø 5 x 700 FLEXIBLE	1
45505	SONDA ø 5 x 700 METALLO-MALLEABILE PROBE ø 5 x 700 MALLEABLE METAL	1
45506	SONDA ø 6 x 700 FLESSIBILE PROBE ø 6 x 700 FLEXIBLE	1
45516	SONDA ø 6 x 700 METALLO-MALLEABILE PROBE ø 6 x 700 MALLEABLE METAL	1
45517	SONDA ø 7 x 1000 FLESSIBILE PROBE ø 7 x 1000 FLEXIBLE	1
45518	SONDA ø 8 x 700 FLESSIBILE PROBE ø 8 x 700 FLEXIBLE	1
I108	VASCHETTA PORTA OGGETTI TOOL TRAY	1
KC032	GRUPPO SCARICO SERBATOIO DISCHARGING GROUP	1
KC114	MANICO A "U" HANDLE	1
KC222/VERDE	SERBATOIO 90 l RESERVOIR 90 l	1
KG001	RUBINETTO UNIVERSALE CARICA ARIA UNIVERSAL AIR TAP	1
KG079	GRUPPO GOMITO E GHIERA RING AND ELBOW JOINT GROUP	2
KG179	CONTENITORE PORTA SONDE PROBES CONTAINER	1
KG180	SILENZIATORE COMPLETO COMPLETE MUFFLER	1
N513	LEVA BLOCCA PULSANTE PRECAMERA PRECHAMBER HOOKING LEVER	1
S104	VUOTOMETRO ø 60 mm VACUUM GAUGE ø 60 mm	1
S215	RUBINETTO A SFERA BALL VALVE 1/4"	1
S402	VALVOLA DI SICUREZZA 1 bar SAFETY VALVE 1 bar	1

Art. KR4352 KIT GUARNIZIONI COMPLETO COMPOSTO DALLE GUARNIZIONI SOTTO ELENCAE JOINTS GASKETS LIST INCLUDING ALL THE GASKETS SHOWN HERE UNDER		
CODICE CODE	DESCRIZIONE DESCRIPTION	Q.TÀ QTY
H034	O-RING 3156 O-RING 3156	2
H036	O-RING 3093 O-RING 3093	1
H047	O-RING 2050 O-RING 2050	2
H052	O-RING 106 O-RING 106	2
H053	O-RING 2025 O-RING 2025	1
H054	O-RING 2018 O-RING 2018	1
H057	O-RING 2062 O-RING 2062	2
H059	O-RING 2037 O-RING 2037	5
H061	O-RING 4750 O-RING 4750	2
H062	O-RING 109 "NBR 70" O-RING 109 "NBR 70"	1
H063	O-RING 4081 O-RING 4081	1
H064	O-RING 3043 O-RING 3043	2
H090	O-RING 3056 O-RING 3056	1
H202	O-RING 2043 O-RING 2043	2
H206	O-RING 3043 "VITON" O-RING 3043 "VITON"	1
H207	O-RING 4093 "VITON" O-RING 4093 "VITON"	1
H360	O-RING 3775 "NBR 70" O-RING 3775 "NBR 70"	1

Art. KS4382 SET RICAMBI CONSIGLIATI AI PUNTI VENDITA E ASSISTENZA. COMPOSTO DAI RICAMBI SOTTO ELENCAE SPARE PARTS KIT ADVISED TO THE REPAIR CENTERS. THIS KIT INCLUDES ALL THE SPARE PARTS SHOWN HERE UNDER		
CODICE CODE	DESCRIZIONE DESCRIPTION	Q.TÀ QTY
KR4204	TUBO SCARICO CON FASCETTA STRINGI TUBO DISCHARGING HOSE WITH HOSE CLAMP	1
KR4302	TUBO ASPIRAZIONE COMPLETO COMPLETE SUCTION HOSE	1
KR4306	CILINDRO - 2 O-RING - ETICHETTA CYLINDER - 2 O-RING - LABEL	1
KR4352	KIT GUARNIZIONI COMPLETO COMPLETE GASKETS KIT	1
S104	VUOTOMETRO ø 60 mm VACUUM GAUGE ø 60 mm	1



Art. 43114 Mod. A0.115L



VISTA ESPLOSA - EXPLODED VIEW

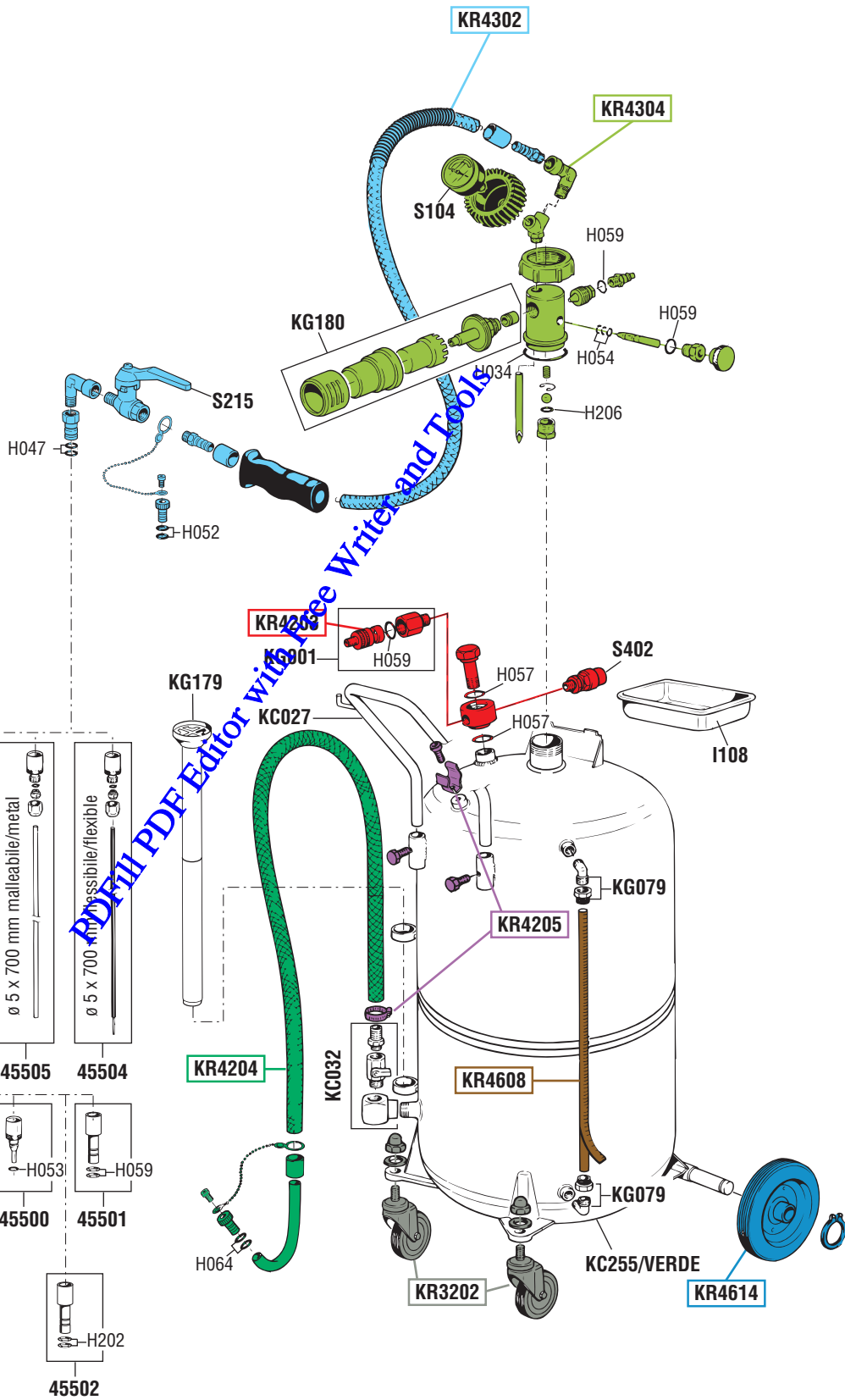

- | | | | |
|--|--|--|--|
| | | | |
| | | | |
| | | | |

PDF Fill Editor with Free Writer and Tools

tutti i diritti riservati - all rights reserved

GUIDA RICAMBI - SPARE PARTS GUIDE

KIT RICAMBI OGNI KIT SOTTO RIPORTATO COMPRENDE I RICAMBI EVIDENZIATI CON LO STESSO COLORE E LE RELATIVE GUARNIZIONI. QUESTI RICAMBI NON SONO FORNIBILI SEPARATAMENTE TRANNE QUELLI CODIFICATI.		
SPARE PARTS KITS EACH KIT SHOWN WITH THE SAME COLOR INCLUDES ALSO THE GASKETS. THE SPARE PARTS INCLUDED IN THE KIT CAN'T BE SUPPLIED SEPARATELY EXCEPT THOSE SHOWN WITH A PROPER CODE.		
CODICE CODE	DESCRIZIONE DESCRIPTION	Q. TÀ QTY
KR3202	DUE RUOTE PIROETTANTI CON DADI TWO SWIVELLING WHEELS WITH NUTS	1
KR4203	GRUPPO RUBINETTO-VALVOLA DI SICUREZZA AIR TAP AND SAFETY VALVE GROUP	1
KR4204	TUBO SCARICO CON FASCETTA STRINGI TUBO DISCHARGING HOSE WITH HOSE CLAMP	1
KR4205	SET DI VITI PER SERBATOIO SET OF SCREWS FOR RESERVOIR	1
KR4302	TUBO ASPIRAZIONE COMPLETO COMPLETE SUCTION HOSE	1
KR4304	GRUPPO ASPIRAZIONE CON RUBINETTO SUCTION GROUP WITH TAP	1
KR4608	TUBO LIVELLO CON ETICHETTA GAUGE TUBE WITH LABEL	1
KR4614	2 RUOTE FISSE CON ANELLI ELASTICI 2 FIXED WHEELS WITH RETAINING RINGS	1

ELENCO RICAMBI FORNIBILI SINGOLARMENTE LIST OF SPARE PARTS WHICH CAN BE SUPPLIED SEPARATELY		
CODICE CODE	DESCRIZIONE DESCRIPTION	Q. TÀ QTY
45500	RACCORDO PER SONDE (VOLKSWAGEN) CONNECTOR FOR PROBES (VOLKSWAGEN)	1
45501	RACCORDO PER SONDE (BMW) CONNECTOR FOR PROBES (BMW)	1
45502	RACCORDO PER SONDE (CITROEN) CONNECTOR FOR PROBES (CITROEN)	1
45504	SONDA ø 5 x 700 FLESSIBILE PROBE ø 5 x 700 FLEXIBLE	1
45505	SONDA ø 5 x 700 METALLO-MALLEABILE PROBE ø 5 x 700 MALLEABLE METAL	1
45506	SONDA ø 6 x 700 FLESSIBILE PROBE ø 6 x 700 FLEXIBLE	1
45516	SONDA ø 6 x 700 METALLO-MALLEABILE PROBE ø 6 x 700 MALLEABLE METAL	1
45517	SONDA ø 7 x 1000 FLESSIBILE PROBE ø 7 x 1000 FLEXIBLE	1
45518	SONDA ø 8 x 700 FLESSIBILE PROBE ø 8 x 700 FLEXIBLE	1
I108	VASCHETTA PORTA OGGETTI TOOL TRAY	1
KC027	MANICO A "U" HANDLE	1
KC032	GRUPPO SCARICO SERBATOIO DISCHARGING GROUP	1
KC255/VERDE	SERBATOIO 115 l RESERVOIR 115 l	1
KG001	RUBINETTO UNIVERSALE CARICA ARIA UNIVERSAL AIR TAP	1
KG079	GRUPPO GOMITO E GHIERA RING AND ELBOW JOINT GROUP	2
KG179	CONTENITORE PORTA SONDE PROBES CONTAINER	1
KG180	SILENZIATORE COMPLETO COMPLETE MUFFLER	1
S104	VUOTOMETRO ø 60 mm VACUUM GAUGE ø 60 mm	1
S215	RUBINETTO A SFERA 1/4" BALL VALVE 1/4"	1
S402	VALVOLA DI SICUREZZA 1 bar SAFETY VALVE 1 bar	1

Art. KR4351 KIT GUARNIZIONI COMPLETO COMPOSTO DALLE GUARNIZIONI SOTTO ELENcate JOINTS GASKETS LIST INCLUDING ALL THE GASKETS SHOWN HERE UNDER		
CODICE CODE	DESCRIZIONE DESCRIPTION	Q. TÀ QTY
H034	O-RING 3156 O-RING 3156	1
H047	O-RING 2050 O-RING 2050	2
H052	O-RING 106 O-RING 106	2
H053	O-RING 2025 O-RING 2025	1
H054	O-RING 2018 O-RING 2018	3
H057	O-RING 2062 O-RING 2062	2
H059	O-RING 2037 O-RING 2037	6
H064	O-RING 3043 O-RING 3043	2
H202	O-RING 2043 O-RING 2043	2
H206	O-RING 3043 "VITON" O-RING 3043 "VITON"	1

Art. KS4381 SET RICAMBI CONSIGLIATI AI PUNTI VENDITA E ASSISTENZA, COMPOSTO DAI RICAMBI SOTTO ELENcati SPARE PARTS KIT ADVISED TO THE REPAIR CENTERS. THIS KIT INCLUDES ALL THE SPARE PARTS SHOWN HERE UNDER		
CODICE CODE	DESCRIZIONE DESCRIPTION	Q. TÀ QTY
KR4204	TUBO SCARICO CON FASCETTA STRINGI TUBO DISCHARGING HOSE WITH HOSE CLAMP	1
KR4302	TUBO ASPIRAZIONE COMPLETO COMPLETE SUCTION HOSE	1
KR4351	KIT GUARNIZIONI COMPLETO COMPLETE GASKETS KIT	1
S104	VUOTOMETRO ø 60 mm VACUUM GAUGE ø 60 mm	1

GUIDA RICAMBI - SPARE PARTS GUIDE

KIT RICAMBI OGNI KIT SOTTO RIPORTATO COMPRENDE I RICAMBI EVIDENZIATI CON LO STESSO COLORE E LE RELATIVE GUARNIZIONI. QUESTI RICAMBI NON SONO FORNIBILI SEPARATAMENTE TRANNE QUELLI CODIFICATI.		
SPARE PARTS KITS EACH KIT SHOWN WITH THE SAME COLOR INCLUDES ALSO THE GASKETS. THE SPARE PARTS INCLUDED IN THE KIT CAN'T BE SUPPLIED SEPARATELY EXCEPT THOSE SHOWN WITH A PROPER CODE.		
CODICE CODE	DESCRIZIONE DESCRIPTION	Q. TÀ QTY
KR3202	DUE RUOTE PIROETTANTI CON DADI TWO SWIVELLING WHEELS WITH NUTS	1
KR4203	GRUPPO RUBINETTO-VALVOLA DI SICUREZZA AIR TAP AND SAFETY VALVE GROUP	1
KR4204	TUBO SCARICO CON FASCETTA STRINGI TUBO DISCHARGING HOSE WITH HOSE CLAMP	1
KR4205	SET DI VITI PER SERBATOIO SET OF SCREWS FOR RESERVOIR	1
KR4302	TUBO ASPIRAZIONE COMPLETO COMPLETE SUCTION HOSE	1
KR4305	GRUPPO ASPIRAZIONE COMPLETO COMPLETE SUCTION GROUP	1
KR4306	CILINDRO - 2 O-RING - ETICHETTA CYLINDER - 2 O-RING - LABEL	1
KR4307	DUE FLANGE PRECAMERA TWO TRANSPARENT BOWL FLANGES	1
KR4308	ACCESSORI PRECAMERA TRANSPARENT BOWL ACCESSORIES	1
KR4608	TUBO LIVELLO CON ETICHETTA GAUGE TUBE WITH LABEL	1
KR4614	2 RUOTE FISSE CON ANELLI ELASTICI 2 FIXED WHEELS WITH RETAINING RINGS	1

ELENCO RICAMBI FORNIBILI SINGOLARMENTE LIST OF SPARE PARTS WHICH CAN BE SUPPLIED SEPARATELY		
CODICE CODE	DESCRIZIONE DESCRIPTION	Q. TÀ QTY
45500	RACCORDO PER SONDE (VOLKSWAGEN) CONNECTOR FOR PROBES (VOLKSWAGEN)	1
45501	RACCORDO PER SONDE (BMW) CONNECTOR FOR PROBES (BMW)	1
45502	RACCORDO PER SONDE (CITROEN) CONNECTOR FOR PROBES (CITROEN)	1
45504	SONDA ø 5 x 700 FLESSIBILE PROBE ø 5 x 700 FLEXIBLE	1
45505	SONDA ø 5 x 700 METALLO-MALLEABILE PROBE ø 5 x 700 MALLEABLE METAL	1
45506	SONDA ø 6 x 700 FLESSIBILE PROBE ø 6 x 700 FLEXIBLE	1
45516	SONDA ø 6 x 700 METALLO-MALLEABILE PROBE ø 6 x 700 MALLEABLE METAL	1
45517	SONDA ø 7 x 1000 FLESSIBILE PROBE ø 7 x 1000 FLEXIBLE	1
45518	SONDA ø 8 x 700 FLESSIBILE PROBE ø 8 x 700 FLEXIBLE	1
I108	VASCHETTA PORTA OGGETTI TOOL TRAY	1
KC027	MANICO A "U" HANDLE	1
KC032	GRUPPO SCARICO SERBATOIO DISCHARGING GROUP	1
KC255/VERDE	SERBATOIO 115 l RESERVOIR 115 l	1
KG001	RUBINETTO UNIVERSALE CARICA ARIA UNIVERSAL AIR TAP	1
KG079	GRUPPO GOMITO E GHIERA RING AND ELBOW JOINT GROUP	2
KG179	CONTENITORE PORTA SONDE PROBES CONTAINER	1
KG180	SILENZIATORE COMPLETO COMPLETE MUFFLER	1
N513	LEVA BLOCCA PULSANTE PRECAMERA PRECHAMBER HOOKING LEVER	1
S104	VUOTOMETRO ø 60 mm VACUUM GAUGE ø 60 mm	1
S215	RUBINETTO A SFERA BALL VALVE 1/4"	1
S402	VALVOLA DI SICUREZZA 1 bar SAFETY VALVE 1 bar	1

Art. KR4352 KIT GUARNIZIONI COMPLETO COMPOSTO DALLE GUARNIZIONI SOTTO ELENCAE JOINTS GASKETS LIST INCLUDING ALL THE GASKETS SHOWN HERE UNDER		
CODICE CODE	DESCRIZIONE DESCRIPTION	Q. TÀ QTY
H034	O-RING 3156 O-RING 3156	2
H036	O-RING 3093 O-RING 3093	1
H047	O-RING 2050 O-RING 2050	2
H052	O-RING 106 O-RING 106	2
H053	O-RING 2025 O-RING 2025	1
H054	O-RING 2018 O-RING 2018	1
H057	O-RING 2062 O-RING 2062	2
H059	O-RING 2037 O-RING 2037	5
H061	O-RING 4750 O-RING 4750	2
H062	O-RING 109 "NBR 70" O-RING 109 "NBR 70"	1
H063	O-RING 4081 O-RING 4081	1
H064	O-RING 3043 O-RING 3043	2
H090	O-RING 3056 O-RING 3056	1
H202	O-RING 2043 O-RING 2043	2
H206	O-RING 3043 "VITON" O-RING 3043 "VITON"	1
H207	O-RING 4093 "VITON" O-RING 4093 "VITON"	1
H360	O-RING 3775 "NBR 70" O-RING 3775 "NBR 70"	1

Art. KS4382 SET RICAMBI CONSIGLIATI AI PUNTI VENDITA E ASSISTENZA. COMPOSTO DAI RICAMBI SOTTO ELENCAE SPARE PARTS KIT ADVISED TO THE REPAIR CENTERS. THIS KIT INCLUDES ALL THE SPARE PARTS SHOWN HERE UNDER		
CODICE CODE	DESCRIZIONE DESCRIPTION	Q. TÀ QTY
KR4204	TUBO SCARICO CON FASCETTA STRINGI TUBO DISCHARGING HOSE WITH HOSE CLAMP	1
KR4302	TUBO ASPIRAZIONE COMPLETO COMPLETE SUCTION HOSE	1
KR4306	CILINDRO - 2 O-RING - ETICHETTA CYLINDER - 2 O-RING - LABEL	1
KR4352	KIT GUARNIZIONI COMPLETO COMPLETE GASKETS KIT	1
S104	VUOTOMETRO ø 60 mm VACUUM GAUGE ø 60 mm	1



Art. 43116 Mod. AO.16L



VISTA ESPLOSA - EXPLODED VIEW



ASPIRATORE PNEUMATICO DA 16 l
PORTABLE AIR-OPERATED WITH 16 l TANK

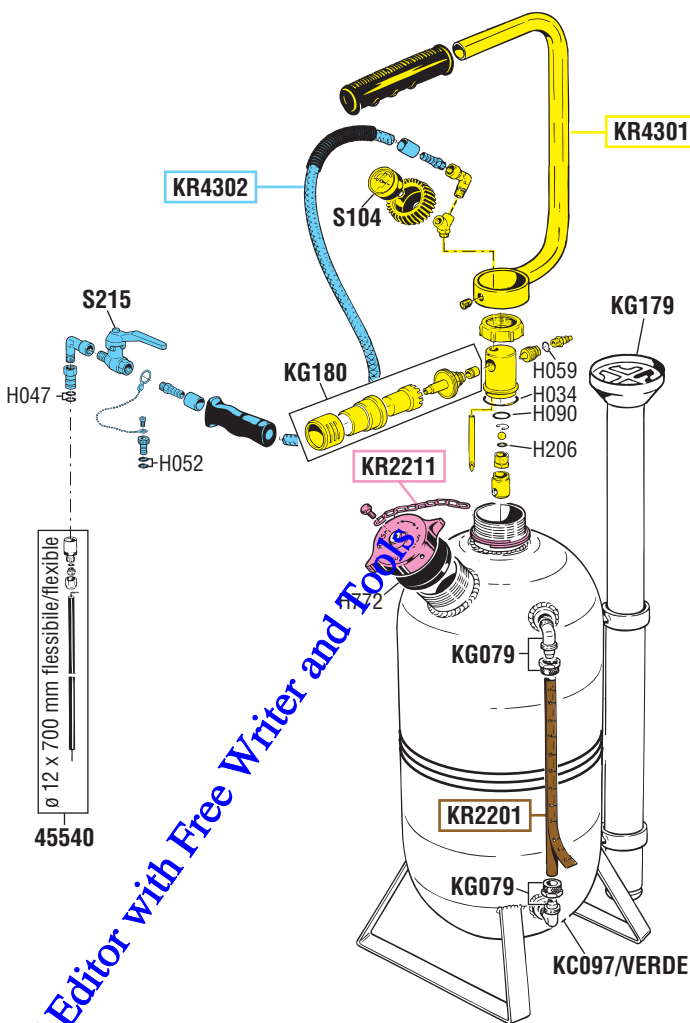

GUIDA RICAMBI - SPARE PARTS GUIDE

KIT RICAMBI
OGNI KIT SOTTO RIPORTATO COMPRENDE I RICAMBI EVIDENZIATI CON LO STESSO COLORE E LE RELATIVE GUARNIZIONI. QUESTI RICAMBI NON SONO FORNIBILI SEPARATAMENTE TRANNE QUELLI CODIFICATI.

SPARE PARTS KITS
EACH KIT SHOWN WITH THE SAME COLOR INCLUDES ALSO THE GASKETS. THE SPARE PARTS INCLUDED IN THE KIT CAN'T BE SUPPLIED SEPARATELY EXCEPT THOSE SHOWN WITH A PROPER CODE.

CODICE CODE	DESCRIZIONE DESCRIPTION	Q.TÀ QTY
KR2201	TUBO DI LIVELLO ED ETICHETTA GAUGE TUBE AND LABEL	1
KR2211	TAPPO ALTA PRESSIONE HIGH PRESSURE PLUG	1
KR4301	GRUPPO ASPIRATORE E MANICO SUCTION GROUP AND HANDLE	1
KR4302	TUBO ASPIRAZIONE COMPLETO COMPLETE SUCTION HOSE	1

ELENCO RICAMBI FORNIBILI SINGOLARMENTE
LIST OF SPARE PARTS WHICH CAN BE SUPPLIED SEPARATELY

CODICE CODE	DESCRIZIONE DESCRIPTION	Q.TÀ QTY
45540	SONDA ø 12 x 700 FLESSIBILE PROBE ø 12 x 700 FLEXIBLE	1
KC097/VERDE	SERBATOIO 16 l RESERVOIR 16 l	1
KG079	GRUPPO GOMITO E GHIERA RING AND ELBOW JOINT GROUP	2
KG180	SILENZIATORE COMPLETO COMPLETE MUFFLER	1
S104	VUOTOMETRO ø 60 mm VACUUM GAUGE ø 60 mm	1
S215	RUBINETTO A SFERA 1/4" BALL VALVE 1/4"	1

Art. KR4350 KIT GUARNIZIONI COMPLETO
COMPOSTO DALLE GUARNIZIONI SOTTO ELENCATE JOINTS GASKETS LIST INCLUDING ALL THE GASKETS SHOWN HERE UNDER

CODICE CODE	DESCRIZIONE DESCRIPTION	Q.TÀ QTY
H034	O-RING 3156 O-RING 3156	1
H047	O-RING 2050 O-RING 2050	1
H052	O-RING 106 O-RING 106	1
H059	O-RING 2037 O-RING 2037	1
H090	O-RING 3056 O-RING 3056	2
H206	O-RING 3043 "VITON" O-RING 3043 "VITON"	1
H772	GUARNIZIONE TAPPO GASKET	1

Art. KS4380 SET RICAMBI CONSIGLIATI
AI PUNTI VENDITA E ASSISTENZA, COMPOSTO DAI RICAMBI SOTTO ELENCATI
SPARE PARTS KIT ADVISED
TO THE REPAIR CENTERS. THIS KIT INCLUDES ALL THE SPARE PARTS SHOWN HERE UNDER

CODICE CODE	DESCRIZIONE DESCRIPTION	Q.TÀ QTY
KR4302	TUBO ASPIRAZIONE COMPLETO COMPLETE SUCTION HOSE	1
KR4350	KIT GUARNIZIONI COMPLETO COMPLETE GASKETS KIT	1
S104	VUOTOMETRO ø 60 mm VACUUM GAUGE ø 60 mm	1

tutti i diritti riservati - all rights reserved



tecnologia qualità & funzionalità
 technology, quality, functionality

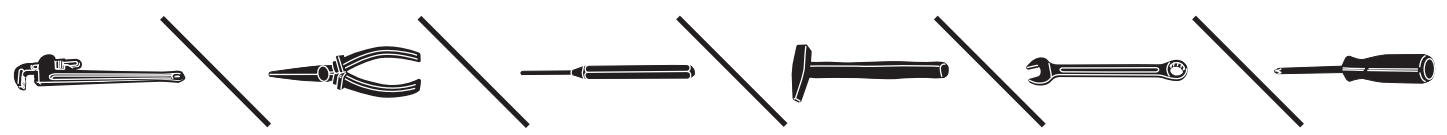



Art. 43190 Mod. AOI.90L



VISTA ESPLOSA - EXPLODED VIEW



ASPIRATORE PNEUMATICO
CON PRECAMERA DA 90 l
AIR-OPERATED OIL DRAINER 90 l
TANK WITH PRECHAMBER

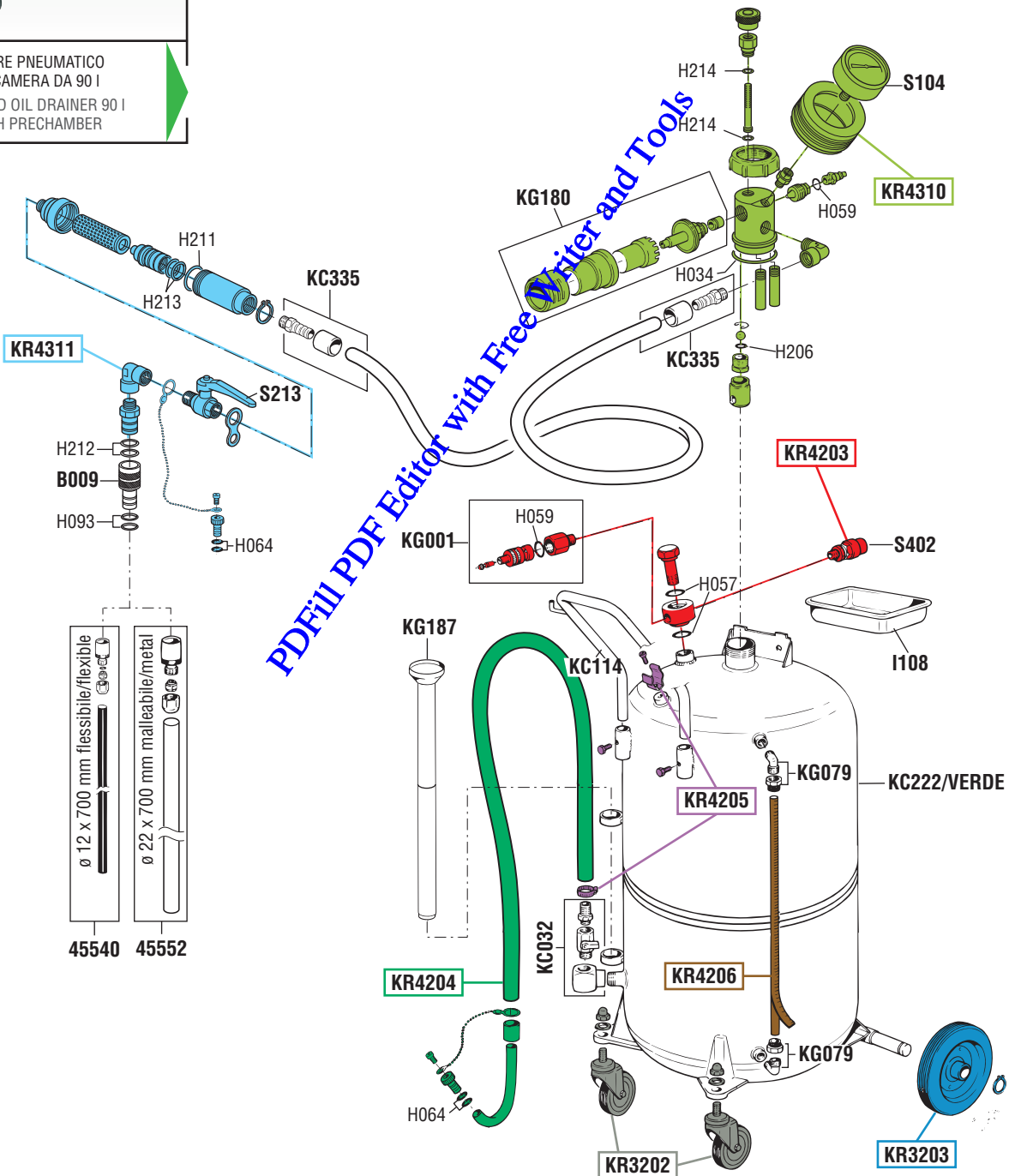

PDFFill PDF Editor with Free Water and Tools

tutti i diritti riservati - all rights reserved

GUIDA RICAMBI - SPARE PARTS GUIDE

KIT RICAMBI OGNI KIT SOTTO RIPORTATO COMPRENDE I RICAMBI EVIDENZIATI CON LO STESSO COLORE E LE RELATIVE GUARNIZIONI. QUESTI RICAMBI NON SONO FORNIBILI SEPARATAMENTE TRANNE QUELLI CODIFICATI.		
SPARE PARTS KITS EACH KIT SHOWN WITH THE SAME COLOR INCLUDES ALSO THE GASKETS. THE SPARE PARTS INCLUDED IN THE KIT CAN'T BE SUPPLIED SEPARATELY EXCEPT THOSE SHOWN WITH A PROPER CODE.		
CODICE CODE	DESCRIZIONE DESCRIPTION	Q.TÀ QTY
KR3202	DUE RUOTE PIROETTANTI CON DADI TWO SWIVELLING WHEELS WITH NUTS	1
KR3203	2 RUOTE FISSE CON ANELLI ELASTICI 2 FIXED WHEELS WITH RETAINING RINGS	1
KR4203	GRUPPO RUBINETTO-VALVOLA DI SICUREZZA AIR TAP AND SAFETY VALVE GROUP	1
KR4204	TUBO SCARICO CON FASCETTA STRINGI TUBO DISCHARGING HOSE WITH HOSE CLAMP	1
KR4205	SET DI VITI PER SERBATOIO SET OF SCREWS FOR RESERVOIR	1
KR4206	TUBO LIVELLO CON ETICHETTA GAUGE TUBE WITH LABEL	1
KR4310	GRUPPO ASPIRAZIONE SUCTION GROUP	1
KR4311	GRUPPO CON FILTRO GROUP WITH FILTER	1

ELENCO RICAMBI FORNIBILI SINGOLARMENTE LIST OF SPARE PARTS WHICH CAN BE SUPPLIED SEPARATELY		
CODICE CODE	DESCRIZIONE DESCRIPTION	Q.TÀ QTY
45540	SONDA ø 12 x 700 FLESSIBILE PROBE ø 12 x 700 FLEXIBLE	1
45552	SONDA ø 22 x 700 METALLO-MALLEABILE PROBE ø 22 x 700 MALLEABLE METAL	1
B009	ADATTATORE PER SONDA PROBE ADAPTOR	1
I108	VASCHELLA PORTA OGGETTI TOOL TRAY	1
KC032	GRUPPO SCARICO SERBATOIO DISCHARGING GROUP	1
KC114	MANICO A "U" HANDLE	1
KC222/VERDE	SERBATOIO 90 l RESERVOIR 90 l	1
KC335	TUBO ASPIRAZIONE COMPLETO COMPLETE SUCTION HOSE	1
KG001	RUBINETTO UNIVERSALE CARICA ARIA UNIVERSAL AIR TAP	1
KG079	GRUPPO GOMITO E GHIERA RING AND ELBOW JOINT GROUP	2
KG180	SILENZIATORE COMPLETO COMPLETE MUFFLER	1
KG187	CONTENITORE PORTA SONDE PROBES CONTAINER	1
S104	VUOTOMETRO ø 60 mm VACUUM GAUGE ø 60 mm	1
S213	RUBINETTO A SFERA 1/2" BALL VALVE 1/2"	1
S402	VALVOLA DI SICUREZZA 1 bar SAFETY VALVE 1 bar	1

Art. KR4353 KIT GUARNIZIONI COMPLETO COMPOSTO DALLE GUARNIZIONI SOTTO ELENcate JOINTS GASKETS LIST INCLUDING ALL THE GASKETS SHOWN HERE UNDER		
CODICE CODE	DESCRIZIONE DESCRIPTION	Q.TÀ QTY
H034	O-RING 3156 O-RING 3156	1
H057	O-RING 2062 O-RING 2062	2
H059	O-RING 2037 O-RING 2037	2
H064	O-RING 3043 O-RING 3043	4
H093	O-RING 2050 "VITON" O-RING 2050 "VITON"	2
H206	O-RING 3043 "VITON" O-RING 3043 "VITON"	1
H211	O-RING 2037 "VITON" O-RING 2037 "VITON"	1
H212	O-RING 2075 "VITON" O-RING 2075 "VITON"	2
H213	O-RING 2087 "VITON" O-RING 2087 "VITON"	2
H214	O-RING 2025 "VITON" O-RING 2025 "VITON"	2

Art. KS4383 SET RICAMBI CONSIGLIATI AI PUNTI VENDITA E ASSISTENZA. COMPOSTO DAI RICAMBI SOTTO ELENcATI SPARE PARTS KIT ADVISED TO THE REPAIR CENTERS. THIS KIT INCLUDES ALL THE SPARE PARTS SHOWN HERE UNDER		
CODICE CODE	DESCRIZIONE DESCRIPTION	Q.TÀ QTY
KC335	TUBO ASPIRAZIONE COMPLETO COMPLETE SUCTION HOSE	1
KR4204	TUBO SCARICO CON FASCETTA STRINGI TUBO DISCHARGING HOSE WITH HOSE CLAMP	1
KR4353	KIT GUARNIZIONI COMPLETO COMPLETE GASKETS KIT	1
S104	VUOTOMETRO ø 60 mm VACUUM GAUGE ø 60 mm	1

PDFfill PDF Editor with Free Writer and Tools



Art. 43724 Mod. AO.24L



VISTA ESPLOSA - EXPLODED VIEW

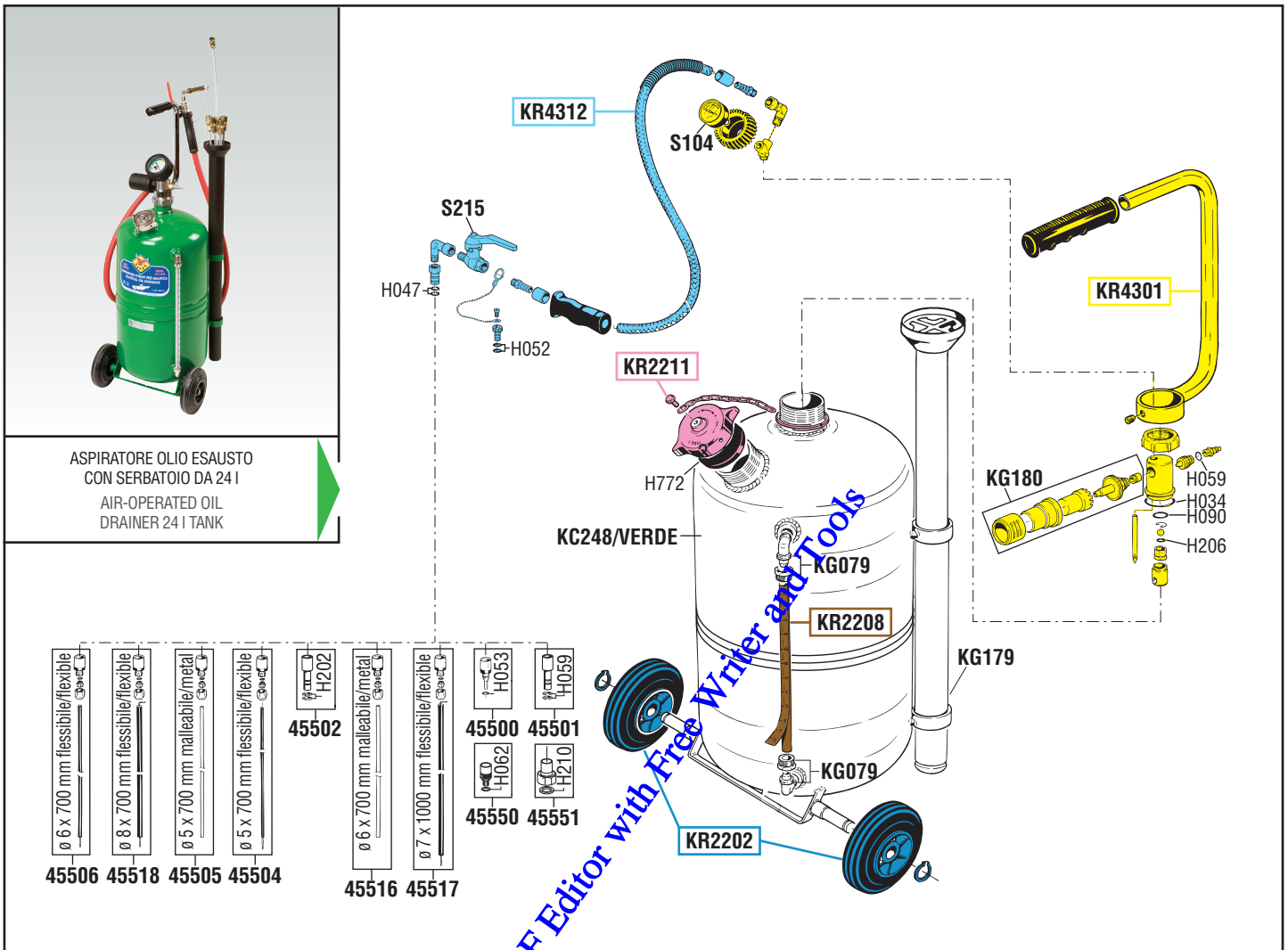

ASPIRATORE OLIO ESAUSTO CON SERBATOIO DA 24 L
AIR-OPERATED OIL DRAINER 24 L TANK

- 45506 ø 6 x 700 mm flessibile/flexible
- 45518 ø 8 x 700 mm flessibile/flexible
- 45505 ø 5 x 700 mm malleabile/metal
- 45504 ø 5 x 700 mm flessibile/flexible
- 45516 H202 ø 6 x 700 mm malleabile/metal
- 45517 ø 7 x 1000 mm flessibile/flexible
- 45550 H053 ø 5 x 700 mm malleabile/metal
- 45551 H059 ø 5 x 700 mm malleabile/metal

GUIDA RICAMBI - SPARE PARTS GUIDE

KIT RICAMBI
OGNI KIT SOTTO RIPORTATO COMPRENDE I RICAMBI EVIDENZIATI CON LO STESSO COLORE E LE RELATIVE GUARNIZIONI. QUESTI RICAMBI NON SONO FORNIBILI SEPARATAMENTE TRANNE QUELLI CODIFICATI.

SPARE PARTS KITS
EACH KIT SHOWN WITH THE SAME COLOR INCLUDES ALSO THE GASKETS. THE SPARE PARTS INCLUDED IN THE KIT CAN'T BE SUPPLIED SEPARATELY EXCEPT THOSE SHOWN WITH A PROPER CODE.

CODICE CODE	DESCRIZIONE DESCRIPTION	Q.TÀ QTY
KR2202	DUE RUOTE Fisse con anelli elastici / TWO FIXED WHEELS WITH RETAINING RINGS	1
KR2208	TUBO DI LIVELLO CON ETICHETTA / GAUGE TUBE WITH LABEL	1
KR2211	TAPPO ALTA PRESSIONE / HIGH PRESSURE PLUG	1
KR4301	GRUPPO ASPIRATORE E MANICO / SUCTION GROUP AND HANDLE	1
KR4312	TUBO ASPIRAZIONE COMPLETO / COMPLETE SUCTION HOSE	1

ELENCO RICAMBI FORNIBILI SINGOLARMENTE
LIST OF SPARE PARTS WHICH CAN BE SUPPLIED SEPARATELY

CODICE CODE	DESCRIZIONE DESCRIPTION	Q.TÀ QTY
45500	RACCORDO PER SONDE (VOLKSWAGEN) / CONNECTOR FOR PROBES (VOLKSWAGEN)	1
45501	RACCORDO PER SONDE (BMW) / CONNECTOR FOR PROBES (BMW)	1
45502	RACCORDO PER SONDE (CITROEN) / CONNECTOR FOR PROBES (CITROEN)	1
45504	SONDA ø 5 x 700 FLESSIBILE / PROBE ø 5 x 700 FLEXIBLE	1
45505	SONDA ø 5 x 700 METALLO-MALLEABILE / PROBE ø 5 x 700 MALLEABLE METAL	1
45506	SONDA ø 6 x 700 FLESSIBILE / PROBE ø 6 x 700 FLEXIBLE	1
45516	SONDA ø 6 x 700 METALLO-MALLEABILE / PROBE ø 6 x 700 MALLEABLE METAL	1
45517	SONDA ø 7 x 1000 FLESSIBILE / PROBE ø 7 x 1000 FLEXIBLE	1
45518	SONDA ø 8 x 700 FLESSIBILE / PROBE ø 8 x 700 FLEXIBLE	1
45550	RACCORDO M 3/8" - 16 UNC / CONNECTOR 3/8" - 16 UNC	1
45551	RACCORDO F 3/4" - NH / CONNECTOR F 3/4" - NH	1
KC248/VERDE	SERBATOIO 24 L / RESERVOIR 24 L	1
KG079	GRUPPO GOMITO E GHIERA / RING AND ELBOW JOINT GROUP	2
KG179	CONTENITORE PORTA SONDE / PROBES CONTAINER	1
KG180	SILENZIATORE COMPLETO / COMPLETE MUFFLER	1
S104	VUOTOMETRO ø 60 mm / VACUUM GAUGE ø 60 mm	1
S215	RUBINETTO A SFERA 1/4" / BALL VALVE 1/4"	1

Art. KR4350 KIT GUARNIZIONI COMPLETO
COMPOSTO DALLE GUARNIZIONI SOTTO ELENCAE / JOINTS GASKETS LIST INCLUDING ALL THE GASKETS SHOWN HERE UNDER

CODICE CODE	DESCRIZIONE DESCRIPTION	Q.TÀ QTY
H034	O-RING 3156	1
H047	O-RING 2050	2
H052	O-RING 106	2
H053	O-RING 2025	1
H059	O-RING 2037	3
H090	O-RING 3056	1
H202	O-RING 2043	2
H206	O-RING 3043 "VITON"	1
H772	GUARNIZIONE TAPPO / GASKET	1

Art. KS4384 SET RICAMBI CONSIGLIATI
AI PUNTI VENDITA E ASSISTENZA, COMPOSTO DAI RICAMBI SOTTO ELENCAE / SPARE PARTS KIT ADVISED TO THE REPAIR CENTERS. THIS KIT INCLUDES ALL THE SPARE PARTS SHOWN HERE UNDER

CODICE CODE	DESCRIZIONE DESCRIPTION	Q.TÀ QTY
KR4312	TUBO ASPIRAZIONE COMPLETO / COMPLETE SUCTION HOSE	1
KR4350	KIT GUARNIZIONI COMPLETO / COMPLETE GASKETS KIT	1
S104	VUOTOMETRO ø 60 mm / VACUUM GAUGE ø 60 mm	1

tutti i diritti riservati - all rights reserved



Art. 43760 Mod. AO.60L



VISTA ESPLOSA - EXPLODED VIEW

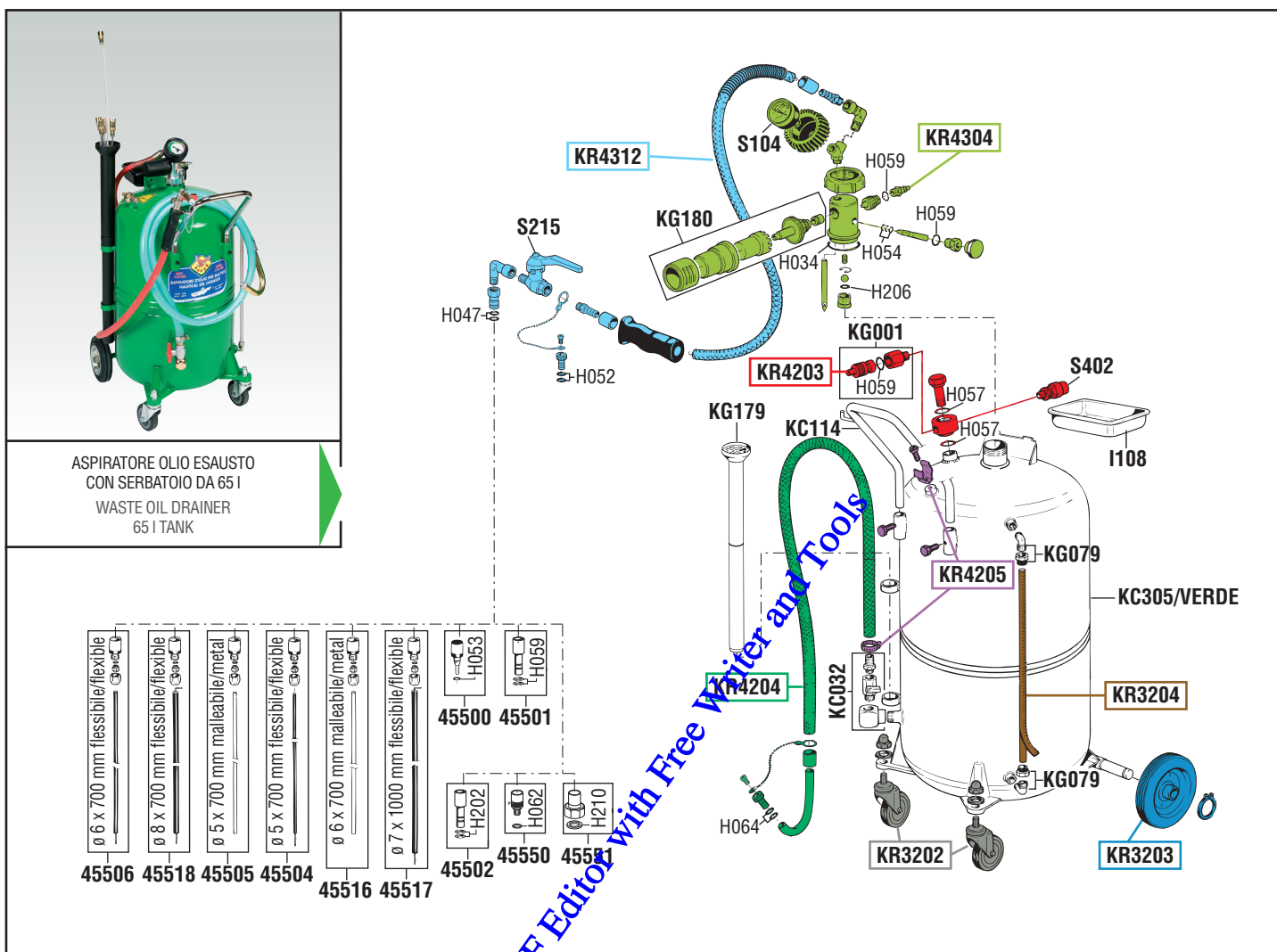

ASPIRATORE OLIO ESAUSTO CON SERBATOIO DA 65 l
WASTE OIL DRAINER
65 l TANK

- 45506 ø 6 x 700 mm flessibile/flexible
- 45518 ø 8 x 700 mm flessibile/flexible
- 45505 ø 5 x 700 mm malleabile/metal
- 45504 ø 5 x 700 mm flessibile/flexible
- 45516 ø 6 x 700 mm malleabile/metal
- 45517 ø 7 x 1000 mm flessibile/flexible
- 45502 H202
- 45550 H062
- 45551 H210
- 45500 H053
- 45501 H059

GUIDA RICAMBI - SPARE PARTS GUIDE

KIT RICAMBI
OGNI KIT SOTTO RIPORTATO COMPRENDE I RICAMBI EVIDENZIATI CON LO STESSO COLORE E LE RELATIVE GUARNIZIONI. QUESTI RICAMBI NON SONO FORNIBILI SEPARATAMENTE TRANNE QUELLI CODIFICATI.

SPARE PARTS KITS
EACH KIT SHOWN WITH THE SAME COLOR INCLUDES ALSO THE GASKETS. THE SPARE PARTS INCLUDED IN THE KIT CAN'T BE SUPPLIED SEPARATELY EXCEPT THOSE SHOWN WITH A PROPER CODE.

CODICE CODE	DESCRIZIONE DESCRIPTION	Q.TÀ QTY
KR3202	DUE RUOTE PIROETTANTI CON DADI TWO SWIVELLING WHEELS WITH NUTS	1
KR3203	2 RUOTE Fisse CON ANELLI ELASTICI 2 FIXED WHEELS WITH RETAINING RINGS	1
KR3204	TUBO DI LIVELLO ED ETICHETTA GAUGE TUBE AND LABEL	1
KR4203	GRUPPO RUBINETTO-VALVOLA DI SICUREZZA AIR TAP AND SAFETY VALVE GROUP	1
KR4204	TUBO SCARICO CON FASCETTA STRINGI TUBO DISCHARGING HOSE WITH HOSE CLAMP	1
KR4205	SET DI VITI PER SERBATOIO SET OF SCREWS FOR RESERVOIR	1
KR4304	GRUPPO ASPIRAZIONE CON RUBINETTO SUCTION GROUP WITH TAP	1
KR4312	TUBO ASPIRAZIONE COMPLETO COMPLETE SUCTION HOSE	1

ELENCO RICAMBI FORNIBILI SINGOLARMENTE
LIST OF SPARE PARTS WHICH CAN BE SUPPLIED SEPARATELY

CODICE CODE	DESCRIZIONE DESCRIPTION	Q.TÀ QTY
45500	RACCORDO PER SONDE (VOLKSWAGEN) CONNECTOR FOR PROBES (VOLKSWAGEN)	1
45501	RACCORDO PER SONDE (BMW) CONNECTOR FOR PROBES (BMW)	1
45502	RACCORDO PER SONDE (CITROEN) CONNECTOR FOR PROBES (CITROEN)	1
45504	SONDA ø 5 x 700 FLESSIBILE PROBE ø 5 x 700 FLEXIBLE	1
45505	SONDA ø 5 x 700 METALLO-MALLEABILE PROBE ø 5 x 700 MALLEABLE METAL	1
45506	SONDA ø 6 x 700 FLESSIBILE PROBE ø 6 x 700 FLEXIBLE	1
45516	SONDA ø 6 x 700 METALLO-MALLEABILE PROBE ø 6 x 700 MALLEABLE METAL	1
45517	SONDA ø 7 x 1000 FLESSIBILE PROBE ø 7 x 1000 FLEXIBLE	1
45518	SONDA ø 8 x 700 FLESSIBILE PROBE ø 8 x 700 FLEXIBLE	1
45550	RACCORDO M 3/8" - 16 UNC CONNECTOR 3/8" - 16 UNC	1
45551	RACCORDO F 3/4" - NH CONNECTOR F 3/4" - NH	1
I108	VASCHETTA PORTA OGGETTI TOOL TRAY	1
KC032	GRUPPO SCARICO SERBATOIO DISCHARGING GROUP	1
KC114	MANICO A "U" HANDLE	1
KC305/VERDE	SERBATOIO 65 l RESERVOIR 65 l	2
KG001	RUBINETTO UNIVERSALE CARICA ARIA UNIVERSAL AIR TAP	1
KG079	GRUPPO GOMITO E GHIERA RING AND ELBOW JOINT GROUP	1
KG179	CONTENITORE PORTA SONDE PROBES CONTAINER	1
KG180	SILENZIATORE COMPLETO COMPLETE MUFFLER	1
S104	VUOTOMETRO ø 60 mm VACUUM GAUGE ø 60 mm	1
S215	RUBINETTO A SFERA 1/4" BALL VALVE 1/4"	1
S402	VALVOLA DI SICUREZZA 1 bar SAFETY VALVE 1 bar	1

Art. KR4351
KIT GUARNIZIONI COMPLETO
COMPOSTO DALLE GUARNIZIONI SOTTO ELENCAE
JOINTS GASKETS LIST
INCLUDING ALL THE GASKETS SHOWN HERE UNDER

CODICE CODE	DESCRIZIONE DESCRIPTION	Q.TÀ QTY
H034	O-RING 3156	1
H047	O-RING 2050	2
H052	O-RING 106	2
H053	O-RING 2025	1
H054	O-RING 2018	3
H057	O-RING 2062	2
H059	O-RING 2037	6
H064	O-RING 3043	2
H202	O-RING 2043	2
H206	O-RING 3043 "VITON"	1

Art. KS4385
SET RICAMBI CONSIGLIATI
AI PUNTI VENDITA E ASSISTENZA.
COMPOSTO DAI RICAMBI SOTTO ELENCAE
SPARE PARTS KIT ADVISED
TO THE REPAIR CENTERS. THIS KIT INCLUDES
ALL THE SPARE PARTS SHOWN HERE UNDER

CODICE CODE	DESCRIZIONE DESCRIPTION	Q.TÀ QTY
KR4204	TUBO SCARICO CON FASCETTA STRINGI TUBO DISCHARGING HOSE WITH HOSE CLAMP	1
KR4312	TUBO ASPIRAZIONE COMPLETO COMPLETE SUCTION HOSE	1
KR4351	KIT GUARNIZIONI COMPLETO COMPLETE GASKETS KIT	1
S104	VUOTOMETRO ø 60 mm VACUUM GAUGE ø 60 mm	1

tutti i diritti riservati - all rights reserved



Art. 43765 Mod. AO.65L



VISTA ESPLOSA - EXPLODED VIEW

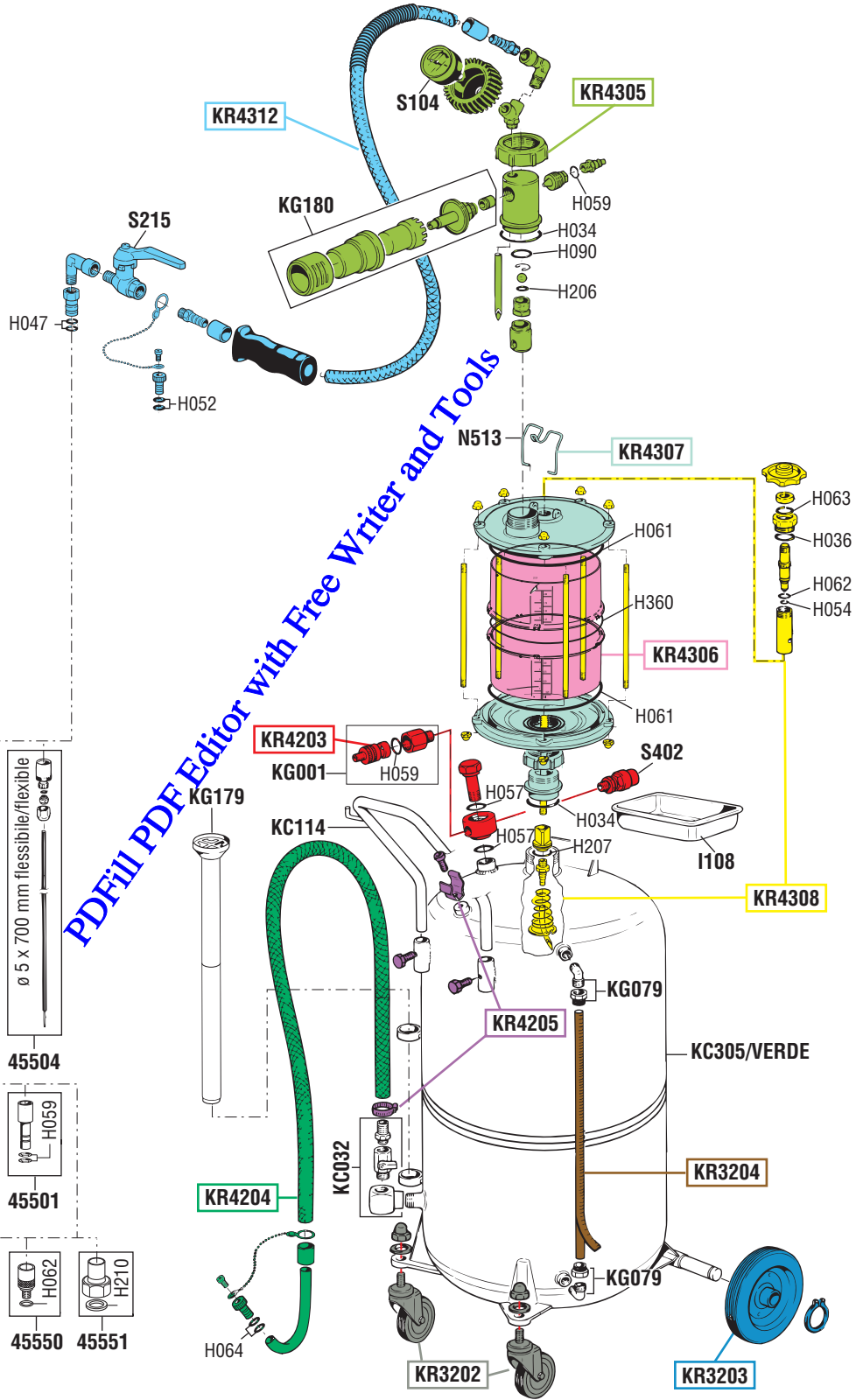

- | | | | |
|--|---|---|--|
| <p>ø 6 x 700 mm flessibile/flexible</p> <p>45506</p> | <p>ø 8 x 700 mm flessibile/flexible</p> <p>45518</p> | <p>ø 5 x 700 mm malleabile/metal</p> <p>45505</p> | <p>ø 5 x 700 mm flessibile/flexible</p> <p>45504</p> |
| <p>ø 6 x 700 mm malleabile/metal</p> <p>45516</p> | <p>ø 7 x 1000 mm flessibile/flexible</p> <p>45517</p> | <p>H053</p> <p>45500</p> | <p>H059</p> <p>45501</p> |
| <p>H202</p> <p>45502</p> | <p>H062</p> <p>45550</p> | <p>H210</p> <p>45551</p> | |

PDFfill PDF Editor with Free Writer and Tools



GUIDA RICAMBI - SPARE PARTS GUIDE

KIT RICAMBI OGNI KIT SOTTO RIPORTATO COMPRENDE I RICAMBI EVIDENZIATI CON LO STESSO COLORE E LE RELATIVE GUARNIZIONI. QUESTI RICAMBI NON SONO FORNIBILI SEPARATAMENTE TRANNE QUELLI CODIFICATI.		
SPARE PARTS KITS EACH KIT SHOWN WITH THE SAME COLOR INCLUDES ALSO THE GASKETS. THE SPARE PARTS INCLUDED IN THE KIT CAN'T BE SUPPLIED SEPARATELY EXCEPT THOSE SHOWN WITH A PROPER CODE.		
CODICE CODE	DESCRIZIONE DESCRIPTION	Q.TÀ QTY
KR3202	DUE RUOTE PIROETTANTI CON DADI TWO SWIVELLING WHEELS WITH NUTS	1
KR3203	2 RUOTE FISSE CON ANELLI ELASTICI 2 FIXED WHEELS WITH RETAINING RINGS	1
KR3204	TUBO DI LIVELLO ED ETICHETTA GAUGE TUBE AND LABEL	1
KR4203	GRUPPO RUBINETTO-VALVOLA DI SICUREZZA AIR TAP AND SAFETY VALVE GROUP	1
KR4204	TUBO SCARICO CON FASCETTA STRINGI TUBO DISCHARGING HOSE WITH HOSE CLAMP	1
KR4205	SET DI VITI PER SERBATOIO SET OF SCREWS FOR RESERVOIR	1
KR4305	GRUPPO ASPIRAZIONE COMPLETO COMPLETE SUCTION GROUP	1
KR4306	CILINDRO - 2 O-RING - ETICHETTA CYLINDER - 2 O-RING - LABEL	1
KR4307	DUE FLANGE PRECAMERA TWO TRANSPARENT BOWL FLANGES	1
KR4308	ACCESSORI PRECAMERA TRANSPARENT BOWL ACCESSORIES	1
KR4312	TUBO ASPIRAZIONE COMPLETO COMPLETE SUCTION HOSE	1

ELENCO RICAMBI FORNIBILI SINGOLARMENTE LIST OF SPARE PARTS WHICH CAN BE SUPPLIED SEPARATELY		
CODICE CODE	DESCRIZIONE DESCRIPTION	Q.TÀ QTY
45500	RACCORDO PER SONDE (VOLKSWAGEN) CONNECTOR FOR PROBES (VOLKSWAGEN)	1
45501	RACCORDO PER SONDE (BMW) CONNECTOR FOR PROBES (BMW)	1
45502	RACCORDO PER SONDE (CITROEN) CONNECTOR FOR PROBES (CITROEN)	1
45504	SONDA ø 5 x 700 FLESSIBILE PROBE ø 5 x 700 FLEXIBLE	1
45505	SONDA ø 5 x 700 METALLO-MALLEABILE PROBE ø 5 x 700 MALLEABLE METAL	1
45506	SONDA ø 6 x 700 FLESSIBILE PROBE ø 6 x 700 FLEXIBLE	1
45516	SONDA ø 6 x 700 METALLO-MALLEABILE PROBE ø 6 x 700 MALLEABLE METAL	1
45517	SONDA ø 7 x 1000 FLESSIBILE PROBE ø 7 x 1000 FLEXIBLE	1
45518	SONDA ø 8 x 700 FLESSIBILE PROBE ø 8 x 700 FLEXIBLE	1
45550	RACCORDO M 3/8" - 16 UNC CONNECTOR 3/8" - 16 UNC	1
45551	RACCORDO F 3/4" - NH CONNECTOR F 3/4" - NH	1
I108	VASCETTA PORTA OGGETTI TOOL TRAY	1
KC032	GRUPPO SCARICO SERBATOIO DISCHARGING GROUP	1
KC114	MANICO A "U" HANDLE	1
KC305/VERDE	SERBATOIO 65 l RESERVOIR 65 l	1
KG001	RUBINETTO UNIVERSALE CARICA ARI UNIVERSAL AIR TAP	1
KG079	GRUPPO GOMITO E GHIERA RING AND ELBOW JOINT GROUP	2
KG179	CONTENITORE PORTA SONDE PROBES CONTAINER	1
KG180	SILENZIATORE COMPLETO COMPLETE MUFFLER	1
N513	LEVA BLOCCA PULSANTE PRECAMERA PRECHAMBER HOOKING LEVER	1
S104	VUOTOMETRO ø 60 mm VACUUM GAUGE ø 60 mm	1
S215	RUBINETTO A SFERA 1/4" BALL VALVE 1/4"	1
S402	VALVOLA DI SICUREZZA 1 bar SAFETY VALVE 1 bar	1

Art. KR4352 KIT GUARNIZIONI COMPLETO COMPOSTO DALLE GUARNIZIONI SOTTO ELENCAE JOINTS GASKETS LIST INCLUDING ALL THE GASKETS SHOWN HERE UNDER		
CODICE CODE	DESCRIZIONE DESCRIPTION	Q.TÀ QTY
H034	O-RING 3156 O-RING 3156	2
H036	O-RING 3093 O-RING 3093	1
H047	O-RING 2050 O-RING 2050	2
H052	O-RING 106 O-RING 106	2
H053	O-RING 2025 O-RING 2025	1
H054	O-RING 2018 O-RING 2018	1
H057	O-RING 2062 O-RING 2062	2
H059	O-RING 2037 O-RING 2037	4
H061	O-RING 4750 O-RING 4750	2
H062	O-RING 109 "NBR 70" O-RING 109 "NBR 70"	1
H063	O-RING 4081 O-RING 4081	1
H064	O-RING 3043 O-RING 3043	2
H090	O-RING 3056 O-RING 3056	1
H202	O-RING 2043 O-RING 2043	2
H206	O-RING 3043 "VITON" O-RING 3043 "VITON"	1
H207	O-RING 4093 "VITON" O-RING 4093 "VITON"	1
H360	O-RING 3775 O-RING 3775	1

Art. KS4386 SET RICAMBI CONSIGLIATI AI PUNTI VENDITA E ASSISTENZA. COMPOSTO DAI RICAMBI SOTTO ELENCAE SPARE PARTS KIT ADVISED TO THE REPAIR CENTERS. THIS KIT INCLUDES ALL THE SPARE PARTS SHOWN HERE UNDER		
CODICE CODE	DESCRIZIONE DESCRIPTION	Q.TÀ QTY
KR4204	TUBO SCARICO CON FASCETTA STRINGI TUBO DISCHARGING HOSE WITH HOSE CLAMP	1
KR4306	CILINDRO - 2 O-RING - ETICHETTA CYLINDER - 2 O-RING - LABEL	1
KR4312	TUBO ASPIRAZIONE COMPLETO COMPLETE SUCTION HOSE	1
KR4352	KIT GUARNIZIONI COMPLETO COMPLETE GASKETS KIT	1
S104	VUOTOMETRO ø 60 mm VACUUM GAUGE ø 60 mm	1



Art. 43790 Mod. AO.90L



VISTA ESPLOSA - EXPLODED VIEW

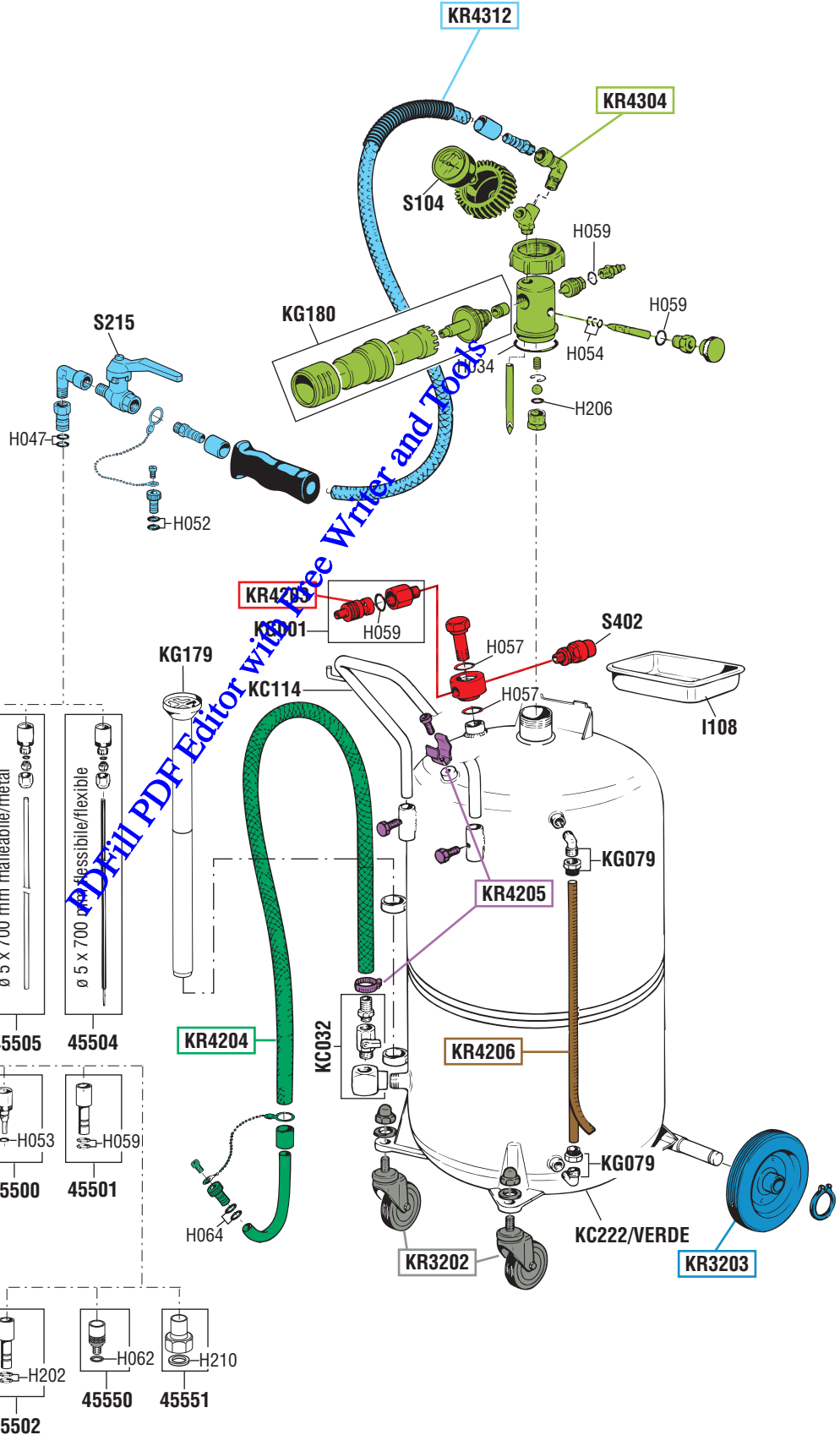

PDF File Editor with Free Writer and Tools

tutti i diritti riservati - all rights reserved



GUIDA RICAMBI - SPARE PARTS GUIDE

KIT RICAMBI OGNI KIT SOTTO RIPORTATO COMPRENDE I RICAMBI EVIDENZIATI CON LO STESSO COLORE E LE RELATIVE GUARNIZIONI. QUESTI RICAMBI NON SONO FORNIBILI SEPARATAMENTE TRANNE QUELLI CODIFICATI.		
SPARE PARTS KITS EACH KIT SHOWN WITH THE SAME COLOR INCLUDES ALSO THE GASKETS. THE SPARE PARTS INCLUDED IN THE KIT CAN'T BE SUPPLIED SEPARATELY EXCEPT THOSE SHOWN WITH A PROPER CODE.		
CODICE CODE	DESCRIZIONE DESCRIPTION	Q.TÀ QTY
KR3202	DUE RUOTE PIROETTANTI CON DADI TWO SWIVELLING WHEELS WITH NUTS	1
KR3203	2 RUOTE FISSI CON ANELLI ELASTICI 2 FIXED WHEELS WITH RETAINING RINGS	1
KR4203	GRUPPO RUBINETTO-VALVOLA DI SICUREZZA AIR TAP AND SAFETY VALVE GROUP	1
KR4204	TUBO SCARICO CON FASCETTA STRINGI TUBO DISCHARGING HOSE WITH HOSE CLAMP	1
KR4205	SET DI VITI PER SERBATOIO SET OF SCREWS FOR RESERVOIR	1
KR4206	TUBO LIVELLO CON ETICHETTA GAUGE TUBE WITH LABEL	1
KR4304	GRUPPO ASPIRAZIONE CON RUBINETTO SUCTION GROUP WITH TAP	1
KR4312	TUBO ASPIRAZIONE COMPLETO COMPLETE SUCTION HOSE	1

ELENCO RICAMBI FORNIBILI SINGOLARMENTE LIST OF SPARE PARTS WHICH CAN BE SUPPLIED SEPARATELY		
CODICE CODE	DESCRIZIONE DESCRIPTION	Q.TÀ QTY
45500	RACCORDO PER SONDE (VOLKSWAGEN) CONNECTOR FOR PROBES (VOLKSWAGEN)	1
45501	RACCORDO PER SONDE (BMW) CONNECTOR FOR PROBES (BMW)	1
45502	RACCORDO PER SONDE (CITROEN) CONNECTOR FOR PROBES (CITROEN)	1
45504	SONDA ø 5 x 700 FLESSIBILE PROBE ø 5 x 700 FLEXIBLE	1
45505	SONDA ø 5 x 700 METALLO-MALLEABILE PROBE ø 5 x 700 MALLEABLE METAL	1
45506	SONDA ø 6 x 700 FLESSIBILE PROBE ø 6 x 700 FLEXIBLE	1
45516	SONDA ø 6 x 700 METALLO-MALLEABILE PROBE ø 6 x 700 MALLEABLE METAL	1
45517	SONDA ø 7 x 1000 FLESSIBILE PROBE ø 7 x 1000 FLEXIBLE	1
45518	SONDA ø 8 x 700 FLESSIBILE PROBE ø 8 x 700 FLEXIBLE	1
45550	RACCORDO M 3/8" - 16 UNC CONNECTOR 3/8" - 16 UNC	1
45551	RACCORDO F 3/4" - NH CONNECTOR F 3/4" - NH	1
I108	VASCHETTA PORTA OGGETTI TOOL TRAY	1
KC032	GRUPPO SCARICO SERBATOIO DISCHARGING GROUP	1
KC114	MANICO A "U" HANDLE	1
KC222/VERDE	SERBATOIO 90 l RESERVOIR 90 l	1
KG001	RUBINETTO UNIVERSALE CARICA ARI UNIVERSAL AIR TAP	1
KG079	GRUPPO GOMITO E GHIERA RING AND ELBOW JOINT GROUP	2
KG179	CONTENITORE PORTA SONDE PROBES CONTAINER	1
KG180	SILENZIATORE COMPLETO COMPLETE MUFFLER	1
S104	VUOTOMETRO ø 60 mm VACUUM GAUGE ø 60 mm	1
S215	RUBINETTO ASPIRAZIONE 1/4" BALL VALVE 1/4"	1
S402	VALVOLA DI SICUREZZA 1 bar SAFETY VALVE 1 bar	1

Art. KR4351 KIT GUARNIZIONI COMPLETO COMPOSTO DALLE GUARNIZIONI SOTTO ELENCAE JOINTS GASKETS LIST INCLUDING ALL THE GASKETS SHOWN HERE UNDER		
CODICE CODE	DESCRIZIONE DESCRIPTION	Q.TÀ QTY
H034	O-RING 3156 O-RING 3156	1
H047	O-RING 2050 O-RING 2050	2
H052	O-RING 106 O-RING 106	2
H053	O-RING 2025 O-RING 2025	1
H054	O-RING 2018 O-RING 2018	3
H057	O-RING 2062 O-RING 2062	2
H059	O-RING 2037 O-RING 2037	6
H064	O-RING 3043 O-RING 3043	2
H202	O-RING 2043 O-RING 2043	2
H206	O-RING 3043 "VITON" O-RING 3043 "VITON"	1

Art. KS4385 SET RICAMBI CONSIGLIATI AI PUNTI VENDITA E ASSISTENZA. COMPOSTO DAI RICAMBI SOTTO ELENCAE SPARE PARTS KIT ADVISED TO THE REPAIR CENTERS. THIS KIT INCLUDES ALL THE SPARE PARTS SHOWN HERE UNDER		
CODICE CODE	DESCRIZIONE DESCRIPTION	Q.TÀ QTY
KR4204	TUBO SCARICO CON FASCETTA STRINGI TUBO DISCHARGING HOSE WITH HOSE CLAMP	1
KR4312	TUBO ASPIRAZIONE COMPLETO COMPLETE SUCTION HOSE	1
KR4351	KIT GUARNIZIONI COMPLETO COMPLETE GASKETS KIT	1
S104	VUOTOMETRO ø 60 mm VACUUM GAUGE ø 60 mm	1



GUIDA RICAMBI - SPARE PARTS GUIDE

KIT RICAMBI OGNI KIT SOTTO RIPORTATO COMPRENDE I RICAMBI EVIDENZIATI CON LO STESSO COLORE E LE RELATIVE GUARNIZIONI. QUESTI RICAMBI NON SONO FORNIBILI SEPARATAMENTE TRANNE QUELLI CODIFICATI.		
SPARE PARTS KITS EACH KIT SHOWN WITH THE SAME COLOR INCLUDES ALSO THE GASKETS. THE SPARE PARTS INCLUDED IN THE KIT CAN'T BE SUPPLIED SEPARATELY EXCEPT THOSE SHOWN WITH A PROPER CODE.		
CODICE CODE	DESCRIZIONE DESCRIPTION	Q.TÀ QTY
KR3202	DUE RUOTE PIROETTANTI CON DADI TWO SWIVELLING WHEELS WITH NUTS	1
KR3203	2 RUOTE FISSE CON ANELLI ELASTICI 2 FIXED WHEELS WITH RETAINING RINGS	1
KR3204	TUBO DI LIVELLO ED ETICHETTA GAUGE TUBE AND LABEL	1
KR4201	COPPA RACCOLTI OLIO OIL COLLECTING BOWL	1
KR4203	GRUPPO RUBINETTO-VALVOLA DI SICUREZZA AIR TAP AND SAFETY VALVE GROUP	1
KR4204	TUBO SCARICO CON FASCETTA STRINGI TUBO DISCHARGING HOSE WITH HOSE CLAMP	1
KR4205	SET DI VITI PER SERBATOIO SET OF SCREWS FOR RESERVOIR	1
KR4207	IMBUTO CON GRIGLIA FUNNEL WITH NET	1
KR4302	TUBO ASPIRAZIONE COMPLETO COMPLETE SUCTION HOSE	1
KR4304	GRUPPO ASPIRAZIONE CON RUBINETTO SUCTION GROUP WITH TAP	1
KR4401	TUBO SUPPORTO COPPA BOWL SUPPORTING TUBE	1
KR4402	TUBO FLESSIBILE PER SERBATOIO 65 l CONNECTING HOSE FOR 65 l RESERVOIR	1

ELENCO RICAMBI FORNIBILI SINGOLARMENTE LIST OF SPARE PARTS WHICH CAN BE SUPPLIED SEPARATELY		
CODICE CODE	DESCRIZIONE DESCRIPTION	Q.TÀ QTY
45500	RACCORDO PER SONDE (VOLKSWAGEN) CONNECTOR FOR PROBES (VOLKSWAGEN)	1
45501	RACCORDO PER SONDE (BMW) CONNECTOR FOR PROBES (BMW)	1
45502	RACCORDO PER SONDE (CITROEN) CONNECTOR FOR PROBES (CITROEN)	1
45504	SONDA ø 5 x 700 FLESSIBILE PROBE ø 5 x 700 FLEXIBLE	1
45505	SONDA ø 5 x 700 METALLO - MALLEABILE PROBE ø 5 x 700 MALLEABLE METAL	1
45506	SONDA ø 6 x 700 FLESSIBILE PROBE ø 6 x 700 FLEXIBLE	1
45516	SONDA ø 6 x 700 METALLO-MALLEABILE PROBE ø 6 x 700 MALLEABLE METAL	1
45517	SONDA ø 7 x 1000 FLESSIBILE PROBE ø 7 x 1000 FLEXIBLE	1
45518	SONDA ø 8 x 700 FLESSIBILE PROBE ø 8 x 700 FLEXIBLE	1
I108	VASCHETTA PORTA OGGETTI TOOL TRAY	1
KC032	GRUPPO SCARICO SERBATOIO DISCHARGING GROUP	1
KC114	MANICO A "U" HANDLE	1
KC298	GRUPPO SCARICO COPPA DISCHARGING GROUP	1
KC309/VERDE	SERBATOIO 65 l RESERVOIR 65 l	1
KC312	GHIERA IRON RING	1
KG001	RUBINETTO UNIVERSALE CARICA ARI UNIVERSAL AIR TAP	1
KG079	GRUPPO GOMITO E GHIERA RING AND ELBOW JOINT GROUP	2
KG179	CONTENITORE PORTA SONDE PROBES CONTAINER	1
KG180	SILENZIATORE COMPLETO COMPLETE MUFFLER	1
S104	VUOTOMETRO ø 60 mm VACUUM GAUGE ø 60 mm	1
S211	RUBINETTO A SFERA 1" BALL VALVE 1"	1
S215	RUBINETTO A SFERA 1/4" BALL VALVE 1/4"	1
S402	VALVOLA DI SICUREZZA 1 bar SAFETY VALVE 1 bar	1

Art. KR4450 KIT GUARNIZIONI COMPLETO COMPOSTO DALLE GUARNIZIONI SOTTO ELENCAE JOINTS GASKETS LIST INCLUDING ALL THE GASKETS SHOWN HERE UNDER		
CODICE CODE	DESCRIZIONE DESCRIPTION	Q.TÀ QTY
H034	O-RING 3156 O-RING 3156	1
H047	O-RING 2050 O-RING 2050	2
H052	O-RING 106 O-RING 106	2
H053	O-RING 2025 O-RING 2025	1
H054	O-RING 2018 O-RING 2018	3
H057	O-RING 2062 O-RING 2062	2
H059	O-RING 2037 O-RING 2037	5
H064	O-RING 3043 O-RING 3043	2
H066	O-RING 3118 O-RING 3118	1
H177	O-RING 4131 O-RING 4131	2
H202	O-RING 2043 O-RING 2043	2
H206	O-RING 3043 "VITON" O-RING 3043 "VITON"	1
I094	OGIVA STRINGI TUBO CLAMPING TUBE OGIVE	1
Art. KS4480 SET RICAMBI CONSIGLIATI AI PUNTI VENDITA E ASSISTENZA. COMPOSTO DAI RICAMBI SOTTO ELENCAE SPARE PARTS KIT ADVISED TO THE REPAIR CENTERS. THIS KIT INCLUDES ALL THE SPARE PARTS SHOWN HERE UNDER		
CODICE CODE	DESCRIZIONE DESCRIPTION	Q.TÀ QTY
KR4204	TUBO SCARICO CON FASCETTA STRINGI TUBO DISCHARGING HOSE WITH HOSE CLAMP	1
KR4302	TUBO ASPIRAZIONE COMPLETO COMPLETE SUCTION HOSE	1
KR4402	TUBO FLESSIBILE PER SERBATOIO 65 l CONNECTING HOSE FOR 65 l RESERVOIR	1
KR4450	KIT GUARNIZIONI COMPLETO COMPLETE GASKETS KIT	1
S104	VUOTOMETRO ø 60 mm VACUUM GAUGE ø 60 mm	1



Art. 44065 Mod. R/AO.C. 65L



VISTA ESPLOSA - EXPLODED VIEW

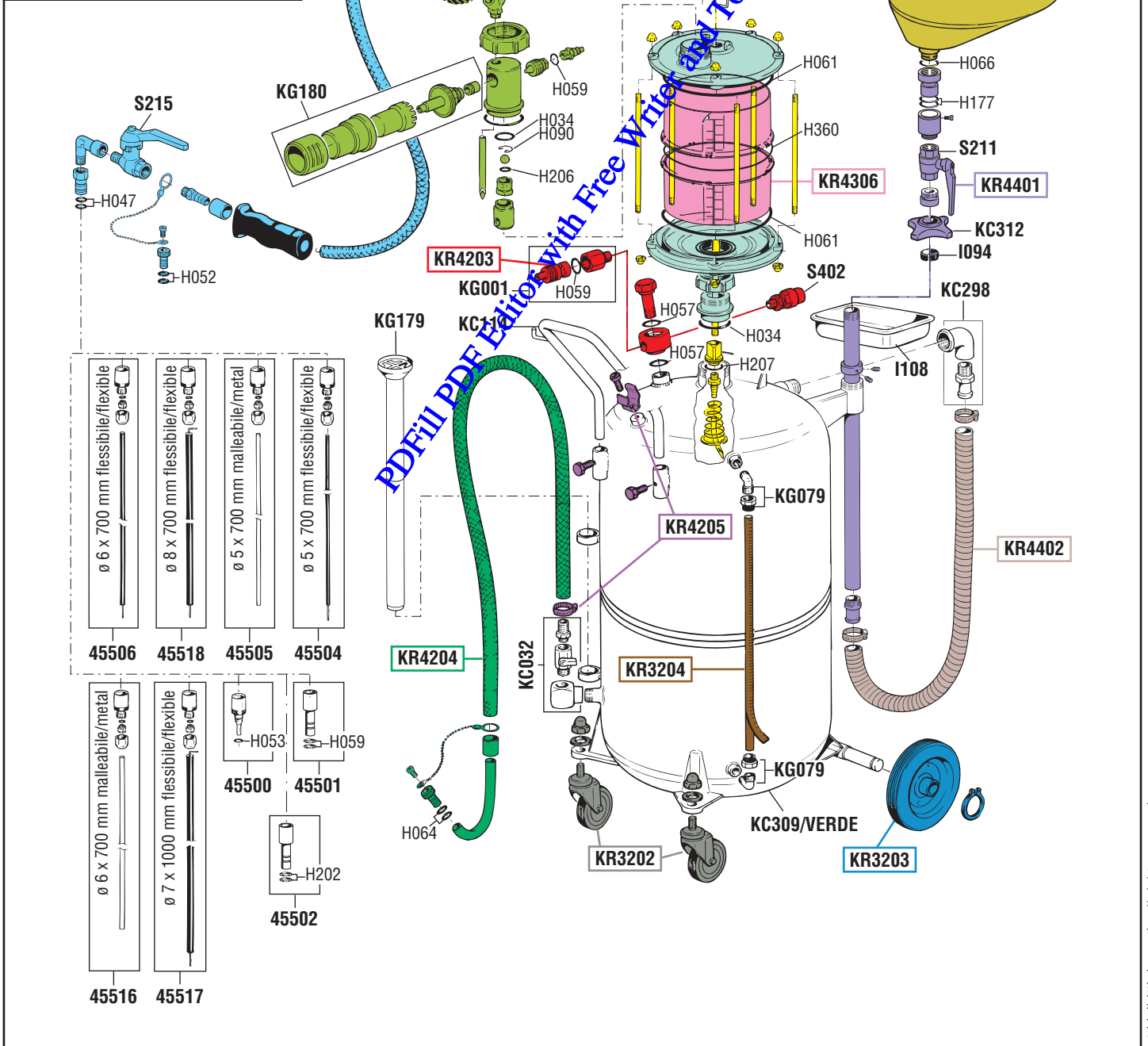

tutti i diritti riservati - all rights reserved

GUIDA RICAMBI - SPARE PARTS GUIDE

KIT RICAMBI
OGNI KIT SOTTO RIPORTATO COMPRENDE I RICAMBI EVIDENZIATI CON LO STESSO COLORE E LE RELATIVE GUARNIZIONI. QUESTI RICAMBI NON SONO FORNIBILI SEPARATAMENTE TRANNE QUELLI CODIFICATI.

SPARE PARTS KITS

EACH KIT SHOWN WITH THE SAME COLOR INCLUDES ALSO THE GASKETS. THE SPARE PARTS INCLUDED IN THE KIT CAN'T BE SUPPLIED SEPARATELY EXCEPT THOSE SHOWN WITH A PROPER CODE.

CODICE CODE	DESCRIZIONE DESCRIPTION	Q.TÀ QTY
KR3202	DUE RUOTE PIROETTANTI CON DADI TWO SWIVELLING WHEELS WITH NUTS	1
KR3203	2 RUOTE FISSE CON ANELLI ELASTICI 2 FIXED WHEELS WITH RETAINING RINGS	1
KR3204	TUBO DI LIVELLO ED ETICHETTA GAUGE TUBE AND LABEL	1
KR4201	COPPA RACCOLTI OLIO OIL COLLECTING BOWL	1
KR4203	GRUPPO RUBINETTO-VALVOLA DI SICUREZZA AIR TAP AND SAFETY VALVE GROUP	1
KR4204	TUBO SCARICO CON FASCETTA STRINGI TUBO DISCHARGING HOSE WITH HOSE CLAMP	1
KR4205	SET DI VITI PER SERBATOIO SET OF SCREWS FOR RESERVOIR	1
KR4207	IMBUTO CON GRIGLIA FUNNEL WITH NET	1
KR4302	TUBO ASPIRAZIONE COMPLETO COMPLETE SUCTION HOSE	1
KR4305	GRUPPO ASPIRAZIONE COMPLETO COMPLETE SUCTION GROUP	1
KR4306	CILINDRO - 2 O-RING - ETICHETTA CYLINDER - 2 O-RING - LABEL	1
KR4307	DUE FLANGE PRECAMERA TWO TRANSPARENT BOWL FLANGES	1
KR4308	ACCESSORI PRECAMERA TRANSPARENT BOWL ACCESSORIES	1
KR4401	TUBO SUPPORTO COPPA BOWL SUPPORTING TUBE	1
KR4402	TUBO FLESSIBILE PER SERBATOIO 65 l CONNECTING HOSE FOR 65 l RESERVOIR	1

ELENCO RICAMBI FORNIBILI SINGOLARMENTE

LIST OF SPARE PARTS WHICH CAN BE SUPPLIED SEPARATELY

CODICE CODE	DESCRIZIONE DESCRIPTION	Q.TÀ QTY
45500	RACCORDO PER SONDE (VOLKSWAGEN) CONNECTOR FOR PROBES (VOLKSWAGEN)	1
45501	RACCORDO PER SONDE (BMW) CONNECTOR FOR PROBES (BMW)	1
45502	RACCORDO PER SONDE (CITROEN) CONNECTOR FOR PROBES (CITROEN)	1
45504	SONDA ø 5 x 700 FLESSIBILE PROBE ø 5 x 700 FLEXIBLE	1
45505	SONDA ø 5 x 700 METALLO-MALLEABILE PROBE ø 5 x 700 MALLEABLE METAL	1
45506	SONDA ø 6 x 700 FLESSIBILE PROBE ø 6 x 700 FLEXIBLE	1
45516	SONDA ø 6 x 700 METALLO-MALLEABILE PROBE ø 6 x 700 MALLEABLE METAL	1
45517	SONDA ø 7 x 1000 FLESSIBILE PROBE ø 7 x 1000 FLEXIBLE	1
45518	SONDA ø 8 x 700 FLESSIBILE PROBE ø 8 x 700 FLEXIBLE	1
I108	VASCHETTA PORTA OGGETTI TOOL TRAY	1
KC032	GRUPPO SCARICO SERBATOIO DISCHARGING GROUP	1
KC114	MANICO A "U" HANDLE	1
KC298	GRUPPO SCARICO COPPA DISCHARGING GROUP	1
KC309/VERDE	SERBATOIO 65 l RESERVOIR 65 l	1
KC312	GHIERA IRON RING	1
KG001	RUBINETTO UNIVERSALE CARICA ARI UNIVERSAL AIR TAP	1
KG079	GRUPPO GOMITO E GHIERA RING AND ELBOW JOINT GROUP	2
KG179	CONTENITORE PORTA SONDE PROBES CONTAINER	1
KG180	SILENZIATORE COMPLETO COMPLETE MUFFLER	1
N513	LEVA BLOCCA PULSANTE PRECAMERA PRECHAMBER HOIKING LEVER	1
S104	VUOTOMETRO ø 60 mm VACUUM GAUGE ø 60 mm	1
S211	RUBINETTO A SFERA 1" BALL VALVE 1"	1
S215	RUBINETTO A SFERA 1/4" BALL VALVE 1/4"	1
S402	VALVOLA DI SICUREZZA 1 bar SAFETY VALVE 1 bar	1

Art. KR4451
KIT GUARNIZIONI COMPLETO
COMPOSTO DALLE GUARNIZIONI SOTTO ELENCAE
JOINTS GASKETS LIST
INCLUDING ALL THE GASKETS SHOWN HERE UNDER

CODICE CODE	DESCRIZIONE DESCRIPTION	Q.TÀ QTY
H034	O-RING 3156 O-RING 3156	2
H036	O-RING 3093 O-RING 3093	1
H047	O-RING 2050 O-RING 2050	2
H052	O-RING 106 O-RING 106	2
H053	O-RING 2025 O-RING 2025	1
H054	O-RING 2018 O-RING 2018	1
H057	O-RING 2062 O-RING 2062	2
H059	O-RING 2037 O-RING 2037	4
H061	O-RING 4750 O-RING 4750	2
H062	O-RING 109 "NBR 70" O-RING 109 "NBR 70"	1
H063	O-RING 4081 O-RING 4081	1
H064	O-RING 3043 O-RING 3043	2
H066	O-RING 3118 O-RING 3118	1
H090	O-RING 3056 O-RING 3056	1
H177	O-RING 4131 O-RING 4131	2
H202	O-RING 2043 O-RING 2043	2
H206	O-RING 3043 "VITON" O-RING 3043 "VITON"	1
H207	O-RING 4093 "VITON" O-RING 4093 "VITON"	1
H360	O-RING 3775 O-RING 3775	1
I094	OGIVA STRINGI TUBO CLAMPING TUBE OGIVE	1

Art. KS4481
SET RICAMBI CONSIGLIATI
AI PUNTI VENDITA E ASSISTENZA,
COMPOSTO DAI RICAMBI SOTTO ELENCAE
SPARE PARTS KIT ADVISED
TO THE REPAIR CENTERS. THIS KIT INCLUDES
ALL THE SPARE PARTS SHOWN HERE UNDER

CODICE CODE	DESCRIZIONE DESCRIPTION	Q.TÀ QTY
KR4204	TUBO SCARICO CON FASCETTA STRINGI TUBO DISCHARGING HOSE WITH HOSE CLAMP	1
KR4302	TUBO ASPIRAZIONE COMPLETO COMPLETE SUCTION HOSE	1
KR4306	CILINDRO - 2 O-RING - ETICHETTA CYLINDER - 2 O-RING - LABEL	1
KR4402	TUBO FLESSIBILE PER SERBATOIO 65 l CONNECTING HOSE FOR 65 l RESERVOIR	1
KR4451	KIT GUARNIZIONI COMPLETO COMPLETE GASKETS KIT	1
S104	VUOTOMETRO ø 60 mm VACUUM GAUGE ø 60 mm	1

GUIDA RICAMBI - SPARE PARTS GUIDE

KIT RICAMBI OGNI KIT SOTTO RIPORTATO COMPRENDE I RICAMBI EVIDENZIATI CON LO STESSO COLORE E LE RELATIVE GUARNIZIONI. QUESTI RICAMBI NON SONO FORNIBILI SEPARATAMENTE TRANNE QUELLI CODIFICATI.		
SPARE PARTS KITS EACH KIT SHOWN WITH THE SAME COLOR INCLUDES ALSO THE GASKETS. THE SPARE PARTS INCLUDED IN THE KIT CAN'T BE SUPPLIED SEPARATELY EXCEPT THOSE SHOWN WITH A PROPER CODE.		
CODICE CODE	DESCRIZIONE DESCRIPTION	Q.TÀ QTY
KR3202	DUE RUOTE PIROETTANTI CON DADI TWO SWIVELLING WHEELS WITH NUTS	1
KR3203	2 RUOTE FISSE CON ANELLI ELASTICI 2 FIXED WHEELS WITH RETAINING RINGS	1
KR3204	TUBO DI LIVELLO ED ETICHETTA GAUGE TUBE AND LABEL	1
KR4201	COPPA RACCOLTI OLIO OIL COLLECTING BOWL	1
KR4203	GRUPPO RUBINETTO-VALVOLA DI SICUREZZA AIR TAP AND SAFETY VALVE GROUP	1
KR4207	IMBUTO CON GRIGLIA FUNNEL WITH NET	1
KR4229	SET DI VITI PER SERBATOIO SET OF SCREWS FOR RESERVOIR	1
KR4302	TUBO ASPIRAZIONE COMPLETO COMPLETE SUCTION HOSE	1
KR4305	GRUPPO ASPIRAZIONE COMPLETO COMPLETE SUCTION GROUP	1
KR4306	CILINDRO - 2 O-RING - ETICHETTA CYLINDER - 2 O-RING - LABEL	1
KR4307	DUE FLANGE PRECAMERA TWO TRANSPARENT BOWL FLANGES	1
KR4308	ACCESSORI PRECAMERA TRANSPARENT BOWL ACCESSORIES	1
KR4401	TUBO SUPPORTO COPPA BOWL SUPPORTING TUBE	1
KR4402	TUBO FLESSIBILE PER SERBATOIO 65 l CONNECTING HOSE FOR 65 l RESERVOIR	1

ELENCO RICAMBI FORNIBILI SINGOLARMENTE LIST OF SPARE PARTS WHICH CAN BE SUPPLIED SEPARATELY		
CODICE CODE	DESCRIZIONE DESCRIPTION	Q.TÀ QTY
33118	NIPPLE M 1/2" G x M 3/4" G NIPPLE M 1/2" G x M 3/4" G	1
33127	ATTACCO RAPIDO MASCHIO MALE QUICK CONNECTION	1
45500	RACCORDO PER SONDE (VOLKSWAGEN) CONNECTOR FOR PROBES (VOLKSWAGEN)	1
45501	RACCORDO PER SONDE (BMW) CONNECTOR FOR PROBES (BMW)	1
45502	RACCORDO PER SONDE (CITROEN) CONNECTOR FOR PROBES (CITROEN)	1
45504	SONDA ø 5 x 700 FLESSIBILE PROBE ø 5 x 700 FLEXIBLE	1
45505	SONDA ø 5 x 700 METALLO-MALLEABILE PROBE ø 5 x 700 MALLEABLE METAL	1
45506	SONDA ø 6 x 700 FLESSIBILE PROBE ø 6 x 700 FLEXIBLE	1
45516	SONDA ø 6 x 700 METALLO-MALLEABILE PROBE ø 6 x 700 MALLEABLE METAL	1
45517	SONDA ø 7 x 1000 FLESSIBILE PROBE ø 7 x 1000 FLEXIBLE	1
45518	SONDA ø 8 x 700 FLESSIBILE PROBE ø 8 x 700 FLEXIBLE	1
I108	VASCETTA PORTA OGGETTI TOOL TRAY	1
KC114	MANICO A "U" HANDLE	1
KC298	GRUPPO SCARICO COPPA DISCHARGING GROUP	1
KC309/VERDE	SERBATOIO 65 l RESERVOIR 65 l	1
KC312	GHERA IRON RING	1
KG001	RUBINETTO UNIVERSALE CARICA ARIA UNIVERSAL AIR TAP	1
KG079	GRUPPO GOMITO E GHERA RING AND ELBOW JOINT GROUP	2
KG179	CONTENITORE PORTA SONDE PROBES CONTAINER	1
KG180	SILENZIATORE COMPLETO COMPLETE MUFFLER	1
N513	LEVA BLOCCA-PULSANTE PRECAMERA PRECHAMBER TROKING LEVER	1
S104	VUOTOMETRO ø 60 mm VACUUM GAUGE ø 60 mm	1
S203	RUBINETTO A SFERA 1/2" BALL VALVE 1/2"	1
S211	RUBINETTO A SFERA 1" BALL VALVE 1"	1
S215	RUBINETTO A SFERA 1/4" BALL VALVE 1/4"	1
S402	VALVOLA DI SICUREZZA 1 bar SAFETY VALVE 1 bar	1

Art. KR4451 KIT GUARNIZIONI COMPLETO COMPOSTO DALLE GUARNIZIONI SOTTO ELENCAE JOINTS GASKETS LIST INCLUDING ALL THE GASKETS SHOWN HERE UNDER		
CODICE CODE	DESCRIZIONE DESCRIPTION	Q.TÀ QTY
H034	O-RING 3156 O-RING 3156	2
H036	O-RING 3093 O-RING 3093	1
H047	O-RING 2050 O-RING 2050	2
H052	O-RING 106 O-RING 106	2
H053	O-RING 2025 O-RING 2025	1
H054	O-RING 2018 O-RING 2018	1
H057	O-RING 2062 O-RING 2062	2
H059	O-RING 2037 O-RING 2037	4
H061	O-RING 4750 O-RING 4750	2
H062	O-RING 109 "NBR 70" O-RING 109 "NBR 70"	1
H063	O-RING 4081 O-RING 4081	1
H064	O-RING 3043 O-RING 3043	2
H066	O-RING 3118 O-RING 3118	1
H090	O-RING 3056 O-RING 3056	1
H177	O-RING 4131 O-RING 4131	2
H202	O-RING 2043 O-RING 2043	2
H206	O-RING 3043 "VITON" O-RING 3043 "VITON"	1
H207	O-RING 4093 "VITON" O-RING 4093 "VITON"	1
H360	O-RING 3775 O-RING 3775	1
I094	OGIVA STRINGI TUBO CLAMPING TUBE OGIVE	1

Art. KS4488 SET RICAMBI CONSIGLIATI AI PUNTI VENDITA E ASSISTENZA. COMPOSTO DAI RICAMBI SOTTO ELENCAE SPARE PARTS KIT ADVISED TO THE REPAIR CENTERS. THIS KIT INCLUDES ALL THE SPARE PARTS SHOWN HERE UNDER		
CODICE CODE	DESCRIZIONE DESCRIPTION	Q.TÀ QTY
KR4302	TUBO ASPIRAZIONE COMPLETO COMPLETE SUCTION HOSE	1
KR4306	CILINDRO - 2 O-RING - ETICHETTA CYLINDER - 2 O-RING - LABEL	1
KR4402	TUBO FLESSIBILE PER SERBATOIO 65 l CONNECTING HOSE FOR 65 l RESERVOIR	1
KR4451	KIT GUARNIZIONI COMPLETO COMPLETE GASKETS KIT	1
S104	VUOTOMETRO ø 60 mm VACUUM GAUGE ø 60 mm	1

GUIDA RICAMBI - SPARE PARTS GUIDE

KIT RICAMBI
OGNI KIT SOTTO RIPORTATO COMPRENDE I RICAMBI EVIDENZIATI CON LO STESSO COLORE E LE RELATIVE GUARNIZIONI. QUESTI RICAMBI NON SONO FORNIBILI SEPARATAMENTE TRANNE QUELLI CODIFICATI.

SPARE PARTS KITS

EACH KIT SHOWN WITH THE SAME COLOR INCLUDES ALSO THE GASKETS. THE SPARE PARTS INCLUDED IN THE KIT CAN'T BE SUPPLIED SEPARATELY EXCEPT THOSE SHOWN WITH A PROPER CODE.

CODICE CODE	DESCRIZIONE DESCRIPTION	Q.TÀ QTY
KR3202	DUE RUOTE PIROETTANTI CON DADI TWO SWIVELLING WHEELS WITH NUTS	1
KR3203	2 RUOTE FISSE CON ANELLI ELASTICI 2 FIXED WHEELS WITH RETAINING RINGS	1
KR3204	TUBO DI LIVELLO ED ETICHETTA GAUGE TUBE AND LABEL	1
KR4201	COPPA RACCOLGI OLIO OIL COLLECTING BOWL	1
KR4207	IMBUTO CON GRIGLIA FUNNEL WITH NET	1
KR4229	SET DI VITI PER SERBATOIO SET OF SCREWS FOR RESERVOIR	1
KR4230	GR. RUBINETTO CON REG. PRESSIONE AIR TAP GROUP WITH PRESSURE REGULATOR	1
KR4302	TUBO ASPIRAZIONE COMPLETO COMPLETE SUCTION HOSE	1
KR4305	GRUPPO ASPIRAZIONE COMPLETO COMPLETE SUCTION GROUP	1
KR4306	CILINDRO - 2 O-RING - ETICHETTA CYLINDER - 2 O-RING - LABEL	1
KR4307	DUE FLANGE PRECAMERA TWO TRANSPARENT BOWL FLANGES	1
KR4308	ACCESSORI PRECAMERA TRANSPARENT BOWL ACCESSORIES	1
KR4401	TUBO SUPPORTO COPPA BOWL SUPPORTING TUBE	1
KR4402	TUBO FLESSIBILE PER SERBATOIO 65 l CONNECTING HOSE FOR 65 l RESERVOIR	1

ELENCO RICAMBI FORNIBILI SINGOLARMENTE

LIST OF SPARE PARTS WHICH CAN BE SUPPLIED SEPARATELY

CODICE CODE	DESCRIZIONE DESCRIPTION	Q.TÀ QTY
33118	NIPPLE M 1/2" G x M 3/4" G NIPPLE M 1/2" G x M 3/4" G	1
33127	ATTACCO RAPIDO MASCHIO MALE QUICK CONNECTION	1
45500	RACCORDO PER SONDE (VOLKSWAGEN) CONNECTOR FOR PROBES (VOLKSWAGEN)	1
45501	RACCORDO PER SONDE (BMW/ CONNECTOR FOR PROBES (BMW)	1
45502	RACCORDO PER SONDE (CITROEN) CONNECTOR FOR PROBES (CITROEN)	1
45504	SONDA ø 5 x 700 FLESSIBILE PROBE ø 5 x 700 FLEXIBLE	1
45505	SONDA ø 5 x 700 METALLO-MALLEABILE PROBE ø 5 x 700 MALLEABLE METAL	1
45506	SONDA ø 6 x 700 FLESSIBILE PROBE ø 6 x 700 FLEXIBLE	1
45516	SONDA ø 6 x 700 METALLO-MALLEABILE PROBE ø 6 x 700 MALLEABLE METAL	1
45517	SONDA ø 7 x 1000 FLESSIBILE PROBE ø 7 x 1000 FLEXIBLE	1
45518	SONDA ø 8 x 700 FLESSIBILE PROBE ø 8 x 700 FLEXIBLE	1
I108	VASCETTA PORTA OGGETTI TOOL TRAY	1
KC114	MANICO A "U" HANDLE	1
KC298	GRUPPO SCARICO COPPA DISCHARGING GROUP	1
KC309/VERDE	SERBATOIO 65 l RESERVOIR 65 l	1
KC312	GHIERA IRON RING	1
KG079	GRUPPO GOMITO E GHIERA RING AND ELBOW JOINT GROUP	2
KG179	CONTENITORE PORTA SONDE PROBES CONTAINER	1
KG180	SILENZIATORE COMPLETO COMPLETE MUFFLER	1
N513	LEVA BLOCCA PULSANTE PRECAMERA PRECHAMBER HOOKING LEVER	1
S101	MANOMETRO ø 60 mm GAUGE ø 60 mm	1
S104	VUOTOMETRO ø 60 mm VACUUM GAUGE ø 60 mm	1
S203	RUBINETTO A SFERA 1/2" BALL VALVE 1/2"	1
S211	RUBINETTO A SFERA 1" BALL VALVE 1"	1
S215	RUBINETTO A SFERA 1/4" BALL VALVE 1/4"	1
S301	REGOLATORE DI PRESSIONE 1/4" PRESSURE REGULATOR 1/4"	1
S402	VALVOLA DI SICUREZZA 1 bar SAFETY VALVE 1 bar	1

Art. KR4451	KIT GUARNIZIONI COMPLETO COMPOSTO DALLE GUARNIZIONI SOTTO ELENCAE JOINTS GASKETS LIST INCLUDING ALL THE GASKETS SHOWN HERE UNDER	
CODICE CODE	DESCRIZIONE DESCRIPTION	Q.TÀ QTY
H034	O-RING 3156 O-RING 3156	2
H036	O-RING 3093 O-RING 3093	1
H047	O-RING 2050 O-RING 2050	2
H052	O-RING 106 O-RING 106	2
H053	O-RING 2025 O-RING 2025	1
H054	O-RING 2018 O-RING 2018	1
H057	O-RING 2062 O-RING 2062	2
H059	O-RING 2037 O-RING 2037	4
H061	O-RING 4750 O-RING 4750	2
H062	O-RING 109 "NBR 70" O-RING 109 "NBR 70"	1
H063	O-RING 4081 O-RING 4081	1
H064	O-RING 3043 O-RING 3043	2
H066	O-RING 3118 O-RING 3118	1
H090	O-RING 3056 O-RING 3056	1
H177	O-RING 4131 O-RING 4131	2
H202	O-RING 2043 O-RING 2043	2
H206	O-RING 3043 "VITON" O-RING 3043 "VITON"	1
H207	O-RING 4093 "VITON" O-RING 4093 "VITON"	1
H360	O-RING 3775 O-RING 3775	1
I094	OGIVA STRINGI TUBO CLAMPING TUBE OGIVE	1

Art. KS4488	SET RICAMBI CONSIGLIATI AI PUNTI VENDITA E ASSISTENZA, COMPOSTO DAI RICAMBI SOTTO ELENCATI SPARE PARTS KIT ADVISED TO THE REPAIR CENTERS. THIS KIT INCLUDES ALL THE SPARE PARTS SHOWN HERE UNDER	
CODICE CODE	DESCRIZIONE DESCRIPTION	Q.TÀ QTY
KR4302	TUBO ASPIRAZIONE COMPLETO COMPLETE SUCTION HOSE	1
KR4306	CILINDRO - 2 O-RING - ETICHETTA CYLINDER - 2 O-RING - LABEL	1
KR4402	TUBO FLESSIBILE PER SERBATOIO 65 l CONNECTING HOSE FOR 65 l RESERVOIR	1
KR4451	KIT GUARNIZIONI COMPLETO COMPLETE GASKETS KIT	1
S104	VUOTOMETRO ø 60 mm VACUUM GAUGE ø 60 mm	1



GUIDA RICAMBI - SPARE PARTS GUIDE

KIT RICAMBI OGNI KIT SOTTO RIPORTATO COMPRENDE I RICAMBI EVIDENZIATI CON LO STESSO COLORE E LE RELATIVE GUARNIZIONI. QUESTI RICAMBI NON SONO FORNIBILI SEPARATAMENTE TRANNE QUELLI CODIFICATI.		
SPARE PARTS KITS EACH KIT SHOWN WITH THE SAME COLOR INCLUDES ALSO THE GASKETS. THE SPARE PARTS INCLUDED IN THE KIT CAN'T BE SUPPLIED SEPARATELY EXCEPT THOSE SHOWN WITH A PROPER CODE.		
CODICE CODE	DESCRIZIONE DESCRIPTION	Q.TÀ QTY
KR3202	DUE RUOTE PIROETTANTI CON DADI TWO SWIVELLING WHEELS WITH NUTS	1
KR3203	2 RUOTE FISSE CON ANELLI ELASTICI 2 FIXED WHEELS WITH RETAINING RINGS	1
KR4201	COPPA RACCOGLI OLIO OIL COLLECTING BOWL	1
KR4203	GRUPPO RUBINETTO-VALVOLA DI SICUREZZA AIR TAP AND SAFETY VALVE GROUP	1
KR4204	TUBO SCARICO CON FASCETTA STRINGI TUBO DISCHARGING HOSE WITH HOSE CLAMP	1
KR4205	SET DI VITI PER SERBATOIO SET OF SCREWS FOR RESERVOIR	1
KR4206	TUBO LIVELLO CON ETICHETTA GAUGE TUBE WITH LABEL	1
KR4207	IMBUTO CON GRIGLIA FUNNEL WITH NET	1
KR4302	TUBO ASPIRAZIONE COMPLETO COMPLETE SUCTION HOSE	1
KR4304	GRUPPO ASPIRAZIONE CON RUBINETTO SUCTION GROUP WITH TAP	1
KR4401	TUBO SUPPORTO COPPA BOWL SUPPORTING TUBE	1
KR4403	TUBO FLESSIBILE PER SERBATOIO 90 l CONNECTION HOSE FOR 90 l RESERVOIR	1

ELENCO RICAMBI FORNIBILI SINGOLARMENTE LIST OF SPARE PARTS WHICH CAN BE SUPPLIED SEPARATELY		
CODICE CODE	DESCRIZIONE DESCRIPTION	Q.TÀ QTY
45500	RACCORDO PER SONDE (VOLKSWAGEN) CONNECTOR FOR PROBES (VOLKSWAGEN)	1
45501	RACCORDO PER SONDE (BMW) CONNECTOR FOR PROBES (BMW)	1
45502	RACCORDO PER SONDE (CITROEN) CONNECTOR FOR PROBES (CITROEN)	1
45504	SONDA ø 5 x 700 FLESSIBILE PROBE ø 5 x 700 FLEXIBLE	1
45505	SONDA ø 5 x 700 METALLO-MALLEABILE PROBE ø 5 x 700 MALLEABLE METAL	1
45506	SONDA ø 6 x 700 FLESSIBILE PROBE ø 6 x 700 FLEXIBLE	1
45516	SONDA ø 6 x 700 METALLO-MALLEABILE PROBE ø 6 x 700 MALLEABLE METAL	1
45517	SONDA ø 7 x 1000 FLESSIBILE PROBE ø 7 x 1000 FLEXIBLE	1
45518	SONDA ø 8 x 700 FLESSIBILE PROBE ø 8 x 700 FLEXIBLE	1
I108	VASCHETTA PORTA OGGETTI TOOL TRAY	1
KC032	GRUPPO SCARICO SERBATOIO DISCHARGING GROUP	1
KC114	MANICO A "U" HANDLE	1
KC226/VERDE	SERBATOIO 90 l RESERVOIR 90 l	1
KC298	GRUPPO SCARICO COPPA DISCHARGING GROUP	1
KC312	GHIERA IRON RING	1
KG001	RUBINETTO UNIVERSALE CARICA ARI UNIVERSAL AIR TAP	1
KG079	GRUPPO GOMITO E GHIERA RING AND ELBOW JOINT GROUP	2
KG179	CONTENITORE PORTA SONDE PROBES CONTAINER	1
KG180	SILENZIATORE COMPLETO COMPLETE MUFFLER	1
S104	VUOTOMETRO ø 60 mm VACUUM GAUGE ø 60 mm	1
S211	RUBINETTO A SFERA 1" BALL VALVE 1"	1
S215	RUBINETTO A SFERA 1/4" BALL VALVE 1/4"	1
S402	VALVOLA DI SICUREZZA 1 bar SAFETY VALVE 1 bar	1

Art. KR4450 KIT GUARNIZIONI COMPLETO COMPOSTO DALLE GUARNIZIONI SOTTO ELENCAE JOINTS GASKETS LIST INCLUDING ALL THE GASKETS SHOWN HERE UNDER		
CODICE CODE	DESCRIZIONE DESCRIPTION	Q.TÀ QTY
H034	O-RING 3156 O-RING 3156	1
H047	O-RING 2050 O-RING 2050	2
H052	O-RING 106 O-RING 106	2
H053	O-RING 2025 O-RING 2025	1
H054	O-RING 2018 O-RING 2018	3
H057	O-RING 2062 O-RING 2062	2
H059	O-RING 2037 O-RING 2037	5
H064	O-RING 3043 O-RING 3043	2
H066	O-RING 3118 O-RING 3118	1
H177	O-RING 4131 O-RING 4131	2
H202	O-RING 2043 O-RING 2043	2
H206	O-RING 3043 "VITON" O-RING 3043 "VITON"	1
I094	OGIVA STRINGI TUBO CLAMPING TUBE OGIVE	1
Art. KS4482 SET RICAMBI CONSIGLIATI AI PUNTI VENDITA E ASSISTENZA. COMPOSTO DAI RICAMBI SOTTO ELENCAE SPARE PARTS KIT ADVISED TO THE REPAIR CENTERS. THIS KIT INCLUDES ALL THE SPARE PARTS SHOWN HERE UNDER		
CODICE CODE	DESCRIZIONE DESCRIPTION	Q.TÀ QTY
KR4204	TUBO SCARICO CON FASCETTA STRINGI TUBO DISCHARGING HOSE WITH HOSE CLAMP	1
KR4302	TUBO ASPIRAZIONE COMPLETO COMPLETE SUCTION HOSE	1
KR4403	TUBO FLESSIBILE PER SERBATOIO 90 l CONNECTION HOSE FOR 90 l RESERVOIR	1
KR4450	KIT GUARNIZIONI COMPLETO COMPLETE GASKETS KIT	1
S104	VUOTOMETRO ø 60 mm VACUUM GAUGE ø 60 mm	1

GUIDA RICAMBI - SPARE PARTS GUIDE

KIT RICAMBI
OGNI KIT SOTTO RIPORTATO COMPRENDE I RICAMBI EVIDENZIATI CON LO STESSO COLORE E LE RELATIVE GUARNIZIONI. QUESTI RICAMBI NON SONO FORNIBILI SEPARATAMENTE TRANNE QUELLI CODIFICATI.

SPARE PARTS KITS

EACH KIT SHOWN WITH THE SAME COLOR INCLUDES ALSO THE GASKETS. THE SPARE PARTS INCLUDED IN THE KIT CAN'T BE SUPPLIED SEPARATELY EXCEPT THOSE SHOWN WITH A PROPER CODE.

CODICE CODE	DESCRIZIONE DESCRIPTION	Q. TÀ QTY
KR3202	DUE RUOTE PIROETTANTI CON DADI TWO SWIVELLING WHEELS WITH NUTS	1
KR3203	2 RUOTE FISSE CON ANELLI ELASTICI 2 FIXED WHEELS WITH RETAINING RINGS	1
KR4201	COPPA RACCOGLI OLIO OIL COLLECTING BOWL	1
KR4203	GRUPPO RUBINETTO-VALVOLA DI SICUREZZA AIR TAP AND SAFETY VALVE GROUP	1
KR4204	TUBO SCARICO CON FASCETTA STRINGI TUBO DISCHARGING HOSE WITH HOSE CLAMP	1
KR4205	SET DI VITI PER SERBATOIO SET OF SCREWS FOR RESERVOIR	1
KR4206	TUBO LIVELLO CON ETICHETTA GAUGE TUBE WITH LABEL	1
KR4207	IMBUTO CON GRIGLIA FUNNEL WITH NET	1
KR4302	TUBO ASPIRAZIONE COMPLETO COMPLETE SUCTION HOSE	1
KR4305	GRUPPO ASPIRAZIONE COMPLETO COMPLETE SUCTION GROUP	1
KR4306	CILINDRO - 2 O-RING - ETICHETTA CYLINDER - 2 O-RING - LABEL	1
KR4307	DUE FLANGE PRECAMERA TWO TRANSPARENT BOWL FLANGES	1
KR4308	ACCESSORI PRECAMERA TRANSPARENT BOWL ACCESSORIES	1
KR4401	TUBO SUPPORTO COPPA BOWL SUPPORTING TUBE	1
KR4403	TUBO FLESSIBILE PER SERBATOIO 90 l CONNECTION HOSE FOR 90 l RESERVOIR	1

ELENCO RICAMBI FORNIBILI SINGOLARMENTE

LIST OF SPARE PARTS WHICH CAN BE SUPPLIED SEPARATELY

CODICE CODE	DESCRIZIONE DESCRIPTION	Q. TÀ QTY
45500	RACCORDO PER SONDE (VOLKSWAGEN) CONNECTOR FOR PROBES (VOLKSWAGEN)	1
45501	RACCORDO PER SONDE (BMW) CONNECTOR FOR PROBES (BMW)	1
45502	RACCORDO PER SONDE (CITROEN) CONNECTOR FOR PROBES (CITROEN)	1
45504	SONDA ø 5 x 700 FLESSIBILE PROBE ø 5 x 700 FLEXIBLE	1
45505	SONDA ø 5 x 700 METALLO-MALLEABILE PROBE ø 5 x 700 MALLEABLE METAL	1
45506	SONDA ø 6 x 700 FLESSIBILE PROBE ø 6 x 700 FLEXIBLE	1
45516	SONDA ø 6 x 700 METALLO-MALLEABILE PROBE ø 6 x 700 MALLEABLE METAL	1
45517	SONDA ø 7 x 1000 FLESSIBILE PROBE ø 7 x 1000 FLEXIBLE	1
45518	SONDA ø 8 x 700 FLESSIBILE PROBE ø 8 x 700 FLEXIBLE	1
I108	VASCHETTA PORTA OGGETTI TOOL TRAY	1
KC032	GRUPPO SCARICO SERBATOIO DISCHARGING GROUP	1
KC114	MANICO A "U" HANDLE	1
KC226/VERDE	SERBATOIO 90 l RESERVOIR 90 l	1
KC298	GRUPPO SCARICO COPPA DISCHARGING GROUP	1
KC312	GHIERA IRON RING	1
KG001	RUBINETTO UNIVERSALE CARICA ARI UNIVERSAL AIR TAP	1
KG079	GRUPPO GOMITO E GHIERA RING AND ELBOW JOINT GROUP	2
KG179	CONTENITORE PORTA SONDE PROBES CONTAINER	1
KG180	SILENZIATORE COMPLETO COMPLETE MUFFLER	1
N513	LEVA BLOCCA PULSANTE PRECAMERA PRECHAMBER HOODING LEVER	1
S104	VUOTOMETRO ø 60 mm VACUUM GAUGE ø 60 mm	1
S211	RUBINETTO A SFERA 1" BALL VALVE 1"	1
S215	RUBINETTO A SFERA 1/4" BALL VALVE 1/4"	1
S402	VALVOLA DI SICUREZZA 1 bar SAFETY VALVE 1 bar	1

Art. KR4451	DESCRIZIONE DESCRIPTION	Q. TÀ QTY
H034	O-RING 3156 O-RING 3156	2
H036	O-RING 3093 O-RING 3093	1
H047	O-RING 2050 O-RING 2050	2
H052	O-RING 106 O-RING 106	2
H053	O-RING 2025 O-RING 2025	1
H054	O-RING 2018 O-RING 2018	1
H057	O-RING 2062 O-RING 2062	2
H059	O-RING 2037 O-RING 2037	4
H061	O-RING 4750 O-RING 4750	2
H062	O-RING 109 "NBR 70" O-RING 109 "NBR 70"	1
H063	O-RING 4081 O-RING 4081	1
H064	O-RING 3043 O-RING 3043	2
H066	O-RING 3118 O-RING 3118	1
H090	O-RING 3056 O-RING 3056	1
H177	O-RING 4131 O-RING 4131	2
H202	O-RING 2043 O-RING 2043	2
H206	O-RING 3043 "VITON" O-RING 3043 "VITON"	1
H207	O-RING 4093 "VITON" O-RING 4093 "VITON"	1
H360	O-RING 3775 O-RING 3775	1
I094	OGIVA STRINGI TUBO CLAMPING TUBE OGIVE	1

Art. KS4483	DESCRIZIONE DESCRIPTION	Q. TÀ QTY
KR4204	TUBO SCARICO CON FASCETTA STRINGI TUBO DISCHARGING HOSE WITH HOSE CLAMP	1
KR4302	TUBO ASPIRAZIONE COMPLETO COMPLETE SUCTION HOSE	1
KR4306	CILINDRO - 2 O-RING - ETICHETTA CYLINDER - 2 O-RING - LABEL	1
KR4403	TUBO FLESSIBILE PER SERBATOIO 90 l CONNECTION HOSE FOR 90 l RESERVOIR	1
KR4451	KIT GUARNIZIONI COMPLETO COMPLETE GASKETS KIT	1
S104	VUOTOMETRO ø 60 mm VACUUM GAUGE ø 60 mm	1

RAASM

FLUIDS AND LUBRICATION EQUIPMENT

GUIDA RICAMBI - SPARE PARTS GUIDE

KIT RICAMBI		
OGNI KIT SOTTO RIPORTATO COMPRENDE I RICAMBI EVIDENZIATI CON LO STESSO COLORE E LE RELATIVE GUARNIZIONI. QUESTI RICAMBI NON SONO FORNIBILI SEPARATAMENTE TRANNE QUELLI CODIFICATI.		
SPARE PARTS KITS		
EACH KIT SHOWN WITH THE SAME COLOR INCLUDES ALSO THE GASKETS. THE SPARE PARTS INCLUDED IN THE KIT CAN'T BE SUPPLIED SEPARATELY EXCEPT THOSE SHOWN WITH A PROPER CODE.		
CODICE CODE	DESCRIZIONE DESCRIPTION	Q.TÀ QTY
KR3202	DUE RUOTE PIROETTANTI CON DADI TWO SWIVELLING WHEELS WITH NUTS	1
KR3203	2 RUOTE FISSE CON ANELLI ELASTICI 2 FIXED WHEELS WITH RETAINING RINGS	1
KR4201	COPPA RACCOGLI OLIO OIL COLLECTING BOWL	1
KR4203	GRUPPO RUBINETTO-VALVOLA DI SICUREZZA AIR TAP AND SAFETY VALVE GROUP	1
KR4206	TUBO LIVELLO CON ETICHETTA GAUGE TUBE WITH LABEL	1
KR4207	IMBUTO CON GRIGLIA FUNNEL WITH NET	1
KR4229	SET DI VITI PER SERBATOIO SET OF SCREWS FOR RESERVOIR	1
KR4302	TUBO ASPIRAZIONE COMPLETO COMPLETE SUCTION HOSE	1
KR4305	GRUPPO ASPIRAZIONE COMPLETO COMPLETE SUCTION GROUP	1
KR4306	CILINDRO - 2 O-RING - ETICHETTA CYLINDER - 2 O-RING - LABEL	1
KR4307	DUE FLANGE PRECAMERA TWO TRANSPARENT BOWL FLANGES	1
KR4308	ACCESSORI PRECAMERA TRANSPARENT BOWL ACCESSORIES	1
KR4401	TUBO SUPPORTO COPPA BOWL SUPPORTING TUBE	1
KR4403	TUBO FLESSIBILE PER SERBATOIO 90 l CONNECTION HOSE FOR 90 l RESERVOIR	1

ELENCO RICAMBI FORNIBILI SINGOLARMENTE		
LIST OF SPARE PARTS WHICH CAN BE SUPPLIED SEPARATELY		
CODICE CODE	DESCRIZIONE DESCRIPTION	Q.TÀ QTY
33118	NIPPLE M 1/2" G x M 3/4" G NIPPLE M 1/2" G x M 3/4" G	1
33127	ATTACCO RAPIDO MASCHIO MALE QUICK CONNECTION	1
45500	RACCORDO PER SONDE (VOLKSWAGEN) CONNECTOR FOR PROBES (VOLKSWAGEN)	1
45501	RACCORDO PER SONDE (BMW) CONNECTOR FOR PROBES (BMW)	1
45502	RACCORDO PER SONDE (CITROEN) CONNECTOR FOR PROBES (CITROEN)	1
45504	SONDA ø 5 x 700 FLESSIBILE PROBE ø 5 x 700 FLEXIBLE	1
45505	SONDA ø 5 x 700 METALLO-MALLEABILE PROBE ø 5 x 700 MALLEABLE METAL	1
45506	SONDA ø 6 x 700 FLESSIBILE PROBE ø 6 x 700 FLEXIBLE	1
45516	SONDA ø 6 x 700 METALLO-MALLEABILE PROBE ø 6 x 700 MALLEABLE METAL	1
45517	SONDA ø 7 x 1000 FLESSIBILE PROBE ø 7 x 1000 FLEXIBLE	1
45518	SONDA ø 8 x 700 FLESSIBILE PROBE ø 8 x 700 FLEXIBLE	1
I108	VASCETTA PORTA OGGETTI TOOL TRAY	1
KC114	MANICO A "U" HANDLE	1
KC226/VERDE	SERBATOIO 90 l RESERVOIR 90 l	1
KC298	GRUPPO SCARICO COPPA DISCHARGING GROUP	1
KC312	GHIERA IRON RING	1
KG001	RUBINETTO UNIVERSALE CARICA ARIA UNIVERSAL AIR TAP	1
KG079	GRUPPO GOMITO E GHIERA RING AND ELBOW JOINT GROUP	2
KG179	CONTENITORE PORTA SONDE PROBES CONTAINER	1
KG180	SILENZIATORE COMPLETO COMPLETE MUFFLER	1
N513	LEVA BLOCCA/PULSANTE PRECAMERA PRECHAMBER LOCKING LEVER	1
S104	VUOTOMETRO ø 60 mm VACUUM GAUGE ø 60 mm	1
S203	RUBINETTO A SFERA 1/2" BALL VALVE 1/2"	1
S211	RUBINETTO A SFERA 1" BALL VALVE 1"	1
S215	RUBINETTO A SFERA 1/4" BALL VALVE 1/4"	1
S402	VALVOLA DI SICUREZZA 1 bar SAFETY VALVE 1 bar	1

Art. KR4451		
KIT GUARNIZIONI COMPLETO		
COMPOSTO DALLE GUARNIZIONI SOTTO ELENCAE		
JOINTS GASKETS LIST		
INCLUDING ALL THE GASKETS SHOWN HERE UNDER		
CODICE CODE	DESCRIZIONE DESCRIPTION	Q.TÀ QTY
H034	O-RING 3156 O-RING 3156	2
H036	O-RING 3093 O-RING 3093	1
H047	O-RING 2050 O-RING 2050	2
H052	O-RING 106 O-RING 106	2
H053	O-RING 2025 O-RING 2025	1
H054	O-RING 2018 O-RING 2018	1
H057	O-RING 2062 O-RING 2062	2
H059	O-RING 2037 O-RING 2037	4
H061	O-RING 4750 O-RING 4750	2
H062	O-RING 109 "NBR 70" O-RING 109 "NBR 70"	1
H063	O-RING 4081 O-RING 4081	1
H064	O-RING 3043 O-RING 3043	2
H066	O-RING 3118 O-RING 3118	1
H090	O-RING 3056 O-RING 3056	1
H177	O-RING 4131 O-RING 4131	2
H202	O-RING 2043 O-RING 2043	2
H206	O-RING 3043 "VITON" O-RING 3043 "VITON"	1
H207	O-RING 4093 "VITON" O-RING 4093 "VITON"	1
H360	O-RING 3775 O-RING 3775	1
I094	OGIVA STRINGI TUBO CLAMPING TUBE OGIVE	1

Art. KS4487		
SET RICAMBI CONSIGLIATI		
AI PUNTI VENDITA E ASSISTENZA,		
COMPOSTO DAI RICAMBI SOTTO ELENCAE		
SPARE PARTS KIT ADVISED		
TO THE REPAIR CENTERS. THIS KIT INCLUDES		
ALL THE SPARE PARTS SHOWN HERE UNDER		
CODICE CODE	DESCRIZIONE DESCRIPTION	Q.TÀ QTY
KR4302	TUBO ASPIRAZIONE COMPLETO COMPLETE SUCTION HOSE	1
KR4306	CILINDRO - 2 O-RING - ETICHETTA CYLINDER - 2 O-RING - LABEL	1
KR4403	TUBO FLESSIBILE PER SERBATOIO 90 l CONNECTION HOSE FOR 90 l RESERVOIR	1
KR4451	KIT GUARNIZIONI COMPLETO COMPLETE GASKETS KIT	1
S104	VUOTOMETRO ø 60 mm VACUUM GAUGE ø 60 mm	1



GUIDA RICAMBI - SPARE PARTS GUIDE

KIT RICAMBI OGNI KIT SOTTO RIPORTATO COMPRENDE I RICAMBI EVIDENZIATI CON LO STESSO COLORE E LE RELATIVE GUARNIZIONI. QUESTI RICAMBI NON SONO FORNIBILI SEPARATAMENTE TRANNE QUELLI CODIFICATI.		
SPARE PARTS KITS EACH KIT SHOWN WITH THE SAME COLOR INCLUDES ALSO THE GASKETS. THE SPARE PARTS INCLUDED IN THE KIT CAN'T BE SUPPLIED SEPARATELY EXCEPT THOSE SHOWN WITH A PROPER CODE.		
CODICE CODE	DESCRIZIONE DESCRIPTION	Q.TÀ QTY
KR3202	DUE RUOTE PIROETTANTI CON DADI TWO SWIVELLING WHEELS WITH NUTS	1
KR3203	2 RUOTE FISSI CON ANELLI ELASTICI 2 FIXED WHEELS WITH RETAINING RINGS	1
KR4201	COPPA RACCOGLI OLIO OIL COLLECTING BOWL	1
KR4205	SET DI VITI PER SERBATOIO SET OF SCREWS FOR RESERVOIR	1
KR4206	TUBO LIVELLO CON ETICHETTA GAUGE TUBE WITH LABEL	1
KR4207	IMBUTO CON GRIGLIA FUNNEL WITH NET	1
KR4230	GR. RUBINETTO CON REG. PRESSIONE AIR TAP GROUP WITH PRESSURE REGULATOR	1
KR4302	TUBO ASPIRAZIONE COMPLETO COMPLETE SUCTION HOSE	1
KR4305	GRUPPO ASPIRAZIONE COMPLETO COMPLETE SUCTION GROUP	1
KR4306	CILINDRO - 2 O-RING - ETICHETTA CYLINDER - 2 O-RING - LABEL	1
KR4307	DUE FLANGE PRECAMERA TWO TRANSPARENT BOWL FLANGES	1
KR4308	ACCESSORI PRECAMERA TRANSPARENT BOWL ACCESSORIES	1
KR4401	TUBO SUPPORTO COPPA BOWL SUPPORTING TUBE	1
KR4403	TUBO FLESSIBILE PER SERBATOIO 90 l CONNECTION HOSE FOR 90 l RESERVOIR	1

ELENCO RICAMBI FORNIBILI SINGOLARMENTE LIST OF SPARE PARTS WHICH CAN BE SUPPLIED SEPARATELY		
CODICE CODE	DESCRIZIONE DESCRIPTION	Q.TÀ QTY
33118	NIPPLE M 1/2" G x M 3/4" G NIPPLE M 1/2" G x M 3/4" G	1
33127	ATTACCO RAPIDO MASCHIO MALE QUICK CONNECTION	1
45500	RACCORDO PER SONDE (VOLKSWAGEN) CONNECTOR FOR PROBES (VOLKSWAGEN)	1
45501	RACCORDO PER SONDE (BMW) CONNECTOR FOR PROBES (BMW)	1
45502	RACCORDO PER SONDE (CITROEN) CONNECTOR FOR PROBES (CITROEN)	1
45504	SONDA ø 5 x 700 FLESSIBILE PROBE ø 5 x 700 FLEXIBLE	1
45505	SONDA ø 5 x 700 METALLO-MALLEABILE PROBE ø 5 x 700 MALLEABLE METAL	1
45506	SONDA ø 6 x 700 FLESSIBILE PROBE ø 6 x 700 FLEXIBLE	1
45516	SONDA ø 6 x 700 METALLO-MALLEABILE PROBE ø 6 x 700 MALLEABLE METAL	1
45517	SONDA ø 7 x 1000 FLESSIBILE PROBE ø 7 x 1000 FLEXIBLE	1
45518	SONDA ø 8 x 700 FLESSIBILE PROBE ø 8 x 700 FLEXIBLE	1
I108	VASCETTA PORTA OGGETTI TOOL TRAY	1
KC114	MANICO A "U" HANDLE	1
KC226/VERDE	SERBATOIO 90 l RESERVOIR 90 l	1
KC298	GRUPPO SCARICO COPPA DISCHARGING GROUP	1
KC312	GHIERA IRON RING	1
KG079	GRUPPO GOMITO E GHIERA RING AND ELBOW JOINT GROUP	2
KG179	CONTENITORE PORTA SONDE PROBES CONTAINER	1
KG180	SILENZIATORE COMPLETO COMPLETE MUFFLER	1
N513	LEVA BLOCCA PULSANTE PRECAMERA PRECHAMBER HOOKING LEVER	1
S101	MANOMETRO ø 60 mm GAUGE ø 60 mm	1
S104	VUOTOMETRO ø 60 mm VACUUM GAUGE ø 60 mm	1
S203	RUBINETTO A SFERA 1/2" BALL VALVE 1/2"	1
S211	RUBINETTO A SFERA 1" BALL VALVE 1"	1
S215	RUBINETTO A SFERA 1/4" BALL VALVE 1/4"	1
S301	REGOLATORE DI PRESSIONE 1/4" PRESSURE REGULATOR 1/4"	1
S402	VALVOLA DI SICUREZZA 1 bar SAFETY VALVE 1 bar	1

Art. KR4451 KIT GUARNIZIONI COMPLETO COMPOSTO DALLE GUARNIZIONI SOTTO ELENCAE JOINTS GASKETS LIST INCLUDING ALL THE GASKETS SHOWN HERE UNDER		
CODICE CODE	DESCRIZIONE DESCRIPTION	Q.TÀ QTY
H034	O-RING 3156 O-RING 3156	2
H036	O-RING 3093 O-RING 3093	1
H047	O-RING 2050 O-RING 2050	2
H052	O-RING 106 O-RING 106	2
H053	O-RING 2025 O-RING 2025	1
H054	O-RING 2018 O-RING 2018	1
H057	O-RING 2062 O-RING 2062	2
H059	O-RING 2037 O-RING 2037	4
H061	O-RING 4750 O-RING 4750	2
H062	O-RING 109 "NBR 70" O-RING 109 "NBR 70"	1
H063	O-RING 4081 O-RING 4081	1
H064	O-RING 3043 O-RING 3043	2
H066	O-RING 3118 O-RING 3118	1
H090	O-RING 3056 O-RING 3056	1
H177	O-RING 4131 O-RING 4131	2
H202	O-RING 2043 O-RING 2043	2
H206	O-RING 3043 "VITON" O-RING 3043 "VITON"	1
H207	O-RING 4093 "VITON" O-RING 4093 "VITON"	1
H360	O-RING 3775 O-RING 3775	1
I094	OGIVA STRINGI TUBO CLAMPING TUBE OGIVE	1

Art. KS4487 SET RICAMBI CONSIGLIATI AI PUNTI VENDITA E ASSISTENZA, COMPOSTO DAI RICAMBI SOTTO ELENCAE SPARE PARTS KIT ADVISED TO THE REPAIR CENTERS. THIS KIT INCLUDES ALL THE SPARE PARTS SHOWN HERE UNDER		
CODICE CODE	DESCRIZIONE DESCRIPTION	Q.TÀ QTY
KR4302	TUBO ASPIRAZIONE COMPLETO COMPLETE SUCTION HOSE	1
KR4306	CILINDRO - 2 O-RING - ETICHETTA CYLINDER - 2 O-RING - LABEL	1
KR4403	TUBO FLESSIBILE PER SERBATOIO 90 l CONNECTION HOSE FOR 90 l RESERVOIR	1
KR4451	KIT GUARNIZIONI COMPLETO COMPLETE GASKETS KIT	1
S104	VUOTOMETRO ø 60 mm VACUUM GAUGE ø 60 mm	1

GUIDA RICAMBI - SPARE PARTS GUIDE

KIT RICAMBI OGNI KIT SOTTO RIPORTATO COMPRENDE I RICAMBI EVIDENZIATI CON LO STESSO COLORE E LE RELATIVE GUARNIZIONI. QUESTI RICAMBI NON SONO FORNIBILI SEPARATAMENTE TRANNE QUELLI CODIFICATI.		
SPARE PARTS KITS EACH KIT SHOWN WITH THE SAME COLOR INCLUDES ALSO THE GASKETS. THE SPARE PARTS INCLUDED IN THE KIT CAN'T BE SUPPLIED SEPARATELY EXCEPT THOSE SHOWN WITH A PROPER CODE.		
CODICE CODE	DESCRIZIONE DESCRIPTION	Q.TÀ QTY
KR3202	DUE RUOTE PIROETTANTI CON DADI TWO SWIVELLING WHEELS WITH NUTS	1
KR4201	COPPA RACCOGLI OLIO OIL COLLECTING BOWL	1
KR4203	GRUPPO RUBINETTO-VALVOLA DI SICUREZZA AIR TAP AND SAFETY VALVE GROUP	1
KR4204	TUBO SCARICO CON FASCETTA STRINGI TUBO DISCHARGING HOSE WITH HOSE CLAMP	1
KR4205	SET DI VITI PER SERBATOIO SET OF SCREWS FOR RESERVOIR	1
KR4207	IMBUTO CON GRIGLIA FUNNEL WITH NET	1
KR4302	TUBO ASPIRAZIONE COMPLETO COMPLETE SUCTION HOSE	1
KR4304	GRUPPO ASPIRAZIONE CON RUBINETTO SUCTION GROUP WITH TAP	1
KR4401	TUBO SUPPORTO COPPA BOWL SUPPORTING TUBE	1
KR4403	TUBO FLESSIBILE PER SERBATOIO 115 l CONNECTION HOSE FOR 115 l RESERVOIR	1
KR4608	TUBO LIVELLO CON ETICHETTA GAUGE TUBE WITH LABEL	1
KR4614	2 RUOTE FISSE CON ANELLI ELASTICI 2 FIXED WHEELS WITH RETAINING RINGS	1

ELENCO RICAMBI FORNIBILI SINGOLARMENTE LIST OF SPARE PARTS WHICH CAN BE SUPPLIED SEPARATELY		
CODICE CODE	DESCRIZIONE DESCRIPTION	Q.TÀ QTY
45500	RACCORDO PER SONDE (VOLKSWAGEN) CONNECTOR FOR PROBES (VOLKSWAGEN)	1
45501	RACCORDO PER SONDE (BMW) CONNECTOR FOR PROBES (BMW)	1
45502	RACCORDO PER SONDE (CITROEN) CONNECTOR FOR PROBES (CITROEN)	1
45504	SONDA ø 5 x 700 FLESSIBILE PROBE ø 5 x 700 FLEXIBLE	1
45505	SONDA ø 5 x 700 METALLO-MALLEABILE PROBE ø 5 x 700 MALLEABLE METAL	1
45506	SONDA ø 6 x 700 FLESSIBILE PROBE ø 6 x 700 FLEXIBLE	1
45516	SONDA ø 6 x 700 METALLO-MALLEABILE PROBE ø 6 x 700 MALLEABLE METAL	1
45517	SONDA ø 7 x 1000 FLESSIBILE PROBE ø 7 x 1000 FLEXIBLE	1
45518	SONDA ø 8 x 700 FLESSIBILE PROBE ø 8 x 700 FLEXIBLE	1
I108	VASCHETTA PORTA OGGETTI TOOL TRAY	1
KC027	MANICO A "U" HANDLE	1
KC032	GRUPPO SCARICO SERBATOIO DISCHARGING GROUP	1
KC256/VERDE	SERBATOIO 115 l RESERVOIR 115 l	1
KC298	GRUPPO SCARICO COPPA DISCHARGING GROUP	1
KC312	GHIERA IRON RING	1
KG001	RUBINETTO UNIVERSALE CARICA ARI UNIVERSAL AIR TAP	1
KG079	GRUPPO GOMITO E GHIERA RING AND ELBOW JOINT GROUP	2
KG179	CONTENITORE PORTA SONDE PROBES CONTAINER	1
KG180	SILENZIATORE COMPLETO COMPLETE MUFFLER	1
S104	VUOTOMETRO ø 60 mm VACUUM GAUGE ø 60 mm	1
S215	RUBINETTO A SFERA 1/4" BALL VALVE 1/4"	1
S402	VALVOLA DI SICUREZZA 1 bar SAFETY VALVE 1 bar	1

Art. KR4450 KIT GUARNIZIONI COMPLETO COMPOSTO DALLE GUARNIZIONI SOTTO ELENCAE JOINTS GASKETS LIST INCLUDING ALL THE GASKETS SHOWN HERE UNDER		
CODICE CODE	DESCRIZIONE DESCRIPTION	Q.TÀ QTY
H034	O-RING 3156 O-RING 3156	1
H047	O-RING 2050 O-RING 2050	2
H052	O-RING 106 O-RING 106	2
H053	O-RING 2025 O-RING 2025	1
H054	O-RING 2018 O-RING 2018	3
H057	O-RING 2062 O-RING 2062	2
H059	O-RING 2037 O-RING 2037	5
H064	O-RING 3043 O-RING 3043	2
H066	O-RING 3118 O-RING 3118	1
H177	O-RING 4131 O-RING 4131	2
H202	O-RING 2043 O-RING 2043	2
H206	O-RING 3043 "VITON" O-RING 3043 "VITON"	1
I094	OGIVA STRINGI TUBO CLAMPING TUBE OGIVE	1

Art. KS4485 SET RICAMBI CONSIGLIATI AI PUNTI VENDITA E ASSISTENZA. COMPOSTO DAI RICAMBI SOTTO ELENCAE SPARE PARTS KIT ADVISED TO THE REPAIR CENTERS. THIS KIT INCLUDES ALL THE SPARE PARTS SHOWN HERE UNDER		
CODICE CODE	DESCRIZIONE DESCRIPTION	Q.TÀ QTY
KR4204	TUBO SCARICO CON FASCETTA STRINGI TUBO DISCHARGING HOSE WITH HOSE CLAMP	1
KR4302	TUBO ASPIRAZIONE COMPLETO COMPLETE SUCTION HOSE	1
KR4403	TUBO FLESSIBILE PER SERBATOIO 115 l CONNECTION HOSE FOR 115 l RESERVOIR	1
KR4450	KIT GUARNIZIONI COMPLETO COMPLETE GASKETS KIT	1
S104	VUOTOMETRO ø 60 mm VACUUM GAUGE ø 60 mm	1

GUIDA RICAMBI - SPARE PARTS GUIDE

KIT RICAMBI		
OGNI KIT SOTTO RIPORTATO COMPRENDE I RICAMBI EVIDENZIATI CON LO STESSO COLORE E LE RELATIVE GUARNIZIONI. QUESTI RICAMBI NON SONO FORNIBILI SEPARATAMENTE TRANNE QUELLI CODIFICATI.		
SPARE PARTS KITS		
EACH KIT SHOWN WITH THE SAME COLOR INCLUDES ALSO THE GASKETS. THE SPARE PARTS INCLUDED IN THE KIT CAN'T BE SUPPLIED SEPARATELY EXCEPT THOSE SHOWN WITH A PROPER CODE.		
CODICE CODE	DESCRIZIONE DESCRIPTION	Q.TÀ QTY
KR3202	DUE RUOTE PIROETTANTI CON DADI TWO SWIVELLING WHEELS WITH NUTS	1
KR4201	COPPA RACCOGLI OLIO OIL COLLECTING BOWL	1
KR4203	GRUPPO RUBINETTO-VALVOLA DI SICUREZZA AIR TAP AND SAFETY VALVE GROUP	1
KR4204	TUBO SCARICO CON FASCETTA STRINGI TUBO DISCHARGING HOSE WITH HOSE CLAMP	1
KR4205	SET DI VITI PER SERBATOIO SET OF SCREWS FOR RESERVOIR	1
KR4207	IMBUTO CON GRIGLIA FUNNEL WITH NET	1
KR4302	TUBO ASPIRAZIONE COMPLETO COMPLETE SUCTION HOSE	1
KR4305	GRUPPO ASPIRAZIONE COMPLETO COMPLETE SUCTION GROUP	1
KR4306	CILINDRO - 2 O-RING - ETICHETTA CYLINDER - 2 O-RING - LABEL	1
KR4307	DUE FLANGE PRECAMERA TWO TRANSPARENT BOWL FLANGES	1
KR4308	ACCESSORI PRECAMERA TRANSPARENT BOWL ACCESSORIES	1
KR4401	TUBO SUPPORTO COPPA BOWL SUPPORTING TUBE	1
KR4403	TUBO FLESSIBILE PER SERBATOIO 115 l CONNECTION HOSE FOR 115 l RESERVOIR	1
KR4608	TUBO LIVELLO CON ETICHETTA GAUGE TUBE WITH LABEL	1
KR4614	2 RUOTE FISSE CON ANELLI ELASTICI 2 FIXED WHEELS WITH RETAINING RINGS	1

ELENCO RICAMBI FORNIBILI SINGOLARMENTE		
LIST OF SPARE PARTS WHICH CAN BE SUPPLIED SEPARATELY		
CODICE CODE	DESCRIZIONE DESCRIPTION	Q.TÀ QTY
45500	RACCORDO PER SONDE (VOLKSWAGEN) CONNECTOR FOR PROBES (VOLKSWAGEN)	1
45501	RACCORDO PER SONDE (BMW) CONNECTOR FOR PROBES (BMW)	1
45502	RACCORDO PER SONDE (CITROEN) CONNECTOR FOR PROBES (CITROEN)	1
45504	SONDA ø 5 x 700 FLESSIBILE PROBE ø 5 x 700 FLEXIBLE	1
45505	SONDA ø 5 x 700 METALLO-MALLEABILE PROBE ø 5 x 700 MALLEABLE METAL	1
45506	SONDA ø 6 x 700 FLESSIBILE PROBE ø 6 x 700 FLEXIBLE	1
45516	SONDA ø 6 x 700 METALLO-MALLEABILE PROBE ø 6 x 700 MALLEABLE METAL	1
45517	SONDA ø 7 x 1000 FLESSIBILE PROBE ø 7 x 1000 FLEXIBLE	1
45518	SONDA ø 8 x 700 FLESSIBILE PROBE ø 8 x 700 FLEXIBLE	1
I108	VASCHETTA PORTA OGGETTI TOOL TRAY	1
KC027	MANICO A "U" HANDLE	1
KC032	GRUPPO SCARICO SERBATOIO DISCHARGING GROUP	1
KC256/VERDE	SERBATOIO 115 l RESERVOIR 115 l	1
KC298	GRUPPO SCARICO COPPA DISCHARGING GROUP	1
KC312	GHIERA IRON RING	1
KG001	RUBINETTO UNIVERSALE CARICA ARI UNIVERSAL AIR TAP	1
KG079	GRUPPO GOMITO E GHIERA RING AND ELBOW JOINT GROUP	2
KG179	CONTENITORE PORTA SONDE PROBES CONTAINER	1
KG180	SILENZIATORE COMPLETO COMPLETE MUFFLER	1
N513	LEVA BLOCCA PULSANTE PRECAMERA PRECHAMBER HOIKING LEVER	1
S104	VUOTOMETRO ø 60 mm VACUUM GAUGE ø 60 mm	1
S211	RUBINETTO A SFERA 1" BALL VALVE 1"	1
S215	RUBINETTO A SFERA 1/4" BALL VALVE 1/4"	1
S402	VALVOLA DI SICUREZZA 1 bar SAFETY VALVE 1 bar	1

Art. KR4451		
KIT GUARNIZIONI COMPLETO		
COMPOSTO DALLE GUARNIZIONI SOTTO ELENcate		
JOINTS GASKETS LIST		
INCLUDING ALL THE GASKETS SHOWN HERE UNDER		
CODICE CODE	DESCRIZIONE DESCRIPTION	Q.TÀ QTY
H034	O-RING 3156 O-RING 3156	2
H036	O-RING 3093 O-RING 3093	1
H047	O-RING 2050 O-RING 2050	2
H052	O-RING 106 O-RING 106	2
H053	O-RING 2025 O-RING 2025	1
H054	O-RING 2018 O-RING 2018	1
H057	O-RING 2062 O-RING 2062	2
H059	O-RING 2037 O-RING 2037	4
H061	O-RING 4750 O-RING 4750	2
H062	O-RING 109 "NBR 70" O-RING 109 "NBR 70"	1
H063	O-RING 4081 O-RING 4081	1
H064	O-RING 3043 O-RING 3043	2
H066	O-RING 3118 O-RING 3118	1
H090	O-RING 3056 O-RING 3056	1
H177	O-RING 4131 O-RING 4131	2
H202	O-RING 2043 O-RING 2043	2
H206	O-RING 3043 "VITON" O-RING 3043 "VITON"	1
H207	O-RING 4093 "VITON" O-RING 4093 "VITON"	1
H360	O-RING 3775 O-RING 3775	1
I094	OGIVA STRINGI TUBO CLAMPING TUBE OGIVE	1

Art. KS4483		
SET RICAMBI CONSIGLIATI		
AI PUNTI VENDITA E ASSISTENZA,		
COMPOSTO DAI RICAMBI SOTTO ELENcati		
SPARE PARTS KIT ADVISED		
TO THE REPAIR CENTERS. THIS KIT INCLUDES		
ALL THE SPARE PARTS SHOWN HERE UNDER		
CODICE CODE	DESCRIZIONE DESCRIPTION	Q.TÀ QTY
KR4204	TUBO SCARICO CON FASCETTA STRINGI TUBO DISCHARGING HOSE WITH HOSE CLAMP	1
KR4302	TUBO ASPIRAZIONE COMPLETO COMPLETE SUCTION HOSE	1
KR4306	CILINDRO - 2 O-RING - ETICHETTA CYLINDER - 2 O-RING - LABEL	1
KR4403	TUBO FLESSIBILE PER SERBATOIO 115 l CONNECTION HOSE FOR 115 l RESERVOIR	1
KR4451	KIT GUARNIZIONI COMPLETO COMPLETE GASKETS KIT	1
S104	VUOTOMETRO ø 60 mm VACUUM GAUGE ø 60 mm	1

GUIDA RICAMBI - SPARE PARTS GUIDE

KIT RICAMBI OGNI KIT SOTTO RIPORTATO COMPRENDE I RICAMBI EVIDENZIATI CON LO STESSO COLORE E LE RELATIVE GUARNIZIONI. QUESTI RICAMBI NON SONO FORNIBILI SEPARATAMENTE TRANNE QUELLI CODIFICATI.		
SPARE PARTS KITS EACH KIT SHOWN WITH THE SAME COLOR INCLUDES ALSO THE GASKETS. THE SPARE PARTS INCLUDED IN THE KIT CAN'T BE SUPPLIED SEPARATELY EXCEPT THOSE SHOWN WITH A PROPER CODE.		
CODICE CODE	DESCRIZIONE DESCRIPTION	Q.TÀ QTY
KR3202	DUE RUOTE PIROETTANTI CON DADI TWO SWIVELLING WHEELS WITH NUTS	1
KR4201	COPPA RACCOGLI OLIO OIL COLLECTING BOWL	1
KR4203	GRUPPO RUBINETTO-VALVOLA DI SICUREZZA AIR TAP AND SAFETY VALVE GROUP	1
KR4205	SET DI VITI PER SERBATOIO SET OF SCREWS FOR RESERVOIR	1
KR4207	IMBUTO CON GRIGLIA FUNNEL WITH NET	1
KR4302	TUBO ASPIRAZIONE COMPLETO COMPLETE SUCTION HOSE	1
KR4305	GRUPPO ASPIRAZIONE COMPLETO COMPLETE SUCTION GROUP	1
KR4306	CILINDRO - 2 O-RING - ETICHETTA CYLINDER - 2 O-RING - LABEL	1
KR4307	DUE FLANGE PRECAMERA TWO TRANSPARENT BOWL FLANGES	1
KR4308	ACCESSORI PRECAMERA TRANSPARENT BOWL ACCESSORIES	1
KR4401	TUBO SUPPORTO COPPA BOWL SUPPORTING TUBE	1
KR4403	TUBO FLESSIBILE PER SERBATOIO 115 l CONNECTION HOSE FOR 115 l RESERVOIR	1
KR4608	TUBO LIVELLO CON ETICHETTA GAUGE TUBE WITH LABEL	1
KR4614	2 RUOTE FISSE CON ANELLI ELASTICI 2 FIXED WHEELS WITH RETAINING RINGS	1

ELENCO RICAMBI FORNIBILI SINGOLARMENTE LIST OF SPARE PARTS WHICH CAN BE SUPPLIED SEPARATELY		
CODICE CODE	DESCRIZIONE DESCRIPTION	Q.TÀ QTY
33118	NIPPLE M 1/2" G x M 3/4" G NIPPLE M 1/2" G x M 3/4" G	1
33127	ATTACCO RAPIDO MASCHIO MALE QUICK CONNECTION	1
45500	RACCORDO PER SONDE (VOLKSWAGEN) CONNECTOR FOR PROBES (VOLKSWAGEN)	1
45501	RACCORDO PER SONDE (BMW) CONNECTOR FOR PROBES (BMW)	1
45502	RACCORDO PER SONDE (CITROEN) CONNECTOR FOR PROBES (CITROEN)	1
45504	SONDA ø 5 x 700 FLESSIBILE PROBE ø 5 x 700 FLEXIBLE	1
45505	SONDA ø 5 x 700 METALLO-MALLEABILE PROBE ø 5 x 700 MALLEABLE METAL	1
45506	SONDA ø 6 x 700 FLESSIBILE PROBE ø 6 x 700 FLEXIBLE	1
45516	SONDA ø 6 x 700 METALLO-MALLEABILE PROBE ø 6 x 700 MALLEABLE METAL	1
45517	SONDA ø 7 x 1000 FLESSIBILE PROBE ø 7 x 1000 FLEXIBLE	1
45518	SONDA ø 8 x 700 FLESSIBILE PROBE ø 8 x 700 FLEXIBLE	1
I108	VASCETTA PORTA OGGETTI TOOL TRAY	1
KC027	MANICO A "U" HANDLE	1
KC256/VERDE	SERBATOIO 115 l RESERVOIR 115 l	1
KC298	GRUPPO SCARICO COPPA DISCHARGING GROUP	1
KC312	GHERA IRON RING	1
KG001	RUBINETTO UNIVERSALE CARICA ARIA UNIVERSAL AIR TAP	1
KG079	GRUPPO GOMITO E GHERA RING AND ELBOW JOINT GROUP	2
KG179	CONTENITORE PORTA SONDE PROBES CONTAINER	1
KG180	SILENZIATORE COMPLETO COMPLETE MUFFLER	1
N513	LEVA BLOCCA-PULSANTE PRECAMERA PRECHAMBER TROKING LEVER	1
S104	VUOTOMETRO ø 60 mm VACUUM GAUGE ø 60 mm	1
S203	RUBINETTO A SFERA 1/2" BALL VALVE 1/2"	1
S211	RUBINETTO A SFERA 1" BALL VALVE 1"	1
S215	RUBINETTO A SFERA 1/4" BALL VALVE 1/4"	1
S402	VALVOLA DI SICUREZZA 1 bar SAFETY VALVE 1 bar	1

Art. KR4451 KIT GUARNIZIONI COMPLETO COMPOSTO DALLE GUARNIZIONI SOTTO ELENCAE JOINTS GASKETS LIST INCLUDING ALL THE GASKETS SHOWN HERE UNDER		
CODICE CODE	DESCRIZIONE DESCRIPTION	Q.TÀ QTY
H034	O-RING 3156 O-RING 3156	2
H036	O-RING 3093 O-RING 3093	1
H047	O-RING 2050 O-RING 2050	2
H052	O-RING 106 O-RING 106	2
H053	O-RING 2025 O-RING 2025	1
H054	O-RING 2018 O-RING 2018	1
H057	O-RING 2062 O-RING 2062	2
H059	O-RING 2037 O-RING 2037	4
H061	O-RING 4750 O-RING 4750	2
H062	O-RING 109 "NBR 70" O-RING 109 "NBR 70"	1
H063	O-RING 4081 O-RING 4081	1
H064	O-RING 3043 O-RING 3043	2
H066	O-RING 3118 O-RING 3118	1
H090	O-RING 3056 O-RING 3056	1
H177	O-RING 4131 O-RING 4131	2
H202	O-RING 2043 O-RING 2043	2
H206	O-RING 3043 "VITON" O-RING 3043 "VITON"	1
H207	O-RING 4093 "VITON" O-RING 4093 "VITON"	1
H360	O-RING 3775 O-RING 3775	1
I094	OGIVA STRINGI TUBO CLAMPING TUBE OGIVE	1

Art. KS4487 SET RICAMBI CONSIGLIATI AI PUNTI VENDITA E ASSISTENZA, COMPOSTO DAI RICAMBI SOTTO ELENCATI SPARE PARTS KIT ADVISED TO THE REPAIR CENTERS. THIS KIT INCLUDES ALL THE SPARE PARTS SHOWN HERE UNDER		
CODICE CODE	DESCRIZIONE DESCRIPTION	Q.TÀ QTY
KR4302	TUBO ASPIRAZIONE COMPLETO COMPLETE SUCTION HOSE	1
KR4306	CILINDRO - 2 O-RING - ETICHETTA CYLINDER - 2 O-RING - LABEL	1
KR4403	TUBO FLESSIBILE PER SERBATOIO 115 l CONNECTION HOSE FOR 115 l RESERVOIR	1
KR4451	KIT GUARNIZIONI COMPLETO COMPLETE GASKETS KIT	1
S104	VUOTOMETRO ø 60 mm VACUUM GAUGE ø 60 mm	1



Art. 44118 Mod. R/AO.C. 115L



VISTA ESPLOSA - EXPLODED VIEW

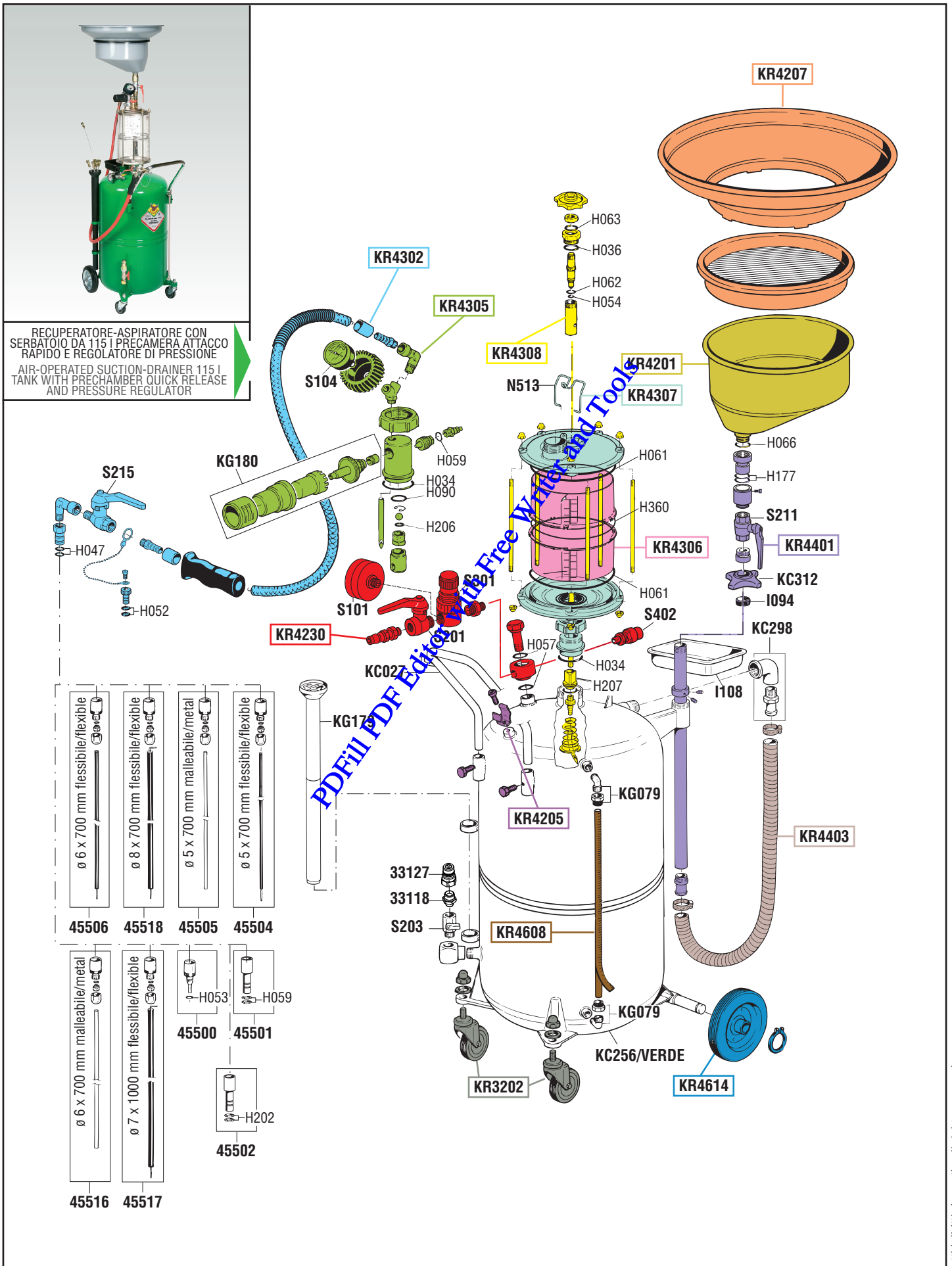

tutti i diritti riservati - all rights reserved

GUIDA RICAMBI - SPARE PARTS GUIDE

KIT RICAMBI OGNI KIT SOTTO RIPORTATO COMPRENDE I RICAMBI EVIDENZIATI CON LO STESSO COLORE E LE RELATIVE GUARNIZIONI. QUESTI RICAMBI NON SONO FORNIBILI SEPARATAMENTE TRANNE QUELLI CODIFICATI.		
SPARE PARTS KITS EACH KIT SHOWN WITH THE SAME COLOR INCLUDES ALSO THE GASKETS. THE SPARE PARTS INCLUDED IN THE KIT CAN'T BE SUPPLIED SEPARATELY EXCEPT THOSE SHOWN WITH A PROPER CODE.		
CODICE CODE	DESCRIZIONE DESCRIPTION	Q.TÀ QTY
KR3202	DUE RUOTE PIROETTANTI CON DADI TWO SWIVELLING WHEELS WITH NUTS	1
KR4201	COPPA RACCOGLI OLIO OIL COLLECTING BOWL	1
KR4205	SET DI VITI PER SERBATOIO SET OF SCREWS FOR RESERVOIR	1
KR4207	IMBUTO CON GRIGLIA FUNNEL WITH NET	1
KR4230	GR. RUBINETTO CON REG. PRESSIONE AIR TAP GROUP WITH PRESSURE REGULATOR	1
KR4302	TUBO ASPIRAZIONE COMPLETO COMPLETE SUCTION HOSE	1
KR4305	GRUPPO ASPIRAZIONE COMPLETO COMPLETE SUCTION GROUP	1
KR4306	CILINDRO - 2 O-RING - ETICHETTA CYLINDER - 2 O-RING - LABEL	1
KR4307	DUE FLANGE PRECAMERA TWO TRANSPARENT BOWL FLANGES	1
KR4308	ACCESSORI PRECAMERA TRANSPARENT BOWL ACCESSORIES	1
KR4401	TUBO SUPPORTO COPPA BOWL SUPPORTING TUBE	1
KR4403	TUBO FLESSIBILE PER SERBATOIO 115 l CONNECTION HOSE FOR 115 l RESERVOIR	1
KR4608	TUBO LIVELLO CON ETICHETTA GAUGE TUBE WITH LABEL	1
KR4614	2 RUOTE FISSE CON ANELLI ELASTICI 2 FIXED WHEELS WITH RETAINING RINGS	1

ELENCO RICAMBI FORNIBILI SINGOLARMENTE LIST OF SPARE PARTS WHICH CAN BE SUPPLIED SEPARATELY		
CODICE CODE	DESCRIZIONE DESCRIPTION	Q.TÀ QTY
33118	NIPPLE M 1/2" G x M 3/4" G NIPPLE M 1/2" G x M 3/4" G	1
33127	ATTACCO RAPIDO MASCHIO MALE QUICK CONNECTION	1
45500	RACCORDO PER SONDE (VOLKSWAGEN) CONNECTOR FOR PROBES (VOLKSWAGEN)	1
45501	RACCORDO PER SONDE (BMW) CONNECTOR FOR PROBES (BMW)	1
45502	RACCORDO PER SONDE (CITROEN) CONNECTOR FOR PROBES (CITROEN)	1
45504	SONDA ø 5 x 700 FLESSIBILE PROBE ø 5 x 700 FLEXIBLE	1
45505	SONDA ø 5 x 700 METALLO-MALLEABILE PROBE ø 5 x 700 MALLEABLE METAL	1
45506	SONDA ø 6 x 700 FLESSIBILE PROBE ø 6 x 700 FLEXIBLE	1
45516	SONDA ø 6 x 700 METALLO-MALLEABILE PROBE ø 6 x 700 MALLEABLE METAL	1
45517	SONDA ø 7 x 1000 FLESSIBILE PROBE ø 7 x 1000 FLEXIBLE	1
45518	SONDA ø 8 x 700 FLESSIBILE PROBE ø 8 x 700 FLEXIBLE	1
I108	VASCETTA PORTA OGGETTI TOOL TRAY	1
KC027	MANICO A "U" HANDLE	1
KC256/VERDE	SERBATOIO 115 l RESERVOIR 115 l	1
KC298	GRUPPO SCARICO COPPA DISCHARGING GROUP	1
KC312	GHERA IRON RING	1
KG079	GRUPPO GOMITO E GHERA RING AND ELBOW JOINT GROUP	2
KG179	CONTENITORE PORTA SONDE PROBES CONTAINER	1
KG180	SILENZIATORE COMPLETO COMPLETE MUFFLER	1
N513	LEVA BLOCCA PULSANTE PRECAMERA PRECHAMBER HOOKING LEVER	1
S101	MANOMETRO ø 60 mm GAUGE ø 60 mm	1
S104	VUOTOMETRO ø 60 mm VACUUM GAUGE ø 60 mm	1
S203	RUBINETTO A SFERA 1/2" BALL VALVE 1/2"	1
S211	RUBINETTO A SFERA 1" BALL VALVE 1"	1
S215	RUBINETTO A SFERA 1/4" BALL VALVE 1/4"	1
S301	REGOLATORE DI PRESSIONE 1/4" PRESSURE REGULATOR 1/4"	1
S402	VALVOLA DI SICUREZZA 1 bar SAFETY VALVE 1 bar	1

Art. KR4451 KIT GUARNIZIONI COMPLETO COMPOSTO DALLE GUARNIZIONI SOTTO ELENcate JOINTS GASKETS LIST INCLUDING ALL THE GASKETS SHOWN HERE UNDER		
CODICE CODE	DESCRIZIONE DESCRIPTION	Q.TÀ QTY
H034	O-RING 3156 O-RING 3156	2
H036	O-RING 3093 O-RING 3093	1
H047	O-RING 2050 O-RING 2050	2
H052	O-RING 106 O-RING 106	2
H053	O-RING 2025 O-RING 2025	1
H054	O-RING 2018 O-RING 2018	1
H057	O-RING 2062 O-RING 2062	2
H059	O-RING 2037 O-RING 2037	4
H061	O-RING 4750 O-RING 4750	2
H062	O-RING 109 "NBR 70" O-RING 109 "NBR 70"	1
H063	O-RING 4081 O-RING 4081	1
H064	O-RING 3043 O-RING 3043	2
H066	O-RING 3118 O-RING 3118	1
H090	O-RING 3056 O-RING 3056	1
H177	O-RING 4131 O-RING 4131	2
H202	O-RING 2043 O-RING 2043	2
H206	O-RING 3043 "VITON" O-RING 3043 "VITON"	1
H207	O-RING 4093 "VITON" O-RING 4093 "VITON"	1
H360	O-RING 3775 O-RING 3775	1
I094	OGIVA STRINGI TUBO CLAMPING TUBE OGIVE	1

Art. KS4487 SET RICAMBI CONSIGLIATI AI PUNTI VENDITA E ASSISTENZA, COMPOSTO DAI RICAMBI SOTTO ELENcati SPARE PARTS KIT ADVISED TO THE REPAIR CENTERS. THIS KIT INCLUDES ALL THE SPARE PARTS SHOWN HERE UNDER		
CODICE CODE	DESCRIZIONE DESCRIPTION	Q.TÀ QTY
KR4302	TUBO ASPIRAZIONE COMPLETO COMPLETE SUCTION HOSE	1
KR4306	CILINDRO - 2 O-RING - ETICHETTA CYLINDER - 2 O-RING - LABEL	1
KR4403	TUBO FLESSIBILE PER SERBATOIO 115 l CONNECTION HOSE FOR 115 l RESERVOIR	1
KR4451	KIT GUARNIZIONI COMPLETO COMPLETE GASKETS KIT	1
S104	VUOTOMETRO ø 60 mm VACUUM GAUGE ø 60 mm	1



Art. 45100



VISTA ESPLOSA - EXPLODED VIEW

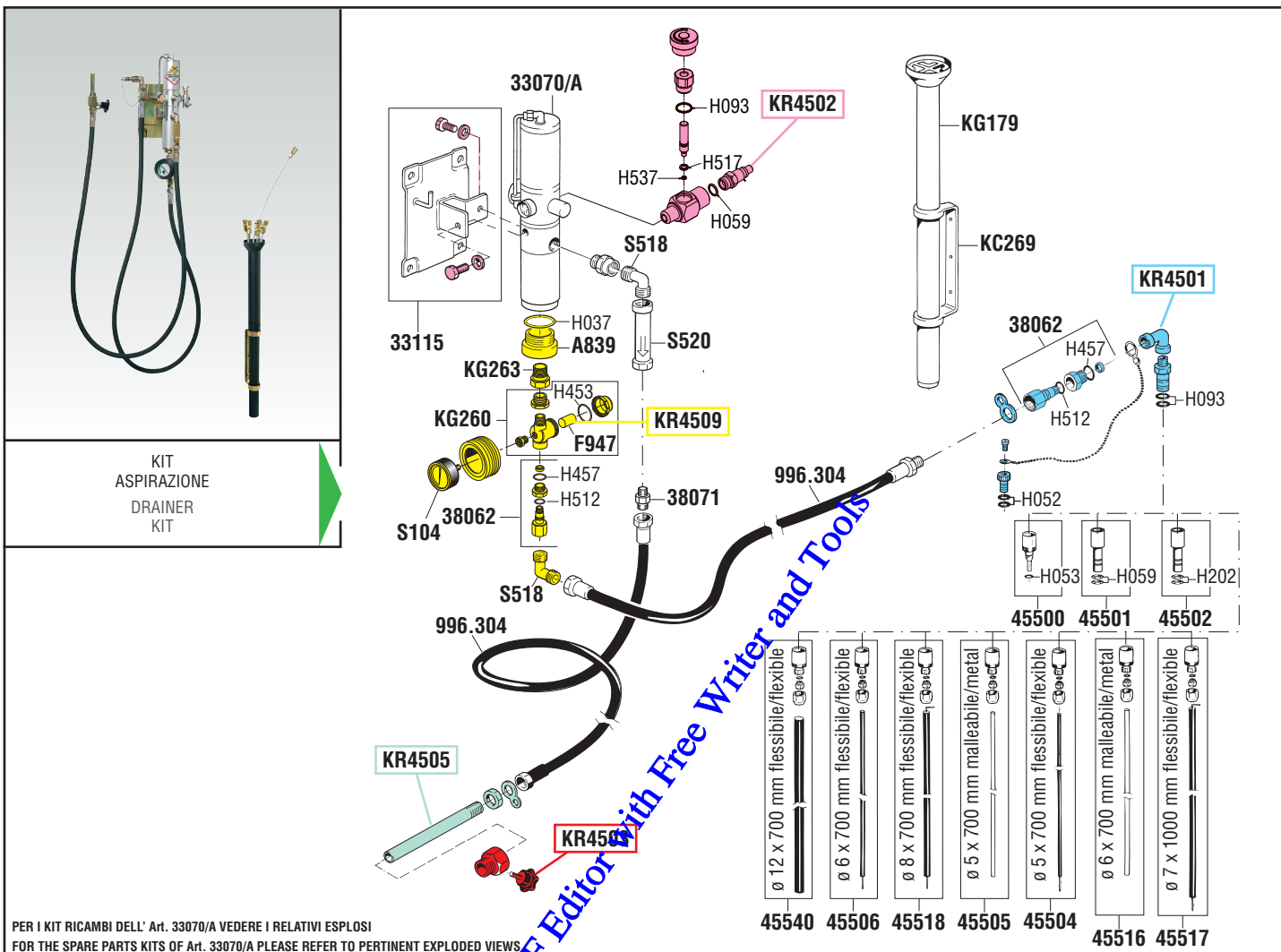

PER I KIT RICAMBI DELL' Art. 33070/A VEDERE I RELATIVI ESPLOSI
FOR THE SPARE PARTS KITS OF Art. 33070/A PLEASE REFER TO PERTINENT EXPLODED VIEWS

tutti i diritti riservati - all rights reserved

GUIDA RICAMBI - SPARE PARTS GUIDE

KIT RICAMBI
OGNI KIT SOTTO RIPORTATO COMPRENDE I RICAMBI EVIDENZIATI CON LO STESSO COLORE E LE RELATIVE GUARNIZIONI. QUESTI RICAMBI NON SONO FORNIBILI SEPARATAMENTE TRANNNE QUELLI CODIFICATI.

SPARE PARTS KITS
EACH KIT SHOWN WITH THE SAME COLOR INCLUDES ALSO THE GASKETS. THE SPARE PARTS INCLUDED IN THE KIT CAN'T BE SUPPLIED SEPARATELY EXCEPT THOSE SHOWN WITH A PROPER CODE.

CODICE CODE	DESCRIZIONE DESCRIPTION	Q.TÀ QTY
KR4501	TERMINALE TUBO ASPIRAZIONE COMPLETO COMPLETE HOSE TRAILING	1
KR4502	REGOLATORE DI FLUSSO ARIA AIR FLOW REGULATING VALVE	1
KR4503	GHIRA FUSTO BUNG ADAPTOR	1
KR4505	TERMINALE SCARICO DISCHARGING HOSE TRAILING	1
KR4509	GRUPPO FILTRO CON VUOTOMETRO FILTER GROUP WITH VACUUM GAUGE	1

ELENCO RICAMBI FORNIBILI SINGOLARMENTE
LIST OF SPARE PARTS WHICH CAN BE SUPPLIED SEPARATELY

CODICE CODE	DESCRIZIONE DESCRIPTION	Q.TÀ QTY
33070/A	POMPA DA TRAVASO R 1:1 TRANSFER PUMP R 1:1	1
33115	STAFFA MURALE WALL BRACKET	1
38062	SNODO GIREVOLE SWIVEL JOINT	1
38071	NIPPLE M 1/2" G x M 1/2" G NIPPLE M 1/2" G x M 1/2" G	2
45500	RACCORDO PER SONDE (VOLKSWAGEN) CONNECTOR FOR PROBES (VOLKSWAGEN)	1
45501	RACCORDO PER SONDE (BMW) CONNECTOR FOR PROBES (BMW)	1

ELENCO RICAMBI FORNIBILI SINGOLARMENTE
LIST OF SPARE PARTS WHICH CAN BE SUPPLIED SEPARATELY

CODICE CODE	DESCRIZIONE DESCRIPTION	Q.TÀ QTY
45502	RACCORDO PER SONDE (CITROEN) CONNECTOR FOR PROBES (CITROEN)	1
45504	SONDA ø 5 x 700 FLESSIBILE PROBE ø 5 x 700 FLEXIBLE	1
45505	SONDA ø 5 x 700 METALLO-MALLEABILE PROBE ø 5 x 700 MALLEABLE METAL	1
45506	SONDA ø 6 x 700 FLESSIBILE PROBE ø 6 x 700 FLEXIBLE	1
45516	SONDA ø 6 x 700 METALLO-MALLEABILE PROBE ø 6 x 700 MALLEABLE METAL	1
45517	SONDA ø 7 x 700 FLESSIBILE PROBE ø 7 x 700 FLEXIBLE	1
45518	SONDA ø 8 x 700 FLESSIBILE PROBE ø 8 x 700 FLEXIBLE	1
45540	SONDA ø 12 x 700 FLESSIBILE PROBE ø 12 x 700 FLEXIBLE	1
996.304	TUBO 1/2" - 4 m - 150 bar HOSE 1/2" - 4 m - 150 bar	2
A839	RACCORDO CONNECTION	1
KC269	STAFFA PORTA SONDE MURALE PROBES CONTAINER BRACKET	1
F947	CARTUCCIA FILTRO FILTER CARTRIDGE	1
KG179	CONTENITORE PORTA SONDE PROBES CONTAINER	1
KG260	FILTRO 1/2" FILTER 1/2"	1
KG263	CODOLO E DADO TANG AND NUT	1
S104	VUOTOMETRO ø 60 mm VACUUM GAUGE ø 60 mm	1
S518	GOMITO M/M 1/2" G ELBOW M/M 1/2" G	2
S520	VALVOLA UNIDIREZIONALE VALVE	1

Art. KR4550 KIT GUARNIZIONI COMPLETO
COMPOSTO DALLE GUARNIZIONI SOTTO ELENCAE JOINTS GASKETS LIST INCLUDING ALL THE GASKETS SHOWN HERE UNDER

CODICE CODE	DESCRIZIONE DESCRIPTION	Q.TÀ QTY
H037	O-RING 3137	1
H052	O-RING 106	2
H053	O-RING 2025	1
H054	O-RING 2018	2
H055	O-RING 2010	1
H059	O-RING 2037	3
H093	O-RING 2050 "VITON"	3
H202	O-RING 2043	2
H453	O-RING 2125 "VITON"	1
H457	O-RING 123 "VITON"	1
H512	O-RING 2050 "VITON 90SH"	1
H517	O-RING 2018 "VITON"	1
H537	O-RING "NBR"	1

Art. KS4580 SET RICAMBI CONSIGLIATI
AI PUNTI VENDITA E ASSISTENZA, COMPOSTO DAI RICAMBI SOTTO ELENCAE
SPARE PARTS KIT ADVISED
TO THE REPAIR CENTERS. THIS KIT INCLUDES ALL THE SPARE PARTS SHOWN HERE UNDER

CODICE CODE	DESCRIZIONE DESCRIPTION	Q.TÀ QTY
KR4550	KIT GUARNIZIONI COMPLETO COMPLETE GASKETS KIT	1
KS3383	POMPE Art. 33070 PUMPS Art. 33070	1



Art. 45110 - Art. 45111



VISTA ESPLOSA - EXPLODED VIEW

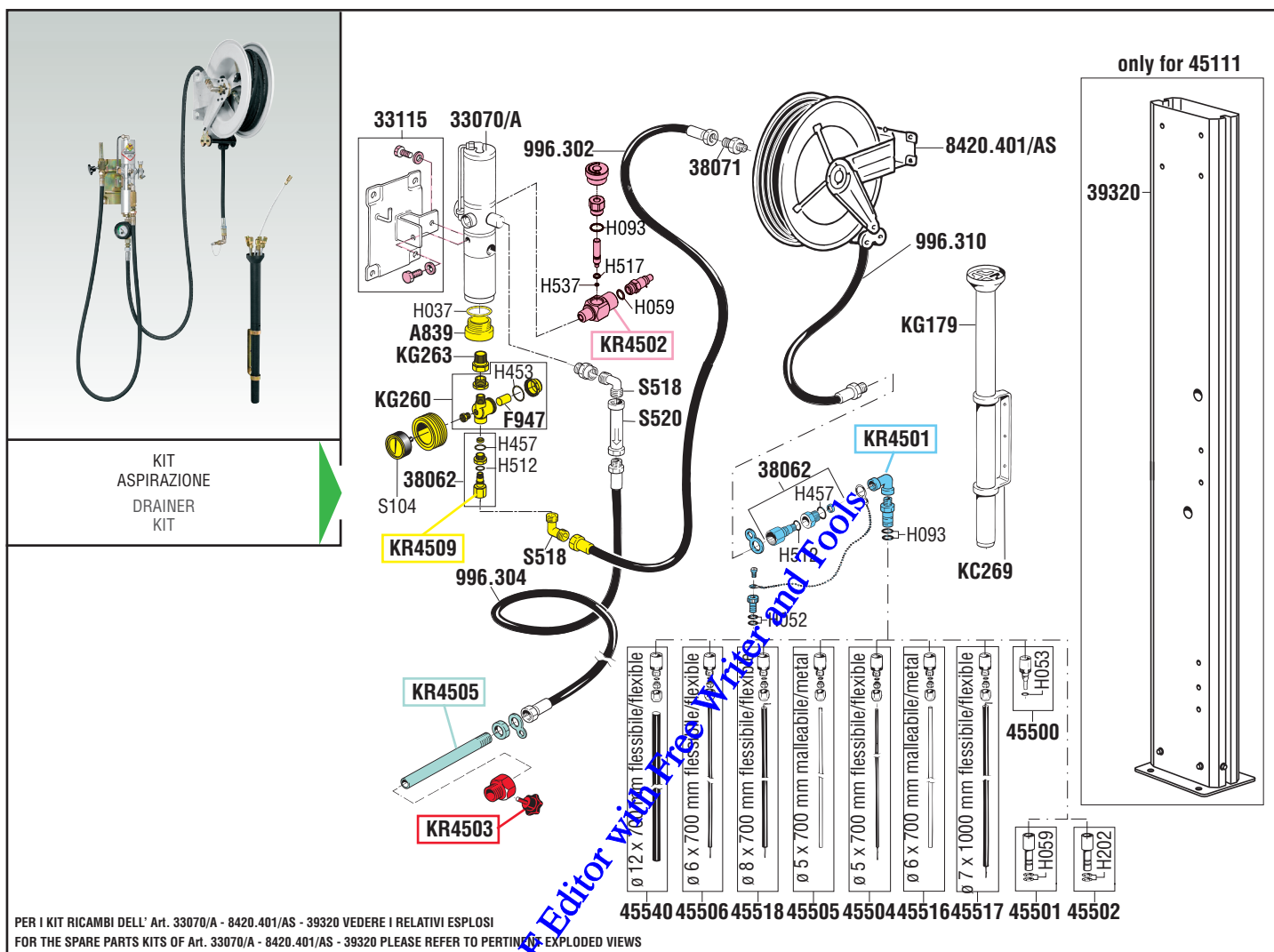

PER I KIT RICAMBI DELL' Art. 33070/A - 8420.401/AS - 39320 VEDERE I RELATIVI ESPLOSI
FOR THE SPARE PARTS KITS OF Art. 33070/A - 8420.401/AS - 39320 PLEASE REFER TO PERTINENT EXPLODED VIEWS

tutti i diritti riservati - all rights reserved

GUIDA RICAMBI - SPARE PARTS GUIDE

KIT RICAMBI
OGNI KIT SOTTO RIPORTATO COMPRENDE I RICAMBI EVIDENZIATI CON LO STESSO COLORE E LE RELATIVE GUARNIZIONI. QUESTI RICAMBI NON SONO FORNIBILI SEPARATAMENTE TRANNE QUELLI CODIFICATI.
SPARE PARTS KITS
EACH KIT SHOWN WITH THE SAME COLOR INCLUDES ALSO THE GASKETS. THE SPARE PARTS INCLUDED IN THE KIT CAN'T BE SUPPLIED SEPARATELY EXCEPT THOSE SHOWN WITH A PROPER CODE.

CODICE CODE	DESCRIZIONE DESCRIPTION	Q.TÀ QTY
KR4501	TERMINALE TUBO ASPIRAZIONE COMPLETO COMPLETE HOSE TRAILING	1
KR4502	REGOLATORE DI FLUSSO ARIA AIR FLOW REGULATING VALVE	1
KR4503	GHIERA FUSTO BUNG ADAPTOR	1
KR4505	TERMINALE SCARICO DISCHARGING HOSE TRAILING	1
KR4509	GRUPPO FILTRO CON VUOTOMETRO FILTER GROUP WITH VACUUM GAUGE	1

ELENCO RICAMBI FORNIBILI SINGOLARMENTE
LIST OF SPARE PARTS WHICH CAN BE SUPPLIED SEPARATELY

CODICE CODE	DESCRIZIONE DESCRIPTION	Q.TÀ QTY
33070/A	POMPA DA TRAVASO R 1:1 TRANSFER PUMP R 1:1	1
33115	STAFFA MURALE WALL BRACKET	1
38062	SNODO GIREVOLE SWIVEL JOINT	1
38071	NIPPLE M 1/2" G x M 1/2" G NIPPLE M 1/2" G x M 1/2" G	2
39320	COLONNA DI SERVIZIO FRONTALE SINGLE POST SERVICE COLUMN	2
45500	RACCORDO PER SONDE (VOLKSWAGEN) CONNECTOR FOR PROBES (VOLKSWAGEN)	1
45501	RACCORDO PER SONDE (BMW) CONNECTOR FOR PROBES (BMW)	1

ELENCO RICAMBI FORNIBILI SINGOLARMENTE
LIST OF SPARE PARTS WHICH CAN BE SUPPLIED SEPARATELY

CODICE CODE	DESCRIZIONE DESCRIPTION	Q.TÀ QTY
45502	RACCORDO PER SONDE (CITROEN) CONNECTOR FOR PROBES (CITROEN)	1
45504	SONDA Ø 5 x 700 FLESSIBILE PROBE Ø 5 x 700 FLEXIBLE	1
45505	SONDA Ø 5 x 700 METALLO-MALLEABILE PROBE Ø 5 x 700 METAL MALLEABLE	1
45506	SONDA Ø 6 x 700 FLESSIBILE PROBE Ø 6 x 700 FLEXIBLE	1
45516	SONDA Ø 6 x 700 METALLO-MALLEABILE PROBE Ø 6 x 700 METAL MALLEABLE	1
45517	SONDA Ø 7 x 700 FLESSIBILE PROBE Ø 7 x 700 FLEXIBLE	1
45518	SONDA Ø 8 x 700 FLESSIBILE PROBE Ø 8 x 700 FLEXIBLE	1
45540	SONDA Ø 12 x 700 FLESSIBILE PROBE Ø 12 x 700 FLEXIBLE	1
8420.401/AS	AVVOLGITUBO PER ASPIRAZIONE SUCTION HOSE REEL	1
996.302	TUBO 1/2" - 2 m - 150 bar HOSE 1/2" - 2 m - 150 bar	1
996.304	TUBO 1/2" - 4 m - 150 bar HOSE 1/2" - 4 m - 150 bar	1
996.310	TUBO 1/2" - 10 m - 150 bar HOSE 1/2" - 10 m - 150 bar	1
A839	RACCORDO CONNECTION	1
F947	CARTUCCIA FILTRO FILTER CARTRIDGE	1
KC269	STAFFA PORTA SONDE MURALE PROBES CONTAINER BRACKET	1
KG179	CONTENITORE PORTA SONDE PROBES CONTAINER	1
KG260	FILTRO 1/2" FILTER 1/2"	1
KG263	CODOLO E DADO TANG AND NUT	1
S104	VUOTOMETRO Ø 60 mm VACUUM GAUGE Ø 60 mm	1
S518	GOMITO M/M 1/2" G ELBOW M/M 1/2" G	1
S520	VALVOLA UNIDIREZIONALE VALVE	1

Art. KR4550 KIT GUARNIZIONI COMPLETO
COMPOSTO DALLE GUARNIZIONI SOTTO ELENCAE JOINTS GASKETS LIST INCLUDING ALL THE GASKETS SHOWN HERE UNDER

CODICE CODE	DESCRIZIONE DESCRIPTION	Q.TÀ QTY
H037	O-RING 3137	1
H052	O-RING 106	2
H053	O-RING 2025	1
H054	O-RING 2018	2
H055	O-RING 2010	1
H059	O-RING 2037	3
H093	O-RING 2050 "VITON"	3
H202	O-RING 2043	2
H453	O-RING 2125 "VITON"	1
H457	O-RING 123 "VITON"	1
H512	O-RING 2050 "VITON 90SH"	1
H517	O-RING 2018 "VITON"	1
H537	O-RING "NBR"	1

Art. KS4581 SET RICAMBI CONSIGLIATI
AI PUNTI VENDITA E ASSISTENZA, COMPOSTO DAI RICAMBI SOTTO ELENCAE TO THE REPAIR CENTERS. THIS KIT INCLUDES ALL THE SPARE PARTS SHOWN HERE UNDER

CODICE/ CODE	DESCRIZIONE/ DESCRIPTION	Q.TÀ/ QTY
KG197	SNODO PER KIT ASPIRAZIONE DRAINING KIT JOINT	1
KR4550	KIT GUARNIZIONI COMPLETO COMPLETE GASKETS KIT	1
KS3383	POMPE Art. 33070 PUMPS Art. 33070	1



Art. 45150

VISTA ESPLOSA - EXPLODED VIEW

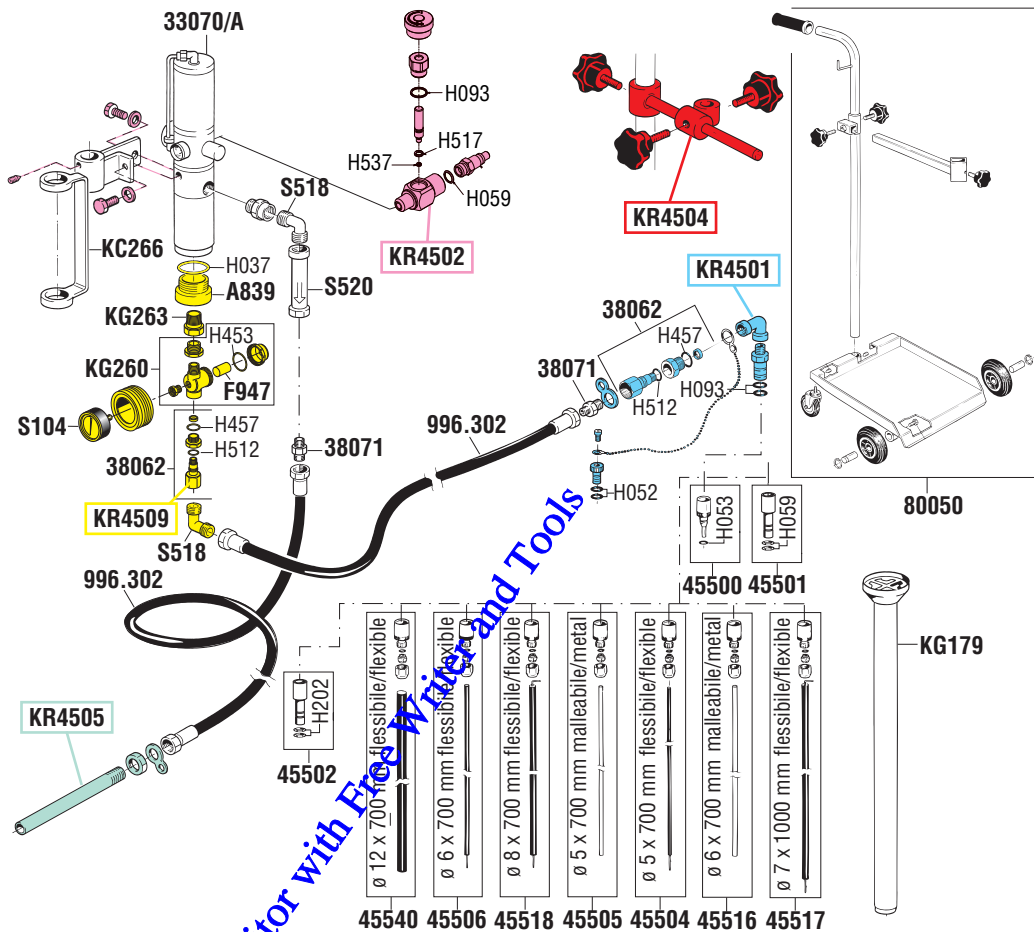

ASPIRATORE-EROGATORE CARRELLATO CON POMPA PNEUMATICA PER FUSTI DA 30 - 60 Kg
DRAINER-DISPENSER WITH AIR PUMP AND WHEEL-MOUNTED FOR 30 - 60 Kg

PER I KIT RICAMBI DELL' Art. 33070/A - 80050 VEDERE I RELATIVI ESPLOSI
FOR THE SPARE PARTS KITS OF Art. 33070/A - 80050 PLEASE REFER TO PERTINENT EXPLODED VIEWS

GUIDA RICAMBI - SPARE PARTS GUIDE

KIT RICAMBI
OGNI KIT SOTTO RIPORTATO COMPRENDE I RICAMBI EVIDENZIATI CON LO STESSO COLORE E LE RELATIVE GUARNIZIONI. QUESTI RICAMBI NON SONO FORNIBILI SEPARATAMENTE TRANNNE QUELLI CODIFICATI.

SPARE PARTS KITS
EACH KIT SHOWN WITH THE SAME COLOR INCLUDES ALSO THE GASKETS. THE SPARE PARTS INCLUDED IN THE KIT CAN'T BE SUPPLIED SEPARATELY EXCEPT THOSE SHOWN WITH A PROPER CODE.

CODICE CODE	DESCRIZIONE DESCRIPTION	Q.TÀ QTY
KR4501	TERMINALE TUBO ASPIRAZIONE COMPLETO COMPLETE HOSE TRAILING	1
KR4502	REGOLATORE DI FLUSSO ARIA AIR FLOW REGULATING VALVE	1
KR4504	SUPPORTO TERMINALE SCARICO DISCHARGING HOSE SUPPORT	1
KR4505	TERMINALE SCARICO DISCHARGING HOSE TRAILING	1
KR4509	GRUPPO FILTRO CON VUOTOMETRO FILTER GROUP WITH VACUUM GAUGE	1

ELENCO RICAMBI FORNIBILI SINGOLARMENTE
LIST OF SPARE PARTS WHICH CAN BE SUPPLIED SEPARATELY

CODICE CODE	DESCRIZIONE DESCRIPTION	Q.TÀ QTY
33070/A	POMPA DA TRAVASO R 1:1 TRANSFER PUMP R 1:1	1
38062	SNODO GIREVOLE SWIVEL JOINT	1
38071	NIPPLE M 1/2" G x M 1/2" G NIPPLE M 1/2" G x M 1/2" G	2
45500	RACCORDO PER SONDE (VOLKSWAGEN) CONNECTOR FOR PROBES (VOLKSWAGEN)	1
45501	RACCORDO PER SONDE (BMW) CONNECTOR FOR PROBES (BMW)	1
45502	RACCORDO PER SONDE (CITROEN) CONNECTOR FOR PROBES (CITROEN)	1

ELENCO RICAMBI FORNIBILI SINGOLARMENTE
LIST OF SPARE PARTS WHICH CAN BE SUPPLIED SEPARATELY

CODICE CODE	DESCRIZIONE DESCRIPTION	Q.TÀ QTY
45504	SONDA ø 5 x 700 FLESSIBILE PROBE ø 5 x 700 FLEXIBLE	1
45505	SONDA ø 5 x 700 METALLO-MALLEABILE PROBE ø 5 x 700 MALLEABLE METAL	1
45506	SONDA ø 6 x 700 FLESSIBILE PROBE ø 6 x 700 FLEXIBLE	1
45516	SONDA ø 6 x 700 METALLO-MALLEABILE PROBE ø 6 x 700 MALLEABLE METAL	1
45517	SONDA ø 7 x 1000 FLESSIBILE PROBE ø 7 x 1000 FLEXIBLE	1
45518	SONDA ø 8 x 700 FLESSIBILE PROBE ø 8 x 700 FLEXIBLE	1
45540	SONDA ø 12 x 700 FLESSIBILE PROBE ø 12 x 700 FLEXIBLE	1
80050	CARRELLO PER CONTENITORI DA 20 - 60 Kg TROLLEY FOR CONTAINERS 20 - 60 Kg	1
996.302	TUBO 1/2" - 2 m - 150 bar HOSE 1/2" - 2 m - 150 bar	2
A839	RACCORDO CONNECTION	1
F947	CARTUCCIA FILTRO FILTER CARTRIDGE	1
KG179	CONTENITORE PORTA SONDE PROBES CONTAINER	1
KG260	FILTRO 1/2" FILTER 1/2"	1
KG263	CODOLO E DADO TANG AND NUT	1
KC266	STAFFA PORTA POMPA WALL BRACKET	1
S104	VUOTOMETRO ø 60 mm VACUUM GAUGE ø 60 mm	1
S518	GOMITO M/M 1/2" G ELBOW M/M 1/2" G	2
S520	VALVOLA UNIDIREZIONALE VALVE	1

Art. KR4550
KIT GUARNIZIONI COMPLETO
COMPOSTO DALLE GUARNIZIONI SOTTO ELENCAE
JOINTS GASKETS LIST
INCLUDING ALL THE GASKETS SHOWN HERE UNDER

CODICE CODE	DESCRIZIONE DESCRIPTION	Q.TÀ QTY
H037	O-RING 3137	1
H052	O-RING 106	2
H053	O-RING 2025	1
H054	O-RING 2018	2
H055	O-RING 2010	1
H059	O-RING 2037	3
H093	O-RING 2050 "VITON"	3
H202	O-RING 2043	2
H453	O-RING 2125 "VITON"	1
H457	O-RING 123 "VITON"	1
H512	O-RING 2050 "VITON 90SH"	1
H517	O-RING 2018 "VITON"	1
H537	O-RING "NBR"	1

Art. KS4580
SET RICAMBI CONSIGLIATI
AI PUNTI VENDITA E ASSISTENZA.
COMPOSTO DAI RICAMBI SOTTO ELENCAE
SPARE PARTS KIT ADVISED
TO THE REPAIR CENTERS. THIS KIT INCLUDES
ALL THE SPARE PARTS SHOWN HERE UNDER

CODICE CODE	DESCRIZIONE DESCRIPTION	Q.TÀ QTY
KR4550	KIT GUARNIZIONI COMPLETO COMPLETE GASKETS KIT	1
KS3383	POMPE Art. 33070 PUMPS Art. 33070	1

tutti i diritti riservati - all rights reserved



Art. 45180

VISTA ESPLOSA - EXPLODED VIEW

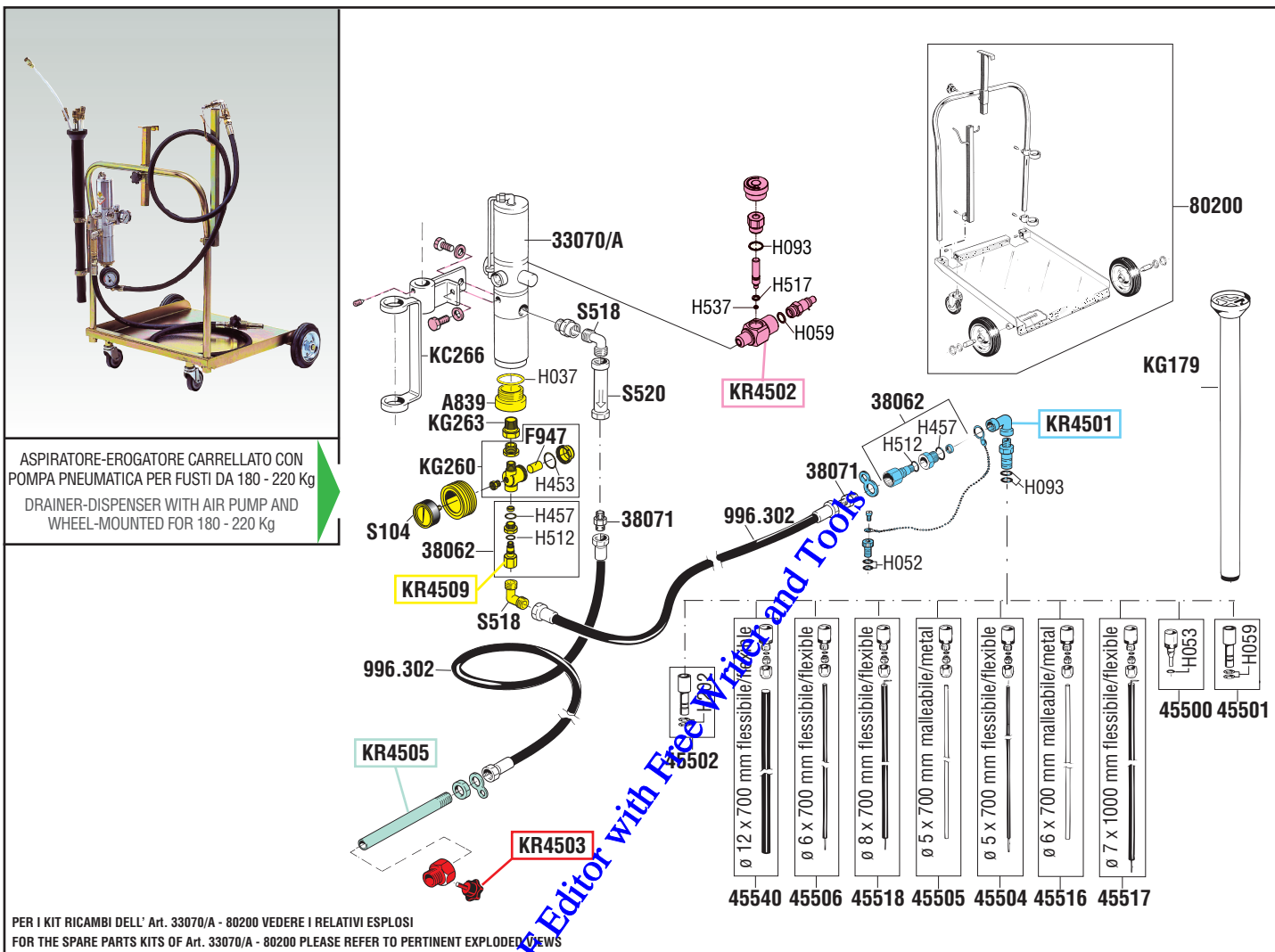

ASPIRATORE-EROGATORE CARRELLATO CON POMPA PNEUMATICA PER FUSTI DA 180 - 220 Kg
DRAINER-DISPENSER WITH AIR PUMP AND WHEEL-MOUNTED FOR 180 - 220 Kg

PER I KIT RICAMBI DELL' Art. 33070/A - 80200 VEDERE I RELATIVI ESPLOSI
FOR THE SPARE PARTS KITS OF Art. 33070/A - 80200 PLEASE REFER TO PERTINENT EXPLODED VIEWS

tutti i diritti riservati - all rights reserved

GUIDA RICAMBI - SPARE PARTS GUIDE

KIT RICAMBI
OGNI KIT SOTTO RIPORTATO COMPRENDE I RICAMBI EVIDENZIATI CON LO STESSO COLORE E LE RELATIVE GUARNIZIONI. QUESTI RICAMBI NON SONO FORNIBILI SEPARATAMENTE TRANNNE QUELLI CODIFICATI.
SPARE PARTS KITS
EACH KIT SHOWN WITH THE SAME COLOR INCLUDES ALSO THE GASKETS. THE SPARE PARTS INCLUDED IN THE KIT CAN'T BE SUPPLIED SEPARATELY EXCEPT THOSE SHOWN WITH A PROPER CODE.

CODICE CODE	DESCRIZIONE DESCRIPTION	Q.TÀ QTY
KR4501	TERMINALE TUBO ASPIRAZIONE COMPLETO COMPLETE HOSE TRAILING	1
KR4502	REGOLATORE DI FLUSSO ARIA AIR FLOW REGULATING VALVE	1
KR4503	GHIERA FUSTO BUNG ADAPTOR	1
KR4505	TERMINALE SCARICO DISCHARGING HOSE TRAILING	1
KR4509	GRUPPO FILTRO CON VUOTOMETRO FILTER GROUP WITH VACUUM GAUGE	1

ELENCO RICAMBI FORNIBILI SINGOLARMENTE
LIST OF SPARE PARTS WHICH CAN BE SUPPLIED SEPARATELY

CODICE CODE	DESCRIZIONE DESCRIPTION	Q.TÀ QTY
33070/A	POMPA DA TRAVASO R 1:1 TRANSFER PUMP R 1:1	1
38062	SNODO GIREVOLE SWIVEL JOINT	1
38071	NIPPLE M 1/2" G x M 1/2" G NIPPLE M 1/2" G x M 1/2" G	2
45500	RACCORDO PER SONDE (VOLKSWAGEN) CONNECTOR FOR PROBES (VOLKSWAGEN)	1
45501	RACCORDO PER SONDE (BMW) CONNECTOR FOR PROBES (BMW)	1
45502	RACCORDO PER SONDE (CITROEN) CONNECTOR FOR PROBES (CITROEN)	1

ELENCO RICAMBI FORNIBILI SINGOLARMENTE
LIST OF SPARE PARTS WHICH CAN BE SUPPLIED SEPARATELY

CODICE CODE	DESCRIZIONE DESCRIPTION	Q.TÀ QTY
45504	SONDA ø 5 x 700 FLESSIBILE PROBE ø 5 x 700 FLEXIBLE	1
45505	SONDA ø 5 x 700 METALLO-MALLEABILE PROBE ø 5 x 700 MALLEABLE METAL	1
45506	SONDA ø 6 x 700 FLESSIBILE PROBE ø 6 x 700 FLEXIBLE	1
45516	SONDA ø 6 x 700 METALLO-MALLEABILE PROBE ø 6 x 700 MALLEABLE METAL	1
45517	SONDA ø 7 x 1000 FLESSIBILE PROBE ø 7 x 1000 FLEXIBLE	1
45518	SONDA ø 8 x 700 FLESSIBILE PROBE ø 8 x 700 FLEXIBLE	1
45540	SONDA ø 12 x 700 FLESSIBILE PROBE ø 12 x 700 FLEXIBLE	1
80200	CARRELLO PER FUSTI DA 180 - 220 Kg TROLLEY FOR DRUMS 180 - 220 Kg	1
996.302	TUBO 1/2" - 2 m - 150 bar HOSE 1/2" - 2 m - 150 bar	2
A839	RACCORDO CONNECTION	1
F947	CARTUCCIA FILTRO FILTER CARTRIDGE	1
KC266	STAFFA PORTA POMPE WALL BRACKET	1
KG179	CONTENITORE PORTA SONDE PROBES CONTAINER	1
KG260	FILTRO 1/2" FILTER 1/2"	1
KG263	CODOLO E DADO TANG AND NUT	1
S104	VUOTOMETRO ø 60 mm VACUUM GAUGE ø 60 mm	1
S518	GOMITO M/M 1/2" G ELBOW M/M 1/2" G	2
S520	VALVOLA UNIDIREZIONALE VALVE	1

Art. KR4550 KIT GUARNIZIONI COMPLETO
COMPOSTO DALLE GUARNIZIONI SOTTO ELENCAE
JOINTS GASKETS LIST INCLUDING ALL THE GASKETS SHOWN HERE UNDER

CODICE CODE	DESCRIZIONE DESCRIPTION	Q.TÀ QTY
H037	O-RING 3137	1
H052	O-RING 106	2
H053	O-RING 2025	1
H054	O-RING 2018	2
H055	O-RING 2010	1
H059	O-RING 2037	3
H093	O-RING 2050 "VITON"	3
H202	O-RING 2043	2
H453	O-RING 2125 "VITON"	1
H457	O-RING 123 "VITON"	1
H512	O-RING 2050 "VITON 90SH"	1
H517	O-RING 2018 "VITON"	1
H537	O-RING "NBR"	1

Art. KS4580 SET RICAMBI CONSIGLIATI
AI PUNTI VENDITA E ASSISTENZA. COMPOSTO DAI RICAMBI SOTTO ELENCAE
SPARE PARTS KIT ADVISED
TO THE REPAIR CENTERS. THIS KIT INCLUDES ALL THE SPARE PARTS SHOWN HERE UNDER

CODICE CODE	DESCRIZIONE DESCRIPTION	Q.TÀ QTY
KR4550	KIT GUARNIZIONI COMPLETO COMPLETE GASKETS KIT	1
KS3383	POMPE - PUMPS 33070	1



Art. 45200



VISTA ESPLOSA - EXPLODED VIEW

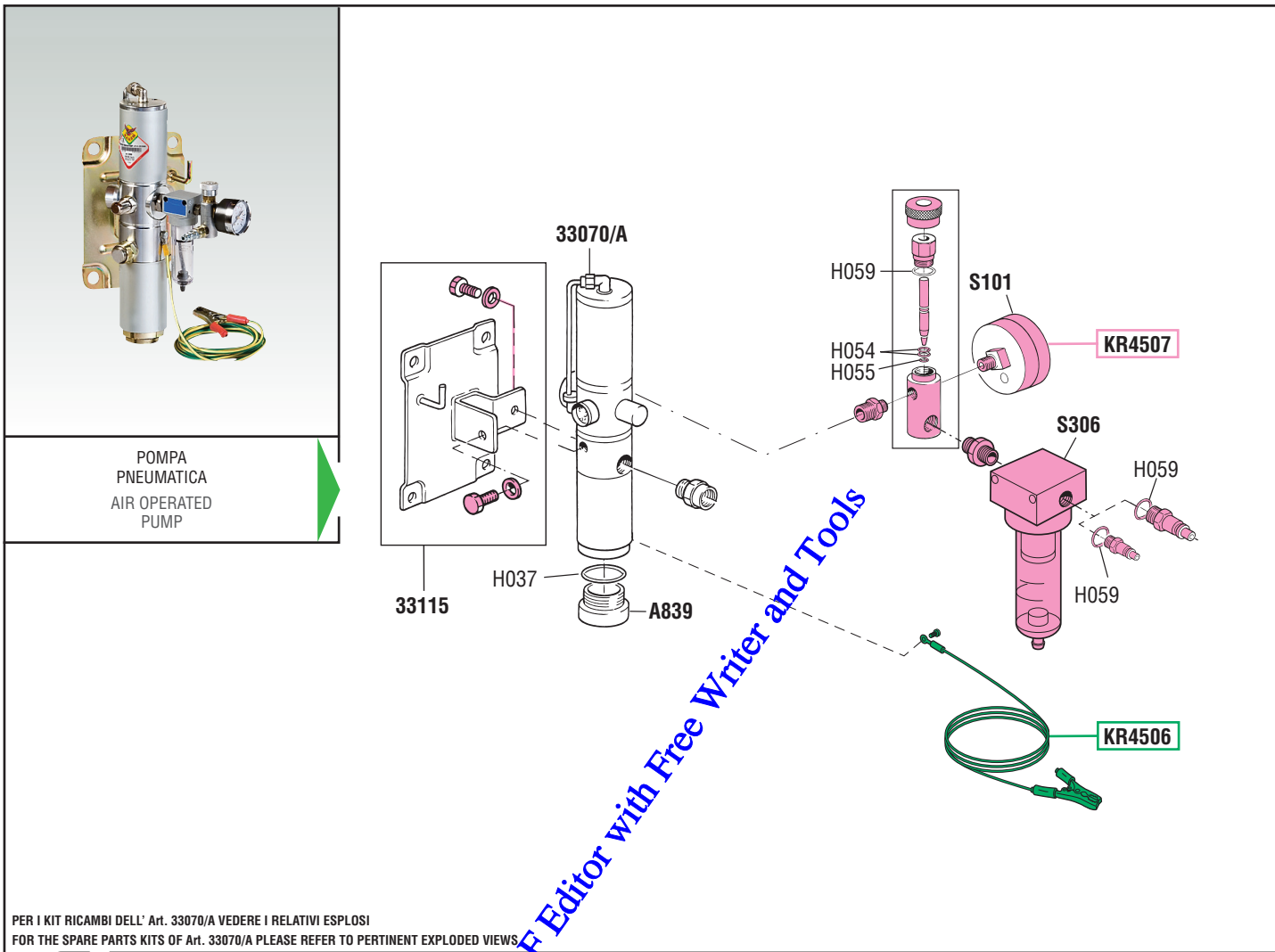

POMPA PNEUMATICA
AIR OPERATED PUMP

PER I KIT RICAMBI DELL' Art. 33070/A VEDERE I RELATIVI ESPLOSI
FOR THE SPARE PARTS KITS OF Art. 33070/A PLEASE REFER TO PERTINENT EXPLODED VIEWS

GUIDA RICAMBI - SPARE PARTS GUIDE

KIT RICAMBI
OGNI KIT SOTTO RIPORTATO COMPRENDE I RICAMBI EVIDENZIATI CON LO STESSO COLORE E LE RELATIVE GUARNIZIONI. QUESTI RICAMBI NON SONO FORNIBILI SEPARATAMENTE TRANNE QUELLI CODIFICATI.

SPARE PARTS KITS
EACH KIT SHOWN WITH THE SAME COLOR INCLUDES ALSO THE GASKETS. THE SPARE PARTS INCLUDED IN THE KIT CAN'T BE SUPPLIED SEPARATELY EXCEPT THOSE SHOWN WITH A PROPER CODE.

CODICE CODE	DESCRIZIONE DESCRIPTION	Q.TÀ QTY
KR4506	CAVO MESSA A TERRA EARTHING CABLE	1
KR4507	REGOLATORE DI FLUSSO ARIA AIR FLOW REGULATION VALVE	1

ELENCO RICAMBI FORNIBILI SINGOLARMENTE
LIST OF SPARE PARTS WHICH CAN BE SUPPLIED SEPARATELY

CODICE CODE	DESCRIZIONE DESCRIPTION	Q.TÀ QTY
33070/A	POMPA DA TRAVASO R 1:1 TRANSFER PUMP R 1:1	1
33115	STAFFA MURALE WALL BRACKET	1
A839	RACCORDO CONNECTION	1
S101	MANOMETRO ø 50 mm GAUGE ø 50 mm	1
S306	FILTRO FF 1/4" G FILTER FF 1/4" G	2

Art. KR4561 **KIT GUARNIZIONI COMPLETO**
COMPOSTO DALLE GUARNIZIONI SOTTO ELENCAE
JOINTS GASKETS LIST
INCLUDING ALL THE GASKETS SHOWN HERE UNDER

CODICE CODE	DESCRIZIONE DESCRIPTION	Q.TÀ QTY
H037	O-RING 3137 O-RING 3137	1
H054	O-RING 2018 O-RING 2018	2
H055	O-RING 2010 O-RING 2010	1
H059	O-RING 2037 O-RING 2037	3

Art. KS4585 **SET RICAMBI CONSIGLIATI**
AI PUNTI VENDITA E ASSISTENZA,
COMPOSTO DAI RICAMBI SOTTO ELENCAE
SPARE PARTS KIT ADVISED
TO THE REPAIR CENTERS. THIS KIT INCLUDES
ALL THE SPARE PARTS SHOWN HERE UNDER

CODICE CODE	DESCRIZIONE DESCRIPTION	Q.TÀ QTY
KR4561	KIT GUARNIZIONI COMPLETO COMPLETE GASKETS KIT	1
KS3383	POMPE Art. 33070 PUMPS Art. 33070	1

tutti i diritti riservati - all rights reserved



Art. 45250

VISTA ESPLOSA - EXPLODED VIEW



ASPIRATORE AZIONATO DA POMPA PNEUMATICA, CARRELLATO PER FUSTI DA 30 - 60 Kg
DRAINER OPERATED BY AIR PUMP AND WHEEL-MOUNTED FOR 30 - 60 Kg

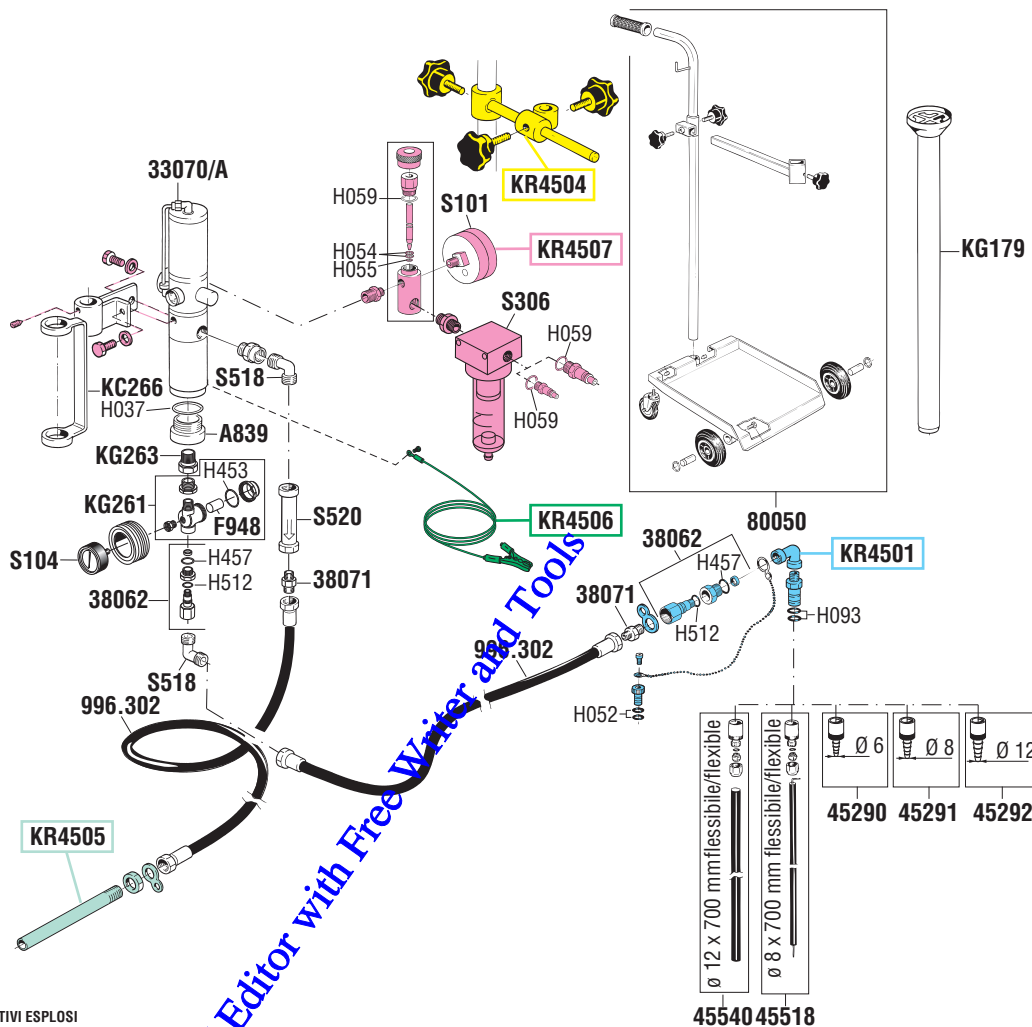

PER I KIT RICAMBI DELL' Art. 33070/A - 80050 VEDERE I RELATIVI ESPLOSI
FOR THE SPARE PARTS KITS OF Art. 33070/A - 80050 PLEASE REFER TO PERTINENT EXPLODED VIEWS

GUIDA RICAMBI - SPARE PARTS GUIDE

KIT RICAMBI
OGNI KIT SOTTO RIPORTATO COMPRENDE I RICAMBI EVIDENZIATI CON LO STESSO COLORE E LE RELATIVE GUARNIZIONI. QUESTI RICAMBI NON SONO FORNIBILI SEPARATAMENTE TRANNNE QUELLI CODIFICATI.

SPARE PARTS KITS
EACH KIT SHOWN WITH THE SAME COLOR INCLUDES ALSO THE GASKETS. THE SPARE PARTS INCLUDED IN THE KIT CAN'T BE SUPPLIED SEPARATELY EXCEPT THOSE SHOWN WITH A PROPER CODE.

CODICE CODE	DESCRIZIONE DESCRIPTION	Q.TÀ QTY
KR4501	TERMINALE TUBO ASPIRAZIONE COMPLETO COMPLETE HOSE TRAILING	1
KR4504	SUPPORTO TERMINALE SCARICO DISCHARGING HOSE SUPPORT	1
KR4505	TERMINALE SCARICO DISCHARGING HOSE TRAILING	1
KR4506	CAVO MESSA A TERRA EARTHING CABLE	1
KR4507	REGOLATORE DI FLUSSO ARIA AIR FLOW REGULATING VALVE	1

ELENCO RICAMBI FORNIBILI SINGOLARMENTE
LIST OF SPARE PARTS WHICH CAN BE SUPPLIED SEPARATELY

CODICE CODE	DESCRIZIONE DESCRIPTION	Q.TÀ QTY
45292	RACCORDO ø 10 mm CONNECTION ø 10 mm	1
45518	SONDA ø 8 x 700 FLESSIBILE PROBE ø 8 x 700 FLEXIBLE	1
45540	SONDA ø 12 x 700 FLESSIBILE PROBE ø 12 x 700 FLEXIBLE	1
80050	CARRELO PER CONTENITORI DA 20 - 60 Kg TROLLEY FOR CONTAINERS 20 - 60 Kg	1
996.302	TUBO 1/2" - 2 m - 150 bar HOSE 1/2" - 2 m - 150 bar	2
A839	RACCORDO CONNECTION	1
F948	FILTRO FILTER	1
KC266	STAFFA PORTA POMPA WALL BRACKET	1
KG179	CONTENITORE PORTA SONDE PROBES CONTAINER	1
KG261	FILTRO 1/2" FILTER 1/2"	1
KG263	CODOLO E DADO TANG AND NUT	1
S101	MANOMETRO ø 50 mm GAUGE ø 50 mm	1
S104	VUOTOMETRO ø 60 mm VACUUM GAUGE ø 60 mm	1
S306	FILTRO FF 1/4" G FILTER FF 1/4" G	1
S518	GOMITO M/M 1/2" G ELBOW M/M 1/2" G	2
S520	VALVOLA UNIDIREZIONALE VALVE	1

Art. KR4560 KIT GUARNIZIONI COMPLETO
COMPOSTO DALLE GUARNIZIONI SOTTO ELENCAE JOINTS GASKETS LIST INCLUDING ALL THE GASKETS SHOWN HERE UNDER

CODICE CODE	DESCRIZIONE DESCRIPTION	Q.TÀ QTY
H037	O-RING 3137 O-RING 3137	1
H052	O-RING 106 O-RING 106	2
H054	O-RING 2018 O-RING 2018	2
H055	O-RING 2010 O-RING 2010	1
H059	O-RING 2037 O-RING 2037	3
H093	O-RING 2050 "VITON" O-RING 2050 "VITON"	2
H453	O-RING 2125 "VITON" O-RING 2125 "VITON"	1
H457	O-RING 123 "VITON" O-RING 123 "VITON"	2
H512	O-RING 2050 "VITON 90SH" O-RING 2050 "VITON 90SH"	2

Art. KS4582 SET RICAMBI CONSIGLIATI
AI PUNTI VENDITA E ASSISTENZA, COMPOSTO DAI RICAMBI SOTTO ELENCAE
SPARE PARTS KIT ADVISED
TO THE REPAIR CENTERS. THIS KIT INCLUDES ALL THE SPARE PARTS SHOWN HERE UNDER

CODICE CODE	DESCRIZIONE DESCRIPTION	Q.TÀ QTY
KR4560	KIT GUARNIZIONI COMPLETO COMPLETE GASKETS KIT	1
KS3383	POMPE Art. 33070 PUMPS Art. 33070	1

ELENCO RICAMBI FORNIBILI SINGOLARMENTE
LIST OF SPARE PARTS WHICH CAN BE SUPPLIED SEPARATELY

CODICE CODE	DESCRIZIONE DESCRIPTION	Q.TÀ QTY
33070/A	POMPA DA TRAVASO R 1:1 TRANSFER PUMP R 1:1	1
38062	SNODO GIREVOLE SWIVEL JOINT	1
38071	NIPPLE M 1/2" G x M 1/2" G NIPPLE M 1/2" G x M 1/2" G	2
45290	RACCORDO ø 6 mm CONNECTION ø 6 mm	1
45291	RACCORDO ø 8 mm CONNECTION ø 8 mm	1

tutti i diritti riservati - all rights reserved



Art. 45300

VISTA ESPLOSA - EXPLODED VIEW

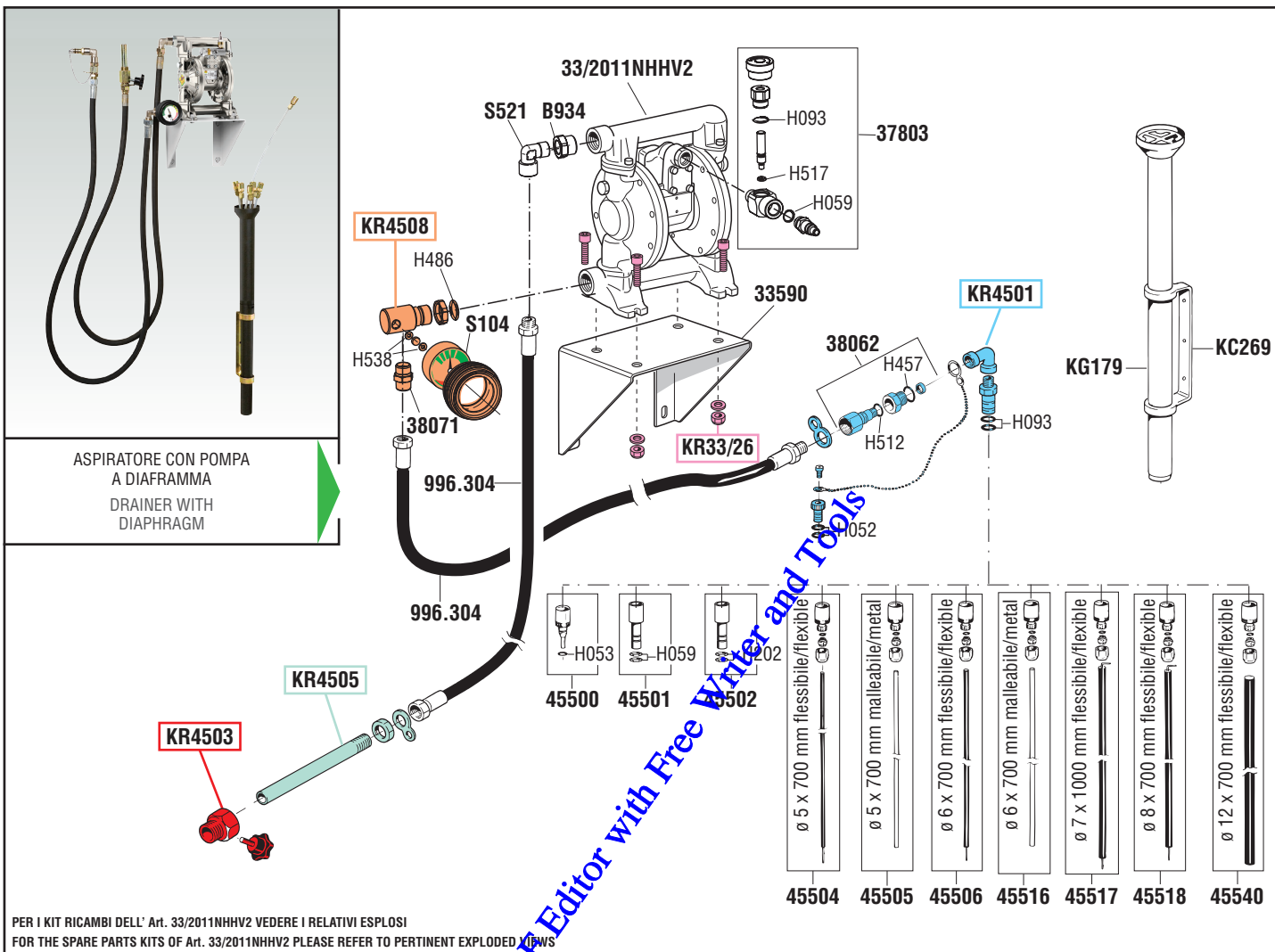

ASPIRATORE CON POMPA A DIAFRAMMA
DRAINER WITH DIAPHRAGM

PER I KIT RICAMBI DELL' Art. 33/2011NHHV2 VEDERE I RELATIVI ESPLOSI
FOR THE SPARE PARTS KITS OF Art. 33/2011NHHV2 PLEASE REFER TO PERTINENT EXPLODED VIEWS

tutti i diritti riservati - all rights reserved

GUIDA RICAMBI - SPARE PARTS GUIDE

KIT RICAMBI
OGNI KIT SOTTO RIPORTATO COMPRENDE I RICAMBI EVIDENZIATI CON LO STESSO COLORE E LE RELATIVE GUARNIZIONI. QUESTI RICAMBI NON SONO FORNIBILI SEPARATAMENTE TRANNNE QUELLI CODIFICATI.

SPARE PARTS KITS
EACH KIT SHOWN WITH THE SAME COLOR INCLUDES ALSO THE GASKETS. THE SPARE PARTS INCLUDED IN THE KIT CAN'T BE SUPPLIED SEPARATELY EXCEPT THOSE SHOWN WITH A PROPER CODE.

CODICE CODE	DESCRIZIONE DESCRIPTION	Q.TÀ QTY
KR33/26	VITERIA SCREWS	1
KR4501	TERMINALE TUBO ASPIRAZIONE COMPLETO COMPLETE HOSE TRAILING	1
KR4503	GHIERA FUSTO BUNG ADAPTOR	1
KR4505	TERMINALE SCARICO DISCHARGING HOSE TRAILING	1
KR4508	KIT VUOTOMETRO VACUUM GAUGE KIT	1

ELENCO RICAMBI FORNIBILI SINGOLARMENTE
LIST OF SPARE PARTS WHICH CAN BE SUPPLIED SEPARATELY

CODICE CODE	DESCRIZIONE DESCRIPTION	Q.TÀ QTY
38062	SNODO GIREVOLE SWIVEL JOINT	1
38071	NIPPLE M 1/2" G x M 1/2" G NIPPLE M 1/2" G x M 1/2" G	1
45500	RACCORDO PER SONDE (VOLKSWAGEN) CONNECTOR FOR PROBES (VOLKSWAGEN)	1
45501	RACCORDO PER SONDE (BMW) CONNECTOR FOR PROBES (BMW)	1
45502	RACCORDO PER SONDE (CITROEN) CONNECTOR FOR PROBES (CITROEN)	1
45504	SONDA ø 5 x 700 FLESSIBILE PROBE ø 5 x 700 FLEXIBLE	1
45505	SONDA ø 5 x 700 METALLO-MALLEABILE PROBE ø 5 x 700 MALLEABLE METAL	1
45506	SONDA ø 6 x 700 FLESSIBILE PROBE ø 6 x 700 FLEXIBLE	1
45516	SONDA ø 6 x 700 METALLO-MALLEABILE PROBE ø 6 x 700 MALLEABLE METAL	1
45517	SONDA ø 7 x 700 FLESSIBILE PROBE ø 7 x 700 FLEXIBLE	1
45518	SONDA ø 8 x 700 FLESSIBILE PROBE ø 8 x 700 FLEXIBLE	1
45540	SONDA ø 12 x 700 FLESSIBILE PROBE ø 12 x 700 FLEXIBLE	1
B934	ADATTATORE M 3/4" G x M 1/2" G ADAPTOR M 3/4" G x M 1/2" G	1
KC269	STAFFA PORTA SONDE MURALE PROBES CONTAINER BRACKET	1
KG179	CONTENITORE PORTA SONDE PROBES CONTAINER	1
S104	VUOTOMETRO ø 60 mm VACUUM GAUGE ø 60 mm	1
S521	GOMITO M/F 1/2" G ELBOW M/F 1/2" G	1

Art. KR4570 **KIT GUARNIZIONI COMPLETO**
COMPOSTO DALLE GUARNIZIONI SOTTO ELENCAE
JOINTS GASKETS LIST
INCLUDING ALL THE GASKETS SHOWN HERE UNDER

CODICE CODE	DESCRIZIONE DESCRIPTION	Q.TÀ QTY
H052	O-RING 106 O-RING 106	2
H053	O-RING 2025 O-RING 2025	1
H059	O-RING 2037 O-RING 2037	3
H093	O-RING 2050 "VITON" O-RING 2050 "VITON"	3
H202	O-RING 2043 O-RING 2043	2
H457	O-RING 123 "VITON" O-RING 123 "VITON"	1
H486	O-RING 3093 "VITON" O-RING 3093 "VITON"	1
H512	O-RING 2050 "VITON 90SH" O-RING 2050 "VITON 90SH"	1
H517	O-RING 2018 "VITON" O-RING 2018 "VITON"	1
H538	RONDELLA WASHER	2

Art. KS4583 **SET RICAMBI CONSIGLIATI**
AI PUNTI VENDITA E ASSISTENZA,
COMPOSTO DAI RICAMBI SOTTO ELENCAE
SPARE PARTS KIT ADVISED
TO THE REPAIR CENTERS. THIS KIT INCLUDES
ALL THE SPARE PARTS SHOWN HERE UNDER

CODICE CODE	DESCRIZIONE DESCRIPTION	Q.TÀ QTY
KR4570	KIT GUARNIZIONI COMPLETO COMPLETE GASKETS KIT	1
KS33/84	SET RICAMBI CONSIGLIATI POMPA PUMP SPARE PARTS KIT ADVISED	1

ELENCO RICAMBI FORNIBILI SINGOLARMENTE
LIST OF SPARE PARTS WHICH CAN BE SUPPLIED SEPARATELY

CODICE CODE	DESCRIZIONE DESCRIPTION	Q.TÀ QTY
33/2011NHHV2	POMPA A DIAFRAMMA S. 3/4" DIAPHRAGM PUMP S. 3/4"	1
996.304	TUBO 1/2" - 4 m - 150 bar HOSE 1/2" - 4 m - 150 bar	2
33590	STAFFA MURALE WALL BRACKET	1
37803	KIT REGOLAZIONE FLUSSO ARIA AIR FLOW REGULATOR KIT	1



Art. 45310 - Art. 45311



VISTA ESPLOSA - EXPLODED VIEW

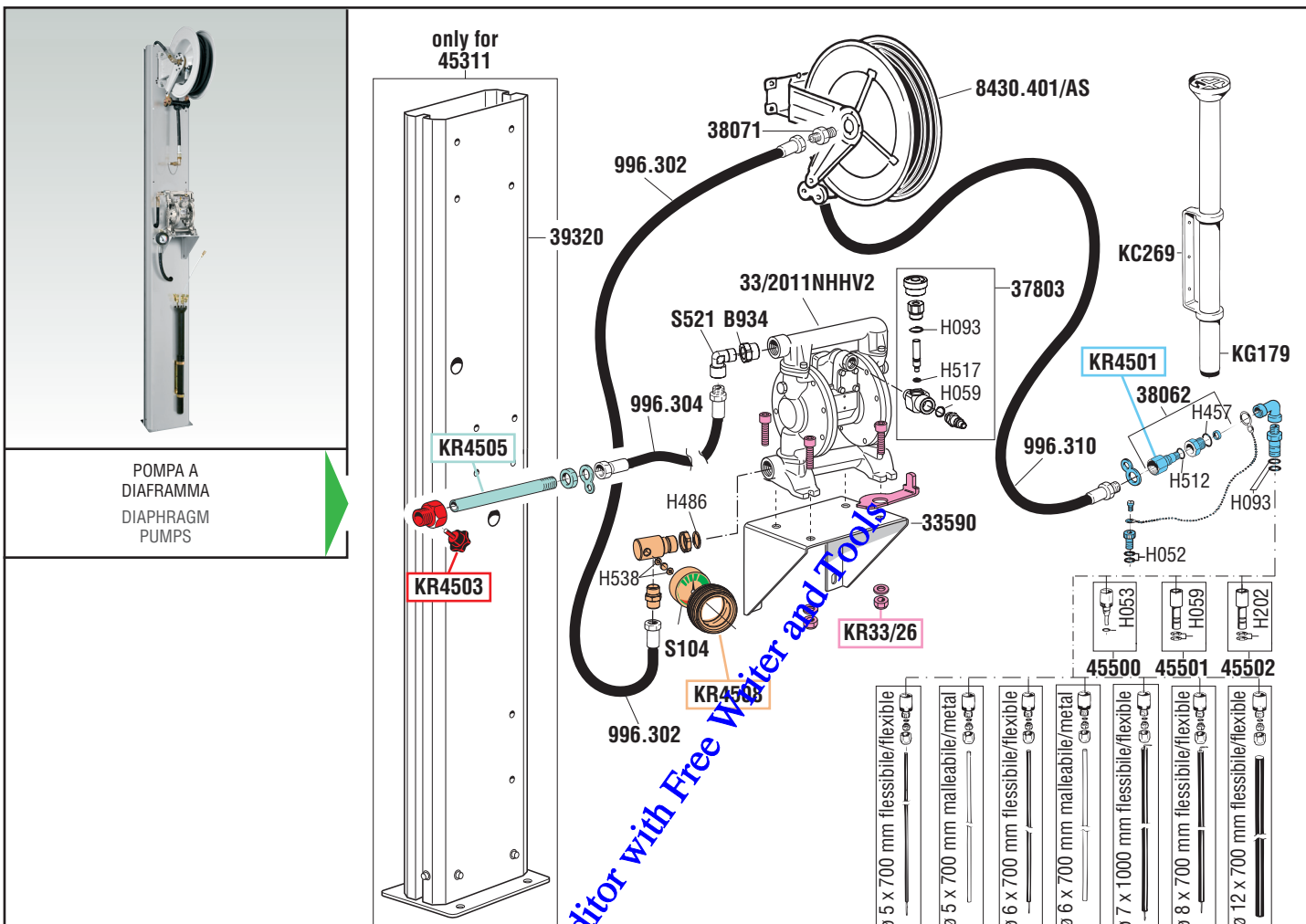

POMPA A DIAFRAMMA
DIAPHRAGM
PUMPS

PER I KIT RICAMBI DELL' Art. 33/2011NHHV2 - 8430.401/AS - 39320 VEDERE I RELATIVI ESPLOSI
FOR THE SPARE PARTS KITS OF Art. 33/2011NHHV2 - 8430.401/AS - 39320 PLEASE REFER TO PERTINENT EXPLODED VIEWS

45504 45505 45506 45516 45517 45518 45540

tutti i diritti riservati - all rights reserved

GUIDA RICAMBI - SPARE PARTS GUIDE

KIT RICAMBI
OGNI KIT SOTTO RIPORTATO COMPRENDE I RICAMBI EVIDENZIATI CON LO STESSO COLORE E LE RELATIVE GUARNIZIONI. QUESTI RICAMBI NON SONO FORNIBILI SEPARATAMENTE TRANNE QUELLI CODIFICATI.

SPARE PARTS KITS
EACH KIT SHOWN WITH THE SAME COLOR INCLUDES ALSO THE GASKETS. THE SPARE PARTS INCLUDED IN THE KIT CAN'T BE SUPPLIED SEPARATELY EXCEPT THOSE SHOWN WITH A PROPER CODE.

CODICE CODE	DESCRIZIONE DESCRIPTION	Q.TÀ QTY
KR33/26	VITERIA SCREWS	1
KR4501	TERMINALE TUBO ASPIRAZIONE COMPLETO COMPLETE HOSE TRAILING	1
KR4503	GHIERA FUSTO BUNG ADAPTOR	1
KR4505	TERMINALE SCARICO DISCHARGING HOSE TRAILING	1
KR4508	KIT VUOTOMETRO VACUUM GAUGE KIT	1

ELENCO RICAMBI FORNIBILI SINGOLARMENTE
LIST OF SPARE PARTS WHICH CAN BE SUPPLIED SEPARATELY

CODICE CODE	DESCRIZIONE DESCRIPTION	Q.TÀ QTY
33/2011NHHV2	POMPA A DIAFRAMMA S. 3/4" DIAPHRAGM PUMP S. 3/4"	1
33590	STAFFA MURALE WALL BRACKET	1
37803	KIT REGOLAZIONE FLUSSO ARIA AIR FLOW REGULATOR KIT	1
38062	SNODO GIREVOLE SWIVEL JOINT	1
38071	NIPPLE M 1/2" G x M 1/2" G NIPPLE M 1/2" G x M 1/2" G	2
39320	COLONNA DI SERVIZIO FRONTALE SINGLE POST SERVICE COLUMN	1
45500	RACCORDO PER SONDE (VOLKSWAGEN) CONNECTOR FOR PROBES (VOLKSWAGEN)	1

ELENCO RICAMBI FORNIBILI SINGOLARMENTE
LIST OF SPARE PARTS WHICH CAN BE SUPPLIED SEPARATELY

CODICE CODE	DESCRIZIONE DESCRIPTION	Q.TÀ QTY
45501	RACCORDO PER SONDE (BMW) CONNECTOR FOR PROBES (BMW)	1
45502	RACCORDO PER SONDE (CITROEN) CONNECTOR FOR PROBES (CITROEN)	1
45504	SONDA ø 5 x 700 FLESSIBILE PROBE ø 5 x 700 FLEXIBILE	1
45505	SONDA ø 5 x 700 METALLO-MALLEABILE PROBE ø 5 x 700 MALLEABLE METAL	1
45506	SONDA ø 6 x 700 FLESSIBILE PROBE ø 6 x 700 FLEXIBILE	1
45516	SONDA ø 6 x 700 METALLO-MALLEABILE PROBE ø 6 x 700 MALLEABLE METAL	1
45517	SONDA ø 7 x 700 FLESSIBILE PROBE ø 7 x 700 FLEXIBILE	1
45518	SONDA ø 8 x 700 FLESSIBILE PROBE ø 8 x 700 FLEXIBILE	1
45540	SONDA ø 12 x 700 FLESSIBILE PROBE ø 12 x 700 FLEXIBILE	1
8430.401/AS	AVVOLGITUBO PER ASPIRAZIONE SUCTION HOSE REEL	1
996.302	TUBO 1/2" - 2 m - 150 bar HOSE 1/2" - 2 m - 150 bar	1
996.304	TUBO 1/2" - 4 m - 150 bar HOSE 1/2" - 4 m - 150 bar	1
996.310	TUBO 1/2" - 10 m - 150 bar HOSE 1/2" - 10 m - 150 bar	1
B934	ADATTATORE M 3/4" G x M 1/2" G ADAPTOR M 3/4" G x M 1/2" G	1
KC269	STAFFA PORTA SONDE MURALE PROBES CONTAINER BRACKET	1
KG179	CONTENITORE PORTA SONDE PROBES CONTAINER	1
S104	VUOTOMETRO ø 60 mm VACUUM GAUGE ø 60 mm	1
S521	GOMITO M/F 1/2" G ELBOW M/F 1/2" G	1

Art. KR4570 KIT GUARNIZIONI COMPLETO
COMPOSTO DALLE GUARNIZIONI SOTTO ELENCAE
JOINTS GASKETS LIST
INCLUDING ALL THE GASKETS SHOWN HERE UNDER

CODICE CODE	DESCRIZIONE DESCRIPTION	Q.TÀ QTY
H052	O-RING 106 O-RING 106	2
H053	O-RING 2025 O-RING 2025	1
H059	O-RING 2037 O-RING 2037	3
H093	O-RING 2050 "VITON" O-RING 2050 "VITON"	3
H202	O-RING 2043 O-RING 2043	2
H457	O-RING 123 "VITON" O-RING 123 "VITON"	1
H486	O-RING 3093 "VITON" O-RING 3093 "VITON"	1
H512	O-RING 2050 "VITON 90SH" O-RING 2050 "VITON 90SH"	1
H517	O-RING 2018 "VITON" O-RING 2018 "VITON"	1
H538	RONDELLA WASHER	2

Art. KS4584 SET RICAMBI CONSIGLIATI
AI PUNTI VENDITA E ASSISTENZA, COMPOSTO DAI RICAMBI SOTTO ELENCAE
SPARE PARTS KIT ADVISED TO THE REPAIR CENTERS. THIS KIT INCLUDES ALL THE SPARE PARTS SHOWN HERE UNDER

CODICE CODE	DESCRIZIONE DESCRIPTION	Q.TÀ QTY
KR4570	KIT GUARNIZIONI COMPLETO COMPLETE GASKETS KIT	1
KS33/80	SET RICAMBI CONSIGLIATI POMPA PUMP SPARE PARTS KIT ADVISED	1
KG197	SNODO PER KIT ASPIRAZIONE DRAINING KIT JOINT	1



Art. 46064 Mod. R.O.P. 65L



VISTA ESPLOSA - EXPLODED VIEW



RECUPERATORE UNIVERSALE PER OLIO ESAUSTO CON SERBATOIO DA 65 l
UNIVERSAL WASTE OIL DRAINER WITH 65 l TANK

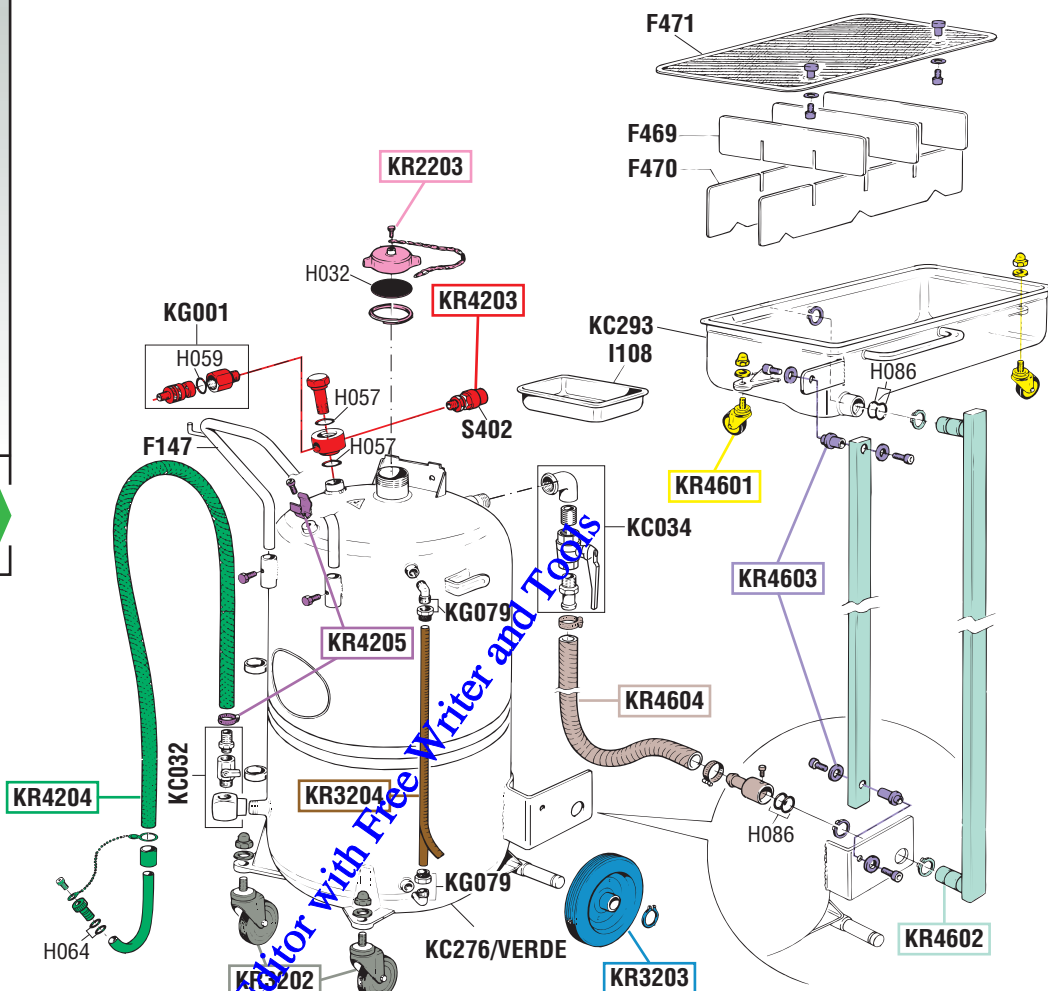

GUIDA RICAMBI - SPARE PARTS GUIDE

KIT RICAMBI
OGNI KIT SOTTO RIPORTATO COMPRENDE I RICAMBI EVIDENZIATI CON LO STESSO COLORE E LE RELATIVE GUARNIZIONI. QUESTI RICAMBI NON SONO FORNIBILI SEPARATAMENTE TRANNE QUELLI CODIFICATI.
SPARE PARTS KITS
EACH KIT SHOWN WITH THE SAME COLOR INCLUDES ALSO THE GASKETS. THE SPARE PARTS INCLUDED IN THE KIT CAN'T BE SUPPLIED SEPARATELY EXCEPT THOSE SHOWN WITH A PROPER CODE.

CODICE CODE	DESCRIZIONE DESCRIPTION	Q.TÀ QTY
KR2203	TAPPO ALTA PRESSIONE HIGH PRESSURE PLUG	1
KR3202	DUE RUOTE PIROETTANTI CON DADI TWO SWIVELLING WHEELS WITH NUTS	1
KR3203	2 RUOTE FISSI CON ANELLI ELASTICI 2 FIXED WHEELS WITH RETAINING RINGS	1
KR3204	TUBO DI LIVELLO ED ETICHETTA GAUGE TUBE AND LABEL	1
KR4203	GRUPPO RUBINETTO-VALVOLA DI SICUREZZA AIR TAP AND SAFETY VALVE GROUP	1
KR4204	TUBO SCARICO CON FASCETTA STRINGI TUBO DISCHARGING HOSE WITH HOSE CLAMP	1
KR4205	SET DI VITI PER SERBATOIO SET OF SCREWS FOR RESERVOIR	1
KR4601	DUE RUOTE PIROETTANTI CON DADI TWO SWIVELLING WHEELS WITH NUTS	1
KR4602	KIT DUE BRACCI PER RECUP. A PANTOGRAFO TWO ARMS KIT FOR PANTOGRAPH DRAINER	1
KR4603	SET VITI PER BRACCI PANTOGRAFO SET OF SCREWS FOR PANTOGRAPH ARMS	1
KR4604	TUBO FLESSIBILE PER SERBATIO 65 l CONNECTING HOSE FOR 65 l RESERVOIR	1

ELENCO RICAMBI FORNIBILI SINGOLARMENTE
LIST OF SPARE PARTS WHICH CAN BE SUPPLIED SEPARATELY

CODICE CODE	DESCRIZIONE DESCRIPTION	Q.TÀ QTY
I108	VASCETTA PORTA OGGETTI TOOL TRAY	1
F469	FRANGIFLUTTO SPLASH RETAINER	3
F470	FRANGIFLUTTO SPLASH RETAINER	2
F471	GRIGLIA NET	1
KC032	GRUPPO SCARICO SERBATOIO DISCHARGING GROUP	1
KC034	GRUPPO SCARICO DISCHARGING GROUP	1
F147	MANICO A "U" HANDLE	1
KC276/VERDE	SERBATOIO 65 l RESERVOIR 65 l	1
KC293	COPPA RACCOGLI OLIO COLLECTING BASIN	1
KG001	RUBINETTO UNIVERSALE CARICA ARIA UNIVERSAL AIR TAP	1
KG079	GRUPPO GOMITO E GHIERA RING AND ELBOW JOINT GROUP	2
S402	VALVOLA DI SICUREZZA 1 bar SAFETY VALVE 1 bar	1

Art. KR4650 KIT GUARNIZIONI COMPLETO
COMPOSTO DALLE GUARNIZIONI SOTTO ELENCAE
JOINTS GASKETS LIST
INCLUDING ALL THE GASKETS SHOWN HERE UNDER

CODICE CODE	DESCRIZIONE DESCRIPTION	Q.TÀ QTY
H032	GUARNIZIONE TAPPO GASKET	1
H057	O-RING 2062 O-RING 2062	2
H059	O-RING 2037 O-RING 2037	1
H064	O-RING 3043 O-RING 3043	2
H086	O-RING 4118 O-RING 4118	4

Art. KS4680 SET RICAMBI CONSIGLIATI
AI PUNTI VENDITA E ASSISTENZA, COMPOSTO DAI RICAMBI SOTTO ELENCAE
SPARE PARTS KIT ADVISED
TO THE REPAIR CENTERS. THIS KIT INCLUDES ALL THE SPARE PARTS SHOWN HERE UNDER

CODICE CODE	DESCRIZIONE DESCRIPTION	Q.TÀ QTY
KR4204	TUBO SCARICO CON FASCETTA STRINGI TUBO DISCHARGING HOSE WITH HOSE CLAMP	1
KR4604	TUBO FLESSIBILE PER SERBATIO 65 l CONNECTING HOSE FOR 65 l RESERVOIR	1
KR4650	KIT GUARNIZIONI COMPLETO COMPLETE GASKETS KIT	1

tutti i diritti riservati - all rights reserved



Art. 46065 Mod. R/AO.P. 65L



VISTA ESPLOSA - EXPLODED VIEW

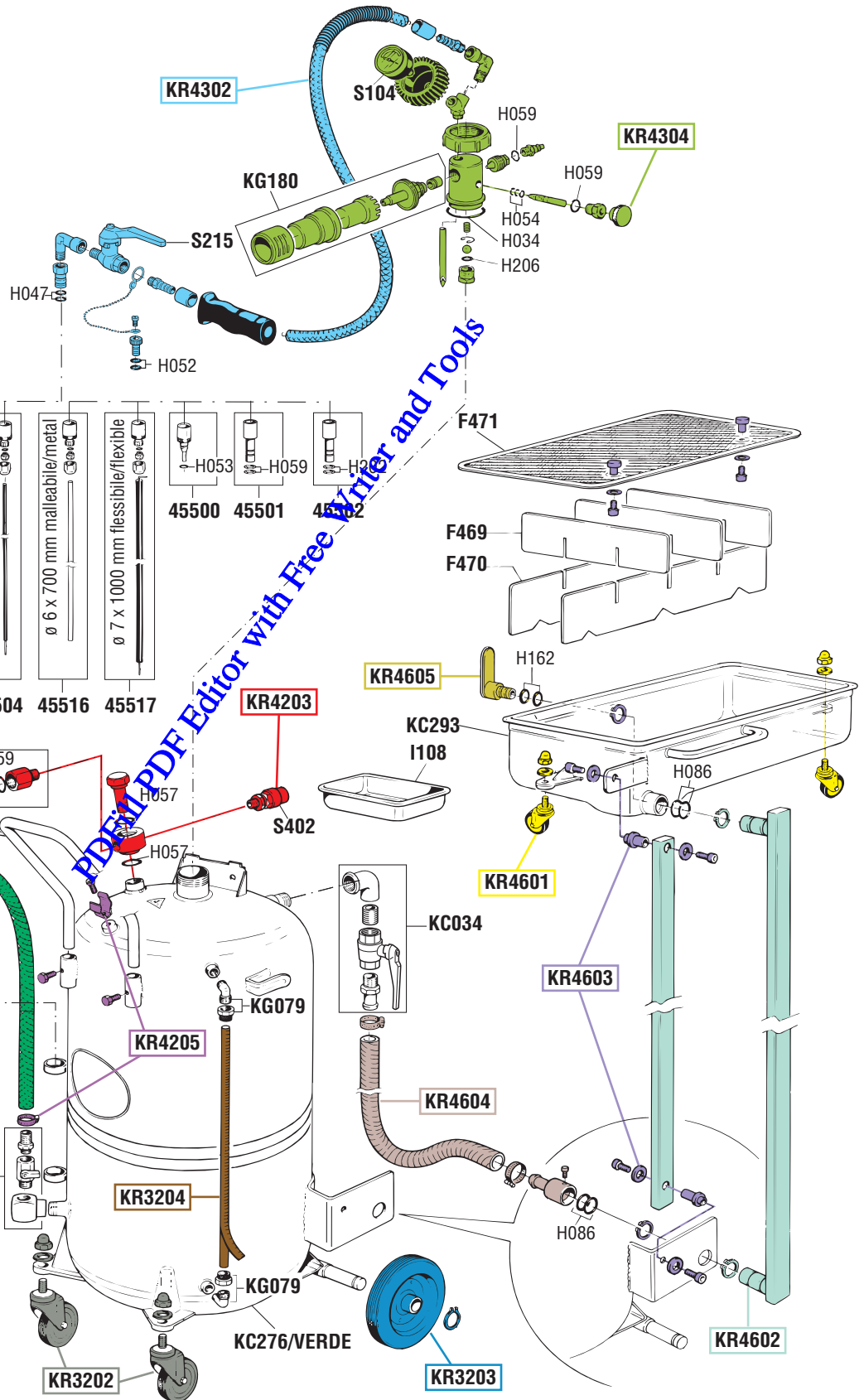

- Ø 6 x 700 mm flessibile/flexible 45506
- Ø 8 x 700 mm flessibile/flexible 45518
- Ø 5 x 700 mm malleabile/metal 45505
- Ø 5 x 700 mm flessibile/flexible 45504
- Ø 6 x 700 mm malleabile/metal 45516
- Ø 7 x 1000 mm flessibile/flexible 45517

PDF Editor with Free Writer and Tools

tutti i diritti riservati - all rights reserved



GUIDA RICAMBI - SPARE PARTS GUIDE

KIT RICAMBI OGNI KIT SOTTO RIPORTATO COMPRENDE I RICAMBI EVIDENZIATI CON LO STESSO COLORE E LE RELATIVE GUARNIZIONI. QUESTI RICAMBI NON SONO FORNIBILI SEPARATAMENTE TRANNE QUELLI CODIFICATI.		
SPARE PARTS KITS EACH KIT SHOWN WITH THE SAME COLOR INCLUDES ALSO THE GASKETS. THE SPARE PARTS INCLUDED IN THE KIT CAN'T BE SUPPLIED SEPARATELY EXCEPT THOSE SHOWN WITH A PROPER CODE.		
CODICE CODE	DESCRIZIONE DESCRIPTION	Q.TÀ QTY
KR3202	DUE RUOTE PIROETTANTI CON DADI TWO SWIVELLING WHEELS WITH NUTS	1
KR3203	2 RUOTE FISSE CON ANELLI ELASTICI 2 FIXED WHEELS WITH RETAINING RINGS	1
KR3204	TUBO DI LIVELLO ED ETICHETTA GAUGE TUBE AND LABEL	1
KR4203	GRUPPO RUBINETTO-VALVOLA DI SICUREZZA AIR TAP AND SAFETY VALVE GROUP	1
KR4204	TUBO SCARICO CON FASCETTA STRINGI TUBO DISCHARGING HOSE WITH HOSE CLAMP	1
KR4205	SET DI VITI PER SERBATOIO SET OF SCREWS FOR RESERVOIR	1
KR4302	TUBO ASPIRAZIONE COMPLETO COMPLETE SUCTION HOSE	1
KR4304	GRUPPO ASPIRAZIONE CON RUBINETTO SUCTION GROUP WITH TAP	1
KR4601	DUE RUOTE PIROETTANTI CON DADI TWO SWIVELLING WHEELS WITH NUTS	1
KR4602	KIT DUE BRACCI PER RECUP. A PANTOGRAFO TWO ARMS KIT FOR PANTOGRAPH DRAINER	1
KR4603	SET VITI PER BRACCI PANTOGRAFO SET OF SCREWS FOR PANTOGRAPH ARMS	1
KR4604	TUBO FLESSIBILE PER SERBATIO 65 I CONNECTING HOSE FOR 65 I RESERVOIR	1
KR4605	TAPPO RIDUTTORE ASPIRAZIONE SUCTION REDUCTION PLUG	1

ELENCO RICAMBI FORNIBILI SINGOLARMENTE LIST OF SPARE PARTS WHICH CAN BE SUPPLIED SEPARATELY		
CODICE CODE	DESCRIZIONE DESCRIPTION	Q.TÀ QTY
45500	RACCORDO PER SONDE (VOLKSWAGEN) CONNECTOR FOR PROBES (VOLKSWAGEN)	1
45501	RACCORDO PER SONDE (BMW) CONNECTOR FOR PROBES (BMW)	1
45502	RACCORDO PER SONDE (CITROEN) CONNECTOR FOR PROBES (CITROEN)	1
45504	SONDA ø 5 x 700 FLESSIBILE PROBE ø 5 x 700 FLEXIBLE	1
45505	SONDA ø 5 x 700 METALLO-MALLEABILE PROBE ø 5 x 700 MALLEABLE METAL	1
45506	SONDA ø 6 x 700 FLESSIBILE PROBE ø 6 x 700 FLEXIBLE	1
45516	SONDA ø 6 x 700 METALLO-MALLEABILE PROBE ø 6 x 700 MALLEABLE METAL	1
45517	SONDA ø 7 x 1000 FLESSIBILE PROBE ø 7 x 1000 FLEXIBLE	1
45518	SONDA ø 8 x 700 FLESSIBILE PROBE ø 8 x 700 FLEXIBLE	1
I108	VASCHETTA PORTA OGGETTI TOOL TRAY	1
F469	FRANGIFLUTTO SPASH RETAINER	3
F470	FRANGIFLUTTO SPASH RETAINER	2
F471	GRIGLIA NET	1
KC032	GRUPPO SCARICO SERBATOIO DISCHARGING GROUP	1
KC034	GRUPPO SCARICO DISCHARGING GROUP	1
KC114	MANICO A "U" HANDLE	1
KC276/VERDE	SERBATOIO 65 I RESERVOIR 65 I	1
KC293	COPPA RACCOGLI OLIO COLLECTING BASIN	1
KG001	RUBINETTO UNIVERSALE CARICA ARIA UNIVERSAL AIR TAP	1
KG079	GRUPPO GOMITO E GONFERA RING AND ELBOW JOINT GROUP	2
KG179	CONTENITORE PER 3 SONDE PROBES CONTAINER	1
KG180	SILENZIATORE COMPLETO COMPLETE MUFFLER	1
S104	VUOTOMETRO ø 60 mm VACUUM GAUGE ø 60 mm	1
S215	RUBINETTO A SFERA 1/4" BALL VALVE 1/4"	1
S402	VALVOLA DI SICUREZZA 1 bar SAFETY VALVE 1 bar	1

Art. KR4651 KIT GUARNIZIONI COMPLETO COMPOSTO DALLE GUARNIZIONI SOTTO ELENcate JOINTS GASKETS LIST INCLUDING ALL THE GASKETS SHOWN HERE UNDER		
CODICE CODE	DESCRIZIONE DESCRIPTION	Q.TÀ QTY
H034	O-RING 3156 O-RING 3156	1
H047	O-RING 2050 O-RING 2050	2
H052	O-RING 106 O-RING 106	2
H053	O-RING 2025 O-RING 2025	1
H054	O-RING 2018 O-RING 2018	3
H057	O-RING 2062 O-RING 2062	2
H059	O-RING 2037 O-RING 2037	5
H064	O-RING 3043 O-RING 3043	2
H086	O-RING 4118 O-RING 4118	4
H162	O-RING 3068 O-RING 3068	2
H202	O-RING 2043 O-RING 2043	2
H206	O-RING 3043 "VITON" O-RING 3043 "VITON"	1

Art. KS4681 SET RICAMBI CONSIGLIATI AI PUNTI VENDITA E ASSISTENZA, COMPOSTO DAI RICAMBI SOTTO ELENcati SPARE PARTS KIT ADVISED TO THE REPAIR CENTERS. THIS KIT INCLUDES ALL THE SPARE PARTS SHOWN HERE UNDER		
CODICE CODE	DESCRIZIONE DESCRIPTION	Q.TÀ QTY
KR4204	TUBO SCARICO CON FASCETTA STRINGI TUBO DISCHARGING HOSE WITH HOSE CLAMP	1
KR4302	TUBO ASPIRAZIONE COMPLETO COMPLETE SUCTION HOSE	1
KR4604	TUBO FLESSIBILE PER SERBATIO 65 I CONNECTING HOSE FOR 65 I RESERVOIR	1
KR4651	KIT GUARNIZIONI COMPLETO COMPLETE GASKETS KIT	1
S104	VUOTOMETRO ø 60 mm VACUUM GAUGE ø 60 mm	1



Art. 46114 Mod. R0.P. 115L



VISTA ESPLOSA - EXPLODED VIEW

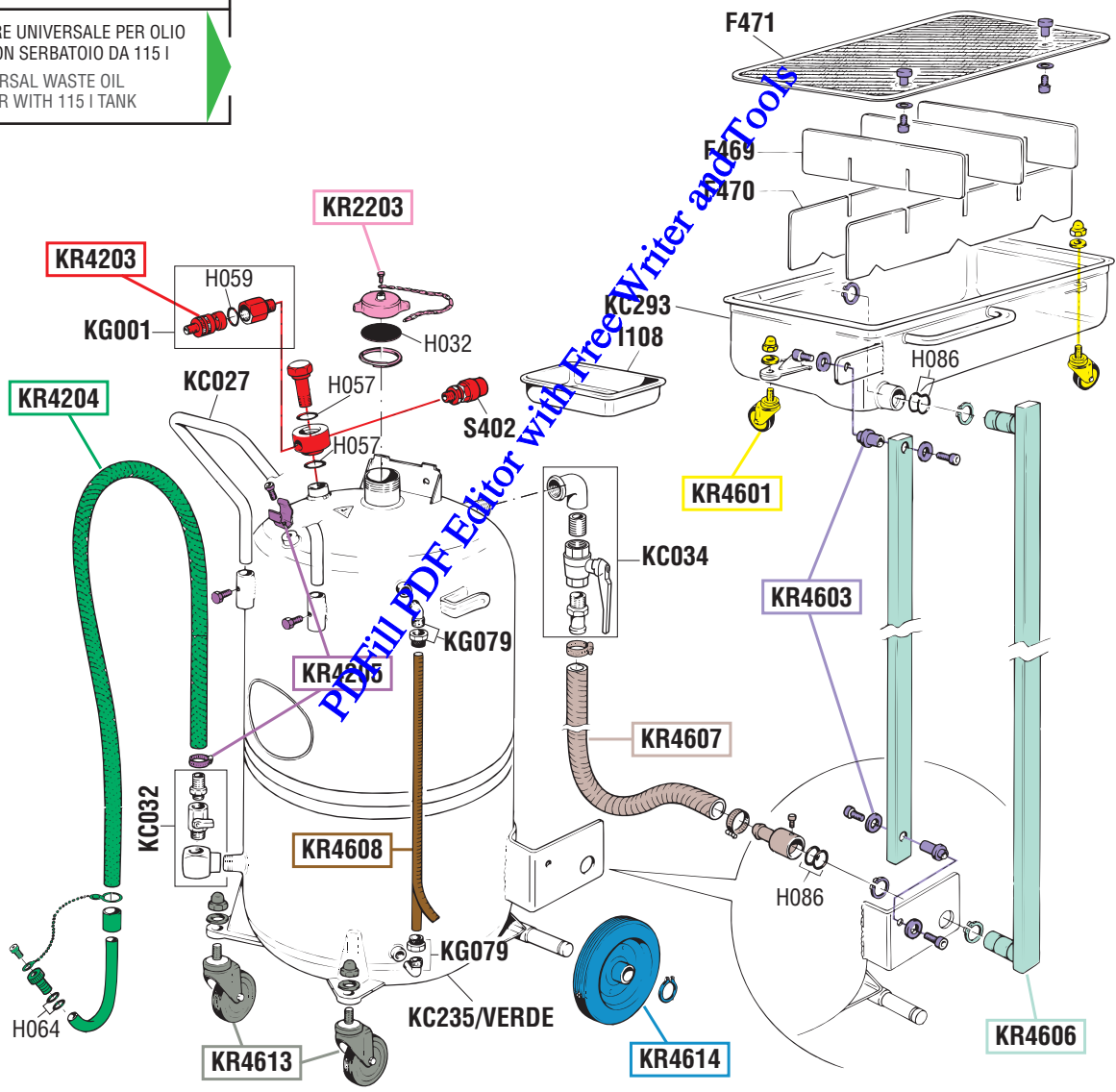

tutti i diritti riservati - all rights reserved

GUIDA RICAMBI - SPARE PARTS GUIDE

KIT RICAMBI OGNI KIT SOTTO RIPORTATO COMPRENDE I RICAMBI EVIDENZIATI CON LO STESSO COLORE E LE RELATIVE GUARNIZIONI. QUESTI RICAMBI NON SONO FORNIBILI SEPARATAMENTE TRANNE QUELLI CODIFICATI.		
SPARE PARTS KITS EACH KIT SHOWN WITH THE SAME COLOR INCLUDES ALSO THE GASKETS. THE SPARE PARTS INCLUDED IN THE KIT CAN'T BE SUPPLIED SEPARATELY EXCEPT THOSE SHOWN WITH A PROPER CODE.		
CODICE CODE	DESCRIZIONE DESCRIPTION	Q.TÀ QTY
KR2203	TAPPO ALTA PRESSIONE HIGH PRESSURE PLUG	1
KR4203	GRUPPO RUBINETTO-VALVOLA DI SICUREZZA AIR TAP AND SAFETY VALVE GROUP	1
KR4204	TUBO SCARICO CON FASCETTA STRINGI TUBO DISCHARGING HOSE WITH HOSE CLAMP	1
KR4205	SET DI VITI PER SERBATOIO SET OF SCREWS FOR RESERVOIR	1
KR4601	DUE RUOTE PIROETTANTI CON DADI TWO SWIVELLING WHEELS WITH NUTS	1
KR4603	SET VITI PER BRACCI PANTOGRAFO SET OF SCREWS FOR PANTOGRAPH ARMS	1
KR4606	KIT DUE BRACCI PER RECUP. A PANTOGRAFO TWO ARMS KIT FOR PANTOGRAPH DRAINER	1
KR4607	TUBO FLESSIBILE PER SERBATOIO 115 l CONNECTING HOSE FOR 115 l RESERVOIR	1
KR4608	TUBO LIVELLO CON ETICHETTA GAUGE TUBE WITH LABEL	1
KR4613	2 RUOTE PIROETTANTI CON FRENO - DADI 2 SWIVELLING WHEELS WITH BRAKE - NUTS	1
KR4614	2 RUOTE FISSE CON ANELLI ELASTICI 2 FIXED WHEELS WITH RETAINING RINGS	1

ELENCO RICAMBI FORNIBILI SINGOLARMENTE LIST OF SPARE PARTS WHICH CAN BE SUPPLIED SEPARATELY		
CODICE CODE	DESCRIZIONE DESCRIPTION	Q.TÀ QTY
I108	VASCHETTA PORTA OGGETTI TOOL TRAY	1
F469	FRANGIFLUTTO SPLASH RETAINER	3
F470	FRANGIFLUTTO SPLASH RETAINER	2
F471	GRIGLIA NET	1
KC027	MANICO A "U" HANDLE	1
KC032	GRUPPO SCARICO SERBATOIO DISCHARGING GROUP	1
KC034	GRUPPO SCARICO DISCHARGING GROUP	1
KC235/VERDE	SERBATOIO 115 l RESERVOIR 115 l	1
KC293	COPPA RACCOGLI OLIO COLLECTING BASIN	1
KG001	RUBINETTO UNIVERSALE CARICA ARIA UNIVERSAL AIR TAP	1
KG079	GRUPPO GOMITO E GHIERA RING AND ELBOW JOINT GROUP	2
S402	VALVOLA DI SICUREZZA 1 bar SAFETY VALVE 1 bar	1

Art. KR4650 KIT GUARNIZIONI COMPLETO COMPOSTO DALLE GUARNIZIONI SOTTO ELENCAE JOINTS GASKETS LIST INCLUDING ALL THE GASKETS SHOWN HERE UNDER		
CODICE CODE	DESCRIZIONE DESCRIPTION	Q.TÀ QTY
H032	GUARNIZIONE TAPPO GASKET	1
H057	O-RING 2062 O-RING 2062	2
H059	O-RING 2037 O-RING 2037	1
H064	O-RING 3043 O-RING 3043	2
H086	O-RING 4118 O-RING 4118	4
Art. KS4682 SET RICAMBI CONSIGLIATI AI PUNTI VENDITA E ASSISTENZA, COMPOSTO DAI RICAMBI SOTTO ELENCAE SPARE PARTS KIT ADVISED TO THE REPAIR CENTERS. THIS KIT INCLUDES ALL THE SPARE PARTS SHOWN HERE UNDER		
CODICE CODE	DESCRIZIONE DESCRIPTION	Q.TÀ QTY
KR4204	TUBO SCARICO CON FASCETTA STRINGI TUBO DISCHARGING HOSE WITH HOSE CLAMP	1
KR4607	TUBO FLESSIBILE PER SERBATIO 115 l CONNECTING HOSE FOR 115 l RESERVOIR	1
KR4650	KIT GUARNIZIONI COMPLETO COMPLETE GASKETS KIT	1

PDFfill PDF Editor with Free Writer and Tools



GUIDA RICAMBI - SPARE PARTS GUIDE

KIT RICAMBI OGNI KIT SOTTO RIPORTATO COMPRENDE I RICAMBI EVIDENZIATI CON LO STESSO COLORE E LE RELATIVE GUARNIZIONI. QUESTI RICAMBI NON SONO FORNIBILI SEPARATAMENTE TRANNE QUELLI CODIFICATI.		
SPARE PARTS KITS EACH KIT SHOWN WITH THE SAME COLOR INCLUDES ALSO THE GASKETS. THE SPARE PARTS INCLUDED IN THE KIT CAN'T BE SUPPLIED SEPARATELY EXCEPT THOSE SHOWN WITH A PROPER CODE.		
CODICE CODE	DESCRIZIONE DESCRIPTION	Q.TÀ QTY
KR4203	GRUPPO RUBINETTO-VALVOLA DI SICUREZZA AIR TAP AND SAFETY VALVE GROUP	1
KR4204	TUBO SCARICO CON FASCETTA STRINGI TUBO DISCHARGING HOSE WITH HOSE CLAMP	1
KR4205	SET DI VITI PER SERBATOIO SET OF SCREWS FOR RESERVOIR	1
KR4302	TUBO ASPIRAZIONE COMPLETO COMPLETE SUCTION HOSE	1
KR4304	GRUPPO ASPIRAZIONE CON RUBINETTO SUCTION GROUP WITH TAP	1
KR4601	DUE RUOTE PIROETTANTI CON DADI TWO SWIVELLING WHEELS WITH NUTS	1
KR4603	SET VITI PER BRACCI PANTOGRAFO SET OF SCREWS FOR PANTOGRAPH ARMS	1
KR4605	TAPPO RIDUTTORE ASPIRAZIONE SUCTION REDUCTION PLUG	1
KR4606	KIT DUE BRACCI PER RECUP. A PANTOGRAFO TWO ARMS KIT FOR PANTOGRAPH DRAINER	1
KR4607	TUBO FLESSIBILE PER SERBATOIO 115 l CONNECTING HOSE FOR 115 l RESERVOIR	1
KR4608	TUBO LIVELLO CON ETICHETTA GAUGE TUBE WITH LABEL	1
KR4613	2 RUOTE PIROETTANTI CON FRENO - DADI 2 SWIVELLING WHEELS WITH BRAKE - NUTS	1
KR4614	2 RUOTE FISSE CON ANELLI ELASTICI 2 FIXED WHEELS WITH RETAINING RINGS	1

ELENCO RICAMBI FORNIBILI SINGOLARMENTE LIST OF SPARE PARTS WHICH CAN BE SUPPLIED SEPARATELY		
CODICE CODE	DESCRIZIONE DESCRIPTION	Q.TÀ QTY
45500	RACCORDO PER SONDE (VOLKSWAGEN) CONNECTOR FOR PROBES (VOLKSWAGEN)	1
45501	RACCORDO PER SONDE (BMW) CONNECTOR FOR PROBES (BMW)	1
45502	RACCORDO PER SONDE (CITROEN) CONNECTOR FOR PROBES (CITROEN)	1
45504	SONDA ø 5 x 700 FLESSIBILE PROBE ø 5 x 700 FLEXIBLE	1
45505	SONDA ø 5 x 700 METALLO-MALLEABILE PROBE ø 5 x 700 MALLEABLE METAL	1
45506	SONDA ø 6 x 700 FLESSIBILE PROBE ø 6 x 700 FLEXIBLE	1
45516	SONDA ø 6 x 700 METALLO-MALLEABILE PROBE ø 6 x 700 MALLEABLE METAL	1
45517	SONDA ø 7 x 1000 FLESSIBILE PROBE ø 7 x 1000 FLEXIBLE	1
45518	SONDA ø 8 x 700 FLESSIBILE PROBE ø 8 x 700 FLEXIBLE	1
I108	VASCETTA PORTA OGGETTI TOOL TRAY	1
F469	FRANGIFLUTTO SPASH RETAINER	3
F470	FRANGIFLUTTO SPASH RETAINER	2
F471	GRIGLIA NET	1
KC027	MANICO A "U" HANDLE	1
KC032	GRUPPO SCARICO SERBATOIO DISCHARGING GROUP	1
KC034	GRUPPO SCARICO DISCHARGING GROUP	1
KC235/VERDE	SERBATOIO 115 l RESERVOIR 115 l	1
KC293	COPPA RACCOGLI OLIO COLLECTING BASIN	1
KG001	RUBINETTO UNIVERSALE CARICA ARIA UNIVERSAL AIR TAP	1
KG079	GRUPPO GOMITO E BIERA RING AND ELBOW JOINT GROUP	2
KG179	CONTENITORE PER SONDE PROBES CONTAINER	1
KG180	SILENZIATORE COMPLETO COMPLETE MUFFLER	1
S104	VUOTOMETRO ø 60 mm VACUUM GAUGE ø 60 mm	1
S215	RUBINETTO A SFERA 1/4" BALL VALVE 1/4"	1
S402	VALVOLA DI SICUREZZA 1 bar SAFETY VALVE 1 bar	1

Art. KR4651 KIT GUARNIZIONI COMPLETO COMPOSTO DALLE GUARNIZIONI SOTTO ELENCAE JOINTS GASKETS LIST INCLUDING ALL THE GASKETS SHOWN HERE UNDER		
CODICE CODE	DESCRIZIONE DESCRIPTION	Q.TÀ QTY
H034	O-RING 3156 O-RING 3156	1
H047	O-RING 2050 O-RING 2050	2
H052	O-RING 106 O-RING 106	2
H053	O-RING 2025 O-RING 2025	1
H054	O-RING 2018 O-RING 2018	3
H057	O-RING 2062 O-RING 2062	2
H059	O-RING 2037 O-RING 2037	5
H064	O-RING 3043 O-RING 3043	2
H086	O-RING 4118 O-RING 4118	4
H162	O-RING 3068 O-RING 3068	2
H202	O-RING 2043 O-RING 2043	2
H206	O-RING 3043 "VITON" O-RING 3043 "VITON"	1

Art. KS4683 SET RICAMBI CONSIGLIATI AI PUNTI VENDITA E ASSISTENZA, COMPOSTO DAI RICAMBI SOTTO ELENCAE SPARE PARTS KIT ADVISED TO THE REPAIR CENTERS. THIS KIT INCLUDES ALL THE SPARE PARTS SHOWN HERE UNDER		
CODICE CODE	DESCRIZIONE DESCRIPTION	Q.TÀ QTY
KR4204	TUBO SCARICO CON FASCETTA STRINGI TUBO DISCHARGING HOSE WITH HOSE CLAMP	1
KR4302	TUBO ASPIRAZIONE COMPLETO COMPLETE SUCTION HOSE	1
KR4607	TUBO FLESSIBILE PER SERBATOIO 115 l CONNECTING HOSE FOR 115 l RESERVOIR	1
KR4651	KIT GUARNIZIONI COMPLETO COMPLETE GASKETS KIT	1
S104	VUOTOMETRO ø 60 mm VACUUM GAUGE ø 60 mm	1



Art. 46116 Mod. R/AO.P. 115L



VISTA ESPLOSA - EXPLODED VIEW



RECUPERATORE-ASPIRATORE UNIVERSALE PER OLIO ESAUSTO CON SERBATOIO DA 115 L E PRECAMERA
AIR OPERATED UNIVERSAL OIL SUCTION-DRAINER WITH 115 L TANK AND PRECHAMBER

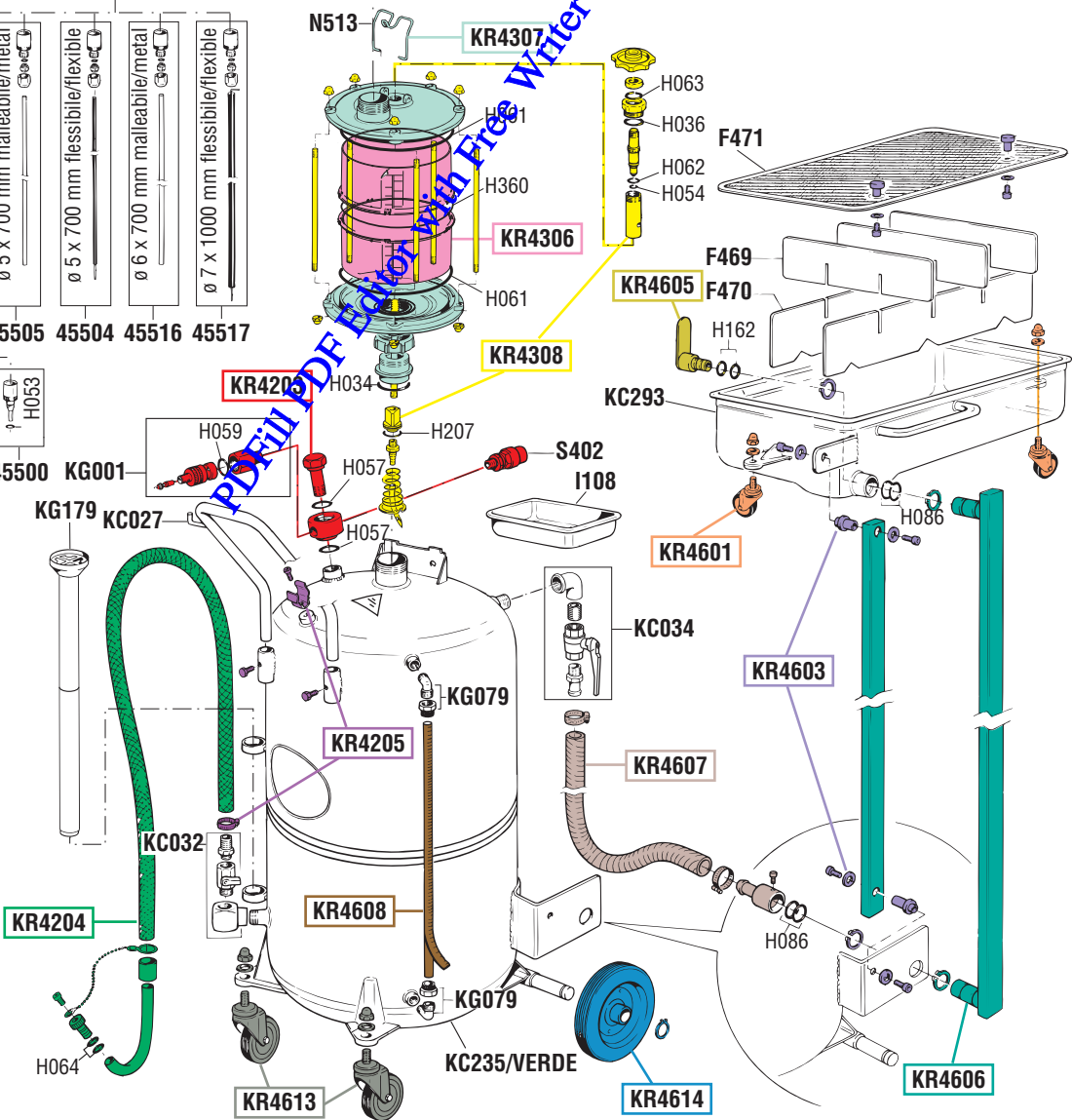
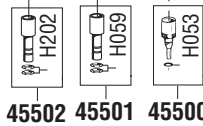
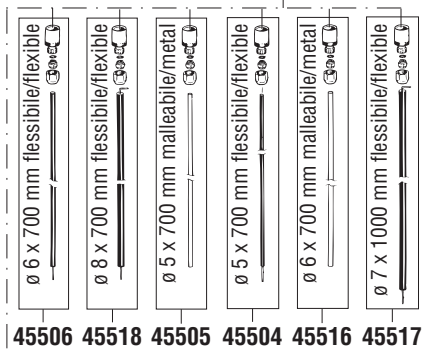
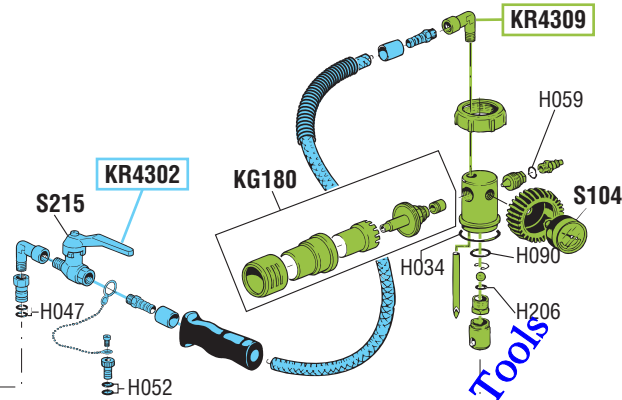

PDRILL DE Editor with Free Writer and Tools

tutti i diritti riservati - all rights reserved



GUIDA RICAMBI - SPARE PARTS GUIDE

KIT RICAMBI
OGNI KIT SOTTO RIPORTATO COMPRENDE I RICAMBI EVIDENZIATI CON LO STESSO COLORE E LE RELATIVE GUARNIZIONI. QUESTI RICAMBI NON SONO FORNIBILI SEPARATAMENTE TRANNE QUELLI CODIFICATI.

SPARE PARTS KITS

EACH KIT SHOWN WITH THE SAME COLOR INCLUDES ALSO THE GASKETS. THE SPARE PARTS INCLUDED IN THE KIT CAN'T BE SUPPLIED SEPARATELY EXCEPT THOSE SHOWN WITH A PROPER CODE.

CODICE CODE	DESCRIZIONE DESCRIPTION	Q. TÀ QTY
KR4203	GRUPPO RUBINETTO-VALVOLA DI SICUREZZA AIR TAP AND SAFETY VALVE GROUP	1
KR4204	TUBO SCARICO CON FASCETTA STRINGI TUBO DISCHARGING HOSE WITH HOSE CLAMP	1
KR4205	SET DI VITI PER SERBATOIO SET OF SCREWS FOR RESERVOIR	1
KR4302	TUBO ASPIRAZIONE COMPLETO COMPLETE SUCTION HOSE	1
KR4306	CILINDRO - 2 O-RING - ETICHETTA CYLINDER - 2 O-RING - LABEL	1
KR4307	DUE FLANGE PRECAMERA TWO TRANSPARENT BOWL FLANGES	1
KR4308	ACCESSORI PRECAMERA TRANSPARENT BOWL ACCESSORIES	1
KR4309	GRUPPO DEPRESSORE DEPRESSOR UNIT	1
KR4601	DUE RUOTE PIROETTANTI CON DADI TWO SWIVELING WHEELS WITH NUTS	1
KR4603	SET VITI PER BRACCI PANTOGRAFO SET OF SCREWS FOR PANTOGRAPH ARMS	1
KR4605	TAPPO RIDUTTORE ASPIRAZIONE SUCTION REDUCTION PLUG	1
KR4606	KIT DUE BRACCI PER RECUP. A PANTOGRAFO TWO ARMS KIT FOR PANTOGRAPH DRAINER	1
KR4607	TUBO FLESSIBILE PER SERBATOIO 115 l CONNECTING HOSE FOR 115 l RESERVOIR	1
KR4608	TUBO LIVELLO CON ETICHETTA GAUGE TUBE WITH LABEL	1
KR4613	2 RUOTE PIROETTANTI CON FRENO - DADI 2 SWIVELING WHEELS WITH BRAKE - NUTS	1
KR4614	2 RUOTE FISSE CON ANELLI ELASTICI 2 FIXED WHEELS WITH RETAINING RINGS	1

ELENCO RICAMBI FORNIBILI SINGOLARMENTE

LIST OF SPARE PARTS WHICH CAN BE SUPPLIED SEPARATELY

CODICE CODE	DESCRIZIONE DESCRIPTION	Q. TÀ QTY
45500	RACCORDO PER SONDE (VOLKSWAGEN) CONNECTOR FOR PROBES (VOLKSWAGEN)	1
45501	RACCORDO PER SONDE (BMW) CONNECTOR FOR PROBES (BMW)	1
45502	RACCORDO PER SONDE (CITROEN) CONNECTOR FOR PROBES (CITROEN)	1
45504	SONDA ø 5 x 700 FLESSIBILE PROBE ø 5 x 700 FLEXIBLE	1
45505	SONDA ø 5 x 700 METALLO-MALLEABILE PROBE ø 5 x 700 MALLEABLE METAL	1
45506	SONDA ø 6 x 700 FLESSIBILE PROBE ø 6 x 700 FLEXIBLE	1
45516	SONDA ø 6 x 700 METALLO-MALLEABILE PROBE ø 6 x 700 MALLEABLE METAL	1
45517	SONDA ø 7 x 1000 FLESSIBILE PROBE ø 7 x 1000 FLEXIBLE	1
45518	SONDA ø 8 x 700 FLESSIBILE PROBE ø 8 x 700 FLEXIBLE	1
I108	VASCHETTA PORTA OGGETTI TOOL TRAY	1
F469	FRANGIFLUTTO SPLASH RETAINER	3
F470	FRANGIFLUTTO SPLASH RETAINER	2
F471	GRIGLIA NET	1
KC027	MANICO A "U" HANDLE	1
KC032	GRUPPO SCARICO SERBATOIO DISCHARGING GROUP	1
KC034	GRUPPO SCARICO DISCHARGING GROUP	1
KC235/VERDE	SERBATOIO 115 l RESERVOIR 115 l	1
KC293	COPPA RACCOGLI OLIO COLLECTING BASIN	1
KG001	RUBINETTO UNIVERSALE CARICA ARIA UNIVERSAL AIR TAP	1
KG079	GRUPPO GOMITO E BUCHERA RING AND ELBOW JOINT GROUP	2
KG179	CONTENITORE PER SONDE PROBES CONTAINER	1
KG180	SILENZIATORE COMPLETO COMPLETE MUFFLER	1
N513	LEVA BILLOCA PULSANTE PRECAMERA PITCH NUMBER HOOKING LEVER	1
S104	VUOTOMETRO ø 60 mm VACUUM GAUGE ø 60 mm	1
S215	RUBINETTO A SFERA 1/4" BALL VALVE 1/4"	1
S402	VALVOLA DI SICUREZZA 1 bar SAFETY VALVE 1 bar	1

Art. KR4652
KIT GUARNIZIONI COMPLETO
COMPOSTO DALLE GUARNIZIONI SOTTO ELENCAE
JOINTS GASKETS LIST
INCLUDING ALL THE GASKETS SHOWN HERE UNDER

CODICE CODE	DESCRIZIONE DESCRIPTION	Q. TÀ QTY
H034	O-RING 3156 O-RING 3156	2
H036	O-RING 3093 O-RING 3093	1
H047	O-RING 2050 O-RING 2050	2
H052	O-RING 106 O-RING 106	2
H053	O-RING 2025 O-RING 2025	1
H054	O-RING 2018 O-RING 2018	1
H057	O-RING 2062 O-RING 2062	2
H059	O-RING 2037 O-RING 2037	4
H061	O-RING 4750 O-RING 4750	2
H062	O-RING 109 "NBR 70" O-RING 109 "NBR 70"	1
H063	O-RING 4081 O-RING 4081	1
H064	O-RING 3043 O-RING 3043	2
H086	O-RING 4118 O-RING 4118	4
H090	O-RING 3056 O-RING 3056	1
H162	O-RING 3068 O-RING 3068	2
H202	O-RING 2043 O-RING 2043	2
H206	O-RING 3043 "VITON" O-RING 3043 "VITON"	1
H207	O-RING 4093 "VITON" O-RING 4093 "VITON"	1
H360	O-RING 3775 "NBR 70" O-RING 3775 "NBR 70"	1

Art. KS4684
SET RICAMBI CONSIGLIATI
AI PUNTI VENDITA E ASSISTENZA,
COMPOSTO DAI RICAMBI SOTTO ELENCAE
SPARE PARTS KIT ADVISED
TO THE REPAIR CENTERS. THIS KIT INCLUDES
ALL THE SPARE PARTS SHOWN HERE UNDER

CODICE CODE	DESCRIZIONE DESCRIPTION	Q. TÀ QTY
KR4204	TUBO SCARICO CON FASCETTA STRINGI TUBO DISCHARGING HOSE WITH HOSE CLAMP	1
KR4302	TUBO ASPIRAZIONE COMPLETO COMPLETE SUCTION HOSE	1
KR4607	TUBO FLESSIBILE PER SERBATOIO 115 l CONNECTING HOSE FOR 115 l RESERVOIR	1
KR4652	KIT GUARNIZIONI COMPLETO COMPLETE GASKETS KIT	1
S104	VUOTOMETRO ø 60 mm VACUUM GAUGE ø 60 mm	1

RAASM

FLUIDS AND LUBRICATION EQUIPMENT



Art. 46215 Mod. R/AO.P. 215L



VISTA ESPLOSA - EXPLODED VIEW



RECUPERATORE-ASPIRATORE UNIVERSALE PER OLIO ESAUSTO CON SERBATOIO DA 115 l
AIR OPERATED UNIVERSAL OIL SUCTION-DRAINER WITH 115 l TANK

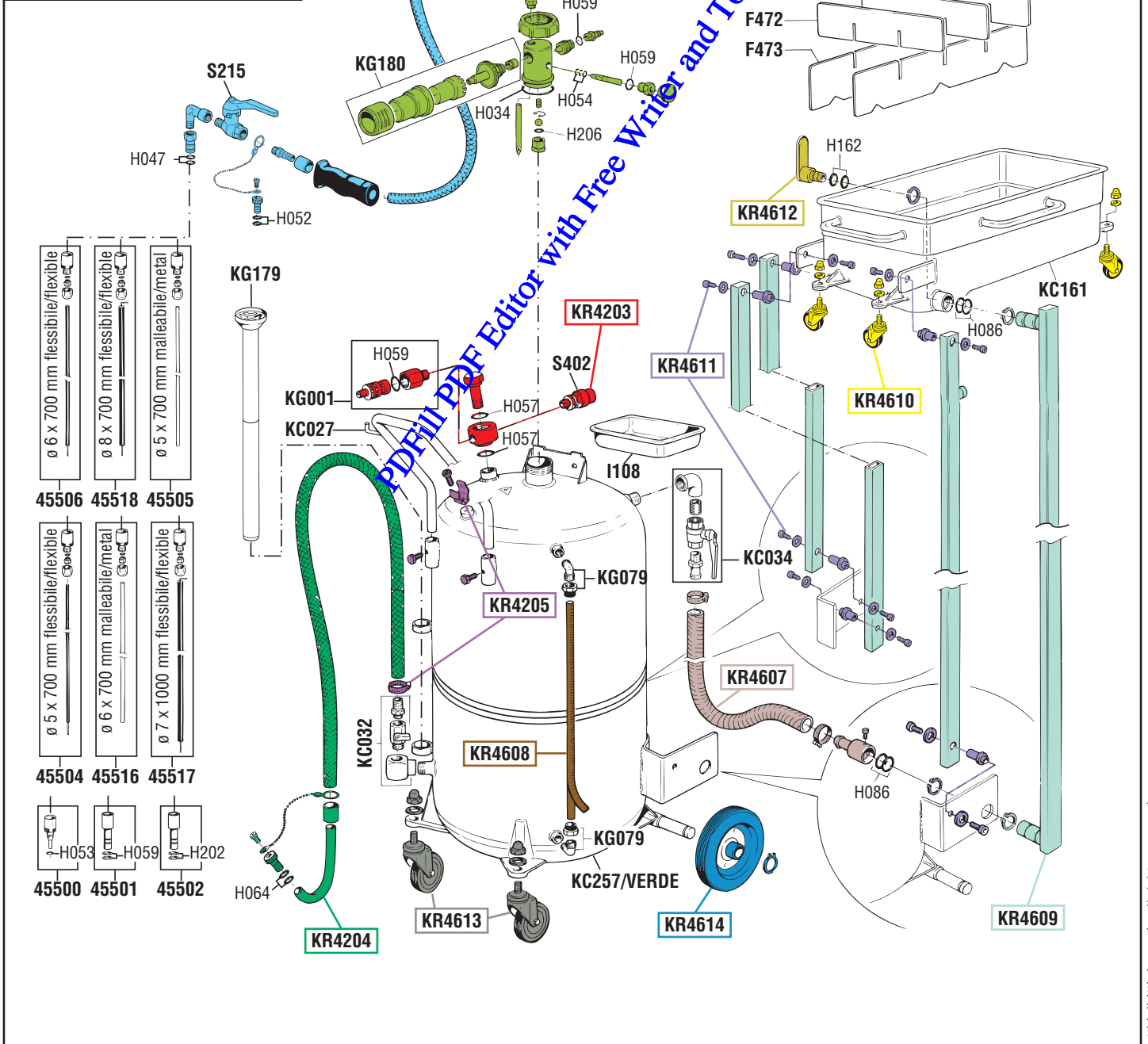

- ø 6 x 700 mm flessibile/flexible
- ø 8 x 700 mm flessibile/flexible
- ø 5 x 700 mm malleabile/metal

- ø 5 x 700 mm flessibile/flexible
- ø 6 x 700 mm malleabile/metal
- ø 7 x 1000 mm flessibile/flexible

- H053
- H059
- H202

tutti i diritti riservati - all rights reserved



GUIDA RICAMBI - SPARE PARTS GUIDE

KIT RICAMBI OGNI KIT SOTTO RIPORTATO COMPRENDE I RICAMBI EVIDENZIATI CON LO STESSO COLORE E LE RELATIVE GUARNIZIONI. QUESTI RICAMBI NON SONO FORNIBILI SEPARATAMENTE TRANNE QUELLI CODIFICATI.		
SPARE PARTS KITS EACH KIT SHOWN WITH THE SAME COLOR INCLUDES ALSO THE GASKETS. THE SPARE PARTS INCLUDED IN THE KIT CAN'T BE SUPPLIED SEPARATELY EXCEPT THOSE SHOWN WITH A PROPER CODE.		
CODICE CODE	DESCRIZIONE DESCRIPTION	Q.TÀ QTY
KR4203	GRUPPO RUBINETTO-VALVOLA DI SICUREZZA AIR TAP AND SAFETY VALVE GROUP	1
KR4204	TUBO SCARICO CON FASCETTA STRINGI TUBO DISCHARGING HOSE WITH HOSE CLAMP	1
KR4205	SET DI VITI PER SERBATOIO SET OF SCREWS FOR RESERVOIR	1
KR4302	TUBO ASPIRAZIONE COMPLETO COMPLETE SUCTION HOSE	1
KR4304	GRUPPO ASPIRAZIONE CON RUBINETTO SUCTION GROUP WITH TAP	1
KR4607	TUBO FLESSIBILE PER SERBATOIO 115 l CONNECTING HOSE FOR 115 l RESERVOIR	1
KR4608	TUBO LIVELLO CON ETICHETTA GAUGE TUBE WITH LABEL	1
KR4609	KIT QUATTRO BRACCIA PER RECUP. A PANTOG. FOUR ARMS KIT FOR PANTOGRAPH DRAINER	1
KR4610	4 RUOTE PIROETTANTI ø 60 mm - DADI 4 SWIVELING WHEELS ø 60 mm - NUTS	1
KR4611	SET VITI PER BRACCI PANTOGRAFO SET OF SCREWS FOR PANTOGRAPH ARMS	1
KR4612	TAPPO RIDUTTORE ASPIRAZIONE CAMION SUCTION REDUCING PLUG FOR TRUCK	1
KR4613	2 RUOTE PIROETTANTI CON FRENO - DADI 2 SWIVELLING WHEELS WITH BRAKE - NUTS	1
KR4614	2 RUOTE FISSE CON ANELLI ELASTICI 2 FIXED WHEELS WITH RETAINING RINGS	1

ELENCO RICAMBI FORNIBILI SINGOLARMENTE LIST OF SPARE PARTS WHICH CAN BE SUPPLIED SEPARATELY		
CODICE CODE	DESCRIZIONE DESCRIPTION	Q.TÀ QTY
45500	RACCORDO PER SONDE (VOLKSWAGEN) CONNECTOR FOR PROBES (VOLKSWAGEN)	1
45501	RACCORDO PER SONDE (BMW) CONNECTOR FOR PROBES (BMW)	1
45502	RACCORDO PER SONDE (CITROEN) CONNECTOR FOR PROBES (CITROEN)	1
45504	SONDA ø 5 x 700 FLESSIBILE PROBE ø 5 x 700 FLEXIBLE	1
45505	SONDA ø 5 x 700 METALLO-MALLEABILE PROBE ø 5 x 700 MALLEABLE METAL	1
45506	SONDA ø 6 x 700 FLESSIBILE PROBE ø 6 x 700 FLEXIBLE	1
45516	SONDA ø 6 x 700 METALLO-MALLEABILE PROBE ø 6 x 700 MALLEABLE METAL	1
45517	SONDA ø 7 x 1000 FLESSIBILE PROBE ø 7 x 1000 FLEXIBLE	1
45518	SONDA ø 8 x 700 FLESSIBILE PROBE ø 8 x 700 FLEXIBLE	1
I108	VASCETTA PORTA OGGETTI TOOL TRAY	1
F472	FRANGIFLUTTO SPASH RETAINER	3
F473	FRANGIFLUTTO SPASH RETAINER	2
F474	GRIGLIA NET	1
KC027	MANICO A "U" HANDLE	1
KC032	GRUPPO SCARICO SERBATOIO DISCHARGING GROUP	1
KC034	GRUPPO SCARICO DISCHARGING GROUP	1
KC161	COPPA RACCOGLI OLIO COLLECTING BASIN	1
KC257/VERDE	SERBATOIO 115 l RESERVOIR 115 l	1
KG001	RUBINETTO UNIVERSALE CARICA ARIA UNIVERSAL AIR TAP	1
KG079	GRUPPO GOMITO E BIERA RING AND ELBOW JOINT GROUP	2
KG179	CONTENITORE PER SONDE PROBES CONTAINER	1
KG180	SILENZIATORE COMPLETO COMPLETE MUFFLER	1
S104	VUOTOMETRO ø 60 mm VACUUM GAUGE ø 60 mm	1
S215	RUBINETTO A SFERA 1/4" BALL VALVE 1/4"	1
S402	VALVOLA DI SICUREZZA 1 bar SAFETY VALVE 1 bar	1

Art. KR4651 KIT GUARNIZIONI COMPLETO COMPOSTO DALLE GUARNIZIONI SOTTO ELENCAE JOINTS GASKETS LIST INCLUDING ALL THE GASKETS SHOWN HERE UNDER		
CODICE CODE	DESCRIZIONE DESCRIPTION	Q.TÀ QTY
H034	O-RING 3156 O-RING 3156	1
H047	O-RING 2050 O-RING 2050	2
H052	O-RING 106 O-RING 106	2
H053	O-RING 2025 O-RING 2025	1
H054	O-RING 2018 O-RING 2018	3
H057	O-RING 2062 O-RING 2062	2
H059	O-RING 2037 O-RING 2037	4
H064	O-RING 3043 O-RING 3043	2
H086	O-RING 4118 O-RING 4118	4
H162	O-RING 3068 O-RING 3068	2
H202	O-RING 2043 O-RING 2043	2
H206	O-RING 3043 "VITON" O-RING 3043 "VITON"	1

Art. KS4683 SET RICAMBI CONSIGLIATI AI PUNTI VENDITA E ASSISTENZA, COMPOSTO DAI RICAMBI SOTTO ELENCAE SPARE PARTS KIT ADVISED TO THE REPAIR CENTERS. THIS KIT INCLUDES ALL THE SPARE PARTS SHOWN HERE UNDER		
CODICE CODE	DESCRIZIONE DESCRIPTION	Q.TÀ QTY
KR4204	TUBO SCARICO CON FASCETTA STRINGI TUBO DISCHARGING HOSE WITH HOSE CLAMP	1
KR4302	TUBO ASPIRAZIONE COMPLETO COMPLETE SUCTION HOSE	1
KR4607	TUBO FLESSIBILE PER SERBATIO 115 l CONNECTING HOSE FOR 115 l RESERVOIR	1
KR4651	KIT GUARNIZIONI COMPLETO COMPLETE GASKETS KIT	1
S104	VUOTOMETRO ø 60 mm VACUUM GAUGE ø 60 mm	1



Art. 52010 Mod. 20 AR. 11M



VISTA ESPLOSA - EXPLODED VIEW

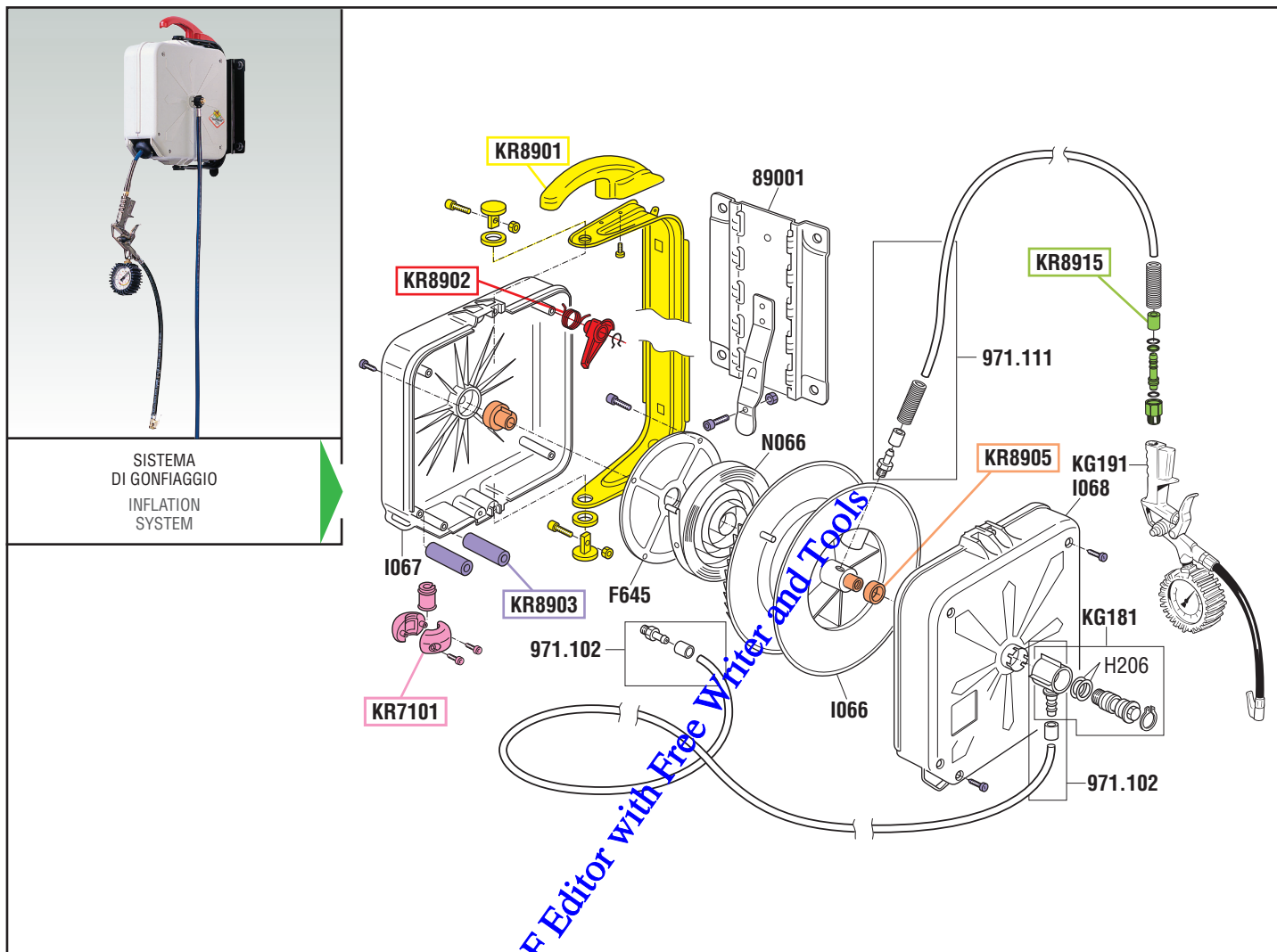

tutti i diritti riservati - all rights reserved

GUIDA RICAMBI - SPARE PARTS GUIDE

KIT RICAMBI

OGNI KIT SOTTO RIPORTATO COMPRENDE I RICAMBI EVIDENZIATI CON LO STESSO COLORE E LE RELATIVE GUARNIZIONI. QUESTI RICAMBI NON SONO FORNIBILI SEPARATAMENTE TRAMIE QUELLI CODIFICATI.

SPARE PARTS KITS

EACH KIT SHOWN WITH THE SAME COLOR INCLUDES ALSO THE GASKETS. THE SPARE PARTS INCLUDED IN THE KIT CAN'T BE SUPPLIED SEPARATELY EXCEPT THOSE SHOWN WITH A PROPER CODE.

CODICE CODE	DESCRIZIONE DESCRIPTION	Q.TÀ QTY
KR7101	TAMPONE FERMATUBO HOSE STOP	1
KR8901	SUPPORTO AVVOLGITUBO ORIENTABILE ADJUSTABLE BRACKET	1
KR8902	DENTE D'ARRESTO DETENT	1
KR8903	SET VITI AVVOLGITUBO HOSEREEL SCREWS KIT	1
KR8905	KIT BOCCOLE PERNO BUSH KIT PIN	1
KR8915	KIT SNODO TUBO POLIURETANO POLYURETHANE SWIVEL HOSE KIT	1

ELENCO RICAMBI FORNIBILI SINGOLARMENTE

LIST OF SPARE PARTS WHICH CAN BE SUPPLIED SEPARATELY

CODICE CODE	DESCRIZIONE DESCRIPTION	Q.TÀ QTY
89001	STAFFA MURALE WALL BRACKET	1
F645	CARTER COVER	1
H206	O-RING 3043 "VITON" O-RING 3043 "VITON"	2
I066	TAMBURO DRUM	1
I067	CARTER COVER	1
I068	CARTER COVER	1
971.102	SPEZZONE TUBO 1,5 m HOSE SECTION 1,5 m	1
971.111	TUBO "POLIURETANO" 8 x 12 - 11 m "POLYURETHANE" HOSE 8 x 12 - 11 m	1
KG181	SNODO AVVOLGITUBO HOSEREEL JOINT	1
KG191	PISTOLA GONFIAGGIO INFLATING GUN	1
N066	MOLLA DI CARICA SPRING	1



Art. 52015 Mod. GG.P.13L - Art. 53016 Mod. GG.P.O.13L

VISTA ESPLOSA - EXPLODED VIEW

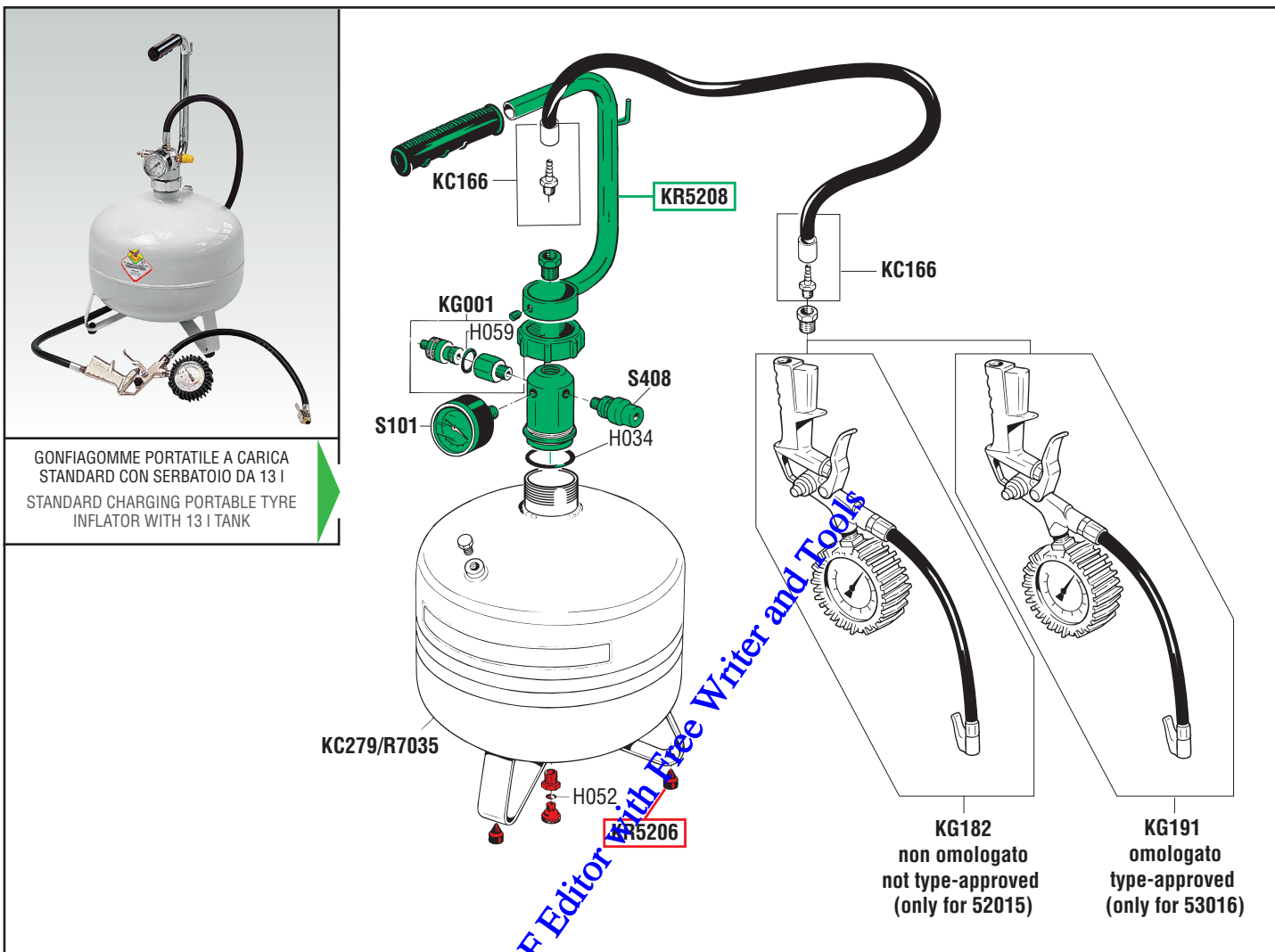

GONFIAGOMME PORTATILE A CARICA STANDARD CON SERBATOIO DA 13 l
STANDARD CHARGING PORTABLE TYRE INFLATOR WITH 13 l TANK

KG182 non omologato not type-approved (only for 52015)
KG191 omologato type-approved (only for 53016)

tutti i diritti riservati - all rights reserved

GUIDA RICAMBI - SPARE PARTS GUIDE

KIT RICAMBI
OGNI KIT SOTTO RIPORTATO COMPRENDE I RICAMBI EVIDENZIATI CON LO STESSO COLORE E LE RELATIVE GUARNIZIONI. QUESTI RICAMBI NON SONO FORNIBILI SEPARATAMENTE TRANNE QUELLI CODIFICATI.

SPARE PARTS KITS
EACH KIT SHOWN WITH THE SAME COLOR INCLUDES ALSO THE GASKETS. THE SPARE PARTS INCLUDED IN THE KIT CAN'T BE SUPPLIED SEPARATELY EXCEPT THOSE SHOWN WITH A PROPER CODE.

CODICE CODE	DESCRIZIONE DESCRIPTION	Q.TÀ QTY
KR5206	ACCESSORI SERBATOIO RESERVOIR ACCESSORIES	1
KR5208	CORPO PRINCIPALE MAIN BODY	1

ELENCO RICAMBI FORNIBILI SINGOLARMENTE
LIST OF SPARE PARTS WHICH CAN BE SUPPLIED SEPARATELY

CODICE CODE	DESCRIZIONE DESCRIPTION	Q.TÀ QTY
KC166	TUBO COLLEGAMENTO CONNECTING HOSE	1
KC279/R7035	SERBATOIO GONFIAGOMME TYRE INFLATOR RESERVOIR	1
KG001	RUBINETTO UNIVERSALE CARICA ARIA UNIVERSAL AIR TAP	1
KG182	PISTOLA GONFIAGGIO INFLATING GUN	1
KG191	PISTOLA GONFIAGGIO INFLATING GUN	1
S101	MANOMETRO ø 50 mm GAUGE ø 50 mm	1
S408	VALVOLA SICUREZZA 10 bar SAFETY VALVE 10 bar	1

Art. KR5251 KIT GUARNIZIONI COMPLETO
COMPOSTO DALLE GUARNIZIONI SOTTO ELENCAE JOINTS GASKETS LIST INCLUDING ALL THE GASKETS SHOWN HERE UNDER

CODICE CODE	DESCRIZIONE DESCRIPTION	Q.TÀ QTY
H034	O-RING 3156 O-RING 3156	1
H052	O-RING 106 O-RING 106	1
H059	O-RING 2037 O-RING 2037	1

Art. KS5281 SET RICAMBI CONSIGLIATI
AI PUNTI VENDITA E ASSISTENZA, COMPOSTO DAI RICAMBI SOTTO ELENCAE TO THE REPAIR CENTERS. THIS KIT INCLUDES ALL THE SPARE PARTS SHOWN HERE UNDER

SPARE PARTS KIT ADVISED

CODICE CODE	DESCRIZIONE DESCRIPTION	Q.TÀ QTY
KR5251	KIT GUARNIZIONI COMPLETO COMPLETE GASKETS KIT	1
S101	MANOMETRO ø 50 mm GAUGE ø 50 mm	1



Art. 52024 Mod. GG.P.24L - Art. 53024 Mod. GG.P.O.24L

VISTA ESPLOSA - EXPLODED VIEW



GONFIAGOMME CARRELLATO A CARICA STANDARD CON SERBATOIO DA 24 l
STANDARD CHARGING WHEEL-MOUNTED TYRE INFLATOR WITH 24 l TANK

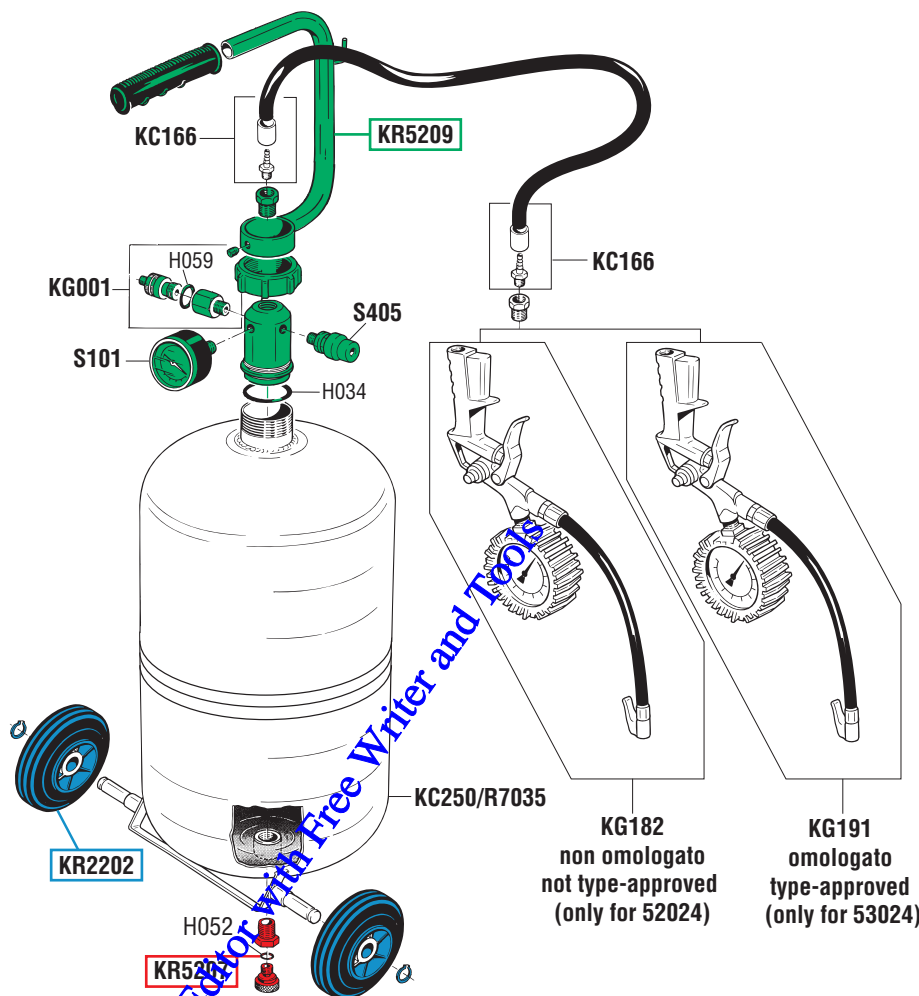

GUIDA RICAMBI - SPARE PARTS GUIDE

KIT RICAMBI
OGNI KIT SOTTO RIPORTATO COMPRENDE I RICAMBI EVIDENZIATI CON LO STESSO COLORE E LE RELATIVE GUARNIZIONI. QUESTI RICAMBI NON SONO FORNIBILI SEPARATAMENTE TRANNE QUELLI CODIFICATI.

SPARE PARTS KITS
EACH KIT SHOWN WITH THE SAME COLOR INCLUDES ALSO THE GASKETS. THE SPARE PARTS INCLUDED IN THE KIT CAN'T BE SUPPLIED SEPARATELY EXCEPT THOSE SHOWN WITH A PROPER CODE.

CODICE CODE	DESCRIZIONE DESCRIPTION	Q.TÀ QTY
KR2202	DUE RUOTE FISSE CON ANELLI ELASTICI TWO FIXED WHEELS WITH RETAINING RINGS	1
KR5207	VALVOLA DI SCARICO CONDENSA CONDENSATE DISCHARGE VALVE	1
KR5209	CORPO PRINCIPALE MAIN BODY	1

ELENCO RICAMBI FORNIBILI SINGOLARMENTE
LIST OF SPARE PARTS WHICH CAN BE SUPPLIED SEPARATELY

CODICE CODE	DESCRIZIONE DESCRIPTION	Q.TÀ QTY
KC166	TUBO COLLEGAMENTO CONNECTING HOSE	1
KC250/R7035	SERBATOIO GONFIAGOMME TYRE INFLATOR RESERVOIR	1
KG001	RUBINETTO UNIVERSALE CARICA ARIA UNIVERSAL AIR TAP	1
KG182	PISTOLA GONFIAGGIO INFLATING GUN	1
KG191	PISTOLA GONFIAGGIO INFLATING GUN	1
S101	MANOMETRO ø 50 mm GAUGE ø 50 mm	1
S405	VALVOLA SICUREZZA 8 bar SAFETY VALVE 8 bar	1

Art. KR5251 **KIT GUARNIZIONI COMPLETO**
COMPOSTO DALLE GUARNIZIONI SOTTO ELENCAE
JOINTS GASKETS LIST
INCLUDING ALL THE GASKETS SHOWN HERE UNDER

CODICE CODE	DESCRIZIONE DESCRIPTION	Q.TÀ QTY
H034	O-RING 3156 O-RING 3156	1
H052	O-RING 106 O-RING 106	1
H059	O-RING 2037 O-RING 2037	1

Art. KS5281 **SET RICAMBI CONSIGLIATI**
AI PUNTI VENDITA E ASSISTENZA,
COMPOSTO DAI RICAMBI SOTTO ELENCAE
SPARE PARTS KIT ADVISED
TO THE REPAIR CENTERS. THIS KIT INCLUDES
ALL THE SPARE PARTS SHOWN HERE UNDER

CODICE CODE	DESCRIZIONE DESCRIPTION	Q.TÀ QTY
KR5251	KIT GUARNIZIONI COMPLETO COMPLETE GASKETS KIT	1
S101	MANOMETRO ø 50 mm GAUGE ø 50 mm	1

tutti i diritti riservati - all rights reserved



Art. 60280 - Art. 60310 - Art. 60311



VISTA ESPLOSA - EXPLODED VIEW



INGRASSATORE MANUALE, PORTATILE
PER FUSTI DA 12 - 30 Kg
PORTABLE HAND-OPERATED GREASE
PUMP FOR DRUMS OF 12 - 30 Kg

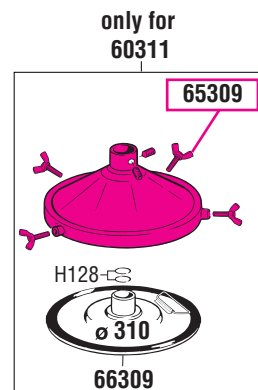
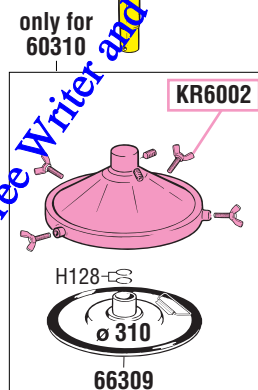
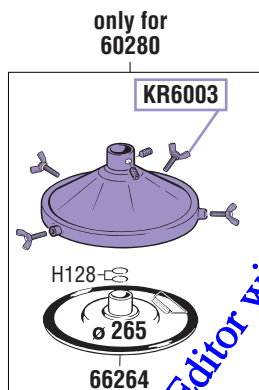
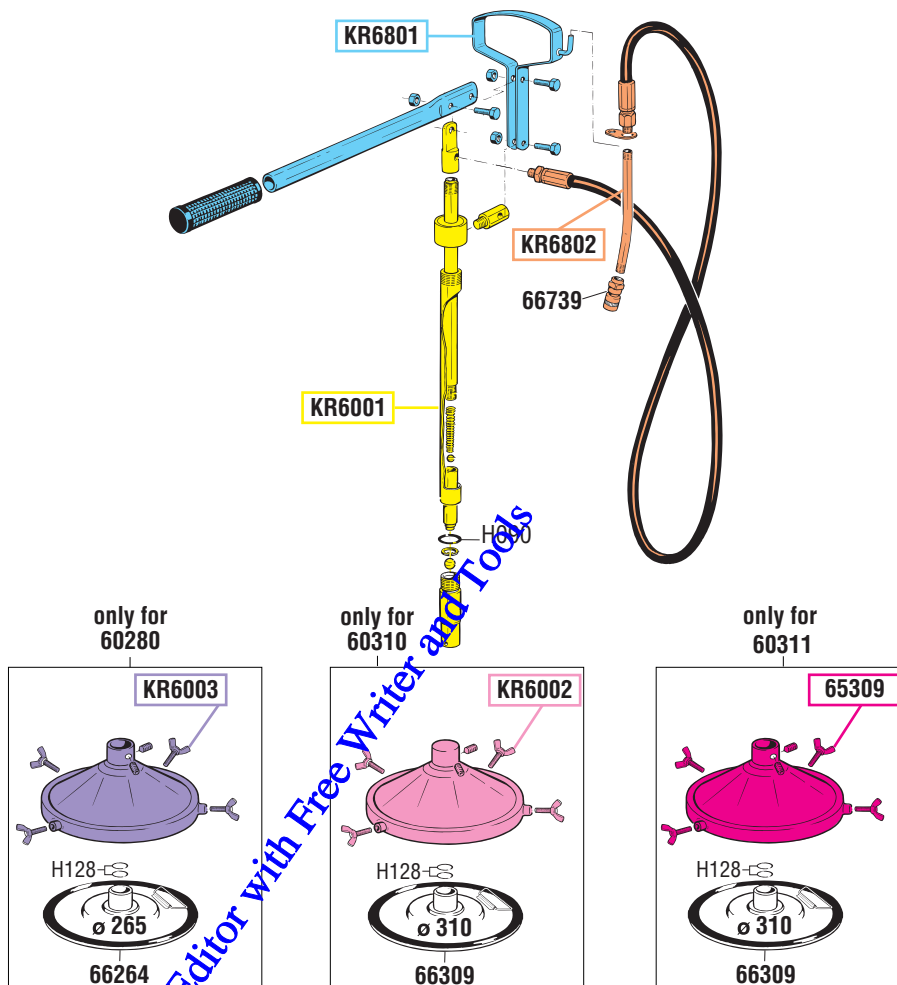

GUIDA RICAMBI - SPARE PARTS GUIDE

KIT RICAMBI
OGNI KIT SOTTO RIPORTATO COMPRENDE I RICAMBI EVIDENZIATI CON LO STESSO COLORE E LE RELATIVE GUARNIZIONI. QUESTI RICAMBI NON SONO FORNIBILI SEPARATAMENTE TRANNE QUELLI CODIFICATI.

SPARE PARTS KITS
EACH KIT SHOWN WITH THE SAME COLOR INCLUDES ALSO THE GASKETS. THE SPARE PARTS INCLUDED IN THE KIT CAN'T BE SUPPLIED SEPARATELY EXCEPT THOSE SHOWN WITH A PROPER CODE.

CODICE CODE	DESCRIZIONE DESCRIPTION	Q.TÀ QTY
KR6001	POMPA GRASSO MANUALE MANUAL GREASE PUMP	1
KR6002	COPRIFUSTO ø 310 mm COVER ø 310 mm	1
KR6003	COPRIFUSTO ø 280 mm COVER ø 280 mm	1
65309	COPRIFUSTO ø 337 mm COVER ø 337 mm	1
KR6801	ACCESSORI MANICO E LEVA HANDLE ACCESSORIES AND LEVER	1
KR6802	TUBO EROGAZIONE COMPLETO COMPLETE GREASE DELIVERY HOSE	1

ELENCO RICAMBI FORNIBILI SINGOLARMENTE
LIST OF SPARE PARTS WHICH CAN BE SUPPLIED SEPARATELY

CODICE CODE	DESCRIZIONE DESCRIPTION	Q.TÀ QTY
66264	MEMBRANA ø 265 mm FOLLOWER PLATE ø 265 mm	1
66309	MEMBRANA ø 310 mm FOLLOWER PLATE ø 310 mm	1
66739	TESTINA DI INGRASSAGGIO 4 JAWS GREASE FITTING	1

Art. KR6850 **KIT GUARNIZIONI COMPLETO**
COMPOSTO DALLE GUARNIZIONI SOTTO ELENCATE
JOINTS GASKETS LIST
INCLUDING ALL THE GASKETS SHOWN HERE UNDER

CODICE CODE	DESCRIZIONE DESCRIPTION	Q.TÀ QTY
H090	O-RING 3056 O-RING 3056	1
H128	O-RING 4100 O-RING 4100	2

Art. KS6880 **SET RICAMBI CONSIGLIATI**
AI PUNTI VENDITA E ASSISTENZA,
COMPOSTO DAI RICAMBI SOTTO ELENCA TI
SPARE PARTS KIT ADVISED
TO THE REPAIR CENTERS. THIS KIT INCLUDES
ALL THE SPARE PARTS SHOWN HERE UNDER

CODICE CODE	DESCRIZIONE DESCRIPTION	Q.TÀ QTY
KR6802	TUBO EROGAZIONE COMPLETO COMPLETE GREASE DELIVERY HOSE	1
KR6850	KIT GUARNIZIONI COMPLETO COMPLETE GASKETS KIT	1

tutti i diritti riservati - all rights reserved



Art. 60410 - Art. 60411



VISTA ESPLOSA - EXPLODED VIEW

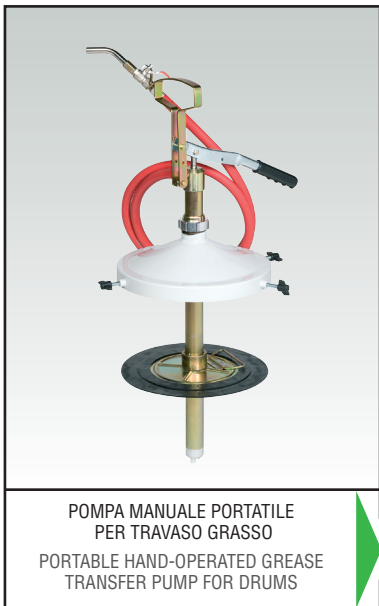

POMPA MANUALE PORTATILE PER TRAVASO GRASSO
PORTABLE HAND-OPERATED GREASE TRANSFER PUMP FOR DRUMS

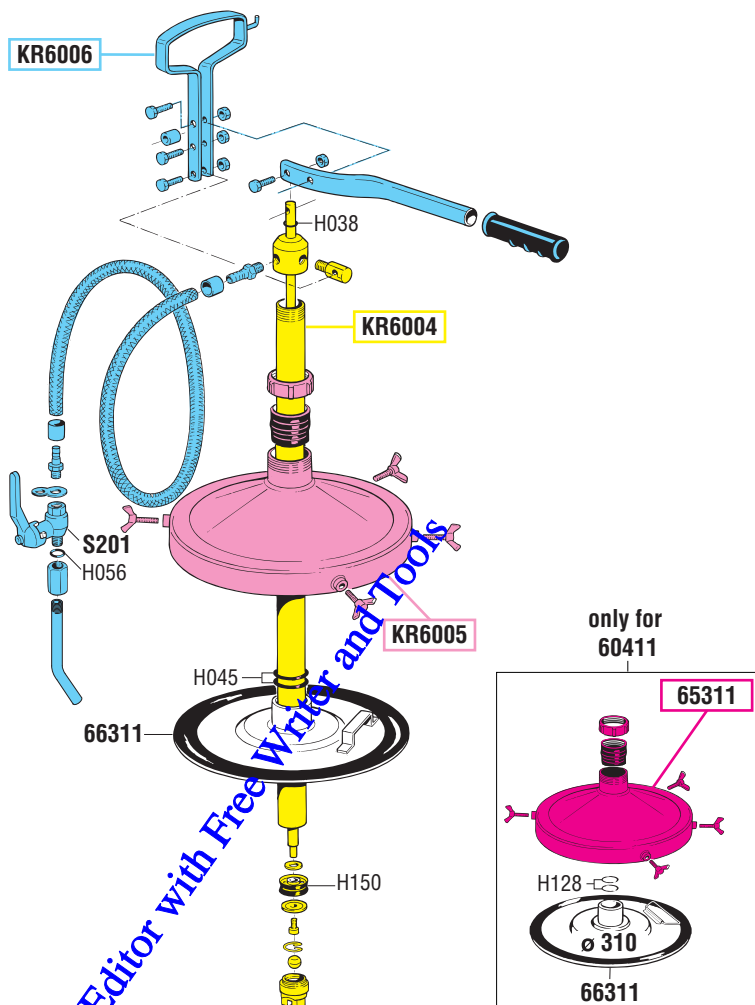

tutti i diritti riservati - all rights reserved

GUIDA RICAMBI - SPARE PARTS GUIDE

KIT RICAMBI
OGNI KIT SOTTO RIPIRTATO COMPRENDE I RICAMBI EVIDENZIATI CON LO STESSO COLORE E LE RELATIVE GUARNIZIONI. QUESTI RICAMBI NON SONO FORNIBILI SEPARATAMENTE TRANNE QUELLI CODIFICATI.

SPARE PARTS KITS
EACH KIT SHOWN WITH THE SAME COLOR INCLUDES ALSO THE GASKETS. THE SPARE PARTS INCLUDED IN THE KIT CAN'T BE SUPPLIED SEPARATELY EXCEPT THOSE SHOWN WITH A PROPER CODE.

CODICE CODE	DESCRIZIONE DESCRIPTION	Q.TÀ QTY
KR6004	POMPA GRASSO MANUALE MANUAL GREASE PUMP	1
KR6005	COPRIFUSTO ø 310 mm COVER ø 310 mm	1
KR6006	ACCESSORI MANICO - TUBO HANDLE ACCESSORIES - HOSE	1
65311	COPRIFUSTO ø 337 mm COVER ø 337 mm	1

ELENCO RICAMBI FORNIBILI SINGOLARMENTE
LIST OF SPARE PARTS WHICH CAN BE SUPPLIED SEPARATELY

CODICE CODE	DESCRIZIONE DESCRIPTION	Q.TÀ QTY
66311	MEMBRANA INGRASSATORE MANUALE FOLLOWER PLATE OF MANUAL PUMP	1
S201	RUBINETTO A SFERA 1/4" BALL VALVE 1/4"	1

Art. KR6852 **KIT GUARNIZIONI COMPLETO**
COMPOSTO DALLE GUARNIZIONI SOTTO ELENCAE
JOINTS GASKETS LIST
INCLUDING ALL THE GASKETS SHOWN HERE UNDER

CODICE CODE	DESCRIZIONE DESCRIPTION	Q.TÀ QTY
H038	O-RING 115 O-RING 115	1
H045	O-RING 4150 O-RING 4150	2
H056	O-RING 114 O-RING 114	1
H128	O-RING 4100 O-RING 4100	2
H150	GUARNIZIONE GASKET	1



Art. 61280 - Art. 61310 - Art. 61311

VISTA ESPLOSA - EXPLODED VIEW



INGRASSATORE MANUALE, CARRELLATO PER FUSTI DA 12 - 30 Kg
HAND-OPERATED GREASE PUMP FOR DRUMS OF 12 - 30 Kg

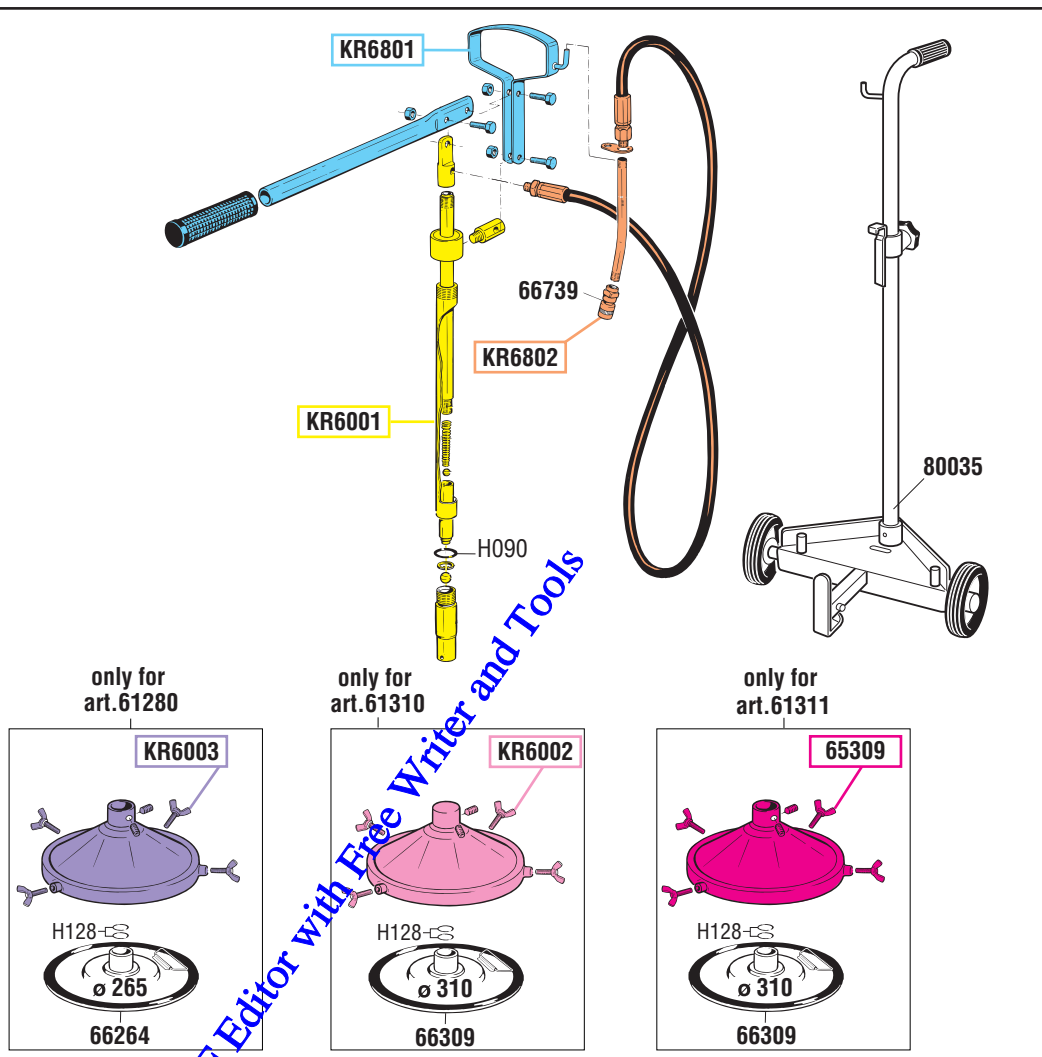

only for art.61280

only for art.61310

only for art.61311

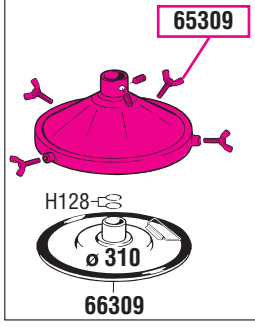
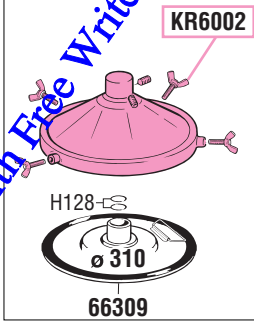
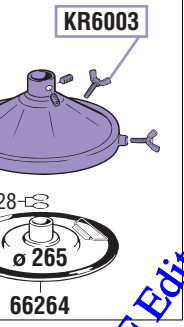

tutti i diritti riservati - all rights reserved

GUIDA RICAMBI - SPARE PARTS GUIDE

KIT RICAMBI
OGNI KIT SOTTO RIPORTATO COMPRENDE I RICAMBI EVIDENZIATI CON LO STESSO COLORE E LE RELATIVE GUARNIZIONI. QUESTI RICAMBI NON SONO FORNIBILI SEPARATAMENTE TRANNE QUELLI CODIFICATI.

SPARE PARTS KITS
EACH KIT SHOWN WITH THE SAME COLOR INCLUDES ALSO THE GASKETS. THE SPARE PARTS INCLUDED IN THE KIT CAN'T BE SUPPLIED SEPARATELY EXCEPT THOSE SHOWN WITH A PROPER CODE.

CODICE CODE	DESCRIZIONE DESCRIPTION	Q.TÀ QTY
KR6001	POMPA GRASSO MANUALE MANUAL GREASE PUMP	1
KR6002	COPRIFUSTO ø 310 mm COVER ø 310 mm	1
KR6003	COPRIFUSTO ø 280 mm COVER ø 280 mm	1
65309	COPRIFUSTO ø 337 mm COVER ø 337 mm	1
KR6801	ACCESSORI MANICO E LEVA HANDLE ACCESSORIES AND LEVER	1
KR6802	TUBO EROGAZIONE COMPLETO COMPLETE GREASE DELIVERY HOSE	1

ELENCO RICAMBI FORNIBILI SINGOLARMENTE
LIST OF SPARE PARTS WHICH CAN BE SUPPLIED SEPARATELY

CODICE CODE	DESCRIZIONE DESCRIPTION	Q.TÀ QTY
66264	MEMBRANA ø 265 mm FOLLOWER PLATE ø 265 mm	1
66309	MEMBRANA ø 310 mm FOLLOWER PLATE ø 310 mm	1
66739	TESTINA DI INGRASSAGGIO 4 JAWS GREASE FITTING	1
80035	CARRELLO PER FUSTI DA 20 -60 Kg TROLLEY FOR DRUMS 20 - 60 kg	1

Art. KR6850 **KIT GUARNIZIONI COMPLETO**
COMPOSTO DALLE GUARNIZIONI SOTTO ELENCAE JOINTS GASKETS LIST INCLUDING ALL THE GASKETS SHOWN HERE UNDER

CODICE CODE	DESCRIZIONE DESCRIPTION	Q.TÀ QTY
H090	O-RING 3056 O-RING 3056	1
H128	O-RING 4100 O-RING 4100	2

PER I KIT RICAMBI DELL' Art. 80035 VEDERE I RELATIVI ESPLOSI
FOR THE SPARE PARTS KITS OF Art. 80035 PLEASE REFER TO PERTINENT EXPLODED VIEWS

Art. KS6880 **SET RICAMBI CONSIGLIATI**
AI PUNTI VENDITA E ASSISTENZA, COMPOSTO DAI RICAMBI SOTTO ELENCAE
SPARE PARTS KIT ADVISED
TO THE REPAIR CENTERS. THIS KIT INCLUDES ALL THE SPARE PARTS SHOWN HERE UNDER

CODICE CODE	DESCRIZIONE DESCRIPTION	Q.TÀ QTY
KR6802	TUBO EROGAZIONE COMPLETO COMPLETE GREASE DELIVERY HOSE	1
KR6850	KIT GUARNIZIONI COMPLETO COMPLETE GASKETS KIT	1



Art. 61410 - Art. 61411



VISTA ESPLOSA - EXPLODED VIEW

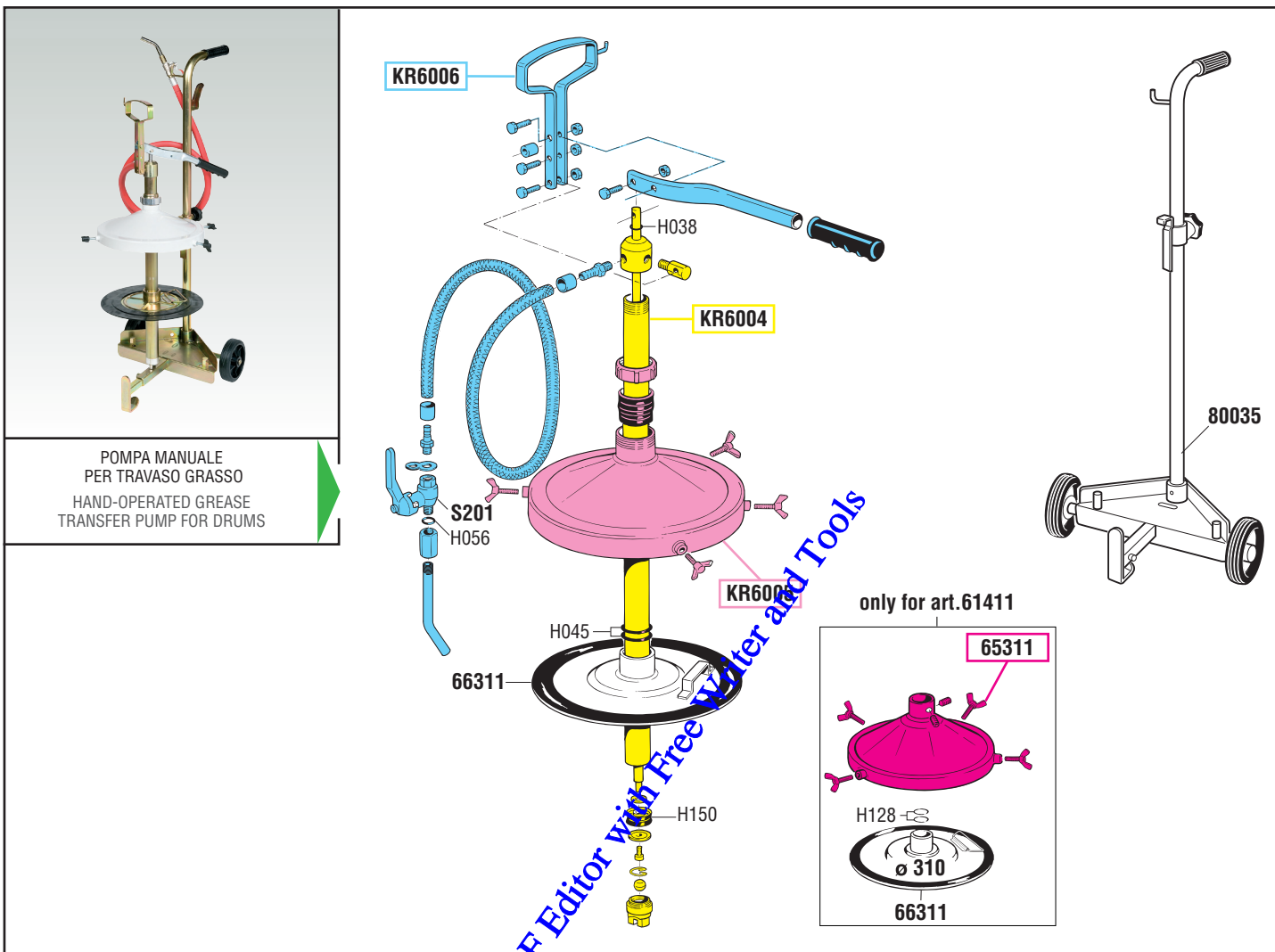

POMPA MANUALE
PER TRAVASO GRASSO
HAND-OPERATED GREASE
TRANSFER PUMP FOR DRUMS

GUIDA RICAMBI - SPARE PARTS GUIDE

KIT RICAMBI
OGNI KIT SOTTO RIPORTATO COMPRENDE I RICAMBI EVIDENZIATI CON LO STESSO COLORE E LE RELATIVE GUARNIZIONI. QUESTI RICAMBI NON SONO FORNIBILI SEPARATAMENTE TRANNE QUELLI CODIFICATI.

SPARE PARTS KITS
EACH KIT SHOWN WITH THE SAME COLOR INCLUDES ALSO THE GASKETS. THE SPARE PARTS INCLUDED IN THE KIT CAN'T BE SUPPLIED SEPARATELY EXCEPT THOSE SHOWN WITH A PROPER CODE.

CODICE CODE	DESCRIZIONE DESCRIPTION	Q.TÀ QTY
KR6004	POMPA GRASSO MANUALE MANUAL GREASE PUMP	1
KR6005	COPRIFUSTO ø 310 mm COVER ø 310 mm	1
KR6006	ACCESSORI MANICO - TUBO HANDLE ACCESSORIES - HOSE	1
65311	COPRIFUSTO ø 337 mm COVER ø 337 mm	1

ELENCO RICAMBI FORNIBILI SINGOLARMENTE
LIST OF SPARE PARTS WHICH CAN BE SUPPLIED SEPARATELY

CODICE CODE	DESCRIZIONE DESCRIPTION	Q.TÀ QTY
66311	MEMBRANA INGRASSATORE MANUALE FOLLOWER PLATE OF MANUAL PUMP	1
80035	CARRELLO PER FUSTI DA 20 -60 Kg TROLLEY FOR DRUMS 20 - 60 kg	1
S201	RUBINETTO A SFERA 1/4" BALL VALVE 1/4"	1

Art. KR6852

KIT GUARNIZIONI COMPLETO
COMPOSTO DALLE GUARNIZIONI SOTTO ELENCAE
JOINTS GASKETS LIST
INCLUDING ALL THE GASKETS SHOWN HERE UNDER

CODICE CODE	DESCRIZIONE DESCRIPTION	Q.TÀ QTY
H038	O-RING 115 O-RING 115	1
H045	O-RING 4150 O-RING 4150	2
H056	O-RING 114 O-RING 114	1
H128	O-RING 4100 O-RING 4100	2
H150	GUARNIZIONE GASKET	1

tutti i diritti riservati - all rights reserved



Art. 62041 Mod. 50:1/41 - Art. 62041/A Mod. 50:1/41 - Art. 62048 Mod. 50:1/48
Art. 62074 Mod. 50:1/73 - Art. 62095 Mod. 50:1/94



VISTA ESPLOSA - EXPLODED VIEW

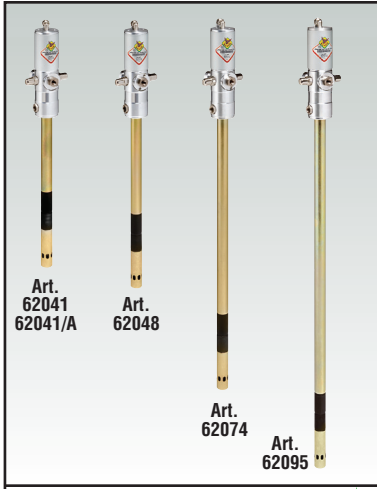

POMPE PNEUMATICHE PER DISTRIBUZIONE GRASSO A BREVE E LUNGA DISTANZE
AIR-OPERATED PUMPS FOR SHORT/LONG DISTANCE GREASE DISTRIBUTION

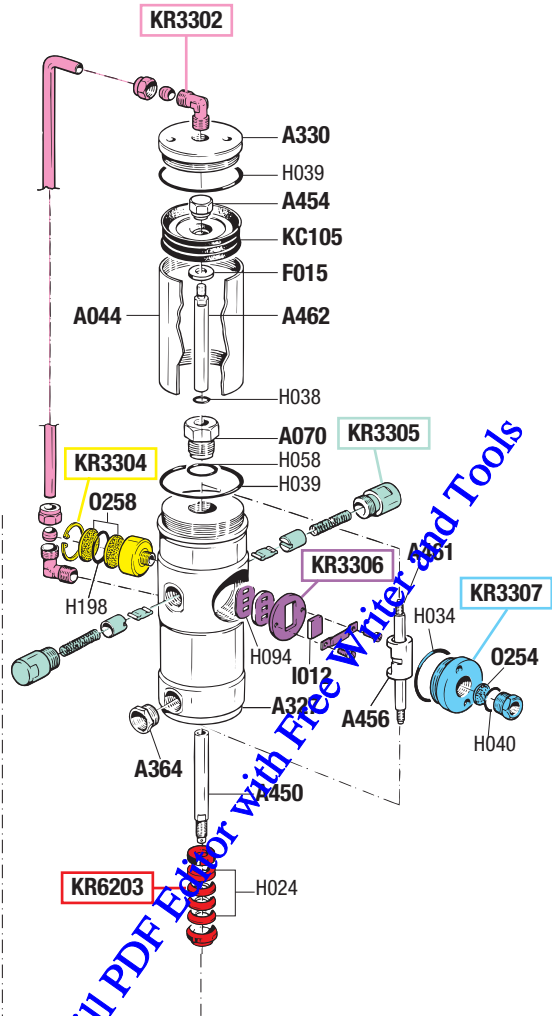

PDFFill PDF Editor with Free Writer and Tools

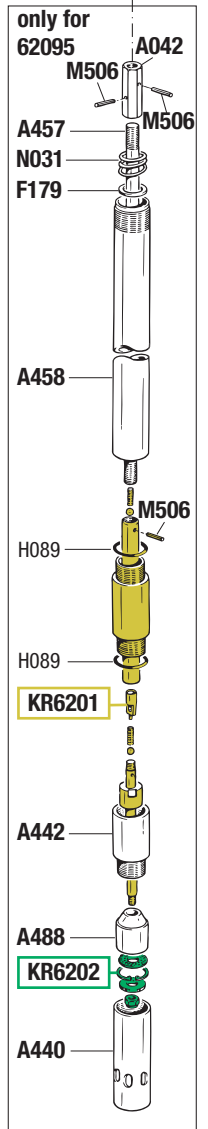
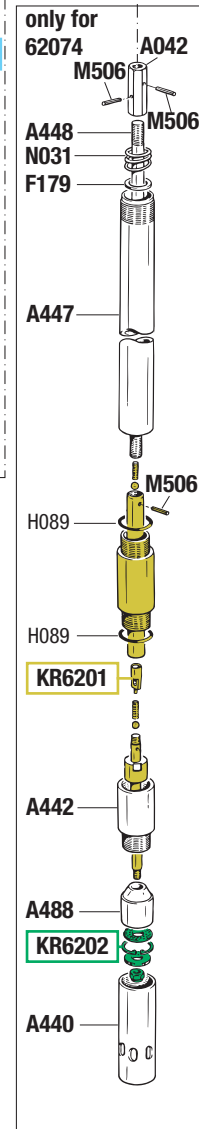
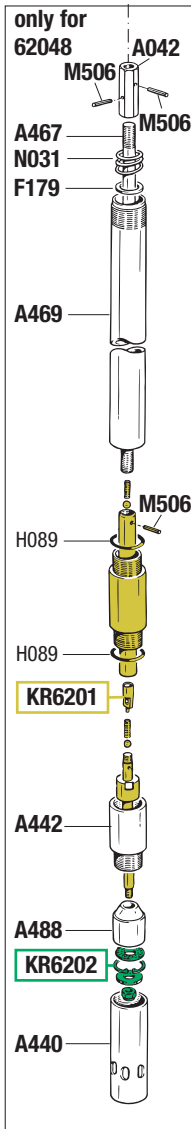
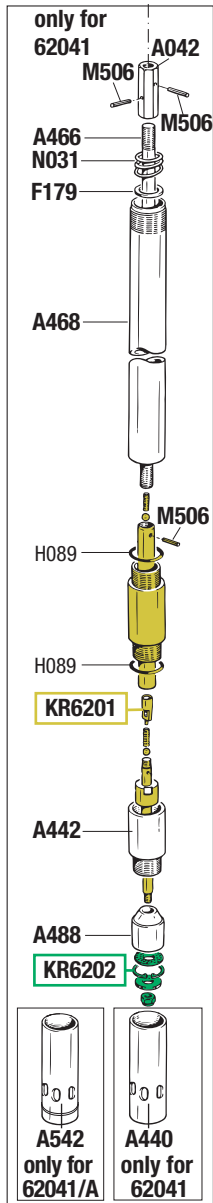

tutti i diritti riservati - all rights reserved

GUIDA RICAMBI - SPARE PARTS GUIDE

KIT RICAMBI
OGNI KIT SOTTO RIPORTATO COMPRENDE I RICAMBI EVIDENZIATI CON LO STESSO COLORE E LE RELATIVE GUARNIZIONI. QUESTI RICAMBI NON SONO FORNIBILI SEPARATAMENTE TRANNE QUELLI CODIFICATI.

SPARE PARTS KITS

EACH KIT SHOWN WITH THE SAME COLOR INCLUDES ALSO THE GASKETS. THE SPARE PARTS INCLUDED IN THE KIT CAN'T BE SUPPLIED SEPARATELY EXCEPT THOSE SHOWN WITH A PROPER CODE.

CODICE CODE	DESCRIZIONE DESCRIPTION	Q.TÀ QTY
KR3302	TUBO RICICLO CON RACCORDI TUBE WITH CONNECTIONS	1
KR3304	SILENZIATORE MUFFLER	1
KR3305	DOPPIO GRUPPO INVERTITORE DOUBLE PLUNGER GROUP	1
KR3306	GRUPPO DISTRIBUTORE D'ARIA SLIDE VALVE GROUP	1
KR3307	TAPPO ENTRATA ARIA AIR INLET CONNECTION	1
KR6201	GRUPPO POMPANTE CON VALVOLE PUMPING GROUP WITH VALVES	1
KR6202	FILTRO E RONDELLA POMPANTE FILTER AND WASHER FOR SHANK	1
KR6203	GUARNIZIONI PACCO-RONDELLA SET OF GASKETS WITH WASHER	1

ELENCO RICAMBI FORNIBILI SINGOLARMENTE LIST OF SPARE PARTS WHICH CAN BE SUPPLIED SEPARATELY

CODICE CODE	DESCRIZIONE DESCRIPTION	Q.TÀ QTY
A042	GIUNTO MOTORE POMPANTE PUMPING ELEMENT JOINT	1
A044	CILINDRO MOTORE MOTOR CYLINDER	1
A070	GUIDA STELO ROD GUIDE	1
A327	CORPO MOTORE MOTOR BODY	1
A330	TESTA MOTORE MOTOR HEAD	1
A364	ADATTATORE M 1/2" G x F 3/8" G ADAPTOR M 1/2" G x F 3/8" G	1
A440	TERMINALE PESCANTE SHANK END	1
A442	CILINDRO BATTUTA VALVOLA CYLINDER	1
A447	TUBO POMPANTE Art. 62074 PUMPING TUBE Art. 62074	1
A448	STELO POMPANTE Art. 62074 PUMPING ROD Art. 62074	1
A450	ALBERO INFERIORE MOTORE MOTOR SPINDLE	1
A454	DADO BLOCCA PISTONE PISTON LOCKING NUT	1
A456	SPINGI INVERTITORE SHUTTLE	1
A457	STELO POMPANTE Art. 62095 PUMPING ROD Art. 62095	1
A458	TUBO POMPANTE Art. 62095 PUMPING TUBE Art. 62095	1
A461	ALBERO CENTRALE MOTORE MOTOR SPINDLE	1
A462	ALBERO PISTONE MOTORE MOTOR PISTON SPINDLE	1
A466	STELO POMPANTE Art. 62041 PUMPING ROD Art. 62041	1
A467	STELO POMPANTE Art. 62048 PUMPING ROD Art. 62048	1
A468	TUBO POMPANTE Art. 62041 PUMPING TUBE Art. 62041	1
A469	TUBO POMPANTE Art. 62048 PUMPING TUBE Art. 62048	1
A488	TAMPONE COMPENSATORE PLUG STOPPER	1
A542	TERMINALE PESCANTE SHANK END	1
F015	RONDELLA WASHER	1
F179	RONDELLA FERMO MOLLA WASHER	1
M506	SPINA ELASTICA ø 3 x 14 PIN ø 3 x 14	3
M507	MOLLA PREMI PACCO SPRING	1

Art. KR6250

KIT GUARNIZIONI COMPLETO COMPOSTO DALLE GUARNIZIONI SOTTO ELENCAE JOINTS GASKETS LIST INCLUDING ALL THE GASKETS SHOWN HERE UNDER

CODICE CODE	DESCRIZIONE DESCRIPTION	Q.TÀ QTY
H024	GUARNIZIONI PACCO GASKET	4
H034	O-RING 3156 O-RING 3156	1
H038	O-RING 115 O-RING 115	1
H039	O-RING 3225 O-RING 3225	2
H040	O-RING 123 O-RING 123	1
H058	O-RING 2068 O-RING 2068	1
H089	O-RING 3081 O-RING 3081	2
H094	GUARNIZIONI BASE DISTRIBUTORE GASKET	1
H198	O-RING 3106 O-RING 3106	1
I012	DISTRIBUTORE ARIA SLIDE VALVE	1
KC105	PISTONE PISTON	1
O254	SILENZIATORE A PASTICCA MUFFLER	1
O258	SILENZIATORE A PASTICCA MUFFLER	2

Art. KS6280

SET RICAMBI CONSIGLIATI AI PUNTI VENDITA E ASSISTENZA. COMPOSTO DAI RICAMBI SOTTO ELENCAE SPARE PARTS KIT ADVISED TO THE REPAIR CENTERS. THIS KIT INCLUDES ALL THE SPARE PARTS SHOWN HERE UNDER

CODICE CODE	DESCRIZIONE DESCRIPTION	Q.TÀ QTY
A450	ALBERO INFERIORE MOTORE MOTOR SPINDLE	1
KR3305	DOPPIO GRUPPO INVERTITORE DOUBLE PLUNGER GROUP	1
KR3306	GRUPPO DISTRIBUTORE D'ARIA SLIDE VALVE GROUP	1
KR6250	KIT GUARNIZIONI COMPLETO COMPLETE GASKETS KIT	1
M506	SPINA ELASTICA ø 3 x 14 PIN ø 3 x 14	3

RAASM

FLUIDS AND LUBRICATION EQUIPMENT



Art. 63041 Mod. 65:1/41 - Art. 63048 Mod. 65:1/48
Art. 63074 Mod. 65:1/73 - Art. 63095 Mod. 65:1/94



VISTA ESPLOSA - EXPLODED VIEW

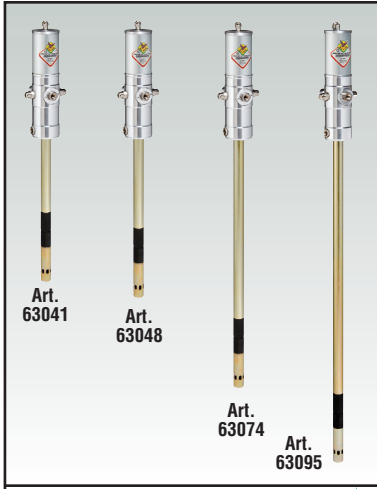

POMPE PNEUMATICHE PER DISTRIBUZIONE GRASSO A BREVE E LUNGA DISTANZA
AIR-OPERATED PUMPS FOR SHORT/LONG DISTANCE GREASE DISTRIBUTION

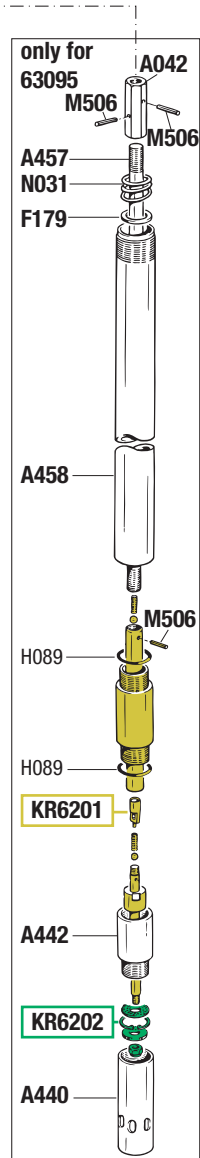
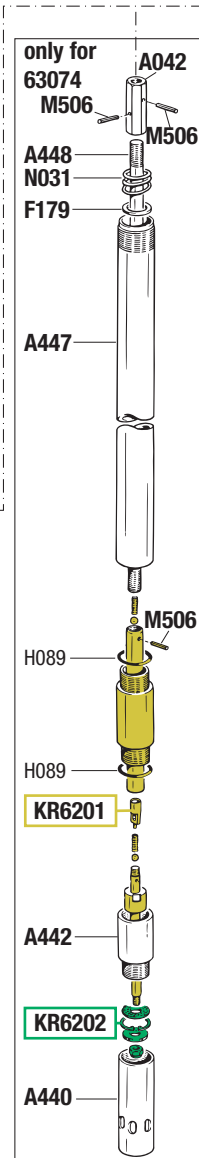
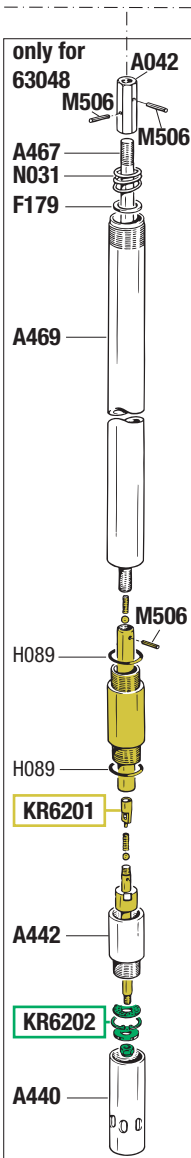
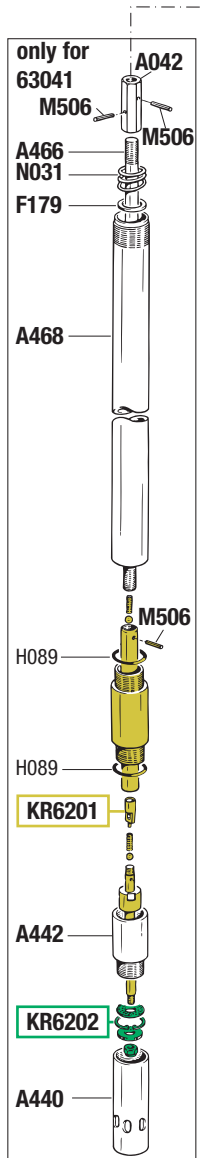
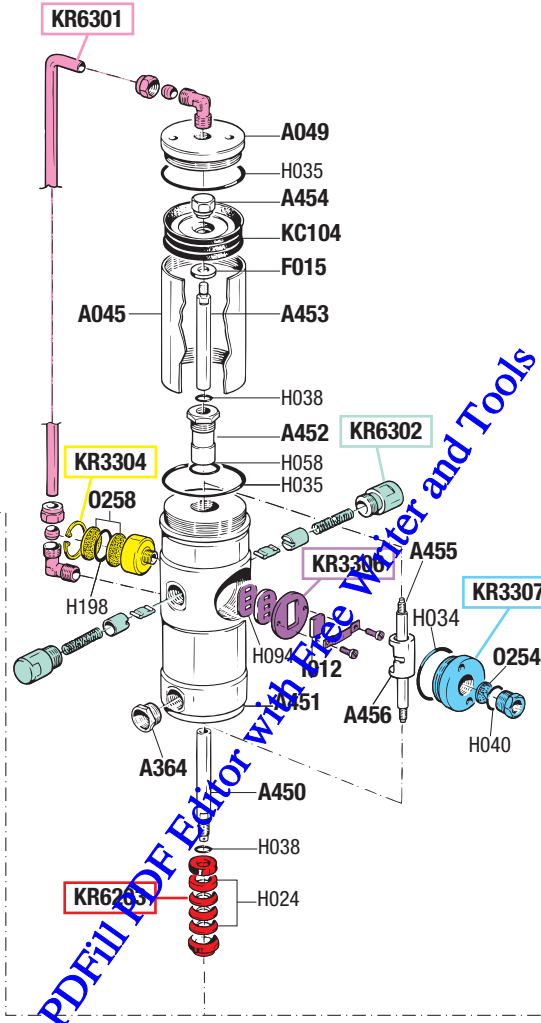

PDFFill PDF Editor with Free Writer and Tools

tutti i diritti riservati - all rights reserved



GUIDA RICAMBI - SPARE PARTS GUIDE

KIT RICAMBI		
OGNI KIT SOTTO RIPORTATO COMPRENDE I RICAMBI EVIDENZIATI CON LO STESSO COLORE E LE RELATIVE GUARNIZIONI. QUESTI RICAMBI NON SONO FORNIBILI SEPARATAMENTE TRANNE QUELLI CODIFICATI.		
SPARE PARTS KITS		
EACH KIT SHOWN WITH THE SAME COLOR INCLUDES ALSO THE GASKETS. THE SPARE PARTS INCLUDED IN THE KIT CAN'T BE SUPPLIED SEPARATELY EXCEPT THOSE SHOWN WITH A PROPER CODE.		
CODICE CODE	DESCRIZIONE DESCRIPTION	Q.TÀ QTY
KR3304	SILENZIATORE MUFFLER	1
KR3306	GRUPPO DISTRIBUTORE D'ARIA SLIDE VALVE GROUP	1
KR3307	TAPPO ENTRATA ARIA AIR INLET CONNECTION	1
KR6201	GRUPPO POMPANTE CON VALVOLE PUMPING GROUP WITH VALVES	1
KR6202	FILTRO E RONDELLA POMPANTE FILTER AND WASHER FOR SHANK	1
KR6203	GUARNIZIONI PACCO-RONDELLA SET OF GASKETS WITH WASHER	1
KR6301	TUBO RICICLO CON RACCORDI TUBE WITH CONNECTIONS	1
KR6302	DOPPIO GRUPPO INVERTITORE DOUBLE PLUNGER GROUP	1

ELENCO RICAMBI FORNIBILI SINGOLARMENTE		
LIST OF SPARE PARTS WHICH CAN BE SUPPLIED SEPARATELY		
CODICE CODE	DESCRIZIONE DESCRIPTION	Q.TÀ QTY
A042	GIUNTO MOTORE POMPANTE PUMPING ELEMENT JOINT	1
A045	CILINDRO MOTORE MOTOR CYLINDER	1
A049	TESTA MOTORE MOTOR HEAD	1
A364	ADATTATORE M 1/2" G x F 3/8" G ADAPTOR M 1/2" G x F 3/8" G	1
A440	TERMINALE PESCANTE SHANK END	1
A442	CILINDRO BATTUTA VALVOLA CYLINDER	1
A447	TUBO POMPANTE Art. 63074 PUMPING TUBE Art. 63074	1
A448	STELO POMPANTE Art. 63074 PUMPING ROD Art. 63074	1
A450	ALBERO INFERIORE MOTORE MOTOR SPINDLE	1
A451	CORPO MOTORE MOTOR BODY	1
A452	GUIDA STELO ROD GUIDE	1
A453	ALBERO PISTONE MOTORE MOTOR PISTON	1
A454	DADO BLOCCA PISTONE PISTON LOCKING NUT	1
A455	ALBERO CENTRALE MOTORE MOTOR SPINDLE	1
A456	SPINGI INVERTITORE SHUTTLE	1
A457	STELO POMPANTE Art. 63095 PUMPING ROD Art. 63095	1
A458	TUBO POMPANTE Art. 63095 PUMPING TUBE Art. 63095	1
A466	STELO POMPANTE Art. 63041 PUMPING ROD Art. 63041	1
A467	STELO POMPANTE Art. 63048 PUMPING ROD Art. 63048	1
A468	TUBO POMPANTE Art. 63041 PUMPING TUBE Art. 63041	1
A469	TUBO POMPANTE Art. 63048 PUMPING TUBE Art. 63048	1
F015	RONDELLA WASHER	1
F179	RONDELLA FERMO MOLLA WASHER	1
M506	SPINA ELASTICA ø 3 x 14 PIN ø 3 x 14	3
N031	MOLLA PREMI PACCO SPRING	1

Art. KR6350		
KIT GUARNIZIONI COMPLETO		
COMPOSTO DALLE GUARNIZIONI SOTTO ELENCAE		
JOINTS GASKETS LIST		
INCLUDING ALL THE GASKETS SHOWN HERE UNDER		
CODICE CODE	DESCRIZIONE DESCRIPTION	Q.TÀ QTY
H024	GUARNIZIONI PACCO GASKET	4
H034	O-RING 3156 O-RING 3156	1
H035	O-RING 3268 O-RING 3268	2
H038	O-RING 115 O-RING 115	2
H040	O-RING 123 O-RING 123	1
H058	O-RING 2068 O-RING 2068	1
H089	O-RING 3081 O-RING 3081	2
H094	GUARNIZIONI BASE DISTRIBUTORE GASKET	1
H198	O-RING 3106 O-RING 3106	1
I012	DISTRIBUTORE ARIA SLIDE VALVE	1
KC104	PISTONE MOTORE MOTOR PISTON	1
O254	SILENZIATORE A PASTICCA MUFFLER	1
O258	SILENZIATORE A PASTICCA MUFFLER	2

Art. KS6380		
SET RICAMBI CONSIGLIATI		
AI PUNTI VENDITA E ASSISTENZA,		
COMPOSTO DAI RICAMBI SOTTO ELENCAE		
SPARE PARTS KIT ADVISED		
TO THE REPAIR CENTERS. THIS KIT INCLUDES		
ALL THE SPARE PARTS SHOWN HERE UNDER		
CODICE CODE	DESCRIZIONE DESCRIPTION	Q.TÀ QTY
A450	ALBERO INFERIORE MOTORE MOTOR SPINDLE	1
KR3306	GRUPPO DISTRIBUTORE D'ARIA SLIDE VALVE GROUP	1
KR6302	DOPPIO GRUPPO INVERTITORE DOUBLE PLUNGER GROUP	1
KR6350	KIT GUARNIZIONI COMPLETO COMPLETE GASKETS KIT	1
M506	SPINA ELASTICA ø 3 x 14 PIN ø 3 x 14	3



Art. 65138 - Art. 65142 - Art. 65160 - Art. 65280 - Art. 65310
 Art. 65350 - Art. 65385 - Art. 65420 - Art. 65600 - Art. 10/50
 Art. 10/51 - Art. 10/52 - Art. 10/55 - Art. 10/56 - Art. 10/57



VISTA ESPLOSA - EXPLODED VIEW



COPRIFUSTO
DRUM COVER

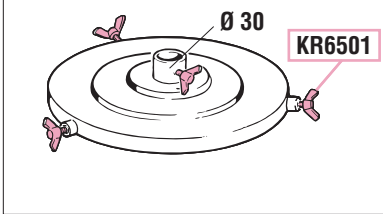

only for
65280 - 65310 - 65350
65385 - 65420 - 65600

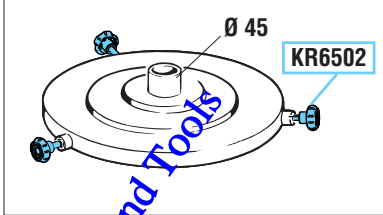

only for
10/50 - 10/51 - 10/52

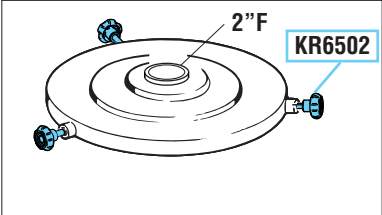

only for
65138 - 65142 - 65160

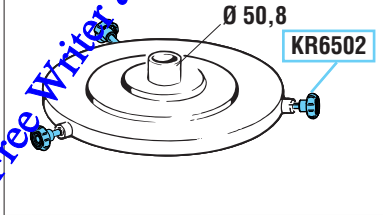

only for
10/55 - 10/56 - 10/57

tutti i diritti riservati - all rights reserved

GUIDA RICAMBI - SPARE PARTS GUIDE

KIT RICAMBI
 OGNI KIT SOTTO RIPORTATO COMPRENDE I RICAMBI EVIDENZIATI CON LO STESSO COLORE E LE RELATIVE GUARNIZIONI. QUESTI RICAMBI NON SONO FORNIBILI SEPARATAMENTE TRANNE QUELLI CODIFICATI.

SPARE PARTS KITS
 EACH KIT SHOWN WITH THE SAME COLOR INCLUDES ALSO THE GASKETS. THE SPARE PARTS INCLUDED IN THE KIT CAN'T BE SUPPLIED SEPARATELY EXCEPT THOSE SHOWN WITH A PROPER CODE.

CODICE CODE	DESCRIZIONE DESCRIPTION	Q.TÀ QTY
KR6501	VITERIA BOLTS AND SCREWS	1
KR6502	VITERIA BOLTS AND SCREWS	1

PDF Editor with Free Writer and Tools



Art. 65309 - Art. 65311



VISTA ESPLOSA - EXPLODED VIEW

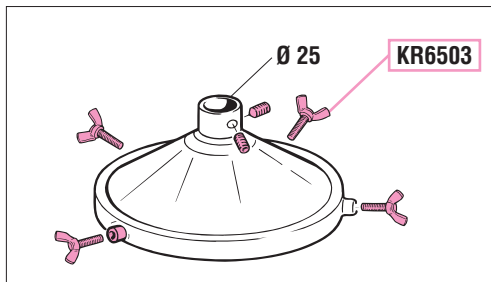

only for 65309

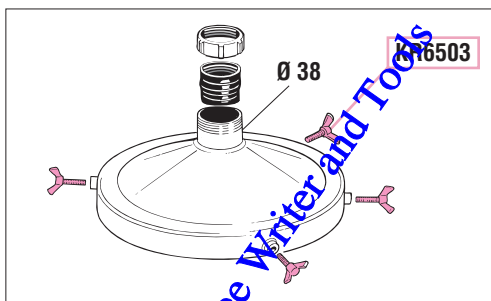

only for 65311

GUIDA RICAMBI - SPARE PARTS GUIDE

KIT RICAMBI

OGNI KIT SOTTO RIPORTATO COMPRENDE I RICAMBI EVIDENZIATI CON LO STESSO COLORE E LE RELATIVE GUARNIZIONI. QUESTI RICAMBI NON SONO FORNIBILI SEPARATAMENTE TRANNE QUELLI CODIFICATI.

SPARE PARTS KITS

EACH KIT SHOWN WITH THE SAME COLOR INCLUDES ALSO THE GASKETS. THE SPARE PARTS INCLUDED IN THE KIT CAN'T BE SUPPLIED SEPARATELY EXCEPT THOSE SHOWN WITH A PROPER CODE.

CODICE CODE	DESCRIZIONE DESCRIPTION	Q.TÀ QTY
KR6503	VITERIA BOLTS AND SCREWS	1

PDFEditor with Free Writer and Tools

tutti i diritti riservati - all rights reserved



Art. 66855



VISTA ESPLOSA - EXPLODED VIEW



IMPUGNATURA
PISTOLA GRASSO
GREASE GUN
VALVE

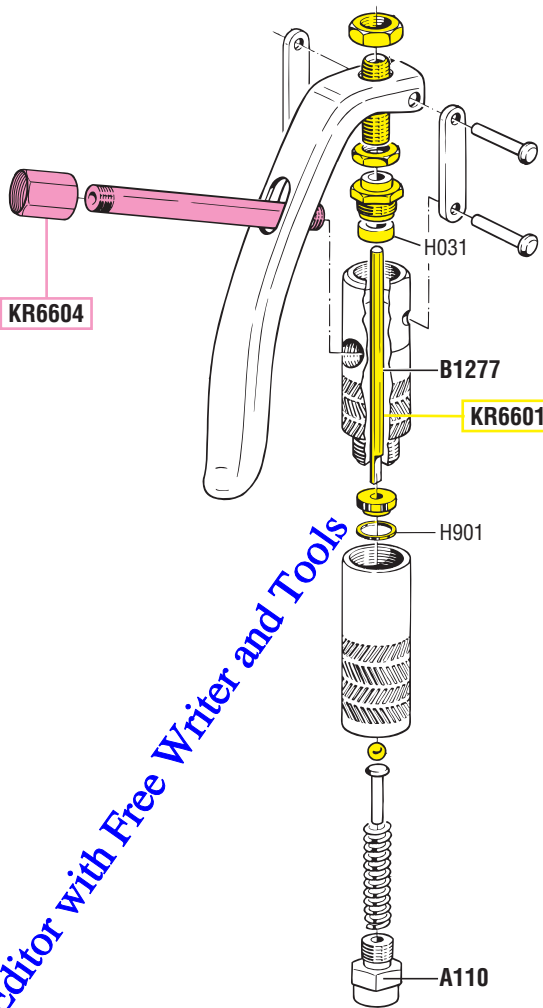

GUIDA RICAMBI - SPARE PARTS GUIDE

KIT RICAMBI

OGNI KIT SOTTO RIPORTATO COMPRENDE I RICAMBI EVIDENZIATI CON LO STESSO COLORE E LE RELATIVE GUARNIZIONI. QUESTI RICAMBI NON SONO FORNIBILI SEPARATAMENTE TRANNE QUELLI CODIFICATI.

SPARE PARTS KITS

EACH KIT SHOWN WITH THE SAME COLOR INCLUDES ALSO THE GASKETS. THE SPARE PARTS INCLUDED IN THE KIT CAN'T BE SUPPLIED SEPARATELY EXCEPT THOSE SHOWN WITH A PROPER CODE.

CODICE CODE	DESCRIZIONE DESCRIPTION	Q.TÀ QTY
KR6601	STELO E GRANO REGOLA LEVA ROD GROUP AND HANDLE CONTROL NUT	1
KR6604	TUBO DI CONNESSIONE CONNECTION PIPE	1

ELENCO RICAMBI FORNIBILI SINGOLARMENTE

LIST OF SPARE PARTS WHICH CAN BE SUPPLIED SEPARATELY

CODICE CODE	DESCRIZIONE DESCRIPTION	Q.TÀ QTY
A110	MANICOTTO COUPLING	1
B1277	STELO ROD	1

Art.
KR6650

KIT GUARNIZIONI COMPLETO

COMPOSTO DALLE GUARNIZIONI SOTTO ELENCAE
JOINTS GASKETS LIST
INCLUDING ALL THE GASKETS SHOWN HERE UNDER

CODICE CODE	DESCRIZIONE DESCRIPTION	Q.TÀ QTY
H031	GUARNIZIONE GASKET	1
H901	GUARNIZIONE GASKET	1

Art.
KS6686

SET RICAMBI CONSIGLIATI

AI PUNTI VENDITA E ASSISTENZA,
COMPOSTO DAI RICAMBI SOTTO ELENCAE
SPARE PARTS KIT ADVISED
TO THE REPAIR CENTERS. THIS KIT INCLUDES
ALL THE SPARE PARTS SHOWN HERE UNDER

CODICE CODE	DESCRIZIONE DESCRIPTION	Q.TÀ QTY
B1277	STELO ROD	1
KR6650	KIT GUARNIZIONI COMPLETO COMPLETE GASKETS KIT	1

tutti i diritti riservati - all rights reserved





Art. 66860 - Art. 66888 - Art. 66889



VISTA ESPLOSA - EXPLODED VIEW

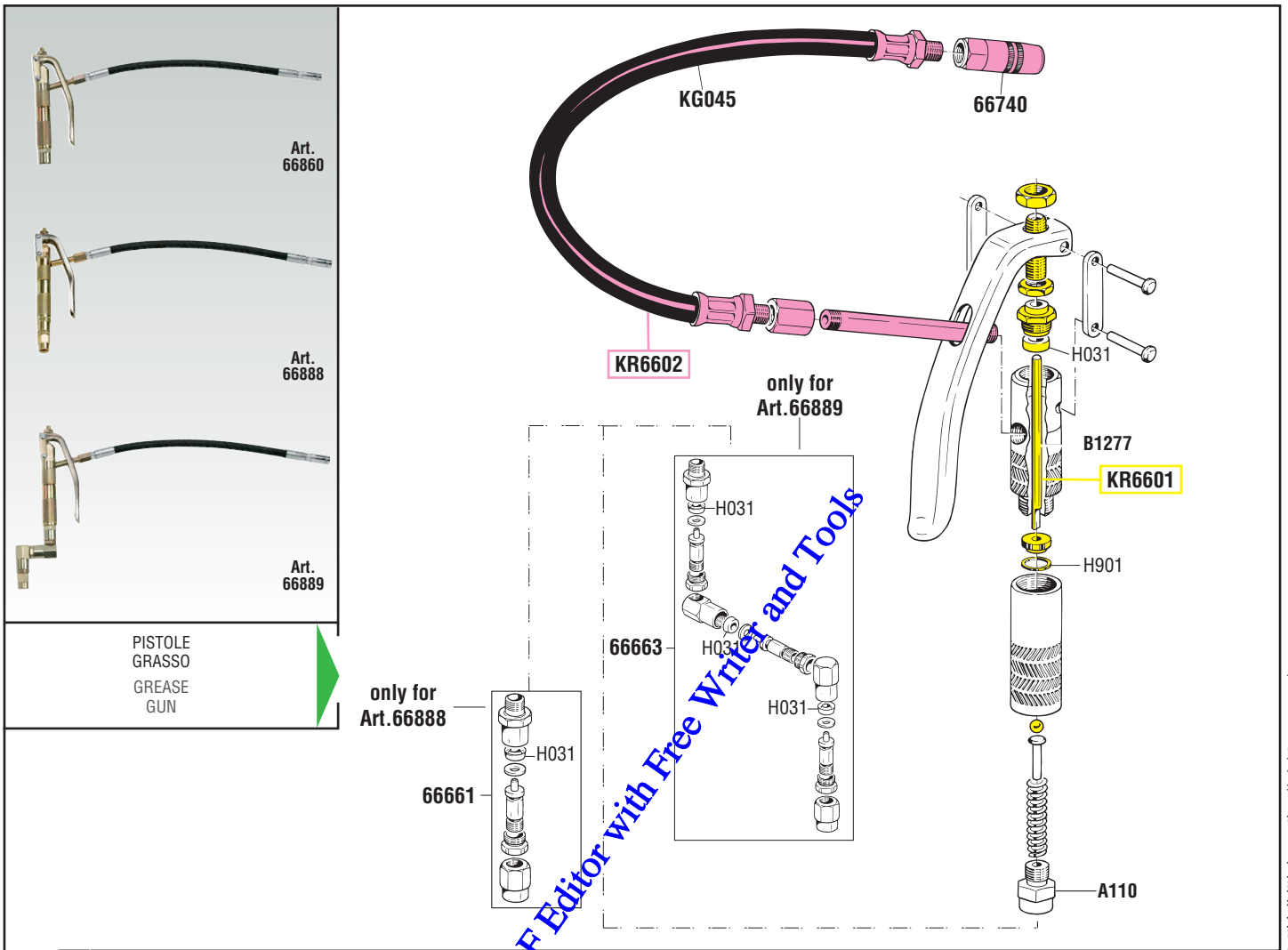

tutti i diritti riservati - all rights reserved

GUIDA RICAMBI - SPARE PARTS GUIDE

KIT RICAMBI
OGNI KIT SOTTO RIPORTATO COMPRENDE I RICAMBI EVIDENZIATI CON LO STESSO COLORE E LE RELATIVE GUARNIZIONI. QUESTI RICAMBI NON SONO FORNIBILI SEPARATAMENTE TRANNE QUELLI CODIFICATI.

SPARE PARTS KITS
EACH KIT SHOWN WITH THE SAME COLOR INCLUDES ALSO THE GASKETS. THE SPARE PARTS INCLUDED IN THE KIT CAN'T BE SUPPLIED SEPARATELY EXCEPT THOSE SHOWN WITH A PROPER CODE.

CODICE CODE	DESCRIZIONE DESCRIPTION	Q.TÀ QTY
KR6601	STELO E GRANO REGOLA LEVA ROD GROUP AND HANDLE CONTROL NUT	1
KR6602	TUBO DI CONNESSIONE CONNECTION PIPE	1

ELENCO RICAMBI FORNIBILI SINGOLARMENTE
LIST OF SPARE PARTS WHICH CAN BE SUPPLIED SEPARATELY

CODICE CODE	DESCRIZIONE DESCRIPTION	Q.TÀ QTY
66661	SNODO DRITTO STRAIGHT SWIVEL JOINT	1
66663	SNODO TRIPLO TRIPLE SWIVEL JOINT	1
66740	TESTINA DI GRASSAGGIO 4 JAWS GREASE FITTING	1
A110	MANICOTTO COUPLING	1
B1277	STELO ROD	1
KG045	TUBO EROGAZIONE DELIVERY HOSE	1

Art. KR6652 **KIT GUARNIZIONI COMPLETO**
COMPOSTO DALLE GUARNIZIONI SOTTO ELENCATE
JOINTS GASKETS LIST
INCLUDING ALL THE GASKETS SHOWN HERE UNDER

CODICE CODE	DESCRIZIONE DESCRIPTION	Q.TÀ QTY
H031	GUARNIZIONE GASKET	4
H901	GUARNIZIONE GASKET	1

Art. KS6683 **SET RICAMBI CONSIGLIATI**
AI PUNTI VENDITA E ASSISTENZA.
COMPOSTO DAI RICAMBI SOTTO ELENCA TI
SPARE PARTS KIT ADVISED
TO THE REPAIR CENTERS. THIS KIT INCLUDES
ALL THE SPARE PARTS SHOWN HERE UNDER

CODICE CODE	DESCRIZIONE DESCRIPTION	Q.TÀ QTY
66740	TESTINA DI GRASSAGGIO 4 JAWS GREASE FITTING	1
B1277	STELO ROD	1
KG045	TUBO EROGAZIONE DELIVERY HOSE	1
KR6652	KIT GUARNIZIONI COMPLETO COMPLETE GASKETS KIT	1



Art. 66880 - Art. 66881 - Art. 66882



VISTA ESPLOSA - EXPLODED VIEW

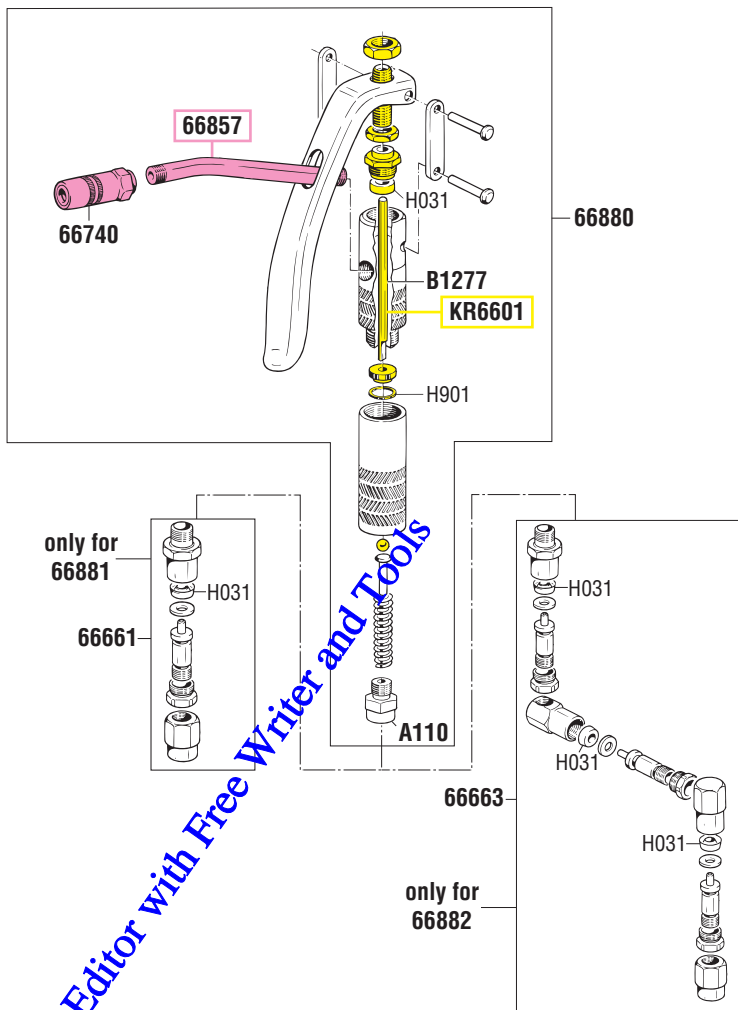

GUIDA RICAMBI - SPARE PARTS GUIDE

KIT RICAMBI
OGNI KIT SOTTO RIPORTATO COMPRENDE I RICAMBI EVIDENZIATI CON LO STESSO COLORE E LE RELATIVE GUARNIZIONI. QUESTI RICAMBI NON SONO FORNIBILI SEPARATAMENTE TRANNE QUELLI CODIFICATI.

SPARE PARTS KITS
EACH KIT SHOWN WITH THE SAME COLOR INCLUDES ALSO THE GASKETS. THE SPARE PARTS INCLUDED IN THE KIT CAN'T BE SUPPLIED SEPARATELY EXCEPT THOSE SHOWN WITH A PROPER CODE.

CODICE CODE	DESCRIZIONE DESCRIPTION	Q.TÀ QTY
KR6601	STELO E GRANO REGOLA LEVA ROD GROUP AND HANDLE CONTROL NUT	1
66857	TERMINALE RIGIDO RIGID TERMINAL	1

ELENCO RICAMBI FORNIBILI SINGOLARMENTE
LIST OF SPARE PARTS WHICH CAN BE SUPPLIED SEPARATELY

CODICE CODE	DESCRIZIONE DESCRIPTION	Q.TÀ QTY
66661	SNODO DRITTO STRAIGHT SWIVEL JOINT	1
66663	SNODO TRIPLO TRIPLE SWIVEL JOINT	1
66740	TESTINA DI GRASSAGGIO 4 JAWS GREASE FITTING	1
A110	MANICOTTO COUPLING	1
B1277	STELO ROD	1

Art. KR6652 **KIT GUARNIZIONI COMPLETO**
COMPOSTO DALLE GUARNIZIONI SOTTO ELENCATE
JOINTS GASKETS LIST
INCLUDING ALL THE GASKETS SHOWN HERE UNDER

CODICE CODE	DESCRIZIONE DESCRIPTION	Q.TÀ QTY
H031	GUARNIZIONE GASKET	5
H901	GUARNIZIONE GASKET	1

Art. KS6685 **SET RICAMBI CONSIGLIATI**
AI PUNTI VENDITA E ASSISTENZA,
COMPOSTO DAI RICAMBI SOTTO ELENCATI
SPARE PARTS KIT ADVISED
TO THE REPAIR CENTERS. THIS KIT INCLUDES
ALL THE SPARE PARTS SHOWN HERE UNDER

CODICE CODE	DESCRIZIONE DESCRIPTION	Q.TÀ QTY
66740	TESTINA DI GRASSAGGIO 4 JAWS GREASE FITTING	1
B1277	STELO ROD	1
KR6652	KIT GUARNIZIONI COMPLETO COMPLETE GASKETS KIT	1

tutti i diritti riservati - all rights reserved



Art. 68012 Mod. IM.13 KG



VISTA ESPLOSA - EXPLODED VIEW



INGRASSATORE MANUALE, PORTATILE, AD ALTA PRESSIONE 350 - 400 bar
PORTABLE HIGH-PRESSURE 350 - 400 bar
HAND-OPERATED GREASE PUMP

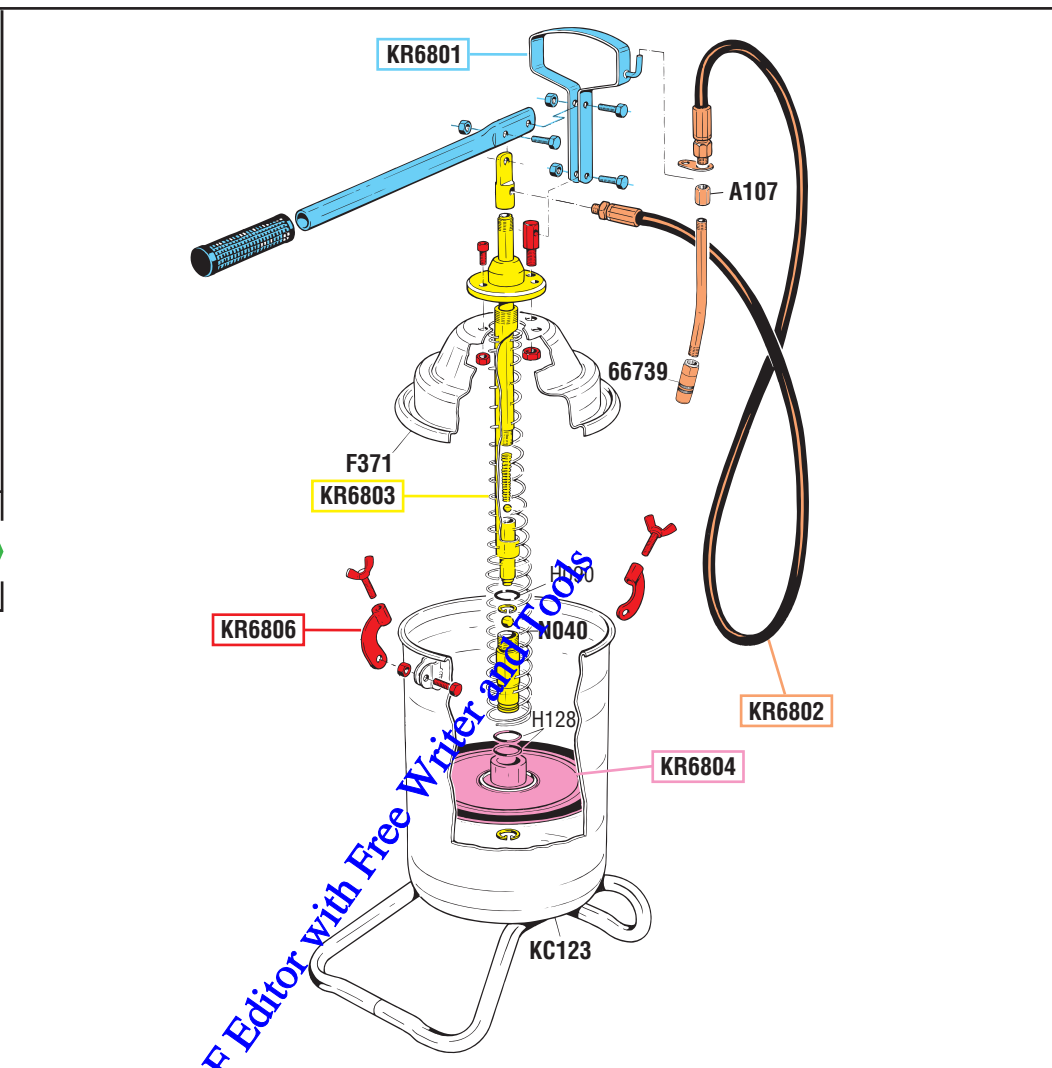

GUIDA RICAMBI - SPARE PARTS GUIDE

KIT RICAMBI
OGNI KIT SOTTO RIPORTATO COMPRENDE I RICAMBI EVIDENZIATI CON LO STESSO COLORE E LE RELATIVE GUARNIZIONI. QUESTI RICAMBI NON SONO FORNIBILI SEPARATAMENTE TRANNE QUELLI CODIFICATI.

SPARE PARTS KITS
EACH KIT SHOWN WITH THE SAME COLOR INCLUDES ALSO THE GASKETS. THE SPARE PARTS INCLUDED IN THE KIT CAN'T BE SUPPLIED SEPARATELY EXCEPT THOSE SHOWN WITH A PROPER CODE.

CODICE CODE	DESCRIZIONE DESCRIPTION	Q.TÀ QTY
KR6801	ACCESSORI MANICO E LEVA HANDLE ACCESSORIES AND LEVER	1
KR6802	TUBO EROGAZIONE COMPLETO COMPLETE GREASE DELIVERY HOSE	1
KR6803	POMPA GRASSO MANUALE MANUAL GREASE PUMP	1
KR6804	MEMBRANA INGRASSATORE MANUALE FOLLOWER PLATE OF MANUAL PUMP	1
KR6806	SET VITI PER SERBATOIO SET OF SCREWS FOR RESERVOIR	1

ELENCO RICAMBI FORNIBILI SINGOLARMENTE
LIST OF SPARE PARTS WHICH CAN BE SUPPLIED SEPARATELY

CODICE CODE	DESCRIZIONE DESCRIPTION	Q.TÀ QTY
66739	TESTINA DI INGRASSAGGIO 4 JAWS GREASE FITTING	1
A107	MANICOTTO GIUNZIONE COUPLING	1
F371	COPRIFUSTO DRUM COVER	1
N040	MOLLA PER MEMBRANA FOLLOWER PLATE SPRING	1
KC123	SERBATOIO RESERVOIR	1

Art. KR6850
KIT GUARNIZIONI COMPLETO
COMPOSTO DALLE GUARNIZIONI SOTTO ELENCAE
JOINTS GASKETS LIST
INCLUDING ALL THE GASKETS SHOWN HERE UNDER

CODICE CODE	DESCRIZIONE DESCRIPTION	Q.TÀ QTY
H090	O-RING 3056 O-RING 3056	1
H128	O-RING 4100 O-RING 4100	2

Art. KS6880
SET RICAMBI CONSIGLIATI
AI PUNTI VENDITA E ASSISTENZA,
COMPOSTO DAI RICAMBI SOTTO ELENCAE
SPARE PARTS KIT ADVISED
TO THE REPAIR CENTERS. THIS KIT INCLUDES
ALL THE SPARE PARTS SHOWN HERE UNDER

CODICE CODE	DESCRIZIONE DESCRIPTION	Q.TÀ QTY
KR6802	TUBO EROGAZIONE COMPLETO COMPLETE GREASE DELIVERY HOSE	1
KR6850	KIT GUARNIZIONI COMPLETO COMPLETE GASKETS KIT	1

tutti i diritti riservati - all rights reserved



Art. 68113 Mod. IMP.13 KG



VISTA ESPLOSA - EXPLODED VIEW



INGRASSATORE A PEDALE, CARRELLATO, AD ALTA PRESSIONE
WHEEL-MOUNTED HIGH-PRESSURE PEDAL-OPERATED GREASE PUMP

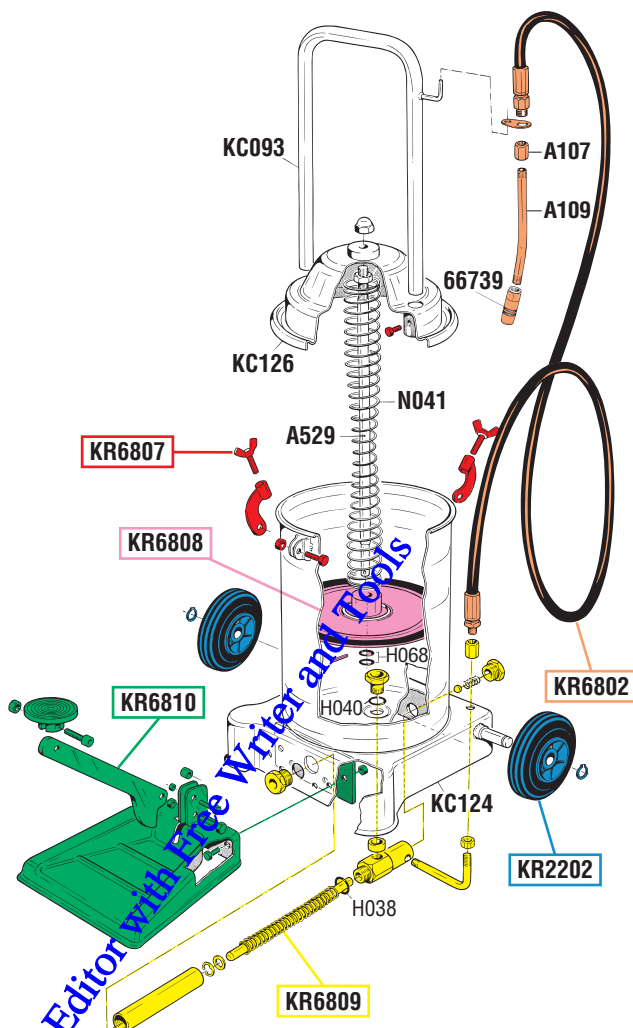

GUIDA RICAMBI - SPARE PARTS GUIDE

KIT RICAMBI
OGNI KIT SOTTO RIPORTATO COMPRENDE I RICAMBI EVIDENZIATI CON LO STESSO COLORE E LE RELATIVE GUARNIZIONI. QUESTI RICAMBI NON SONO FORNIBILI SEPARATAMENTE TRANNE QUELLI CODIFICATI.

SPARE PARTS KITS
EACH KIT SHOWN WITH THE SAME COLOR INCLUDES ALSO THE GASKETS. THE SPARE PARTS INCLUDED IN THE KIT CAN'T BE SUPPLIED SEPARATELY EXCEPT THOSE SHOWN WITH A PROPER CODE.

CODICE CODE	DESCRIZIONE DESCRIPTION	Q.TÀ QTY
KR2202	DUE RUOTE FISSE CON ANELLI ELASTICI TWO FIXED WHEELS WITH RETAINING RINGS	1
KR6802	TUBO EROGAZIONE COMPLETO COMPLETE GREASE DELIVERY HOSE	1
KR6807	SET VITI PER SERBATOIO SET OF SCREWS FOR RESERVOIR	1
KR6808	MEMBRANA INGRASSATORE PNEUMATICO FOLLOWER PLATE OF AIR OPERATED PUMP	1
KR6809	POMPA GRASSO MANUALE MANUAL GREASE PUMP	1
KR6810	PEDALE INGRASSAGGIO GREASING PEDAL	1

ELENCO RICAMBI FORNIBILI SINGOLARMENTE
LIST OF SPARE PARTS WHICH CAN BE SUPPLIED SEPARATELY

CODICE CODE	DESCRIZIONE DESCRIPTION	Q.TÀ QTY
66739	TESTINA DI INGRASSAGGIO 4 JAWS GREASE FITTING	1
A107	MANICOTTO GIUNZIONE COUPLING	1
A109	TERMINALE RIGIDO RIGID TERMINAL	1
A529	PERNO GUIDA MEMBRANA MEMBRANE GUIDE PIN	1
KC093	MANICO HANDLE	1
KC124	SERBATOIO RESERVOIR	1
KC126	COPERCHIO COVER	1
N041	MOLLA PER MEMBRANA FOLLOWER PLATE SPRING	1

Art. KR6851 **KIT GUARNIZIONI COMPLETO**
COMPOSTO DALLE GUARNIZIONI SOTTO ELENCATE
JOINTS GASKETS LIST
INCLUDING ALL THE GASKETS SHOWN HERE UNDER

CODICE CODE	DESCRIZIONE DESCRIPTION	Q.TÀ QTY
H038	O-RING 115 O-RING 115	1
H040	O-RING 123 O-RING 123	1
H068	O-RING 112 O-RING 112	2

Art. KS6882 **SET RICAMBI CONSIGLIATI**
AI PUNTI VENDITA E ASSISTENZA,
COMPOSTO DAI RICAMBI SOTTO ELENCA TI
SPARE PARTS KIT ADVISED
TO THE REPAIR CENTERS. THIS KIT INCLUDES
ALL THE SPARE PARTS SHOWN HERE UNDER

CODICE CODE	DESCRIZIONE DESCRIPTION	Q.TÀ QTY
KR6802	TUBO EROGAZIONE COMPLETO COMPLETE GREASE DELIVERY HOSE	1
KR6851	KIT GUARNIZIONI COMPLETO COMPLETE GASKETS KIT	1

tutti i diritti riservati - all rights reserved



Art. 68213 Mod. 50:1/41



VISTA ESPLOSA - EXPLODED VIEW



INGRASSATORE CARRELLATO CON POMPA PNEUMATICA R 50:1
AIR-OPERATED GREASE PUMP R 50:1
WHEEL-MOUNTED

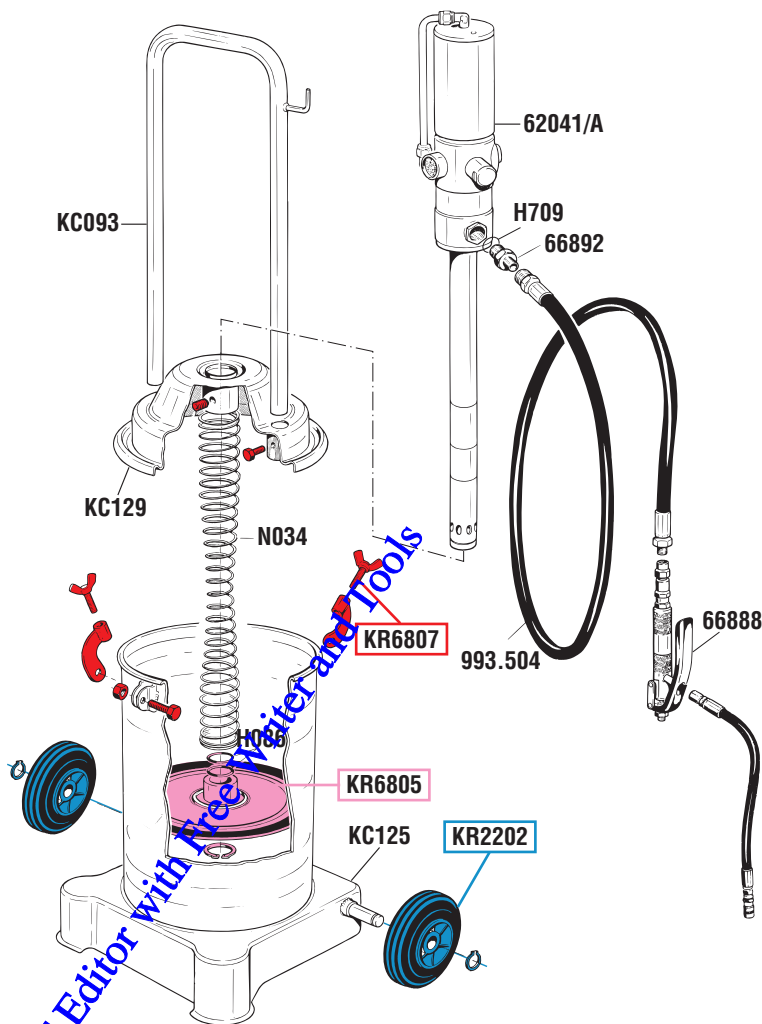

GUIDA RICAMBI - SPARE PARTS GUIDE

KIT RICAMBI

OGNI KIT SOTTO RIPORTATO COMPRENDE I RICAMBI EVIDENZIATI CON LO STESSO COLORE E LE RELATIVE GUARNIZIONI. QUESTI RICAMBI NON SONO FORNIBILI SEPARATAMENTE TRANNE QUELLI CODIFICATI.

SPARE PARTS KITS

EACH KIT SHOWN WITH THE SAME COLOR INCLUDES ALSO THE GASKETS. THE SPARE PARTS INCLUDED IN THE KIT CAN'T BE SUPPLIED SEPARATELY EXCEPT THOSE SHOWN WITH A PROPER CODE.

CODICE CODE	DESCRIZIONE DESCRIPTION	Q.TÀ QTY
KR2202	DUE RUOTE FISSE CON ANELLI ELASTICI TWO FIXED WHEELS WITH RETAINING RINGS	1
KR6805	MEMBRANA INGRASSATORE PNEUMATICO FOLLOWER PLATE OF AIR OPERATED PUMP	1
KR6807	SET VITI PER SERBATOIO SET OF SCREWS FOR RESERVOIR	1

ELENCO RICAMBI FORNIBILI SINGOLARMENTE

LIST OF SPARE PARTS WHICH CAN BE SUPPLIED SEPARATELY

CODICE CODE	DESCRIZIONE DESCRIPTION	Q.TÀ QTY
66888	PISTOLA GRASSO CON SNODO GREASE GUN WITH SWIVEL JOINT	1
66892	NIPPLE M 1/4" G x M 3/8" G NIPPLE M 1/4" G x M 3/8" G	1
993.504	TUBO 1/4" - 4 m - 600 bar HOSE 1/4" - 4 m - 600 bar	1
62041/A	POMPA GRASSO R 50:1 GREASE PUMP R 50:1	1
H086	O-RING 4118 O-RING 4118	2
H709	GUARNIZIONE DI TENUTA GASKET	1
KC093	MANICO HANDLE	1
KC125	SERBATOIO RESERVOIR	1
KC129	COPERCHIO COVER	1
N034	MOLLA PER MEMBRANA FOLLOWER PLATE SPRING	1

Art. KS6881

SET RICAMBI CONSIGLIATI

AI PUNTI VENDITA E ASSISTENZA.
COMPOSTO DAI RICAMBI SOTTO ELENCATI

SPARE PARTS KIT ADVISED

TO THE REPAIR CENTERS. THIS KIT INCLUDES ALL THE SPARE PARTS SHOWN HERE UNDER

CODICE CODE	DESCRIZIONE DESCRIPTION	Q.TÀ QTY
KS6280	POMPE GRASSO 50:1 GREASE PUMPS 50:1	1
KS6683	PISTOLA GRASSO CON SNODO GREASE GUN WITH SWIVEL	1

tutti i diritti riservati - all rights reserved



Art. 70365 Mod. VI65I



VISTA ESPLOSA - EXPLODED VIEW

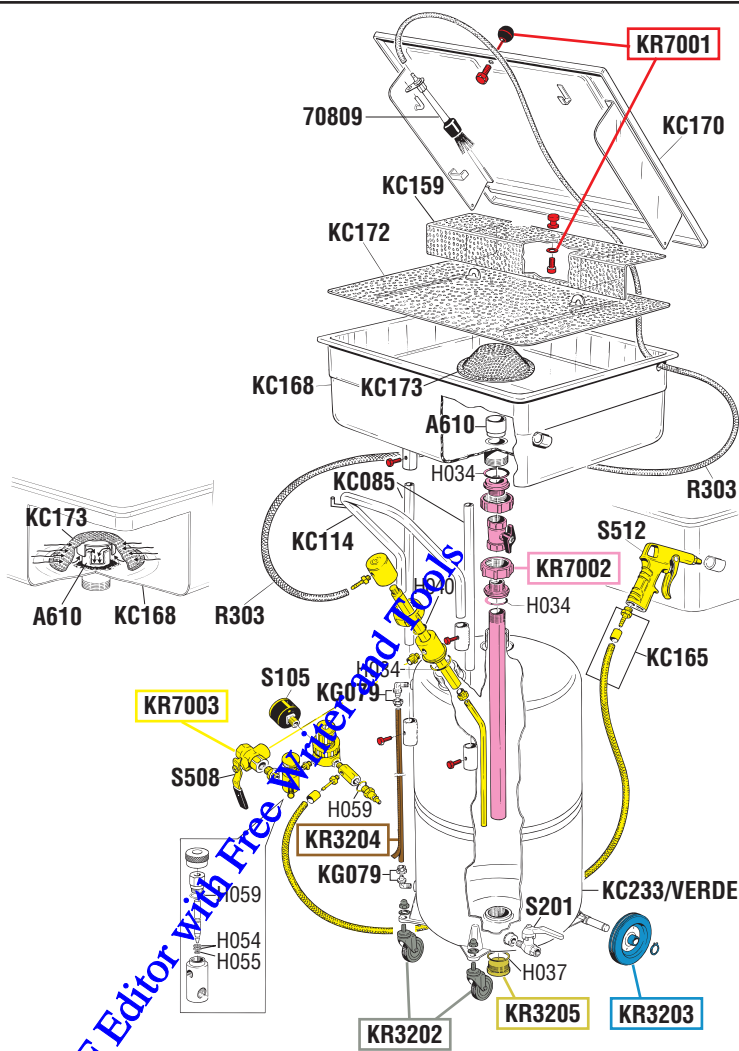

tutti i diritti riservati - all rights reserved

GUIDA RICAMBI - SPARE PARTS GUIDE

KIT RICAMBI
OGNI KIT SOTTO RIPORTATO COMPRENDE I RICAMBI EVIDENZIATI CON LO STESSO COLORE E LE RELATIVE GUARNIZIONI. QUESTI RICAMBI NON SONO FORNIBILI SEPARATAMENTE TRANNE QUELLI CODIFICATI.

SPARE PARTS KITS
EACH KIT SHOWN WITH THE SAME COLOR INCLUDES ALSO THE GASKETS. THE SPARE PARTS INCLUDED IN THE KIT CAN'T BE SUPPLIED SEPARATELY EXCEPT THOSE SHOWN WITH A PROPER CODE.

CODICE CODE	DESCRIZIONE DESCRIPTION	Q.TÀ QTY
KR3202	DUE RUOTE PIROETTANTI CON DADI TWO SWIVELLING WHEELS WITH NUTS	1
KR3203	2 RUOTE FISSE CON ANELLI ELASTICI 2 FIXED WHEELS WITH RETAINING RINGS	1
KR3204	TUBO DI LIVELLO ED ETICHETTA GAUGE TUBE AND LABEL	1
KR3205	TAPPO DI SCARICO DISCHARGING PLUG	1
KR7001	VITERIA SERBATOIO VASCA SET OF SCREWS FOR CLEANING TANK	1
KR7002	GRUPPO CENTRALE CENTRAL GROUP	1
KR7003	GRUPPO POMPA VASCA PUMP GROUP OF CLEANING TANK	1

ELENCO RICAMBI FORNIBILI SINGOLARMENTE
LIST OF SPARE PARTS WHICH CAN BE SUPPLIED SEPARATELY

CODICE CODE	DESCRIZIONE DESCRIPTION	Q.TÀ QTY
70809	PENNELLO BRUSH	1
A610	SIFONE VASCA EXTENSION	1
KC085	SUPPORTO VASCHE TANK SUPPORTS	2
KC114	MANICO A "U" HANDLE	1
KC159	GRIGLIA DI RIPIANO SHELF NET	1
KC165	TUBO COLLEGAMENTO PISTOLA ARIA AIR GUN CONNECTING HOSE	1
KC168	VASCA LAVAGGIO WASHING TANK	1
KC170	COPERCHIO VASCA TANK COVER	1
KC172	GRIGLIA VASCA TANK NET	1
KC173	GRIGLIA FILTRO FILTER NET	1
KC233/VERDE	SERBATOIO 65 l RESERVOIR 65 l	1
KG079	GRUPPO GOMITO E GHIERA RING AND ELBOW JOINT GROUP	1
R303	TUBO COLLEGAMENTO CONNECTING HOSE	1
S105	MANOMETRO ø 50 mm GAUGE ø 50 mm	1
S201	RUBINETTO A SFERA 1/4" BALL VALVE 1/4"	1
S508	RUBINETTO A SFERA BALL VALVE	1
S512	PISTOLA ARIA AIR GUN	1

Art. KR7050 **KIT GUARNIZIONI COMPLETO**
COMPOSTO DALLE GUARNIZIONI SOTTO ELENCAE
JOINTS GASKETS LIST
INCLUDING ALL THE GASKETS SHOWN HERE UNDER

CODICE CODE	DESCRIZIONE DESCRIPTION	Q.TÀ QTY
H034	O-RING 3156 O-RING 3156	3
H037	O-RING 3137 O-RING 3137	1
H040	O-RING 123 O-RING 123	1
H054	O-RING 2018 O-RING 2018	2
H055	O-RING 2010 O-RING 2010	1
H059	O-RING 2037 O-RING 2037	2

Art. KS7080 **SET RICAMBI CONSIGLIATI**
AI PUNTI VENDITA E ASSISTENZA,
COMPOSTO DAI RICAMBI SOTTO ELENCAE
SPARE PARTS KIT ADVISED
TO THE REPAIR CENTERS. THIS KIT INCLUDES
ALL THE SPARE PARTS SHOWN HERE UNDER

CODICE CODE	DESCRIZIONE DESCRIPTION	Q.TÀ QTY
70809	PENNELLO BRUSH	1
KR7050	KIT GUARNIZIONI COMPLETO COMPLETE GASKETS KIT	1
S105	MANOMETRO ø 50 mm GAUGE ø 50 mm	1



tecnologia qualità & funzionalità
 technology, quality, functionality

PDFFill PDF Editor with Free Writer and Tools

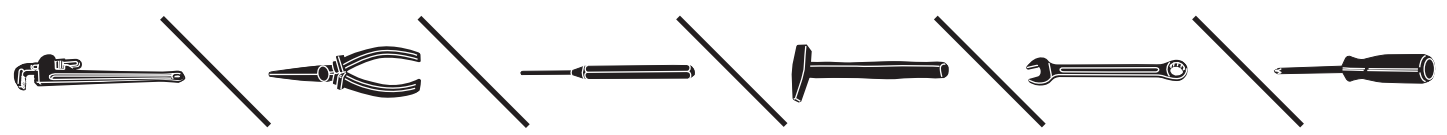



Art. 735000 Mod. 735-0-0-S50 - Art. 735111 - Art. 735112
 Art. 735131.60141 Mod. 735-R06-14-A10 - Art. 735131.60261 Mod. 735-R06-26-A10
 Art. 735131.60152 Mod. 735-R06-15-S50 - Art. 735131.60252 Mod. 735-R06-25-S50
 Art. 735141.60152 Mod. 735-A06-15-S50 - Art. 735141.60252 Mod. 735-A06-25-S50



VISTA ESPLOSA - EXPLODED VIEW



AVVOLGICAVO
 MESSA A TERRA
 GROUNDING REELS

Articolo completo Full Article	735131.60141
Ricambio / Spare	735113 - (14,5 m) con pinza antideflagrante with explosion proof clamp
Articolo completo Full Article	735131.60261
Ricambio / Spare	735114 - (26 m) con pinza antideflagrante with explosion proof clamp

Articolo completo Full Article	735131.60152
Cavo in Rame / Copper cable	71.1206150 - (15 m)
Articolo completo Full Article	735131.60252
Cavo in Rame / Copper cable	71.1206250 - (25 m)
Articolo completo Full Article	735141.60152
Cavo in Acciaio / Steel cable	71.2105150 - (15 m)
Articolo completo Full Article	735141.60252
Cavo in Acciaio / Steel cable	71.2105250 - (25 m)

735111	735112
50A	100A

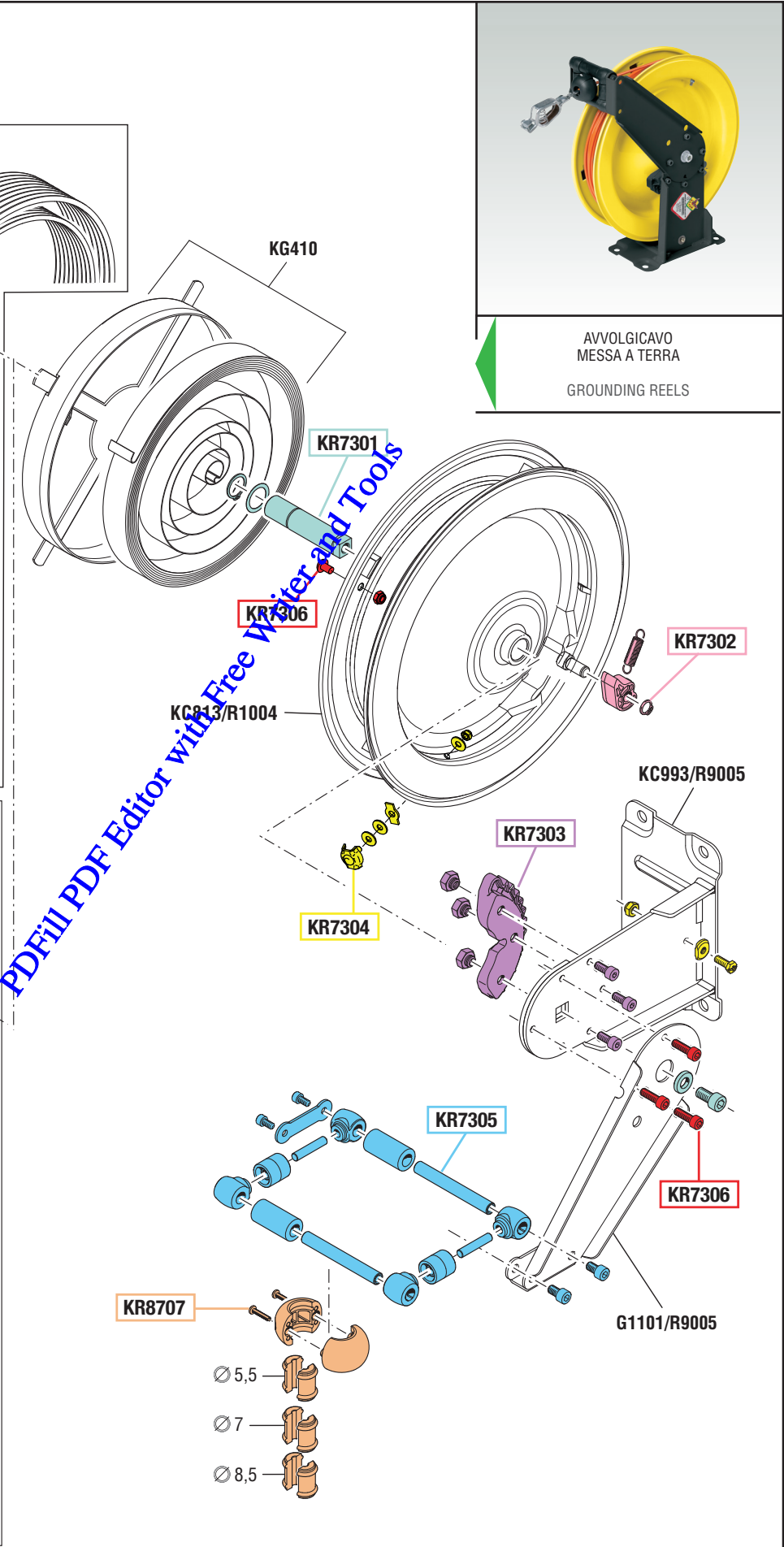

- Ø 5,5
- Ø 7
- Ø 8,5

tutti i diritti riservati - all rights reserved



GUIDA RICAMBI - SPARE PARTS GUIDE

KIT RICAMBI

OGNI KIT SOTTO RIPORTATO COMPRENDE I RICAMBI EVIDENZIATI CON LO STESSO COLORE E LE RELATIVE GUARNIZIONI. QUESTI RICAMBI NON SONO FORNIBILI SEPARATAMENTE TRANNE QUELLI CODIFICATI.

SPARE PARTS KITS

EACH KIT SHOWN WITH THE SAME COLOR INCLUDES ALSO THE GASKETS. THE SPARE PARTS INCLUDED IN THE KIT CAN'T BE SUPPLIED SEPARATELY EXCEPT THOSE SHOWN WITH A PROPER CODE.

CODICE CODE	DESCRIZIONE DESCRIPTION	Q. TÀ QTY
KR7301	KIT RICAMBIO PERNO TAMBURNO AVVOLGICAVO DRUM REPLACEMENT KIT PIN	1
KR7302	DENTE D'ARRESTO DETENT	1
KR7303	KIT CREMAGLIERA RACK KIT	1
KR7304	VITERIA FISSAGGIO PIASTRINA MESSA A TERRA SCREWS FIXING PLATE GROUNDING	1
KR7305	KIT PORTA RULLI AVVOLGICAVO ROLLERS HOLDING KIT FOR GROUNDING REELS	1
KR7306	VITERIA FISSAGGIO BRACCETTO MOUNTING BRACKET SCREWS	1
KR8707	TAMPONE FERMACAVO STOP CABLE BUFFER	1

ELENCO RICAMBI FORNIBILI SINGOLARMENTE

LIST OF SPARE PARTS WHICH CAN BE SUPPLIED SEPARATELY

CODICE CODE	DESCRIZIONE DESCRIPTION	Q. TÀ QTY
G1101/R9005	BRACCIO ORIENTABILE SWINGING ARM	1
KC993/R9005	STAFFA SOSTEGNO BRACKET	1
KC813/R1004	TAMBURNO AVVOLGICAVO REEL DRUM	1
KG410	GRUPPO CARTER MOBILE MOBILE HOUSING GROUP	1
71.1206150	CAVO IN RAME 15m - ISOLAMENTO "PUR" COPPER CABLE 15 m - "PUR" INSULATION	1
71.1206250	CAVO IN RAME 25m - ISOLAMENTO "PUR" COPPER CABLE 25 m - "PUR" INSULATION	1
71.2105150	CAVO IN ACCIAIO 15m - "PVC" ROSSO STEEL CABLE 15 m - "PVC" RED	1
71.2105250	CAVO IN ACCIAIO 25m - "PVC" ROSSO STEEL CABLE 25 m - "PVC" RED	1
735111	PINZA MESSA A TERRA 100 A CLIP GROUNDING 100 A	1
735112	PINZA MESSA A TERRA 50 A CLIP GROUNDING 50 A	1
735113	PINZA ISEO (ATEX) 1X14,5 CAVO 1X6 mq CLAMP ISEO (ATEX) 1X14,5 CABLE 1X6 mq	1
735114	PINZA ISEO (ATEX) 1X26 CAVO 1X6 mq CLAMP ISEO (ATEX) 1X26 CABLE 1X6 mq	1

PDFill PDF Editor with Free Writer and Tools



Art.7522001.100 Mod.752-RM-20bar-1” - Art.7532001.100 Mod.753-RM-20bar-1”
 Art.7522001.200 Mod.752-RM-100-1” - Art.7532001.200 Mod.753-RM-100-1”
 Art.7522001.400 Mod.752-RM-150-1” - Art.7532001.400 Mod.753-RM-150-1”



VISTA ESPLOSA - EXPLODED VIEW

VISTA ESPLOSA PER AVVOLGITUBO larghezza 240 mm e 320 mm
 Exploded view for hose reel width 240 mm and 320 mm

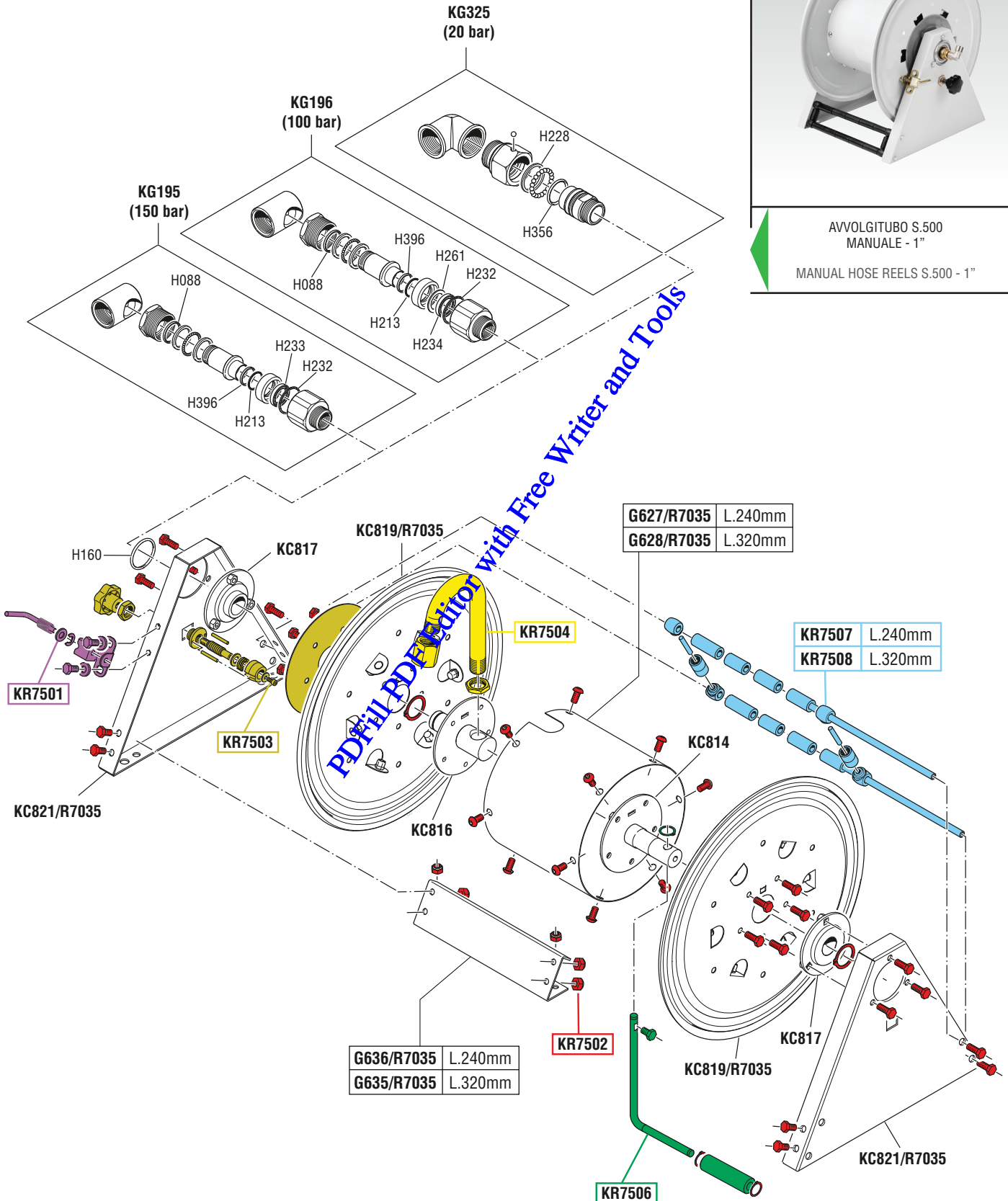

PDF Fill PDF Editor with Free Writer and Tools

tutti i diritti riservati - all rights reserved



GUIDA RICAMBI - SPARE PARTS GUIDE

KIT RICAMBI		
OGNI KIT SOTTO RIPIORTATO COMPRENDE I RICAMBI EVIDENZIATI CON LO STESSO COLORE E LE RELATIVE GUARNIZIONI. QUESTI RICAMBI NON SONO FORNIBILI SEPARATAMENTE TRANNE QUELLI CODIFICATI.		
SPARE PARTS KITS		
EACH KIT SHOWN WITH THE SAME COLOR INCLUDES ALSO THE GASKETS. THE SPARE PARTS INCLUDED IN THE KIT CAN'T BE SUPPLIED SEPARATELY EXCEPT THOSE SHOWN WITH A PROPER CODE.		
CODICE CODE	DESCRIZIONE DESCRIPTION	Q.TÀ QTY
KR7501	KIT FRENO AVVOLGITUBO MANUALE BREAK HOSE REEL MANUAL KIT	1
KR7502	SET VITI AVVOLGITUBO MANUALE SET OF SCREWS FOR MANUAL HOSE REEL	1
KR7503	KIT FRIZIONE CLUTCH KIT	1
KR7504	KIT TUBO DI RACCORDO PIPE FITTING KIT	1
KR7506	KIT MANOVELLA CRANK KIT	1
KR7507	KIT PORTA RULLI L = 240 mm ROLLERS HOLDING KIT L = 240 mm	1
KR7508	KIT PORTA RULLI L = 320 mm ROLLERS HOLDING KIT L = 320 mm	1

ELENCO RICAMBI FORNIBILI SINGOLARMENTE		
LIST OF SPARE PARTS WHICH CAN BE SUPPLIED SEPARATELY		
CODICE CODE	DESCRIZIONE DESCRIPTION	Q.TÀ QTY
G627/R7035	CILINDRO TAMBURIO (Art.7522001.100 - .200 - .400) BARREL DRUM (Art.7522001.100 - .200 - .400)	1
G628/R7035	CILINDRO TAMBURIO (Art.7532001.100 - .200 - .400) BARREL DRUM (Art.7532001.100 - .200 - .400)	1
G635/R7035	TRAVERSO (Art.7532001.100 - .200 - .400) SUPPORT (Art.7532001.100 - .200 - .400)	1
G636/R7035	TRAVERSO (Art.7522001.100 - .200 - .400) SUPPORT (Art.7522001.100 - .200 - .400)	1
KC814	PERNO CENTRALE LATO MANOVELLA CENTRAL SIDE CRANK PIN	1
KC816	PERNO CENTRALE LATO FRENO CENTRAL SIDE BRAKE PIN	1
KC817	SUPPORTO CON CUSCINETTO SUPPORT BEARING	1
KC819/R7035	CARTER TAMBURIO DRUM COVER	2
KC821/R7035	STAFFA SOSTEGNO AVVOLGITUBO HOSE REEL SUPPORT BRACKET	2
KG195	SNODO OLIO E AFFINI - 150 bar JOINT OIL AND SIMILAR 150 bar	1
KG196	SNODO ACQUA 130°C - 100 bar JOINT WATER MAX 130°C - 100 bar	1
KG325	SNODO ARIA - ACQUA - 20 bar JOINT AIR - WATER - 20 bar	1

ELENCO GUARNIZIONI SNODI		
JOINTS GASKETS LIST		
CODICE CODE	DESCRIZIONE DESCRIPTION	Q.TÀ QTY
H088	O-RING 2106 "NBR" O-RING 2106 "NBR"	1
H160	O-RING 2093 O-RING 2093	1
H213	O-RING 2087 "VITON" O-RING 2087 "VITON"	1
H228	O-RING 4112 "VITON" O-RING 4112 "VITON"	1
H232	O-RING 2131 O-RING 2131	1
H233	O-RING 3022 O-RING 3022	1
H234	O-RING 087 "VITON" O-RING 087 "VITON"	1
H261	RONDELLA IN "PTFE" PTFE WASHER	1
H356	O-RING 3106 "VITON" O-RING 3106 "VITON"	1
H396	RONDELLA IN "PTFE" PTFE WASHER	1

PDFfill PDF Editor with Free Writer and Tools



Art.7552001.100 Mod.755-RM-20bar-1" - Art.7562001.100 Mod.756-RM-20bar-1"
 Art.7552001.200 Mod.755-RM-100-1" - Art.7562001.200 Mod.756-RM-100-1"
 Art.7552001.400 Mod.755-RM-150-1" - Art.7562001.400 Mod.756-RM-150-1"



VISTA ESPLOSA - EXPLODED VIEW

VISTA ESPLOSA PER AVVOLGITUBO larghezza 460 mm e 600 mm
 Exploded view for hose reel width 460 mm and 600 mm

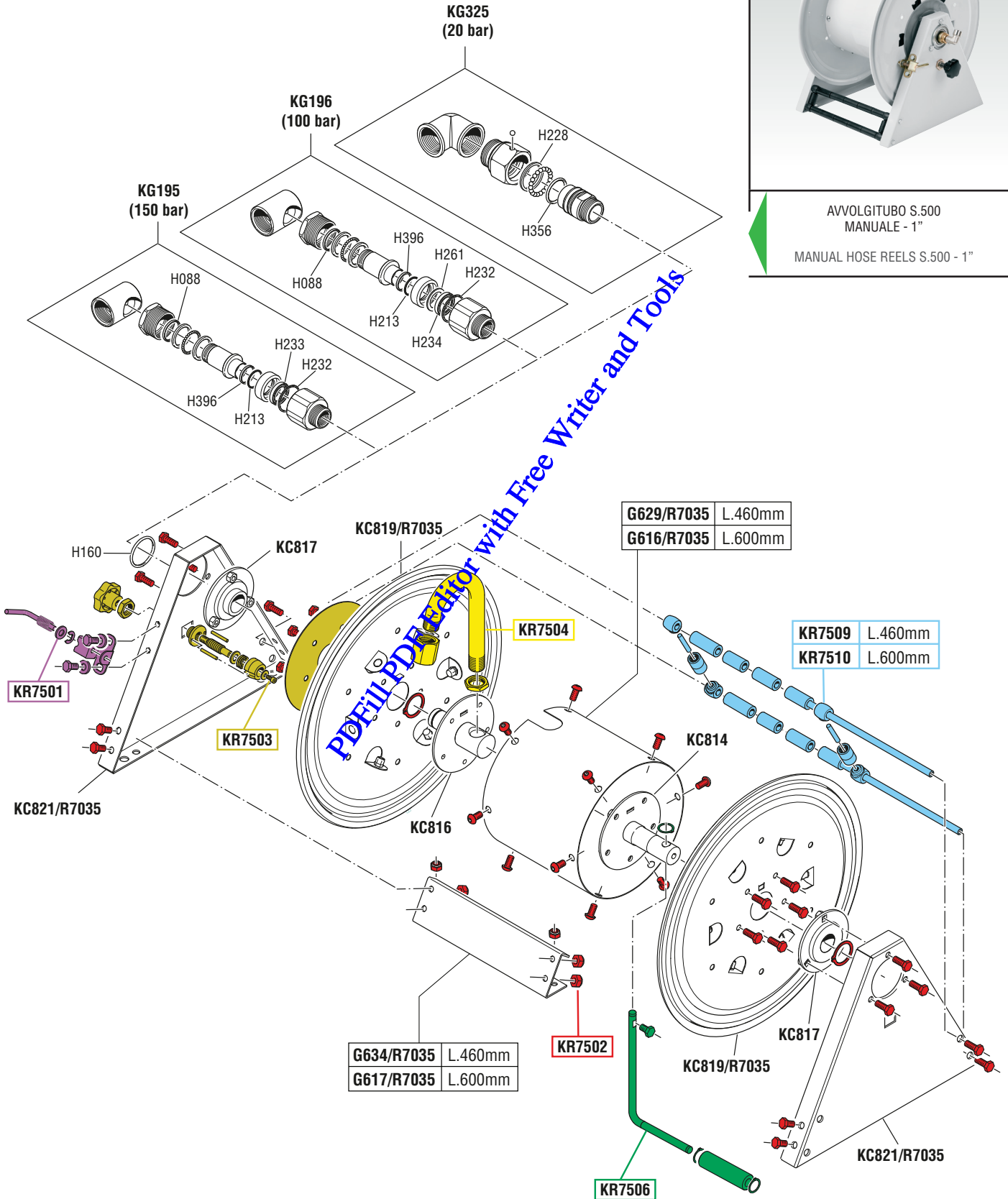

PDF Editor with Free Writer and Tools

tutti i diritti riservati - all rights reserved



GUIDA RICAMBI - SPARE PARTS GUIDE

KIT RICAMBI		
OGNI KIT SOTTO RIPORTATO COMPRENDE I RICAMBI EVIDENZIATI CON LO STESSO COLORE E LE RELATIVE GUARNIZIONI. QUESTI RICAMBI NON SONO FORNIBILI SEPARATAMENTE TRANNE QUELLI CODIFICATI.		
SPARE PARTS KITS		
EACH KIT SHOWN WITH THE SAME COLOR INCLUDES ALSO THE GASKETS. THE SPARE PARTS INCLUDED IN THE KIT CAN'T BE SUPPLIED SEPARATELY EXCEPT THOSE SHOWN WITH A PROPER CODE.		
CODICE CODE	DESCRIZIONE DESCRIPTION	Q.TÀ QTY
KR7501	KIT FRENO AVVOLGITUBO MANUALE BREAK HOSE REEL MANUAL KIT	1
KR7502	SET VITI AVVOLGITUBO MANUALE SET OF SCREWS FOR MANUAL HOSE REEL	1
KR7503	KIT FRIZIONE CLUTCH KIT	1
KR7504	KIT TUBO DI RACCORDO PIPE FITTING KIT	1
KR7506	KIT MANOVELLA CRANK KIT	1
KR7509	KIT PORTA RULLI L = 460 mm ROLLERS HOLDING KIT L = 460 mm	1
KR7510	KIT PORTA RULLI L = 600 mm ROLLERS HOLDING KIT L = 600 mm	1

ELENCO RICAMBI FORNIBILI SINGOLARMENTE		
LIST OF SPARE PARTS WHICH CAN BE SUPPLIED SEPARATELY		
CODICE CODE	DESCRIZIONE DESCRIPTION	Q.TÀ QTY
G616/R7035	CILINDRO TAMBURIO (Art.7562001.100 - 200 - 400) BARREL DRUM (Art.7562001.100 - 200 - 400)	1
G617/R7035	TRAVERSO (Art.7562001.100 - 200 - 400) SUPPORT (Art.7562001.100 - 200 - 400)	1
G629/R7035	CILINDRO TAMBURIO (Art.7552001.100 - 200 - 400) BARREL DRUM (Art.7552001.100 - 200 - 400)	1
G634/R7035	TRAVERSO (Art.7552001.100 - 200 - 400) SUPPORT (Art.7552001.100 - 200 - 400)	1
KC814	PERNO CENTRALE LATO MANOVELLA CENTRAL SIDE CRANK PIN	1
KC816	PERNO CENTRALE LATO FRENO CENTRAL SIDE BRAKE PIN	1
KC817	SUPPORTO CON CUSCINETTO SUPPORT BEARING	1
KC819/R7035	CARTER TAMBURIO DRUM COVER	2
KC821/R7035	STAFFA SOSTEGNO AVVOLGITUBO HOSE REEL SUPPORT BRACKET	2
KG195	SNODO OLIO E AFFINI - 150 bar JOINT OIL AND SIMILAR 150 bar	1
KG196	SNODO ACQUA 130°C - 100 bar JOINT WATER MAX 130°C - 100 bar	1
KG325	SNODO ARIA - ACQUA - 20 bar JOINT AIR - WATER - 20 bar	1

ELENCO GUARNIZIONI SNODI		
JOINTS GASKETS LIST		
CODICE CODE	DESCRIZIONE DESCRIPTION	Q.TÀ QTY
H088	O-RING 2106 "NBR" O-RING 2106 "NBR"	1
H160	O-RING 2093 O-RING 2093	1
H213	O-RING 2087 "VITON" O-RING 2087 "VITON"	1
H228	O-RING 4112 "VITON" O-RING 4112 "VITON"	1
H232	O-RING 2131 O-RING 2131	1
H233	O-RING 3022 O-RING 3022	1
H234	O-RING 087 "VITON" O-RING 087 "VITON"	1
H261	RONDELLA IN "PTFE" PTFE WASHER	1
H356	O-RING 3106 "VITON" O-RING 3106 "VITON"	1
H396	RONDELLA IN "PTFE" PTFE WASHER	1

PDFill PDF Editor with Free Writer and Tools

RAASM

FLUIDS AND LUBRICATION EQUIPMENT



Art.7522001.150 Mod.752-RM-20bar-1/2" - Art.7532001.150 Mod.753-RM-20bar-1/2"
 Art.7522001.250 Mod.752-RM-100bar-1/2" - Art.7532001.250 Mod.753-RM-100bar-1/2"
 Art.7522001.300 Mod.752-RM-200bar-1/2" - Art.7532001.300 Mod.753-RM-200bar-1/2"
 Art.7522001.450 Mod.752-RM-150bar-1/2" - Art.7532001.450 Mod.753-RM-150bar-1/2"



VISTA ESPLOSA - EXPLODED VIEW

VISTA ESPLOSA PER AVVOLGITUBO larghezza 240 mm e 320 mm
 Exploded view for hose reel width 240 mm and 320 mm

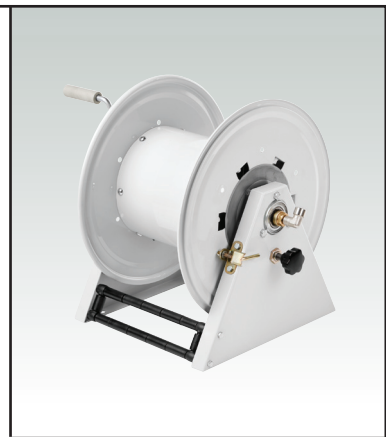

AVVOLGITUBO S.500
 MANUALE - 1/2"
 MANUAL HOSE REELS S.500 - 1/2"

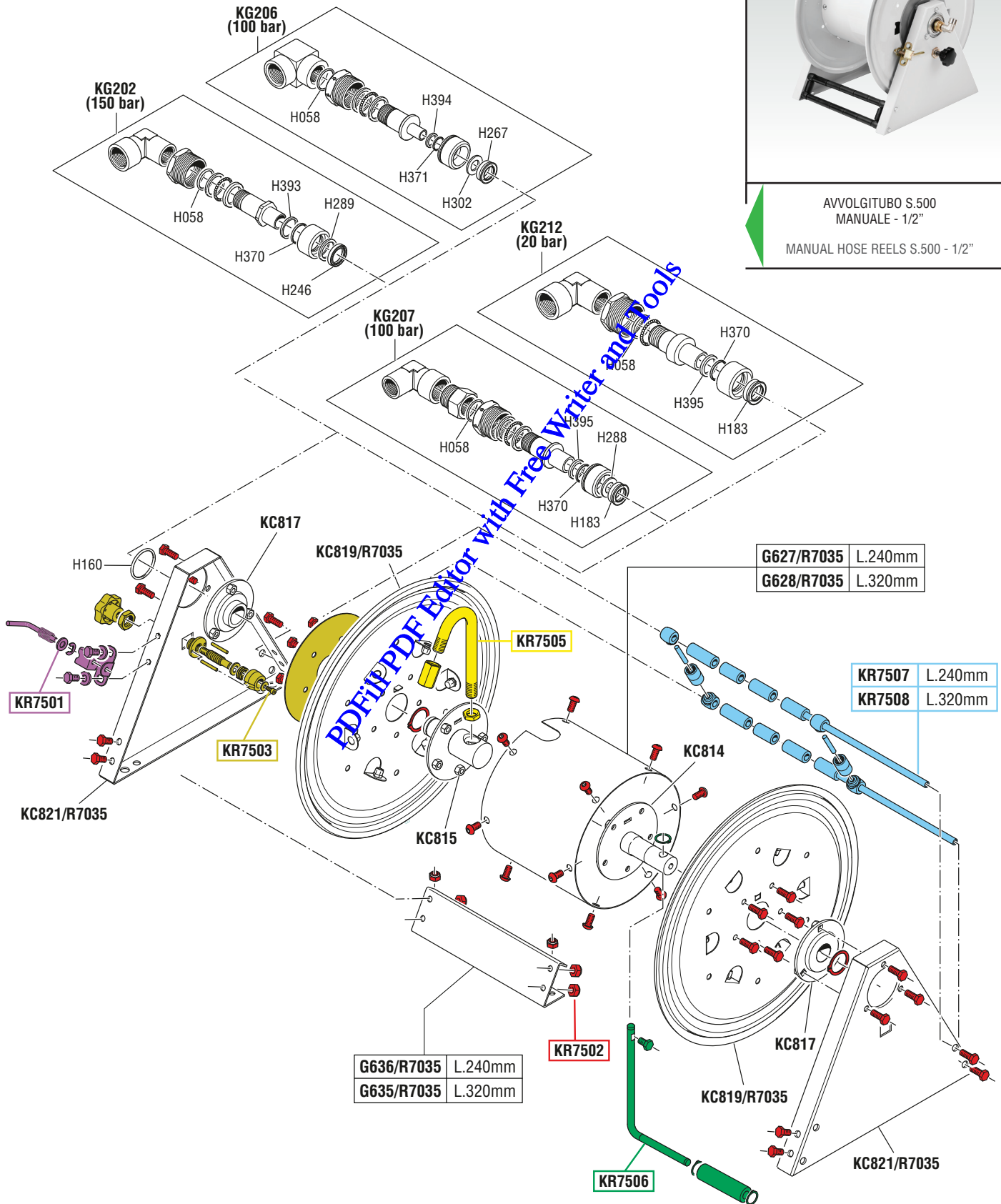

tutti i diritti riservati - all rights reserved



GUIDA RICAMBI - SPARE PARTS GUIDE

KIT RICAMBI
OGNI KIT SOTTO RIPORTATO COMPRENDE I RICAMBI EVIDENZIATI CON LO STESSO COLORE E LE RELATIVE GUARNIZIONI. QUESTI RICAMBI NON SONO FORNIBILI SEPARATAMENTE TRANNE QUELLI CODIFICATI.

SPARE PARTS KITS

EACH KIT SHOWN WITH THE SAME COLOR INCLUDES ALSO THE GASKETS. THE SPARE PARTS INCLUDED IN THE KIT CAN'T BE SUPPLIED SEPARATELY EXCEPT THOSE SHOWN WITH A PROPER CODE.

CODICE CODE	DESCRIZIONE DESCRIPTION	Q.TÀ QTY
KR7501	KIT FRENO AVVOLGITUBO MANUALE BREAK HOSE REEL MANUAL KIT	1
KR7502	SET VITI AVVOLGITUBO MANUALE SET OF SCREWS FOR MANUAL HOSE REEL	1
KR7503	KIT FRIZIONE CLUTCH KIT	1
KR7505	KIT TUBO DI RACCORDO PIPE FITTING KIT	1
KR7506	KIT MANOVELLA CRANK KIT	1
KR7507	KIT PORTA RULLI L = 240 mm ROLLERS HOLDING KIT L = 240 mm	1
KR7508	KIT PORTA RULLI L = 320 mm ROLLERS HOLDING KIT L = 320 mm	1

ELENCO RICAMBI FORNIBILI SINGOLARMENTE

LIST OF SPARE PARTS WHICH CAN BE SUPPLIED SEPARATELY

CODICE CODE	DESCRIZIONE DESCRIPTION	Q.TÀ QTY
G627/R7035	CILINDRO TAMBURO (Art.7522001.150-250-300-450) BARREL DRUM (Art.7522001.150-250-300-450)	1
G628/R7035	CILINDRO TAMBURO (Art.7532001.150-250-300-450) BARREL DRUM (Art.7532001.150-250-300-450)	1
G635/R7035	TRAVERSO (Art.7532001.150-250-300-450) SUPPORT (Art.7532001.150-250-300-450)	1
G636/R7035	TRAVERSO (Art.7522001.150-250-300-450) SUPPORT (Art.7522001.150-250-300-450)	1
KC814	PERNO CENTRALE LATO MANOVELLA CENTRAL SIDE CRANK PIN	1
KC815	PERNO CENTRALE LATO FRENO CENTRAL SIDE BRAKE PIN	1
KC817	SUPPORTO CON CUSCINETTO SUPPORT BEARING	1
KC819/R7035	CARTER TAMBURO DRUM COVER	2
KC821/R7035	STAFFA SOSTEGNO AVVOLGITUBO HOSE REEL SUPPORT BRACKET	2
KG202	SNODO OLIO - 150 bar JOINT OIL - 150 bar	1
KG206	SNODO ARIA - ACQUA - 20 bar JOINT AIR - WATER - 20 bar	1
KG207	SNODO ACQUA - 100 bar JOINT WATER - 100 bar	1
KG212	SNODO ARIA - ACQUA - 20 bar JOINT AIR WATER - 20 bar	1

ELENCO GUARNIZIONI SNODI

JOINTS GASKETS LIST

CODICE CODE	DESCRIZIONE DESCRIPTION	Q.TÀ QTY
H058	O-RING 2068 O-RING 2068	1
H246	GUARNIZIONE MAD 2060/2 GASKET MAD 2060/2	1
H267	O-RING "VITON" O-RING "VITON"	1
H289	RONDELLA IN "PTFE" PTFE WASHER	1
H302	RONDELLA IN "PTFE" PTFE WASHER	1
H370	O-RING 2062 "VITON" O-RING 2062 "VITON"	1
H371	O-RING 2037 "VITON" O-RING 2037 "VITON"	1
H393	RONDELLA IN "PTFE" PTFE WASHER	1
H394	RONDELLA IN "PTFE" PTFE WASHER	1

PDFfill PDF Editor with Free Writer and Tools

RAASM

FLUIDS AND LUBRICATION EQUIPMENT



GUIDA RICAMBI - SPARE PARTS GUIDE

KIT RICAMBI		
OGNI KIT SOTTO RIPORTATO COMPRENDE I RICAMBI EVIDENZIATI CON LO STESSO COLORE E LE RELATIVE GUARNIZIONI. QUESTI RICAMBI NON SONO FORNIBILI SEPARATAMENTE TRANNE QUELLI CODIFICATI.		
SPARE PARTS KITS		
EACH KIT SHOWN WITH THE SAME COLOR INCLUDES ALSO THE GASKETS. THE SPARE PARTS INCLUDED IN THE KIT CAN'T BE SUPPLIED SEPARATELY EXCEPT THOSE SHOWN WITH A PROPER CODE.		
CODICE CODE	DESCRIZIONE DESCRIPTION	Q.TÀ QTY
KR7501	KIT FRENO AVVOLGITUBO MANUALE BREAK HOSE REEL MANUAL KIT	1
KR7502	SET VITI AVVOLGITUBO MANUALE SET OF SCREWS FOR MANUAL HOSE REEL	1
KR7503	KIT FRIZIONE CLUTCH KIT	1
KR7505	KIT TUBO DI RACCORDO PIPE FITTING KIT	1
KR7506	KIT MANOVELLA CRANK KIT	1
KR7509	KIT PORTA RULLI L = 460 mm ROLLERS HOLDING KIT L = 460 mm	1
KR7510	KIT PORTA RULLI L = 600 mm ROLLERS HOLDING KIT L = 600 mm	1

ELENCO RICAMBI FORNIBILI SINGOLARMENTE		
LIST OF SPARE PARTS WHICH CAN BE SUPPLIED SEPARATELY		
CODICE CODE	DESCRIZIONE DESCRIPTION	Q.TÀ QTY
G616/R7035	CILINDRO TAMBURIO (Art.7562001.150-250-300-450) BARREL DRUM (Art.7562001.150-250-300-450)	1
G617/R7035	TRAVERSO (Art.7562001.150-250-300-450) SUPPORT (Art.7562001.150-250-300-450)	1
G629/R7035	CILINDRO TAMBURIO (Art.7552001.150-250-300-450) BARREL DRUM (Art.7552001.150-250-300-450)	1
G634/R7035	TRAVERSO (Art.7552001.150-250-300-450) SUPPORT (Art.7552001.150-250-300-450)	1
KC814	PERNO CENTRALE LATO MANOVELLA CENTRAL SIDE CRANK PIN	1
KC815	PERNO CENTRALE LATO FRENO CENTRAL SIDE BRAKE PIN	1
KC817	SUPPORTO CON CUSCINETTO SUPPORT BEARING	1
KC819/R7035	CARTER TAMBURIO DRUM COVER	2
KC821/R7035	STAFFA SOSTEGNO AVVOLGITUBO HOSE REEL SUPPORT BRACKET	2
KG202	SNODO OLIO - 150 bar JOINT OIL - 150 bar	1
KG206	SNODO ARIA - ACQUA - 20 bar JOINT AIR - WATER - 20 bar	1
KG207	SNODO ACQUA - 100 bar JOINT WATER - 100 bar	1
KG212	SNODO ARIA - ACQUA - 20 bar JOINT AIR WATER - 20 bar	1

ELENCO GUARNIZIONI SNODI		
JOINTS GASKETS LIST		
CODICE CODE	DESCRIZIONE DESCRIPTION	Q.TÀ QTY
H058	O-RING 2068 O-RING 2068	1
H246	GUARNIZIONE MAD 2060/2 GASKET MAD 2060/2	1
H267	O-RING "VITON" O-RING "VITON"	1
H289	RONDELLA IN "PTFE" PTFE WASHER	1
H302	RONDELLA IN "PTFE" PTFE WASHER	1
H370	O-RING 2062 "VITON" O-RING 2062 "VITON"	1
H371	O-RING 2037 "VITON" O-RING 2037 "VITON"	1
H393	RONDELLA IN "PTFE" PTFE WASHER	1
H394	RONDELLA IN "PTFE" PTFE WASHER	1

PDFfill PDF Editor with Free Writer and Tools



GUIDA RICAMBI - SPARE PARTS GUIDE

KIT RICAMBI		
OGNI KIT SOTTO RIPORTATO COMPRENDE I RICAMBI EVIDENZIATI CON LO STESSO COLORE E LE RELATIVE GUARNIZIONI. QUESTI RICAMBI NON SONO FORNIBILI SEPARATAMENTE TRANNE QUELLI CODIFICATI.		
SPARE PARTS KITS		
EACH KIT SHOWN WITH THE SAME COLOR INCLUDES ALSO THE GASKETS. THE SPARE PARTS INCLUDED IN THE KIT CAN'T BE SUPPLIED SEPARATELY EXCEPT THOSE SHOWN WITH A PROPER CODE.		
CODICE CODE	DESCRIZIONE DESCRIPTION	Q.TÀ QTY
KR7701	KIT BOCCOLA SOSTEGNO TAMBURO BUSH DRUM SUPPORT KIT	1
KR7702	KIT SUPPORTO PER MANOVELLA SUPPORT KIT FOR CRANK	1
KR7703	KIT FRIZIONE CLUTCH KIT	1
KR7704	KIT CREMAGLIERA RIAVVOLGIMENTO RACK MANUAL REWIND KIT	1
KR7705	KIT SUPPORTO PIGNONE PINION KIT SUPPORT	1
KR7706	KIT PERNO PIGNONE PINION SHAFT KIT	1
KR7707	KIT MANOVELLA CRANK KIT	1
KR7708	SET VITI AVVOLGITUBO MANUALE SET OF SCREWS FOR MANUAL HOSE REEL	1

ELENCO RICAMBI FORNIBILI SINGOLARMENTE		
LIST OF SPARE PARTS WHICH CAN BE SUPPLIED SEPARATELY		
CODICE CODE	DESCRIZIONE DESCRIPTION	Q.TÀ QTY
77/00M	RECUPERO MANUALE MANUAL RECOVERY	1
77/1F	BLOCCO TAMBURO (FRENO) DRUM LOCK	1
G340/R7035	CILINDRO TAMBURO (Art.7721001.100 - .400) BARREL DRUM (Art.7721001.100 - .400)	1
G341/R7035	TRAVERSO POSTERIORE (Art.7721001.100 - .400) BACK SUPPORT (Art.7721001.100 - .400)	1
G342/R7035	TRAVERSO ANTERIORE (Art.7721001.100 - .400) FRONT SUPPORT (Art.7721001.100 - .400)	1
G372/R7035	CILINDRO TAMBURO (Art.7771001.100 - .400) BARREL DRUM (Art.7771001.100 - .400)	1
G373/R7035	TRAVERSO POSTERIORE (Art.7771001.100 - .400) BACK SUPPORT (Art.7771001.100 - .400)	1
G374/R7035	TRAVERSO ANTERIORE (Art.7771001.100 - .400) FRONT SUPPORT (Art.7771001.100 - .400)	1
G376/R7035	TRAVERSO POSTERIORE (Art.7741001.100 - .400) BACK SUPPORT (Art.7741001.100 - .400)	1
G377/R7035	TRAVERSO ANTERIORE (Art.7741001.100 - .400) FRONT SUPPORT (Art.7741001.100 - .400)	1
G436/R7035	STAFFA DI SOLLEVAMENTO LIFTING BRACKET	2
G484/R7035	TRAVERSO POSTERIORE (Art.7751001.100 - .400) BACK SUPPORT (Art.7751001.100 - .400)	1
G485/R7035	TRAVERSO ANTERIORE (Art.7751001.100 - .400) FRONT SUPPORT (Art.7751001.100 - .400)	1
G486/R7035	CILINDRO TAMBURO (Art.7741001.100 - .400) BARREL DRUM (Art.7741001.100 - .400)	1
G487/R7035	CILINDRO TAMBURO (Art.7751001.100 - .400) BARREL DRUM (Art.7751001.100 - .400)	1
G626/R7035	CARTER DI PROTEZIONE GUARD	1
G739/R7035	CARTER PROTEZIONE PIGNONE SPROCKET GUARD	1
G889/R7035	LAMIERINO PER COPERTURA FORI PLATE TO COVER HOLES	2
KC702	PERNO CENTRALE (Art.771001.100 - .400) CENTRAL PIVOT (Art.771001.100 - .400)	1
KC703	PERNO CENTRALE (Art.7771001.100 - .400) CENTRAL PIVOT (Art.7771001.100 - .400)	1
KC717/R7035	CARTER TAMBURO DRUM COVER	2
KC750	PERNO CENTRALE (Art.7741001.100 - .400) CENTRAL PIVOT (Art.7741001.100 - .400)	1
KC751	PERNO CENTRALE (Art.7751001.100 - .400) CENTRAL PIVOT (Art.7751001.100 - .400)	1
KC762/R7035	AVVOLGITUBO ARROTOLATORE HOSE GUIDE	1
KC804/R7035	STAFFA SOSTEGNO LATO BLOCCO BRACKET SIDE BLOCK	1
KC808/R7035	STAFFA SOSTEGNO LATO MOTORE BRACKET ON THE MOTOR SIDE	1
KC817	SUPPORTO CON CUSCINETTO SUPPORT BEARING	1
KG326	SNODO ARIA-ACQUA - 20 bar JOINT AIR-WATER 20 bar	1
KG330	SNODO OLIO-AFFINI - 70 bar JOINT OIL AND SIMILAR - 70 bar	1
P226	PIGNONE CONICO BEVEL PINION	1

ELENCO GUARNIZIONI SNODI		
JOINTS GASKETS LIST		
CODICE CODE	DESCRIZIONE DESCRIPTION	Q.TÀ QTY
H226	O-RING 155 "VITON" O-RING 155 "VITON"	1
H572	ANELLO ANTIESTRUSIONE BACKUP RING	1
H573	O-RING 3218 "VITON" O-RING 3218 "VITON"	1



Art. 7721301.100 Mod.772-E24V-20bar - Art. 7721301.400 Mod.772-E24V-70bar
 Art. 7741301.100 Mod.774-E24V-20bar - Art. 7741301.400 Mod.774-E24V-70bar
 Art. 7751301.100 Mod.775-E24V-20bar - Art. 7751301.400 Mod.775-E24V-70bar
 Art. 7771301.100 Mod.777-E24V-20bar - Art. 7771301.400 Mod.777-E24V-70bar



VISTA ESPLOSA - EXPLODED VIEW

N.b. Gli avvolgitubo elettrici 24V S.700 oltre ad essere disponibili in 4 larghezze diverse (vedi note sotto riportate) possono montare 6 bocchette guidatubo differenti per tipo e posizione di montaggio (vedi esplosio ricambi specifico bocchette guidatubo)

The S.700 electric 24V hose reels to be over available in 4 different widths (see note below) may fit different hose guide 6 ports by type and location of assembly (see specific spare parts jets hose guide)

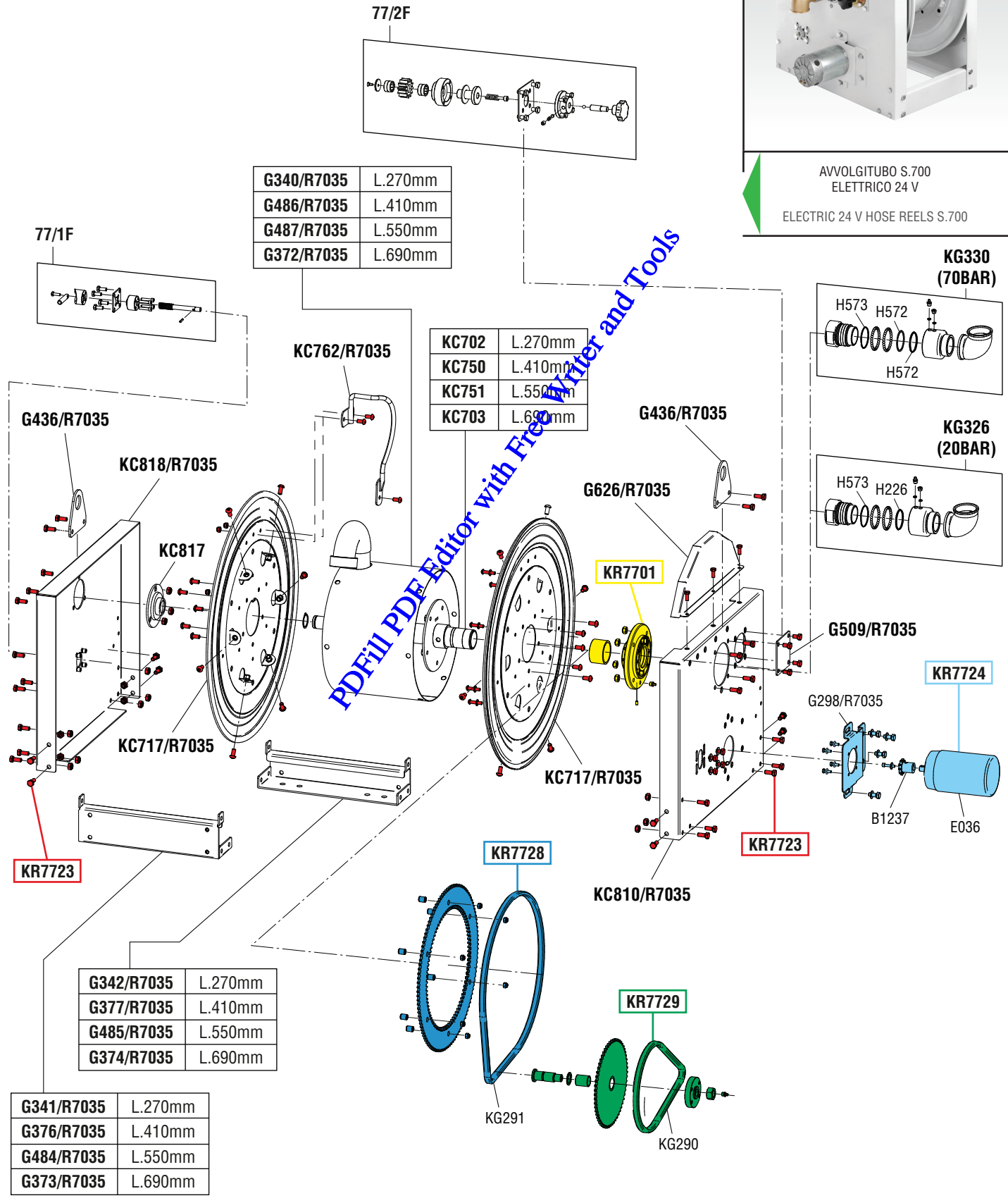
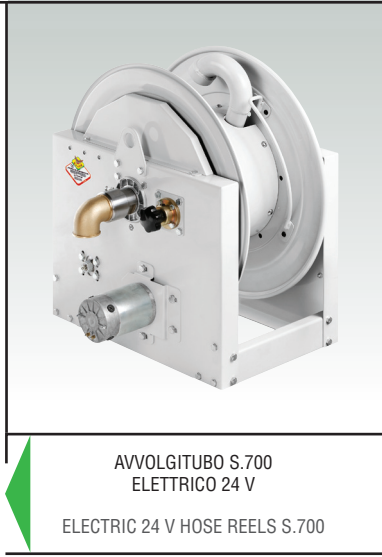

tutti i diritti riservati - all rights reserved

GUIDA RICAMBI - SPARE PARTS GUIDE

KIT RICAMBI		
OGNI KIT SOTTO RIPORTATO COMPRENDE I RICAMBI EVIDENZIATI CON LO STESSO COLORE E LE RELATIVE GUARNIZIONI. QUESTI RICAMBI NON SONO FORNIBILI SEPARATAMENTE TRANNE QUELLI CODIFICATI.		
SPARE PARTS KITS		
EACH KIT SHOWN WITH THE SAME COLOR INCLUDES ALSO THE GASKETS. THE SPARE PARTS INCLUDED IN THE KIT CAN'T BE SUPPLIED SEPARATELY EXCEPT THOSE SHOWN WITH A PROPER CODE.		
CODICE CODE	DESCRIZIONE DESCRIPTION	Q.TÀ QTY
KR7701	KIT BOCCOLA SOSTEGNO TAMBUR BUSH DRUM SUPPORT KIT	1
KR7723	SET VITI AVVOLGITUBO SET OF SCREWS	1
KR7724	KIT MOTORE 24 Vdc MOTOR KIT 24 Vdc	1
KR7728	KIT RIDUTTORE A RINVIO (Z1.114) REFERENCE GEARBOX (Z1.114)	1
KR7729	KIT RIDUTTORE A RINVIO (Z2.14) REFERENCE GEARBOX (Z2.14)	1

ELENCO RICAMBI FORNIBILI SINGOLARMENTE		
LIST OF SPARE PARTS WHICH CAN BE SUPPLIED SEPARATELY		
CODICE CODE	DESCRIZIONE DESCRIPTION	Q.TÀ QTY
77/1F	BLOCCO TAMBUR DRUM LOCK	1
77/2F	FRENO FRIZIONE BRAKE CLUTCH	1
B1237	PIGNONE DENTATO MOTORE MOTOR PINION	1
E036	MOTORE 24 Vdc MOTOR 24 Vdc	1
G298/R7035	STAFFA SUPPORTO MOTORE MOTOR SUPPORT BRACKET	1
G340/R7035	CILINDRO TAMBUR (Art.7721301.100 - 400) BARREL DRUM (Art.7721301.100 - 400)	1
G341/R7035	TRAVERSO POSTERIORE (Art.7721301.100 - 400) BACK SUPPORT (Art.7721301.100 - 400)	1
G342/R7035	TRAVERSO ANTERIORE (Art.7721301.100 - 400) FRONT SUPPORT (Art.7721301.100 - 400)	1
G372/R7035	CILINDRO TAMBUR (Art.7771301.100 - 400) BARREL DRUM (Art.7771301.100 - 400)	1
G373/R7035	TRAVERSO POSTERIORE (Art.7771301.100 - 400) BACK SUPPORT (Art.7771301.100 - 400)	1
G374/R7035	TRAVERSO ANTERIORE (Art.7771301.100 - 400) FRONT SUPPORT (Art.7771301.100 - 400)	1
G376/R7035	TRAVERSO POSTERIORE (Art.7741301.100 - 400) BACK SUPPORT (Art.7741301.100 - 400)	1
G377/R7035	TRAVERSO ANTERIORE (Art.7741301.100 - 400) FRONT SUPPORT (Art.7741301.100 - 400)	1
G436/R7035	STAFFA DI SOLLEVAMENTO LIFTING BRACKET	2
G484/R7035	TRAVERSO POSTERIORE (Art.7751301.100 - 400) BACK SUPPORT (Art.7751301.100 - 400)	1
G485/R7035	TRAVERSO ANTERIORE (Art.7751301.100 - 400) FRONT SUPPORT (Art.7751301.100 - 400)	1
G486/R7035	CILINDRO TAMBUR (Art.7741301.100 - 400) BARREL DRUM (Art.7741301.100 - 400)	1
G487/R7035	CILINDRO TAMBUR (Art.7751301.100 - 400) BARREL DRUM (Art.7751301.100 - 400)	1
G509/R7035	PIASTRA CIECA BLANKING PLATE	1
G626/R7035	CARTER DI PROTEZIONE GUARD	1
KC702	PERNO CENTRALE (Art.7721301.100 - 400) CENTRAL PIVOT (Art. 7721301.100 - 400)	1
KC703	PERNO CENTRALE (Art.7771301.100 - 400) CENTRAL PIVOT (Art. 7771301.100 - 400)	1
KC717/R7035	CARTER TAMBUR DRUM COVER	2
KC750	PERNO CENTRALE (Art.7741301.100 - 400) CENTRAL PIVOT (Art. 7741301.100 - 400)	1
KC751	PERNO CENTRALE (Art.7751301.100 - 400) CENTRAL PIVOT (Art. 7751301.100 - 400)	1
KC762/R7035	GUIDATUBO ARROTOLATORE HOSE GUIDE	1
KC810/R7035	STAFFA SOSTEGNO LATO MOTORE BRACKET ON THE MOTOR SIDE	1
KG817	SUPPORTO CON CUSCINETTO SUPPORT BEARING	1
KG818/R7035	STAFFA SOSTEGNO LATO BLOCCO BRACKET SIDE BLOCK	1
KG290	CATENA MOTORE RINVIO CHAIN REFERRAL MOTOR	1
KG291	CATENA RINVIO TAMBUR REFERRAL CHAIN DRUM	1
KG326	SNODO ARIA-ACQUA - 20 bar JOINT AIR-WATER 20 bar	1
KG330	SNODO OLIO-AFFINI - 70 bar JOINT OIL AND SIMILAR - 70 bar	1

ELENCO GUARNIZIONI SNODI		
JOINTS GASKETS LIST		
CODICE CODE	DESCRIZIONE DESCRIPTION	Q.TÀ QTY
H226	O-RING 155 "VITON" O-RING 155 "VITON"	1
H572	ANELLO ANTIESTRUSIONE BACKUP RING	1
H573	O-RING 3218 "VITON" O-RING 3218 "VITON"	1



Art. 7721601.100 Mod.772-E230V-20bar - Art. 7721601.400 Mod.772-E230V-70bar
 Art. 7741601.100 Mod.774-E230V-20bar - Art. 7741601.400 Mod.774-E230V-70bar
 Art. 7751601.100 Mod.775-E230V-20bar - Art. 7751601.400 Mod.775-E230V-70bar
 Art. 7771601.100 Mod.777-E230V-20bar - Art. 7771601.400 Mod.777-E230V-70bar



VISTA ESPLOSA - EXPLODED VIEW

N.b. Gli avvolgitubo elettrici 230V S.700 oltre ad essere disponibili in 4 larghezze diverse (vedi note sotto riportate) possono montare 6 bocchette guidatubo differenti per tipo e posizione di montaggio (vedi esplosio ricambi specifico bocchette guidatubo)

The S.700 electric 230V hose reels to be over available in 4 different widths (see note below) may fit different hose guide 6 ports by type and location of assembly (see specific spare parts jets hose guide)



AVVOLGITUBO S.700
 ELETTRICO 230V
 ELECTRIC 230V HOSE REELS S.700

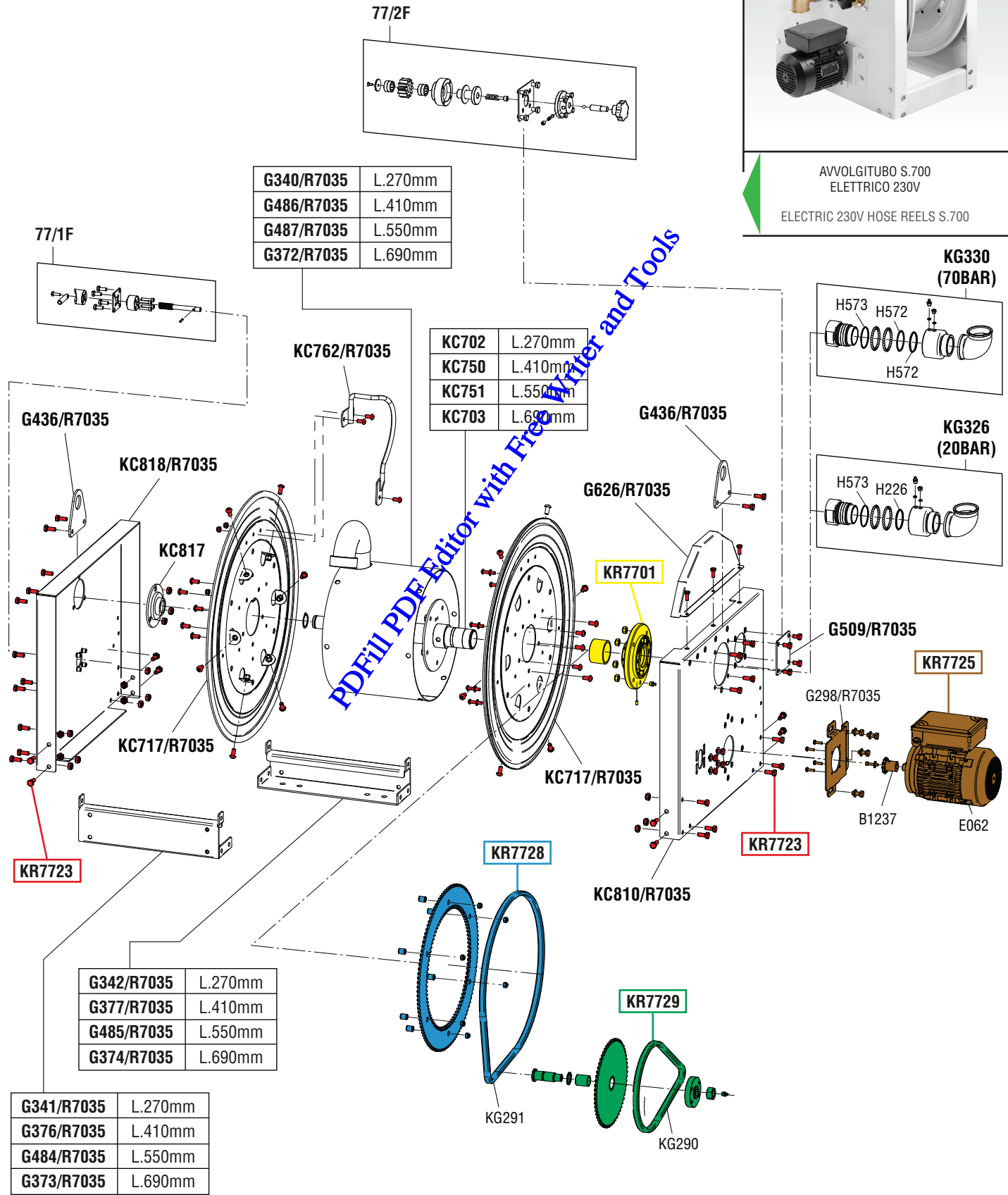

tutti i diritti riservati - all rights reserved

GUIDA RICAMBI - SPARE PARTS GUIDE

KIT RICAMBI		
OGNI KIT SOTTO RIPORTATO COMPRENDE I RICAMBI EVIDENZIATI CON LO STESSO COLORE E LE RELATIVE GUARNIZIONI. QUESTI RICAMBI NON SONO FORNIBILI SEPARATAMENTE TRANNE QUELLI CODIFICATI.		
SPARE PARTS KITS		
EACH KIT SHOWN WITH THE SAME COLOR INCLUDES ALSO THE GASKETS. THE SPARE PARTS INCLUDED IN THE KIT CAN'T BE SUPPLIED SEPARATELY EXCEPT THOSE SHOWN WITH A PROPER CODE.		
CODICE CODE	DESCRIZIONE DESCRIPTION	Q.TÀ QTY
KR7701	KIT BOCCOLA SOSTEGNO TAMBUR BUSH DRUM SUPPORT KIT	1
KR7723	SET VITI AVVOLGITUBO SET OF SCREWS	1
KR7725	KIT MOTORE 230 V MOTOR KIT 230 V	1
KR7728	KIT RIDUTTORE A RINVIO (Z1.114) REFERENCE GEARBOX (Z1.114)	1
KR7729	KIT RIDUTTORE A RINVIO (Z2.14) REFERENCE GEARBOX (Z2.14)	1

ELENCO RICAMBI FORNIBILI SINGOLARMENTE		
LIST OF SPARE PARTS WHICH CAN BE SUPPLIED SEPARATELY		
CODICE CODE	DESCRIZIONE DESCRIPTION	Q.TÀ QTY
77/1F	BLOCCO TAMBUR (FRENO) DRUM LOCK	1
77/2F	FRENO FRIZIONE BRAKE CLUTCH	1
B1237	PIGNONE DENTATO MOTORE MOTOR PINION	1
E062	MOTORE 230 V MOTOR 230 V	1
G298/R7035	STAFFA SUPPORTO MOTORE MOTOR SUPPORT BRACKET	1
G340/R7035	CILINDRO TAMBUR (Art.7721601.100 - 400) BARREL DRUM (Art.7721601.100 - 400)	1
G341/R7035	TRAVERSO POSTERIORE (Art.7721601.100 - 400) BACK SUPPORT (Art.7721601.100 - 400)	1
G342/R7035	TRAVERSO ANTERIORE (Art.7721601.100 - 400) FRONT SUPPORT (Art.7721601.100 - 400)	1
G372/R7035	CILINDRO TAMBUR (Art.7771601.100 - 400) BARREL DRUM (Art.7771601.100 - 400)	1
G373/R7035	TRAVERSO POSTERIORE (Art.7771601.100 - 400) BACK SUPPORT (Art.7771601.100 - 400)	1
G374/R7035	TRAVERSO ANTERIORE (Art.7771601.100 - 400) FRONT SUPPORT (Art.7771601.100 - 400)	1
G376/R7035	TRAVERSO POSTERIORE (Art.7741601.100 - 400) BACK SUPPORT (Art.7741601.100 - 400)	1
G377/R7035	TRAVERSO ANTERIORE (Art.7741601.100 - 400) FRONT SUPPORT (Art.7741601.100 - 400)	1
G436/R7035	STAFFA DI SOLLEVAMENTO LIFTING BRACKET	2
G484/R7035	TRAVERSO POSTERIORE (Art.7751601.100 - 400) BACK SUPPORT (Art.7751601.100 - 400)	1
G485/R7035	TRAVERSO ANTERIORE (Art.7751601.100 - 400) FRONT SUPPORT (Art.7751601.100 - 400)	1
G486/R7035	CILINDRO TAMBUR (Art.7741601.100 - 400) BARREL DRUM (Art.7741601.100 - 400)	1
G487/R7035	CILINDRO TAMBUR (Art.7751601.100 - 400) BARREL DRUM (Art.7751601.100 - 400)	1
G509/R7035	PIASTRA CIECA BLANKING PLATE	1
G626/R7035	CARTER DI PROTEZIONE GUARD	1
KC702	PERNO CENTRALE (Art.7721601.100 - 400) CENTRAL PIVOT (Art. 7721601.100 - 400)	1
KC703	PERNO CENTRALE (Art.7771601.100 - 400) CENTRAL PIVOT (Art. 7771601.100 - 400)	1
KC717/R7035	CARTER TAMBUR DRUM COVER	2
KC750	PERNO CENTRALE (Art.7741601.100 - 400) CENTRAL PIVOT (Art. 7741601.100 - 400)	1
KC751	PERNO CENTRALE (Art.7751601.100 - 400) CENTRAL PIVOT (Art. 7751601.100 - 400)	1
KC762/R7035	GUIDATUBO ARROTOLATORE HOSE GUIDE	1
KC810/R7035	STAFFA SOSTEGNO LATO MOTORE BRACKET ON THE MOTOR SIDE	1
KG817	SUPPORTO CON CUSCINETTO SUPPORT BEARING	1
KG818/R7035	STAFFA SOSTEGNO LATO BLOCCO BRACKET SIDE BLOCK	1
KG290	CATENA MOTORE RINVIO CHAIN REFERRAL MOTOR	1
KG291	CATENA RINVIO TAMBUR REFERRAL CHAIN DRUM	1
KG326	SNODO ARIA-ACQUA - 20 bar JOINT AIR-WATER 20 bar	1
KG330	SNODO OLIO-AFFINI - 70 bar JOINT OIL AND SIMILAR - 70 bar	1

ELENCO GUARNIZIONI SNODI		
JOINTS GASKETS LIST		
CODICE CODE	DESCRIZIONE DESCRIPTION	Q.TÀ QTY
H226	O-RING 155 "VITON" O-RING 155 "VITON"	1
H572	ANELLO ANTIESTRUSIONE BACKUP RING	1
H573	O-RING 3218 "VITON" O-RING 3218 "VITON"	1



Art. 7721801.100 Mod.772-IDR-20bar - Art. 7721801.400 Mod.772-IDR-70bar
 Art. 7741801.100 Mod.774-IDR-20bar - Art. 7741801.400 Mod.774-IDR-70bar
 Art. 7751801.100 Mod.775-IDR-20bar - Art. 7751801.400 Mod.775-IDR-70bar
 Art. 7771801.100 Mod.777-IDR-20bar - Art. 7771801.400 Mod.777-IDR-70bar



VISTA ESPLOSA - EXPLODED VIEW

N.b. Gli avvolgitubo idraulici S.700 oltre ad essere disponibili in 4 larghezze diverse (vedi note sotto riportate) possono montare 6 bocchette guidatubo differenti per tipo e posizione di montaggio (vedi esploso ricambi specifico bocchette guidatubo)

The S.700 hydraulic hose reels to be over available in 4 different widths (see note below) may fit different hose guide 6 ports by type and location of assembly (see specific spare parts jets hose guide)



AVVOLGITUBO S.700 IDRAULICO
 HYDRAULIC HOSE REELS S.700

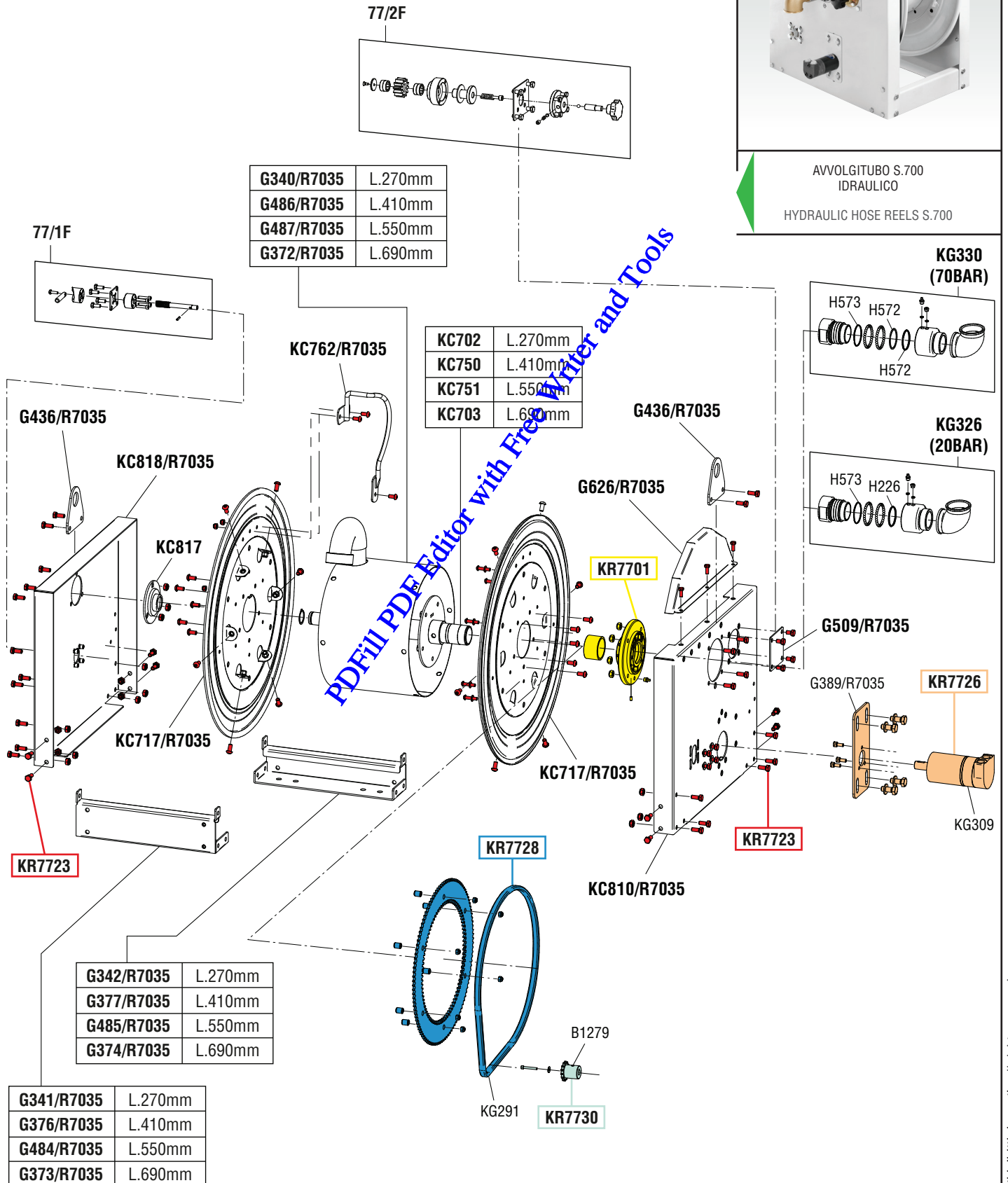

tutti i diritti riservati - all rights reserved



GUIDA RICAMBI - SPARE PARTS GUIDE

KIT RICAMBI		
OGNI KIT SOTTO RIPORTATO COMPRENDE I RICAMBI EVIDENZIATI CON LO STESSO COLORE E LE RELATIVE GUARNIZIONI. QUESTI RICAMBI NON SONO FORNIBILI SEPARATAMENTE TRANNE QUELLI CODIFICATI.		
SPARE PARTS KITS		
EACH KIT SHOWN WITH THE SAME COLOR INCLUDES ALSO THE GASKETS. THE SPARE PARTS INCLUDED IN THE KIT CAN'T BE SUPPLIED SEPARATELY EXCEPT THOSE SHOWN WITH A PROPER CODE.		
CODICE CODE	DESCRIZIONE DESCRIPTION	Q.TÀ QTY
KR7701	KIT BOCCOLA SOSTEGNO TAMBUR BUSH DRUM SUPPORT KIT	1
KR7723	SET VITI AVVOLGITUBO SET OF SCREWS	1
KR7726	KIT MOTORE IDRAULICO HYDRAULIC MOTOR KIT	1
KR7728	KIT RIDUTTORE A RINVIO (Z1.114) REFERENCE GEARBOX (Z1.114)	1
KR7730	PIGNONE DENTATO (Z2.14) PINION (Z2.14)	1

ELENCO RICAMBI FORNIBILI SINGOLARMENTE		
LIST OF SPARE PARTS WHICH CAN BE SUPPLIED SEPARATELY		
CODICE CODE	DESCRIZIONE DESCRIPTION	Q.TÀ QTY
77/1F	BLOCCO TAMBUR (FRENO) DRUM LOCK	1
77/2F	FRENO FRIZIONE BRAKE CLUTCH	1
B1279	PIGNONE DENTATO MOTORE MOTOR PINION	1
G340/R7035	CILINDRO TAMBUR (Art.7721801.100 - .400) BARREL DRUM (Art.7721801.100 - .400)	1
G341/R7035	TRAVERSO POSTERIORE (Art.7721801.100 - .400) BACK SUPPORT (Art.7721801.100 - .400)	1
G342/R7035	TRAVERSO ANTERIORE (Art.7721801.100 - .400) FRONT SUPPORT (Art.7721801.100 - .400)	1
G372/R7035	CILINDRO TAMBUR (Art.7771801.100 - .400) BARREL DRUM (Art.7771801.100 - .400)	1
G373/R7035	TRAVERSO POSTERIORE (Art.7771801.100 - .400) BACK SUPPORT (Art.7771801.100 - .400)	1
G374/R7035	TRAVERSO ANTERIORE (Art.7771801.100 - .400) FRONT SUPPORT (Art.7771801.100 - .400)	1
G376/R7035	TRAVERSO POSTERIORE (Art.7741801.100 - .400) BACK SUPPORT (Art.7741801.100 - .400)	1
G377/R7035	TRAVERSO ANTERIORE (Art.7741801.100 - .400) FRONT SUPPORT (Art.7741801.100 - .400)	1
G389/R7035	STAFFA SUPPORTO MOTORE MOTOR SUPPORT BRACKET	1
G436/R7035	STAFFA DI SOLLEVAMENTO LIFTING BRACKET	1
G484/R7035	TRAVERSO POSTERIORE (Art.7751801.100 - .400) BACK SUPPORT (Art.7751801.100 - .400)	1
G485/R7035	TRAVERSO ANTERIORE (Art.7751801.100 - .400) FRONT SUPPORT (Art.7751801.100 - .400)	1
G486/R7035	CILINDRO TAMBUR (Art.7741801.100 - .400) BARREL DRUM (Art.7741801.100 - .400)	1
G487/R7035	CILINDRO TAMBUR (Art.7751801.100 - .400) BARREL DRUM (Art.7751801.100 - .400)	1
G509/R7035	PIASTRA CIECA BLANKING PLATE	1
G626/R7035	CARTER DI PROTEZIONE GUARD	1
KC702	PERNO CENTRALE (Art.7721801.100 - .400) CENTRAL PIVOT (Art.7721801.100 - .400)	1
KC703	PERNO CENTRALE (Art.7771801.100 - .400) CENTRAL PIVOT (Art.7771801.100 - .400)	1
KC717/R7035	CARTER TAMBUR DRUM COVER	2
KC750	PERNO CENTRALE (Art.7741801.100 - .400) CENTRAL PIVOT (Art.7741801.100 - .400)	1
KC751	PERNO CENTRALE (Art.7751801.100 - .400) CENTRAL PIVOT (Art.7751801.100 - .400)	1
KC762/R7035	GUIDATUBO ARROTOLATORE HOSE GUIDE	1
KC810/R7035	STAFFA SOSTEGNO LATO MOTORE BRACKET ON THE MOTOR SIDE	1
KC817	SUPPORTO CON CUSCINETTO SUPPORT BEARING	1
KC818/R7035	STAFFA SOSTEGNO LATO BLOCCO BRACKET SIDE BLOCK	1
KG291	CATENA RINVIO TAMBUR REFERRAL CHAIN DRUM	1
KG309	MOTORE IDRAULICO HYDRAULIC MOTOR	1
KG326	SNODO ARIA-ACQUA - 20 bar JOINT AIR-WATER 20 bar	1
KG330	SNODO OLIO-AFFINI - 70 bar JOINT OIL AND SIMILAR - 70 bar	1

ELENCO GUARNIZIONI SNODI		
JOINTS GASKETS LIST		
CODICE CODE	DESCRIZIONE DESCRIPTION	Q.TÀ QTY
H226	O-RING 155 "VITON" O-RING 155 "VITON"	1
H572	ANELLO ANTIESTRUSIONE BACKUP RING	1
H573	O-RING 3218 "VITON" O-RING 3218 "VITON"	1



Art. 7721901.100 Mod.772-PNE-20bar - Art. 7721901.400 Mod.772-PNE-70bar
 Art. 7741901.100 Mod.774-PNE-20bar - Art. 7741901.400 Mod.774-PNE-70bar
 Art. 7751901.100 Mod.775-PNE-20bar - Art. 7751901.400 Mod.775-PNE-70bar
 Art. 7771901.100 Mod.777-PNE-20bar - Art. 7771901.400 Mod.777-PNE-70bar



VISTA ESPLOSA - EXPLODED VIEW

N.b. Gli avvolgitubo pneumatici S.700 oltre ad essere disponibili in 4 larghezze diverse (vedi note sotto riportate) possono montare 6 bocchette guidatubo differenti per tipo e posizione di montaggio (vedi esploso ricambi specifico bocchette guidatubo)

The S.700 pneumatic hose reels to be over available in 4 different widths (see note below) may fit different hose guide 6 ports by type and location of assembly (see specific spare parts jets hose guide)



AVVOLGITUBO S.700 PNEUMATICO
 PNEUMATIC HOSE REELS S.700

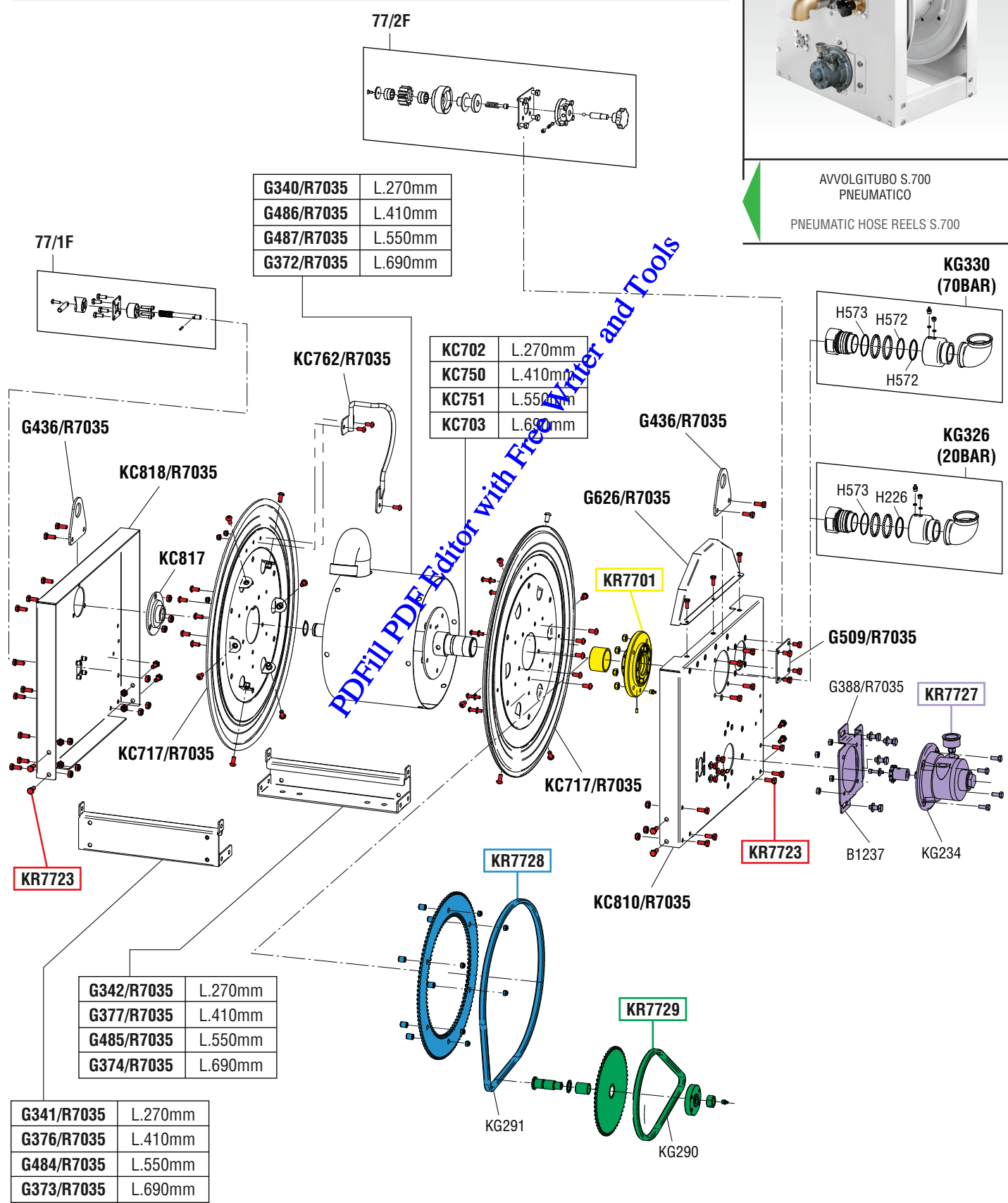

tutti i diritti riservati - all rights reserved

GUIDA RICAMBI - SPARE PARTS GUIDE

KIT RICAMBI		
OGNI KIT SOTTO RIPORTATO COMPRENDE I RICAMBI EVIDENZIATI CON LO STESSO COLORE E LE RELATIVE GUARNIZIONI. QUESTI RICAMBI NON SONO FORNIBILI SEPARATAMENTE TRANNE QUELLI CODIFICATI.		
SPARE PARTS KITS		
EACH KIT SHOWN WITH THE SAME COLOR INCLUDES ALSO THE GASKETS. THE SPARE PARTS INCLUDED IN THE KIT CAN'T BE SUPPLIED SEPARATELY EXCEPT THOSE SHOWN WITH A PROPER CODE.		
CODICE CODE	DESCRIZIONE DESCRIPTION	Q.TÀ QTY
KR7701	KIT BOCCOLA SOSTEGNO TAMBUR BUSH DRUM SUPPORT KIT	1
KR7723	SET VITI AVVOLGITUBO SET OF SCREWS	1
KR7727	KIT MOTORE PNEUMATICO PNEUMATIC MOTOR KIT	1
KR7728	KIT RIDUTTORE A RINVIO (Z1.114) REFERENCE GEARBOX (Z1.114)	1
KR7729	KIT RIDUTTORE A RINVIO (Z2.14) REFERENCE GEARBOX (Z2.14)	1

ELENCO RICAMBI FORNIBILI SINGOLARMENTE		
LIST OF SPARE PARTS WHICH CAN BE SUPPLIED SEPARATELY		
CODICE CODE	DESCRIZIONE DESCRIPTION	Q.TÀ QTY
77/1F	BLOCCO TAMBUR (FRENO) DRUM LOCK	1
77/2F	FRENO FRIZIONE BRAKE CLUTCH	1
B1237	PIGNONE DENTATO MOTORE MOTOR PINION	1
G340/R7035	CILINDRO TAMBUR (Art.7721901.100 - .400) BARREL DRUM (Art.7721901.100 - .400)	1
G341/R7035	TRAVERSO POSTERIORE (Art.7721901.100 - .400) BACK SUPPORT (Art.7721901.100 - .400)	1
G342/R7035	TRAVERSO ANTERIORE (Art.7721901.100 - .400) FRONT SUPPORT (Art.7721901.100 - .400)	1
G372/R7035	CILINDRO TAMBUR (Art.7771901.100 - .400) BARREL DRUM (Art.7771901.100 - .400)	1
G373/R7035	TRAVERSO POSTERIORE (Art.7771901.100 - .400) BACK SUPPORT (Art.7771901.100 - .400)	1
G374/R7035	TRAVERSO ANTERIORE (Art.7771901.100 - .400) FRONT SUPPORT (Art.7771901.100 - .400)	1
G376/R7035	TRAVERSO POSTERIORE (Art.7741901.100 - .400) BACK SUPPORT (Art.7741901.100 - .400)	1
G377/R7035	TRAVERSO ANTERIORE (Art.7741901.100 - .400) FRONT SUPPORT (Art.7741901.100 - .400)	1
G388/R7035	STAFFA SUPPORTO MOTORE MOTOR SUPPORT BRACKET	1
G436/R7035	STAFFA DI SOLLEVAMENTO LIFTING BRACKET	1
G484/R7035	TRAVERSO POSTERIORE (Art.7751901.100 - .400) BACK SUPPORT (Art.7751901.100 - .400)	1
G485/R7035	TRAVERSO ANTERIORE (Art.7751901.100 - .400) FRONT SUPPORT (Art.7751901.100 - .400)	1
G486/R7035	CILINDRO TAMBUR (Art.7741901.100 - .400) BARREL DRUM (Art.7741901.100 - .400)	1
G487/R7035	CILINDRO TAMBUR (Art.7751901.100 - .400) BARREL DRUM (Art.7751901.100 - .400)	1
G509/R7035	PIASTRA CIECA BLANKING PLATE	1
G626/R7035	CARTER DI PROTEZIONE GUARD	1
KC702	PERNO CENTRALE (Art.7721901.100 - .400) CENTRAL PIVOT (Art.7721901.100 - .400)	1
KC703	PERNO CENTRALE (Art.7771901.100 - .400) CENTRAL PIVOT (Art.7771901.100 - .400)	1
KC717/R7035	CARTER TAMBUR DRUM COVER	2
KC750	PERNO CENTRALE (Art.7741901.100 - .400) CENTRAL PIVOT (Art.7741901.100 - .400)	1
KC751	PERNO CENTRALE (Art.7751901.100 - .400) CENTRAL PIVOT (Art.7751901.100 - .400)	1
KC762/R7035	GUIDATUBO ARROTOLATORE HOSE GUIDE	1
KC810/R7035	STAFFA SOSTEGNO LATO MOTORE BRACKET ON THE MOTOR SIDE	1
KC817	SUPPORTO CON CUSCINETTO SUPPORT BEARING	1
KC818/R7035	STAFFA SOSTEGNO LATO BLOCCO BRACKET SIDE BLOCK	1
KG234	MOTORE PNEUMATICO PNEUMATIC MOTOR	1
KG290	CATENA MOTORE RINVIO CHAIN REFERRAL MOTOR	1
KG291	CATENA RINVIO TAMBUR REFERRAL CHAIN DRUM	1
KG326	SNODO ARIA-ACQUA - 20 bar JOINT AIR-WATER 20 bar	1
KG330	SNODO OLIO-AFFINI - 70 bar JOINT OIL AND SIMILAR - 70 bar	1





ELENCO GUARNIZIONI SNODI		
JOINTS GASKETS LIST		
CODICE CODE	DESCRIZIONE DESCRIPTION	Q.TÀ QTY
H226	O-RING 155 "VITON" O-RING 155 "VITON"	1
H572	ANELLO ANTIESTRUSIONE BACKUP RING	1
H573	O-RING 3218 "VITON" O-RING 3218 "VITON"	1



BOCCHETTE GUIDA TUBO per avvolgitubo manuali S.700
 HOSE GUIDE for S.700 manual hose reels

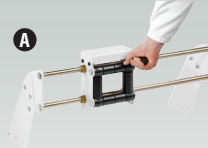
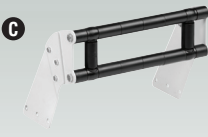
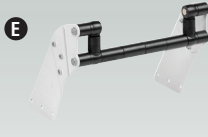

VISTA ESPLOSA - EXPLODED VIEW

<p>A</p>  <p>Art.77/22775B Art.77/24175B Art.77/25575B Art.77/26975B</p>	<p>C</p>  <p>Art.77/12775B Art.77/14175B Art.77/15575B Art.77/16975B</p>	<p>E</p>  <p>Art.77/32775B Art.77/34175B Art.77/35575B Art.77/36975B</p>	<p>BOCCHETTE GUIDA TUBO AVVOLGITUBO MANUALE S.700</p> <p>HOSE GUIDE FOR S.700 MANUAL HOSE REEL</p>
<p>B</p>  <p>Art.77/22775 Art.77/24175 Art.77/25575 Art.77/26975</p>	<p>D</p>  <p>Art.77/12775 Art.77/14175 Art.77/15575 Art.77/16975</p>	<p>F</p>  <p>Art.77/32775 Art.77/34175 Art.77/35575 Art.77/36975</p>	

A

B1109	L.270mm
B1166	L.410mm
B1350	L.550mm
B1165	L.690mm

B

B1109	L.270mm
B1166	L.410mm
B1350	L.550mm
B1165	L.690mm

C

KR7710	L.270mm
KR7711	L.410mm
KR7712	L.550mm
KR7713	L.690mm

KR7710	L.270mm
KR7711	L.410mm
KR7712	L.550mm
KR7713	L.690mm

E

KR7714	L.270mm
KR7715	L.410mm
KR7716	L.550mm
KR7717	L.690mm

KR7714	L.270mm
KR7715	L.410mm
KR7716	L.550mm
KR7717	L.690mm

tutti i diritti riservati - all rights reserved



GUIDA RICAMBI - SPARE PARTS GUIDE

KIT RICAMBI

OGNI KIT SOTTO RIPORTATO COMPRENDE I RICAMBI EVIDENZIATI CON LO STESSO COLORE E LE RELATIVE GUARNIZIONI. QUESTI RICAMBI NON SONO FORNIBILI SEPARATAMENTE TRANNE QUELLI CODIFICATI.

SPARE PARTS KITS

EACH KIT SHOWN WITH THE SAME COLOR INCLUDES ALSO THE GASKETS. THE SPARE PARTS INCLUDED IN THE KIT CAN'T BE SUPPLIED SEPARATELY EXCEPT THOSE SHOWN WITH A PROPER CODE.

CODICE CODE	DESCRIZIONE DESCRIPTION	PER ARTICOLO FOR P/N	Q.TÀ QTY
KR7709	KIT PORTA RULLI ROLLERS HOLDING KIT	77/22775B - 77/24175B - 77/25575B - 77/26975B 77/22775 - 77/24175 - 77/25575 - 77/26975	1
KR7710	KIT PORTA RULLI ROLLERS HOLDING KIT	77/12775B - 77/12775 (L.270 mm)	1
KR7711	KIT PORTA RULLI ROLLERS HOLDING KIT	77/14175B - 77/14175 (L.410 mm)	1
KR7712	KIT PORTA RULLI ROLLERS HOLDING KIT	77/15575B - 77/15575 (L.550 mm)	1
KR7713	KIT PORTA RULLI ROLLERS HOLDING KIT	77/16975B - 77/16975 (L.690 mm)	1
KR7714	KIT PORTA RULLI ROLLERS HOLDING KIT	77/32775B - 77/32775 (L.270 mm)	1
KR7715	KIT PORTA RULLI ROLLERS HOLDING KIT	77/34175B - 77/34175 (L.410 mm)	1
KR7716	KIT PORTA RULLI ROLLERS HOLDING KIT	77/35575B - 77/35575 (L.550 mm)	1
KR7717	KIT PORTA RULLI ROLLERS HOLDING KIT	77/66975B - 77/36975 (L.690 mm)	1
KR7718	KIT BOCCOLA SCORRIMENTO GUIDA TUBO BUSHING KIT SLIDING GUIDE TUBE	77/22775B - 77/24175B - 77/25575B - 77/26975B 77/22775 - 77/24175 - 77/25575 - 77/26975	1
KR7719	SET VITI BOCCHETTA SET OF SCREWS FOR NOZZLE	77/22775B - 77/24175B - 77/25575B - 77/26975B	1
KR7720	SET VITI BOCCHETTA SET OF SCREWS FOR NOZZLE	77/22775 - 77/24175 - 77/25575 - 77/26975	1
KR7721	SET VITI BOCCHETTA SET OF SCREWS FOR NOZZLE	77/12775B - 77/14175B - 77/15575B - 77/16975B 77/32775B - 77/34175B - 77/35575B - 77/36975B	1
KR7722	SET VITI BOCCHETTA SET OF SCREWS FOR NOZZLE	77/12775 - 77/14175 - 77/15575 - 77/16975 77/32775 - 77/34175 - 77/35575 - 77/36975	1

ELENCO RICAMBI FORNIBILI SINGOLARMENTE

LIST OF SPARE PARTS WHICH CAN BE SUPPLIED SEPARATELY

CODICE CODE	DESCRIZIONE DESCRIPTION	Q.TÀ QTY
B1109	PERNO ORIZZONTALE - L.270 mm HORIZONTAL PIN - L.270 mm	2
B1165	PERNO ORIZZONTALE - L.410 mm HORIZONTAL PIN - L.410 mm	2
B1166	PERNO ORIZZONTALE - L.550 mm HORIZONTAL PIN - L.550 mm	2
B1350	PERNO ORIZZONTALE - L.690 mm HORIZONTAL PIN - L.690 mm	2
G268/R7035	STAFFA BOCCHETTA RULLI NOZZLE ROLLER BRACKET	2
G519/R7035	STAFFA BOCCHETTA GUIDA MANUALE MANUAL STEERING NOZZLE BRACKET	2
G573/R7035	SUPPORTO VOLANTINO GUIDA MANUALE MANUAL STEERING WHEEL SUPPORT	1
G596/R7035	BRACCETTO DESTRO RIGHT ARM	1
G597/R7035	BRACCETTO SINISTRO LEFT ARM	1
M336	DADO M12 NUT M12	1
M812	IMPUGNATURA CILINDRICA M12 CYLINDRICAL HANDLE M12	1

PDFfill PDF Editor with Free Writer and Tools



Art. 80035



VISTA ESPLOSA - EXPLODED VIEW



CARRELLO PER FUSTI
DA 20 - 60 Kg
TROLLEY FOR DRUMS
20 - 60 Kg

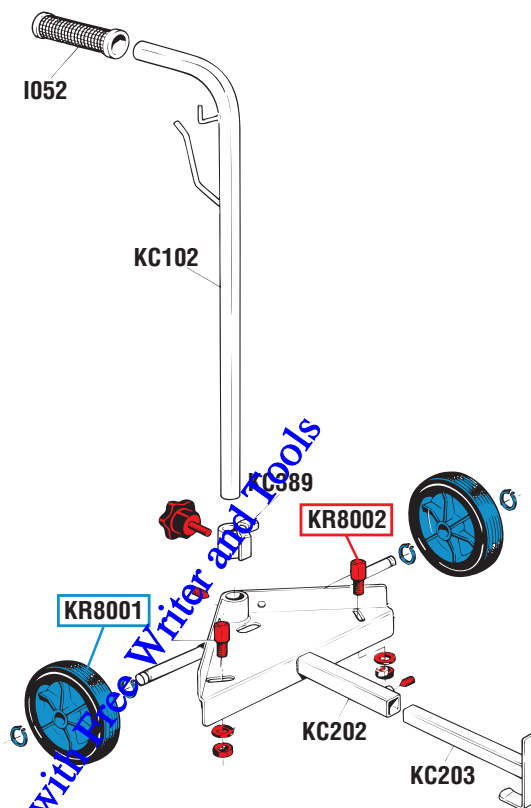

tutti i diritti riservati - all rights reserved

GUIDA RICAMBI - SPARE PARTS GUIDE

KIT RICAMBI
OGNI KIT SOTTO RIPORTATO COMPRENDE I RICAMBI EVIDENZIATI CON LO STESSO COLORE E LE RELATIVE GUARNIZIONI. QUESTI RICAMBI NON SONO FORNIBILI SEPARATAMENTE TRAMIE QUELLI CODIFICATI.

SPARE PARTS KITS
EACH KIT SHOWN WITH THE SAME COLOR INCLUDES ALSO THE GASKETS. THE SPARE PARTS INCLUDED IN THE KIT CAN'T BE SUPPLIED SEPARATELY EXCEPT THOSE SHOWN WITH A PROPER CODE.

CODICE CODE	DESCRIZIONE DESCRIPTION	Q.TÀ QTY
KR8001	2 RUOTE FISSE ø 125 mm 2 FIXED WHEELS ø 125 mm	1
KR8002	ACCESSORI ACCESSORIES	1

ELENCO RICAMBI FORNIBILI SINGOLARMENTE
LIST OF SPARE PARTS WHICH CAN BE SUPPLIED SEPARATELY

CODICE CODE	DESCRIZIONE DESCRIPTION	Q.TÀ QTY
1052	MANOPOLA KNOB	1
KC389	GANCIO BLOCCA FUSTO DRUM HOLDING HOOK	1
KC102	MANICO HANDLE	1
KC202	PIANO CARRELLO TROLLEY TOP	1
KC203	SUPPORTO REGOLABILE ADJUSTABLE SUPPORT	1



Art. 80040



VISTA ESPLOSA - EXPLODED VIEW



CARRELLO PER FUSTI
DA 20 - 60 Kg
TROLLEY FOR DRUMS
20 - 60 Kg

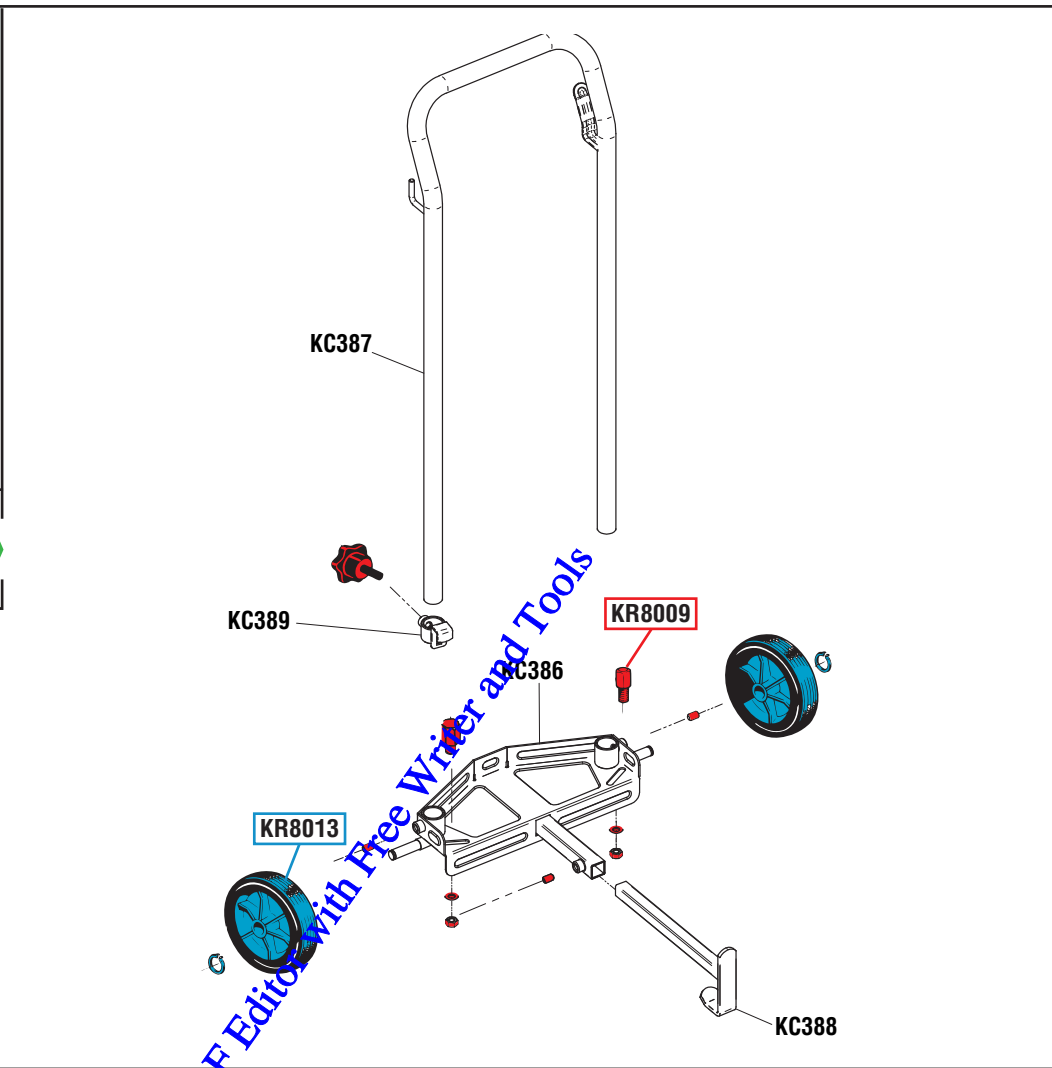

tutti i diritti riservati - all rights reserved

GUIDA RICAMBI - SPARE PARTS GUIDE

KIT RICAMBI
OGNI KIT SOTTO RIPORTATO COMPRENDE I RICAMBI EVIDENZIATI CON LO STESSO COLORE E LE RELATIVE GUARNIZIONI. QUESTI RICAMBI NON SONO FORNIBILI SEPARATAMENTE TRAMIE QUELLI CODIFICATI.

SPARE PARTS KITS
EACH KIT SHOWN WITH THE SAME COLOR INCLUDES ALSO THE GASKETS. THE SPARE PARTS INCLUDED IN THE KIT CAN'T BE SUPPLIED SEPARATELY EXCEPT THOSE SHOWN WITH A PROPER CODE.

CODICE CODE	DESCRIZIONE DESCRIPTION	Q.TÀ QTY
KR8009	ACCESSORI ACCESSORIES	1
KR8013	2 RUOTE FISSE ø 150 mm 2 FIXED WHEELS ø 150 mm	1

ELENCO RICAMBI FORNIBILI SINGOLARMENTE
LIST OF SPARE PARTS WHICH CAN BE SUPPLIED SEPARATELY

CODICE CODE	DESCRIZIONE DESCRIPTION	Q.TÀ QTY
KC386	PIANO CARRELLO TROLLEY TOP	1
KC387	MANICO HANDLE	1
KC388	SUPPORTO REGOLABILE ADJUSTABLE SUPPORT	1
KC389	GANCIO BLOCCA FUSTO DRUM HOLDING HOOK	1



Art. 80050



VISTA ESPLOSA - EXPLODED VIEW

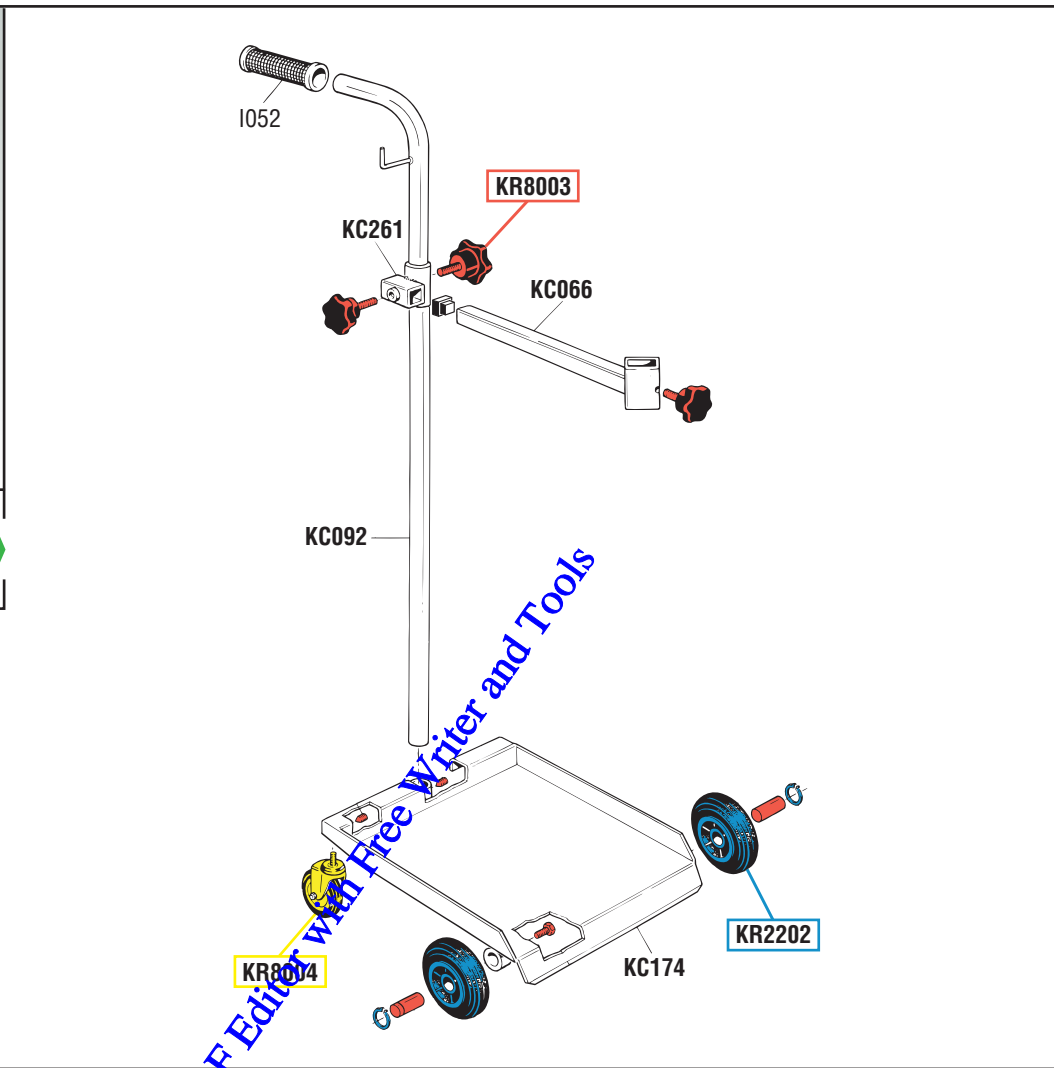

tutti i diritti riservati - all rights reserved

GUIDA RICAMBI - SPARE PARTS GUIDE

KIT RICAMBI
OGNI KIT SOTTO RIPORTATO COMPRENDE I RICAMBI EVIDENZIATI CON LO STESSO COLORE E LE RELATIVE GUARNIZIONI. QUESTI RICAMBI NON SONO FORNIBILI SEPARATAMENTE TRAMIE QUELLI CODIFICATI.

SPARE PARTS KITS
EACH KIT SHOWN WITH THE SAME COLOR INCLUDES ALSO THE GASKETS. THE SPARE PARTS INCLUDED IN THE KIT CAN'T BE SUPPLIED SEPARATELY EXCEPT THOSE SHOWN WITH A PROPER CODE.

CODICE CODE	DESCRIZIONE DESCRIPTION	Q.TÀ QTY
KR2202	DUE RUOTE FISSE CON ANELLI ELASTICI TWO FIXED WHEELS WITH RETAINING RINGS	1
KR8003	ACCESSORI ACCESSORIES	1
KR8004	2 RUOTE PIROETTANTI ø 60 mm 2 SWIVELING WHEELS ø 60 mm	1

ELENCO RICAMBI FORNIBILI SINGOLARMENTE
LIST OF SPARE PARTS WHICH CAN BE SUPPLIED SEPARATELY

CODICE CODE	DESCRIZIONE DESCRIPTION	Q.TÀ QTY
I052	MANOPOLA KNOB	1
KC066	STAFFA SUPPORTO ACCESSORI ACCESSORIES SUPPORT BRACKET	1
KC092	MANICO HANDLE	1
KC174	PIANO CARRELLO TROLLEY TOP	1
KC261	SUPPORTO REGOLABILE ADJUSTABLE SUPPORT	1



Art. 80200



VISTA ESPLOSA - EXPLODED VIEW

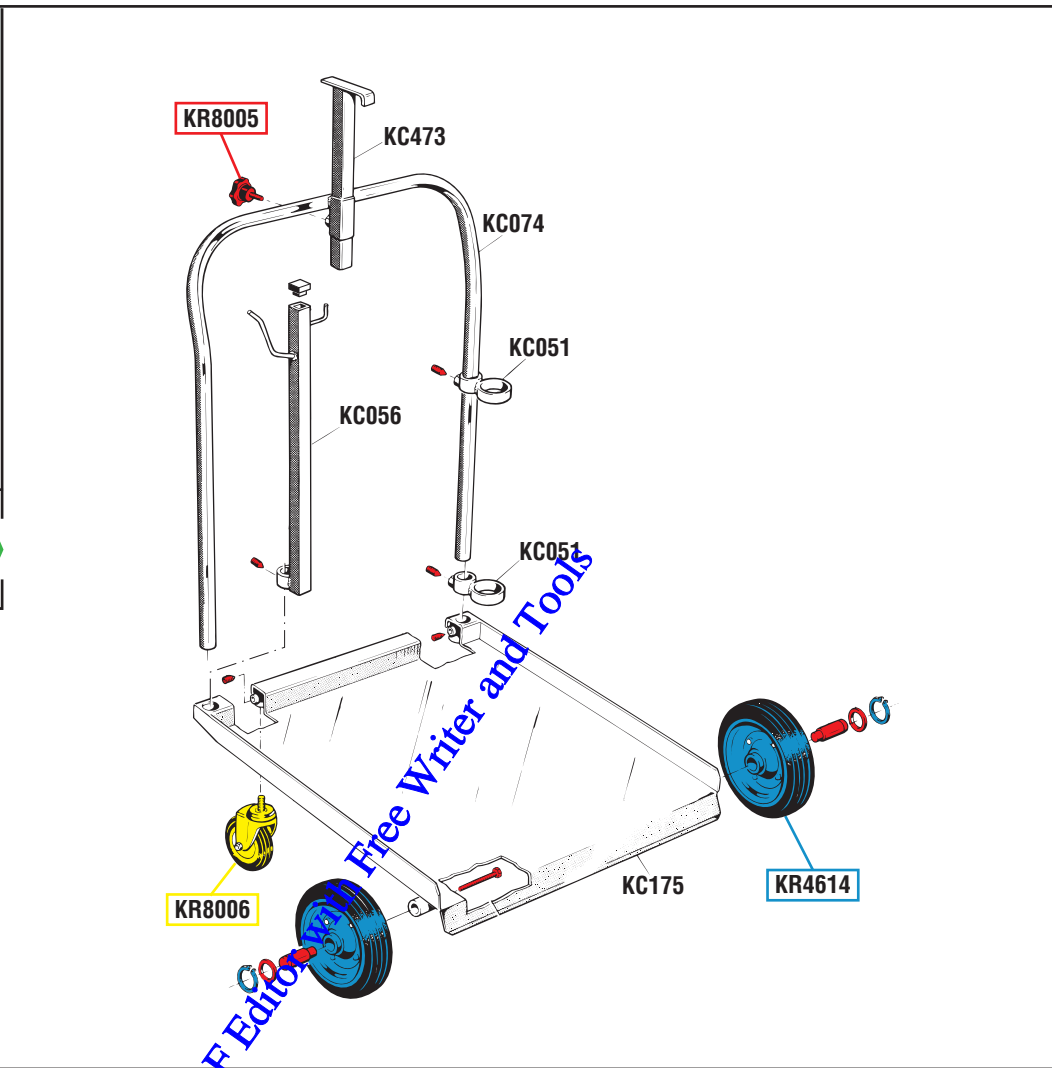

tutti i diritti riservati - all rights reserved

GUIDA RICAMBI - SPARE PARTS GUIDE

KIT RICAMBI
OGNI KIT SOTTO RIPORTATO COMPRENDE I RICAMBI EVIDENZIATI CON LO STESSO COLORE E LE RELATIVE GUARNIZIONI. QUESTI RICAMBI NON SONO FORNIBILI SEPARATAMENTE TRAMIE QUELLI CODIFICATI.

SPARE PARTS KITS
EACH KIT SHOWN WITH THE SAME COLOR INCLUDES ALSO THE GASKETS. THE SPARE PARTS INCLUDED IN THE KIT CAN'T BE SUPPLIED SEPARATELY EXCEPT THOSE SHOWN WITH A PROPER CODE.

CODICE CODE	DESCRIZIONE DESCRIPTION	Q.TÀ QTY
KR4614	2 RUOTE FISSI CON ANELLI ELASTICI 2 FIXED WHEELS WITH RETAINING RINGS	1
KR8005	ACCESSORI ACCESSORIES	1
KR8006	2 RUOTE PIROETTANTI ø 80 mm 2 SWIVELING WHEELS ø 80 mm	1

ELENCO RICAMBI FORNIBILI SINGOLARMENTE
LIST OF SPARE PARTS WHICH CAN BE SUPPLIED SEPARATELY

CODICE CODE	DESCRIZIONE DESCRIPTION	Q.TÀ QTY
KC051	SUPPORTO POMPA PUMP SUPPORT	2
KC056	SUPPORTO ACCESSORI ACCESSORIES SUPPORT	1
KC074	MANICO HANDLE	1
KC175	PIANO CARRELLO TROLLEY TOP	1
KC473	SUPPORTO BLOCCA FUSTO DRUM LOCK SUPPORT	1



Art. 80201



VISTA ESPLOSA - EXPLODED VIEW

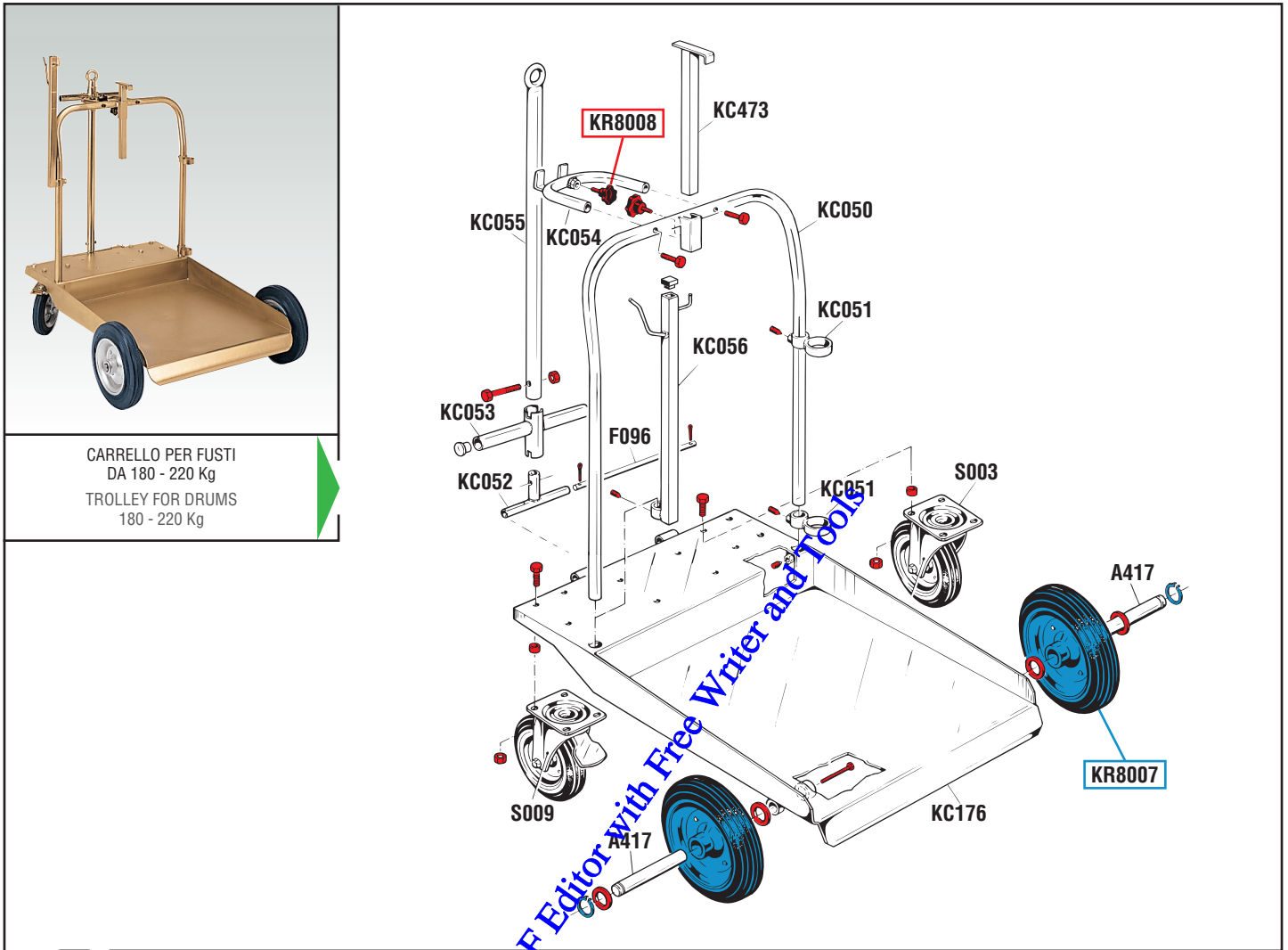

CARRELLO PER FUSTI
DA 180 - 220 Kg
TROLLEY FOR DRUMS
180 - 220 Kg

tutti i diritti riservati - all rights reserved

GUIDA RICAMBI - SPARE PARTS GUIDE

KIT RICAMBI

OGNI KIT SOTTO RIPORTATO COMPRENDE I RICAMBI EVIDENZIATI CON LO STESSO COLORE E LE RELATIVE GUARNIZIONI. QUESTI RICAMBI NON SONO FORNIBILI SEPARATAMENTE TRAMIE QUELLI CODIFICATI.

SPARE PARTS KITS

EACH KIT SHOWN WITH THE SAME COLOR INCLUDES ALSO THE GASKETS. THE SPARE PARTS INCLUDED IN THE KIT CAN'T BE SUPPLIED SEPARATELY EXCEPT THOSE SHOWN WITH A PROPER CODE.

CODICE CODE	DESCRIZIONE DESCRIPTION	Q.TÀ QTY
KR8007	2 RUOTE FISSE ø 280 mm 2 FIXED WHEELS ø 280 mm	1
KR8008	ACCESSORI ACCESSORIES	1

ELENCO RICAMBI FORNIBILI SINGOLARMENTE

LIST OF SPARE PARTS WHICH CAN BE SUPPLIED SEPARATELY

CODICE CODE	DESCRIZIONE DESCRIPTION	Q.TÀ QTY
A417	PERNO RUOTA WHEEL PIN	2
F096	SPINA SNODO JOINT PIN	1
KC050	MANICO FISSO FIXED HANDLE	1
KC051	SUPPORTO POMPA PUMP SUPPORT	2
KC052	SNODO MANICO HANDLE JOINT	1
KC053	IMPUGNATURA MANICO HANDLE GRIP	1
KC054	SUPPORTO MANICO HANDLE SUPPORT	1
KC055	MANICO MOBILE MOVABLE HANDLE	1
KC056	SUPPORTO ACCESSORI ACCESSORIES SUPPORT	1
KC176	PIANO CARRELLO TROLLEY TOP	1
KC473	SUPPORTO BLOCCA FUSTO DRUM LOCK SUPPORT	1
S003	RUOTA PIROETTANTE SWIVELLING WHEEL	1
S009	RUOTA PIROETTANTE CON FRENO SWIVELLING WHEEL WITH BRAKE	1



Art. 80210



VISTA ESPLOSA - EXPLODED VIEW

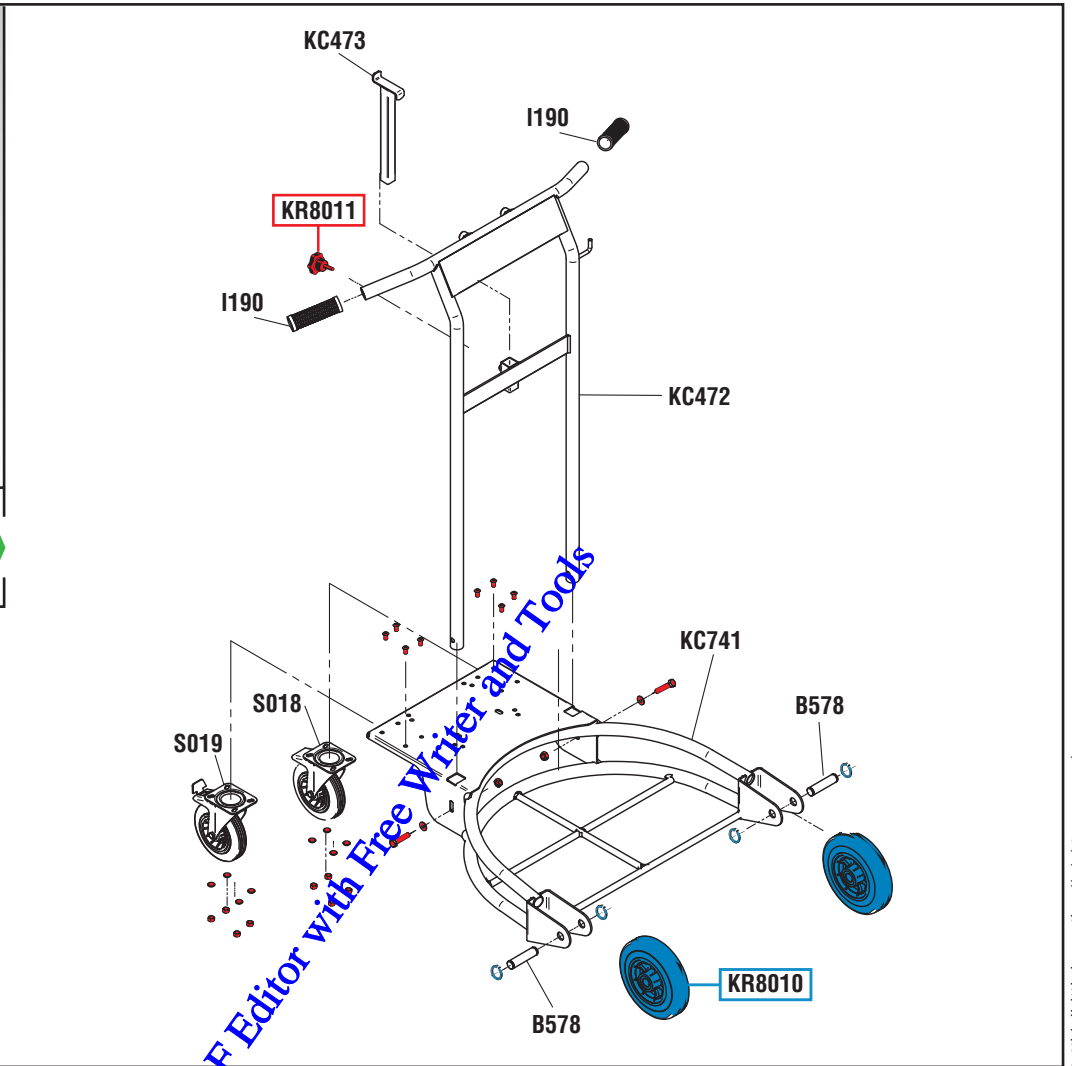

tutti i diritti riservati - all rights reserved

GUIDA RICAMBI - SPARE PARTS GUIDE

KIT RICAMBI
OGNI KIT SOTTO RIPORTATO COMPRENDE I RICAMBI EVIDENZIATI CON LO STESSO COLORE E LE RELATIVE GUARNIZIONI. QUESTI RICAMBI NON SONO FORNIBILI SEPARATAMENTE TRanne QUELLI CODIFICATI.

SPARE PARTS KITS
EACH KIT SHOWN WITH THE SAME COLOR INCLUDES ALSO THE GASKETS. THE SPARE PARTS INCLUDED IN THE KIT CAN'T BE SUPPLIED SEPARATELY EXCEPT THOSE SHOWN WITH A PROPER CODE.

CODICE CODE	DESCRIZIONE DESCRIPTION	Q.TÀ QTY
KR8010	2 RUOTE FISSE ø 200 mm 2 FIXED WHEELS ø 200 mm	1
KR8011	ACCESSORI ACCESSORIES	1

ELENCO RICAMBI FORNIBILI SINGOLARMENTE
LIST OF SPARE PARTS WHICH CAN BE SUPPLIED SEPARATELY

CODICE CODE	DESCRIZIONE DESCRIPTION	Q.TÀ QTY
B578	PERNO RUOTA WHEEL PIN	2
I190	MANOPOLA KNOB	2
KC472	MANICO PER CARRELLO TROLLEY HANDLE	1
KC473	SUPPORTO BLOCCA FUSTO DRUM LOCK SUPPORT	1
KC741	BASE CARRELLO TROLLEY BASE	1
S018	RUOTA PIROETTANTE SWIVELLING WHEEL	1
S019	RUOTA PIROETTANTE CON FRENO SWIVELLING WHEEL WITH BRAKE	1



Art. 80215



VISTA ESPLOSA - EXPLODED VIEW

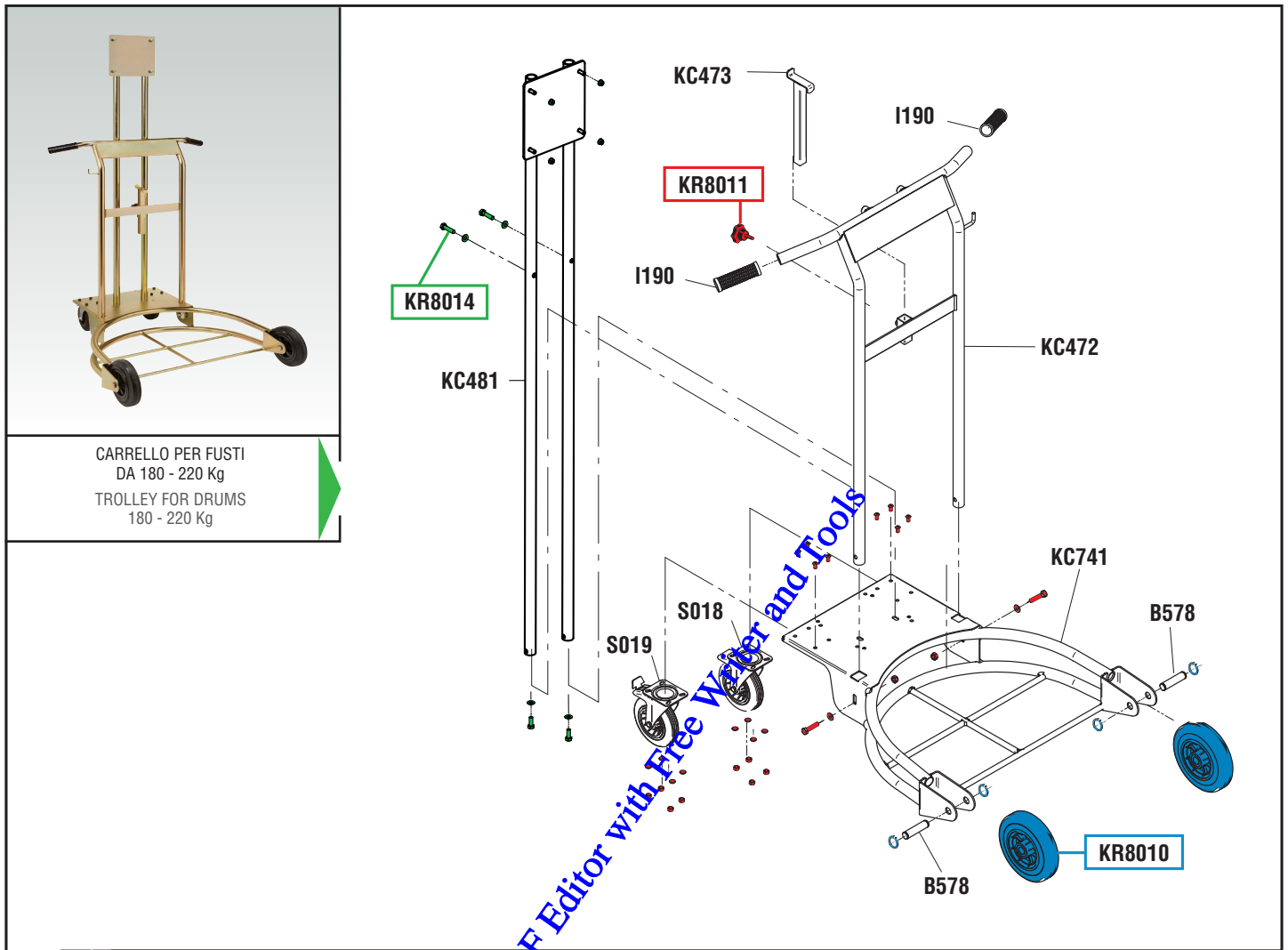

tutti i diritti riservati - all rights reserved

GUIDA RICAMBI - SPARE PARTS GUIDE

KIT RICAMBI

OGNI KIT SOTTO RIPORTATO COMPRENDE I RICAMBI EVIDENZIATI CON LO STESSO COLORE E LE RELATIVE GUARNIZIONI. QUESTI RICAMBI NON SONO FORNIBILI SEPARATAMENTE TRAMIE QUELLI CODIFICATI.

SPARE PARTS KITS

EACH KIT SHOWN WITH THE SAME COLOR INCLUDES ALSO THE GASKETS. THE SPARE PARTS INCLUDED IN THE KIT CAN'T BE SUPPLIED SEPARATELY EXCEPT THOSE SHOWN WITH A PROPER CODE.

CODICE CODE	DESCRIZIONE DESCRIPTION	Q.TÀ QTY
KR8010	2 RUOTE FISSE ø 200 mm 2 FIXED WHEELS ø 200 mm	1
KR8011	ACCESSORI ACCESSORIES	1
KR8014	SET VITI FISSAGGIO COLONNA PORTA ARROTOLATORE FIXING SCREWS	1

ELENCO RICAMBI FORNIBILI SINGOLARMENTE

LIST OF SPARE PARTS WHICH CAN BE SUPPLIED SEPARATELY

CODICE CODE	DESCRIZIONE DESCRIPTION	Q.TÀ QTY
B578	PERNO RUOTA WHEEL PIN	2
I190	MANOPOLA KNOB	2
KC472	MANICO PER CARRELLO TROLLEY HANDLE	1
KC473	SUPPORTO BLOCCA FUSTO DRUM LOCK SUPPORT	1
KC481	COLONNA PORTA ARROTOLATORE PER CARRELLO PORTA FUSTI HOSEREEL COLUMN FOR TROLLEY	
KC741	BASE CARRELLO TROLLEY BASE	1
S018	RUOTA PIROETTANTE SWIVELLING WHEEL	1
S019	RUOTA PIROETTANTE CON FRENO SWIVELLING WHEEL WITH BRAKE	1



tecnologia qualità & funzionalità
technology, quality, functionality

PDFill PDF Editor with Free Writer and Tools

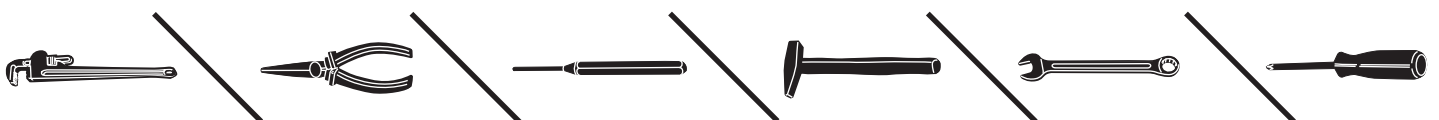



Art. 8288.100 Mod. 288-20 bar



VISTA ESPLOSA - EXPLODED VIEW

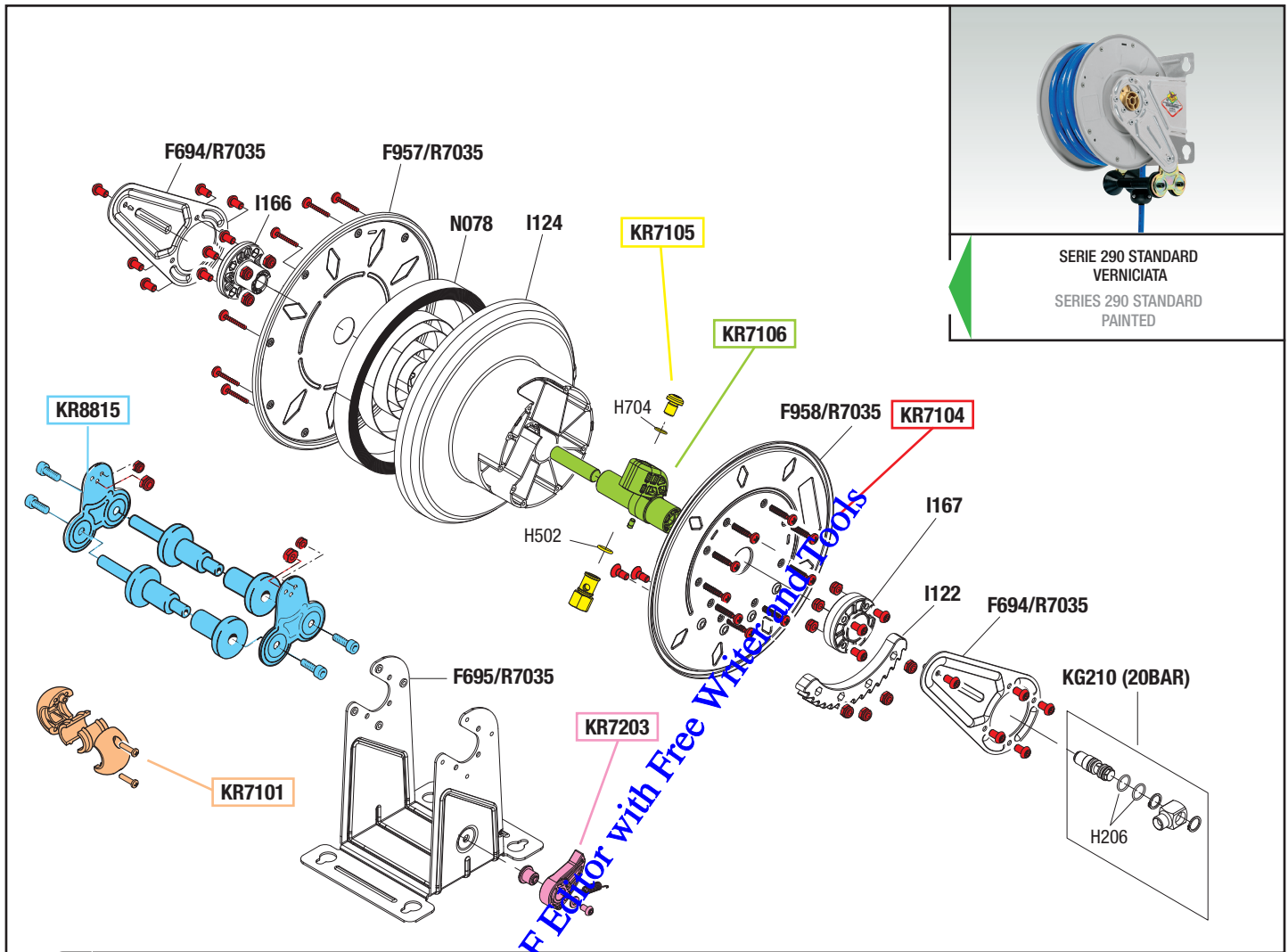

tutti i diritti riservati - all rights reserved

GUIDA RICAMBI - SPARE PARTS GUIDE

KIT RICAMBI

OGNI KIT SOTTO RIPORTATO COMPRENDE I RICAMBI EVIDENZIATI CON LO STESSO COLORE E LE RELATIVE GUARNIZIONI. QUESTI RICAMBI NON SONO FORNIBILI SEPARATAMENTE TRANNE QUELLI CODIFICATI.

SPARE PARTS KITS

EACH KIT SHOWN WITH THE SAME COLOR INCLUDES ALSO THE GASKETS. THE SPARE PARTS INCLUDED IN THE KIT CAN'T BE SUPPLIED SEPARATELY EXCEPT THOSE SHOWN WITH A PROPER CODE.

CODICE CODE	DESCRIZIONE DESCRIPTION	Q.TÀ QTY
KR7101	TAMPONE FERMATUBO HOSE STOP	1
KR7104	SET VITI AVVOLGITUBO SET OF SCREWS HOSEREEL	1
KR7105	BULLONE PER ATTACCO RAPIDO BOLT FOR QUICK CONNECTION	1
KR7106	PERNO CENTRALE CENTRAL PIVOT	1
KR7203	DENTE D'ARRESTO DETENT	1
KR8815	KIT PORTA RULLI ROLLERS HOLDING KIT	1

ELENCO RICAMBI FORNIBILI SINGOLARMENTE

LIST OF SPARE PARTS WHICH CAN BE SUPPLIED SEPARATELY

CODICE CODE	DESCRIZIONE DESCRIPTION	Q.TÀ QTY
F694/R7035	BRACCIO ORIENTABILE SWINGING ARM	2
F695/R7035	STAFFA BRACKET	1
F957/R7035	CARTER-MOLLA COVER-SPRING GROUP	1
F958/R7035	CARTER-LATO CREMAGLIERA COVER-SPRING GROUP	1
H502	O-RING 3056 "VITON" O-RING 3056 "VITON"	1
H704	O-RING 3037 "VITON" O-RING 3037 "VITON"	1
I122	CREMAGLIERA RACK	1
I124	TAMBURO 300/350 DRUM 300/350	1
I166	BOCCOLA LATO MOLLA BUSH	1
I167	BOCCOLA LATO CREMAGLIERA BUSH	1
KG210	SNODO DESTRO 20 BAR RIGHTJOINT 20 BAR	1
N078	MOLLA SPRING	1

ELENCO GUARNIZIONI SNODI

JOINTS GASKETS LIST

CODICE CODE	DESCRIZIONE DESCRIPTION	Q.TÀ QTY
H206	GUARNIZIONE OR 3043 VITON GASKET	2



Art. 8290.100 Mod. 290-20 bar



VISTA ESPLOSA - EXPLODED VIEW

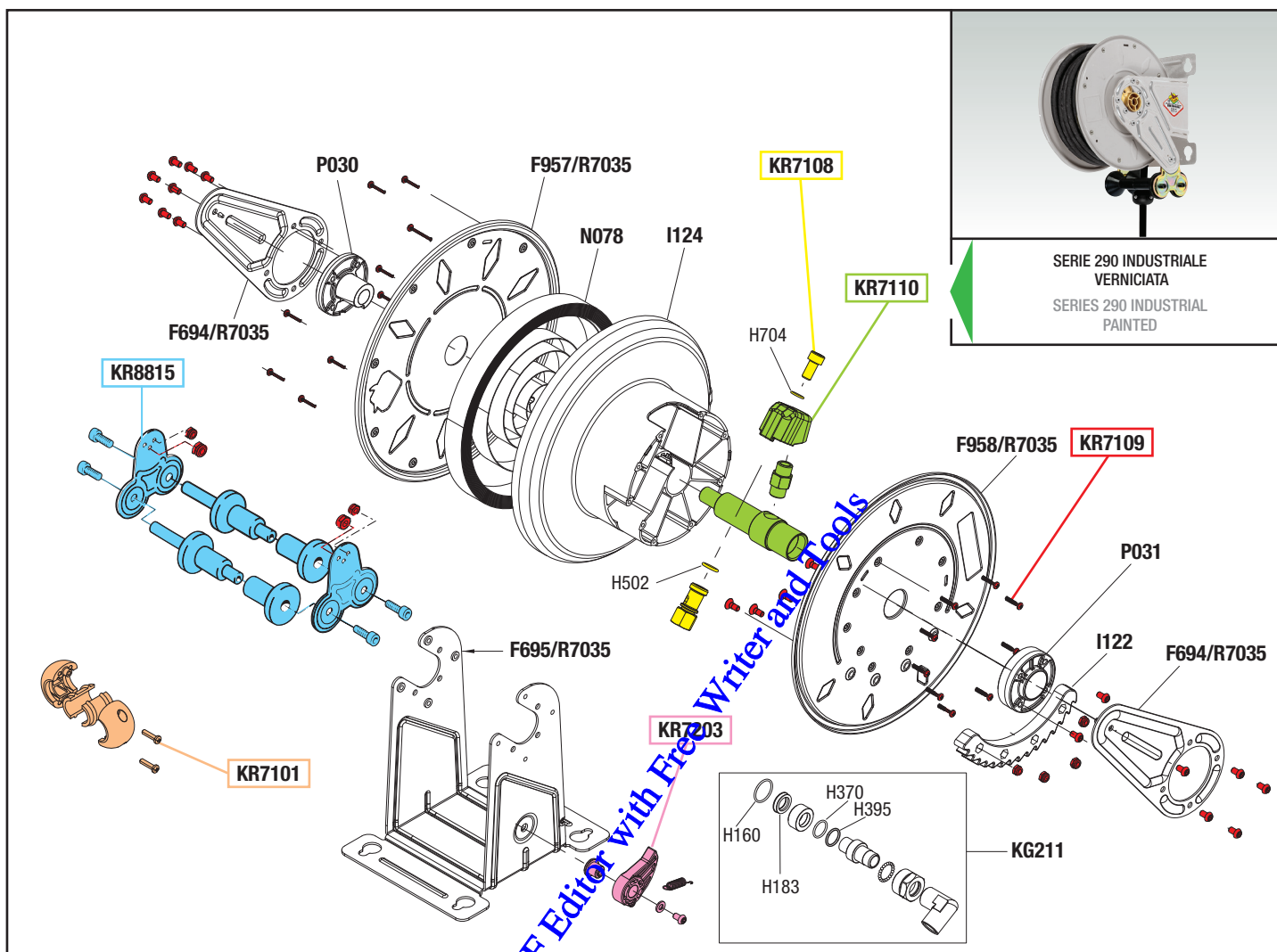

tutti i diritti riservati - all rights reserved

GUIDA RICAMBI - SPARE PARTS GUIDE

KIT RICAMBI

OGNI KIT SOTTO RIPORTATO COMPRENDE I RICAMBI EVIDENZIATI CON LO STESSO COLORE E LE RELATIVE GUARNIZIONI. QUESTI RICAMBI NON SONO FORNIBILI SEPARATAMENTE TRANNE QUELLI CODIFICATI.

SPARE PARTS KITS

EACH KIT SHOWN WITH THE SAME COLOR INCLUDES ALSO THE GASKETS. THE SPARE PARTS INCLUDED IN THE KIT CAN'T BE SUPPLIED SEPARATELY EXCEPT THOSE SHOWN WITH A PROPER CODE.

CODICE CODE	DESCRIZIONE DESCRIPTION	Q.TÀ QTY
KR7101	TAMPONE FERMATUBO HOSE STOP	1
KR7108	BULLONE PER ATTACCO RAPIDO BOLT FOR QUICK CONNECTION	1
KR7109	SET VITI AVVOLGITUBO SET OF SCREWS HOSE REEL	1
KR7110	PERNO CENTRALE CENTRAL PIVOT	1
KR7203	DENTE D'ARRESTO DE PERNO CENTRALE	1
KR8815	KIT PORTA RULLI ROLLERS HOLDING KIT	1

ELENCO RICAMBI FORNIBILI SINGOLARMENTE

LIST OF SPARE PARTS WHICH CAN BE SUPPLIED SEPARATELY

CODICE CODE	DESCRIZIONE DESCRIPTION	Q.TÀ QTY
F694/R7035	BRACCIO ORIENTABILE SWINGING ARM	2
F695/R7035	STAFFA BRACKET	1
F957/R7035	CARTER-MOLLA COVER-SPRING GROUP	1
F958/R7035	CARTER-LATO CREMAGLIERA COVER-SPRING GROUP	1
H502	O-RING 3056 "VITON" O-RING 3056 "VITON"	1
H704	O-RING 3037 "VITON" O-RING 3037 "VITON"	1
I122	CREMAGLIERA RACK	1
I124	TAMBURO 300/350 DRUM 300/350	1
KG211	SNODO ARIA-ACQUA 20 BAR JOINT AIR-WATER 20 BAR	1
N078	MOLLA SPRING	1
P030	BOCCOLA LATO MOLLA BUSH	1
P031	BOCCOLA LATO CREMAGLIERA BUSH	1

ELENCO GUARNIZIONI SNODI

JOINTS GASKETS LIST

CODICE CODE	DESCRIZIONE DESCRIPTION	Q.TÀ QTY
H160	GUARNIZIONE OR 2093 VITON GASKET	1
H183	GUARNIZIONE GASKET	1
H370	GUARNIZIONE OR 2062 VITON GASKET	1
H395	RONDELLA WASHER	1



Art. 8292.100 Mod. 292-20 bar



VISTA ESPLOSA - EXPLODED VIEW

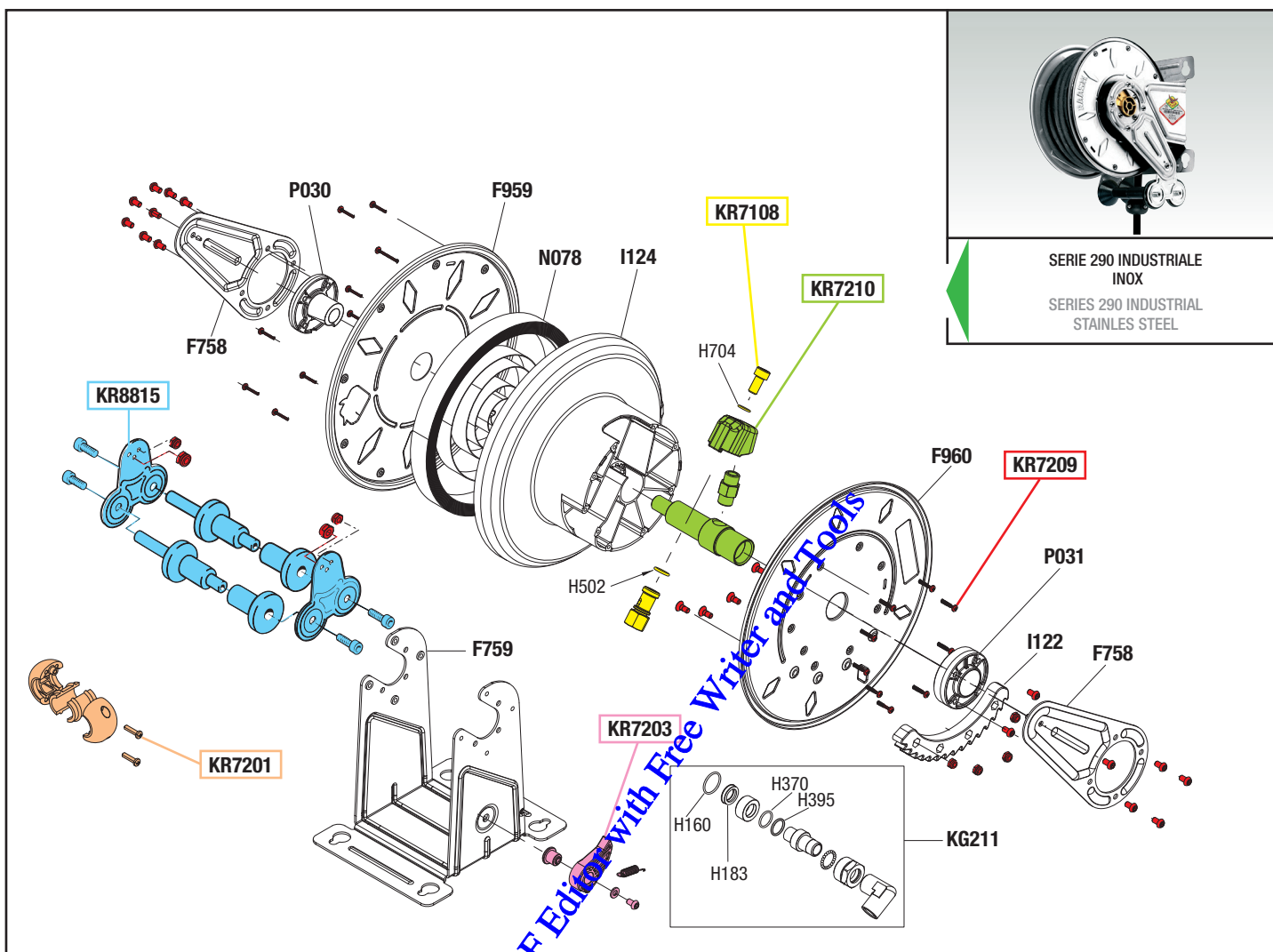

SERIE 290 INDUSTRIALE INOX
 SERIES 290 INDUSTRIAL STAINLESS STEEL

GUIDA RICAMBI - SPARE PARTS GUIDE

KIT RICAMBI
 OGNI KIT SOTTO RIPORTATO COMPRENDE I RICAMBI EVIDENZIATI CON LO STESSO COLORE E LE RELATIVE GUARNIZIONI. QUESTI RICAMBI NON SONO FORNIBILI SEPARATAMENTE TRANNE QUELLI CODIFICATI.

SPARE PARTS KITS
 EACH KIT SHOWN WITH THE SAME COLOR INCLUDES ALSO THE GASKETS. THE SPARE PARTS INCLUDED IN THE KIT CAN'T BE SUPPLIED SEPARATELY EXCEPT THOSE SHOWN WITH A PROPER CODE.

CODICE CODE	DESCRIZIONE DESCRIPTION	Q.TÀ QTY
KR7108	BULLONE PER ATTACCO RAPIDO BOLT FOR QUICK CONNECTION	1
KR7201	TAMPONE FERMATUBO PER AVVOLGITUBO HOSE STOP FOR HOSEREEL	1
KR7209	SET VITI AVVOLGITUBO SET OF SCREWS HOSEREEL	1
KR7210	PERNO CENTRALE CENTRAL PIVOT	1
KR7203	DENTE D'ARRESTO DE PERNO CENTRALE	1
KR8815	KIT PORTA RULLI ROLLERS HOLDING KIT	1

ELENCO RICAMBI FORNIBILI SINGOLARMENTE
 LIST OF SPARE PARTS WHICH CAN BE SUPPLIED SEPARATELY

CODICE CODE	DESCRIZIONE DESCRIPTION	Q.TÀ QTY
F758	BRACCIO ORIENTABILE ADJUSTABLE ARM	2
F759	SUPPORTO AVVOLGITUBO HOSEREEL SUPPORT	1
F959	CARTER-MOLLA COVER-SPRING GROUP	1
F960	CARTER-LATO CREMAGLIERA COVER-SPRING GROUP	1
H502	O-RING 3056 "VITON" O-RING 3056 "VITON"	1
H704	O-RING 3037 "VITON" O-RING 3037 "VITON"	1
I122	CREMAGLIERA RACK	1
I124	TAMBURO 300/350 DRUM 300/350	1
KG211	SNODO ARIA-ACQUA 20 BAR JOINT AIR-WATER 20 BAR	1
N078	MOLLA SPRING	1
P030	BOCCOLA LATO MOLLA BUSH	1
P031	BOCCOLA LATO CREMAGLIERA BUSH	1

ELENCO GUARNIZIONI SNODI
 JOINTS GASKETS LIST

CODICE CODE	DESCRIZIONE DESCRIPTION	Q.TÀ QTY
H160	GUARNIZIONE OR 2093 VITON GASKET	1
H183	GUARNIZIONE GASKET	1
H370	GUARNIZIONE OR 2062 VITON GASKET	1
H395	RONDELLA WASHER	1

tutti i diritti riservati - all rights reserved



Art. 8328.100 Mod. 328-20 bar - Art. 8328.105 Mod. 328-20 bar

VISTA ESPLOSA - EXPLODED VIEW

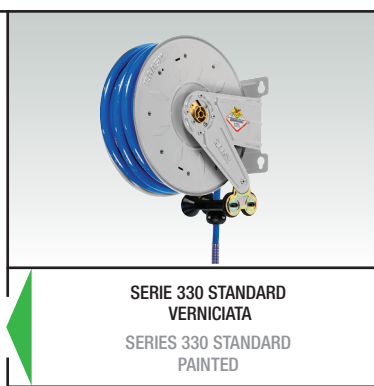
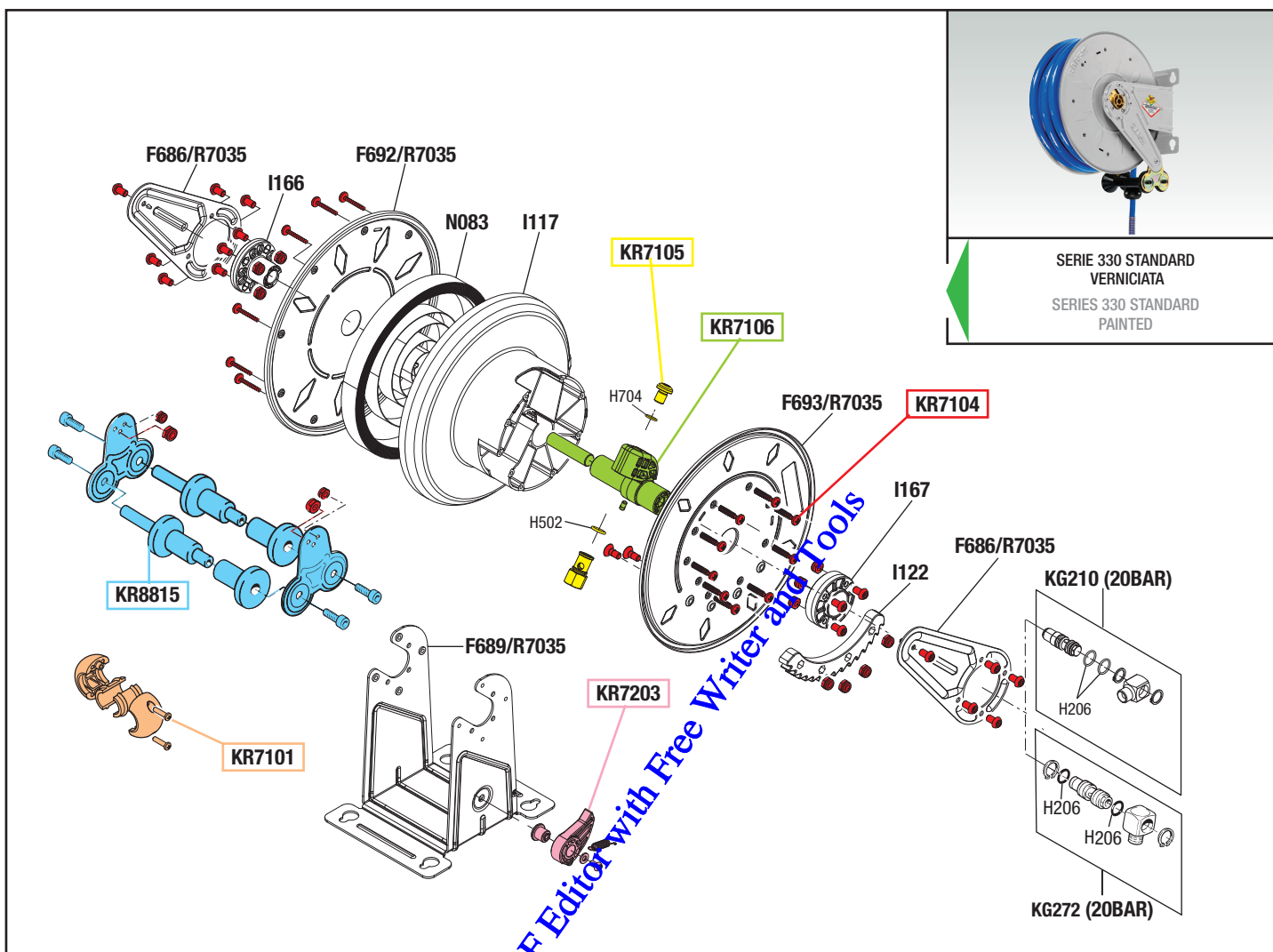

GUIDA RICAMBI - SPARE PARTS GUIDE

KIT RICAMBI
OGNI KIT SOTTO RIPORTATO COMPRENDE I RICAMBI EVIDENZIATI CON LO STESSO COLORE E LE RELATIVE GUARNIZIONI. QUESTI RICAMBI NON SONO FORNIBILI SEPARATAMENTE TRANNE QUELLI CODIFICATI.

SPARE PARTS KITS
EACH KIT SHOWN WITH THE SAME COLOR INCLUDES ALSO THE GASKETS. THE SPARE PARTS INCLUDED IN THE KIT CAN'T BE SUPPLIED SEPARATELY EXCEPT THOSE SHOWN WITH A PROPER CODE.

CODICE CODE	DESCRIZIONE DESCRIPTION	Q.TÀ QTY
KR7101	TAMPONE FERMATUBO HOSE STOP	1
KR7104	SET VITI AVVOLGITUBO HOSEREEL SCREWS KIT	1
KR7105	BULLONE PER ATTACCO RAPIDO BOLT FOR QUICK CONNECTION	1
KR7106	PERNO CENTRALE CENTRAL PIVOT	1
KR7203	DENTE DI ARRESTO DETENT	1
KR8815	KIT PORTA RULLI ROLLERS HOLDING KIT	1

ELENCO RICAMBI FORNIBILI SINGOLARMENTE
LIST OF SPARE PARTS WHICH CAN BE SUPPLIED SEPARATELY

CODICE CODE	DESCRIZIONE DESCRIPTION	Q.TÀ QTY
F686/R7035	BRACCIO ORIENTABILE ADJUSTABLE ARM	2
F689/R7035	STAFFA BRACKET	1
F692/R7035	CARTER LATO MOLLA SPRING SIDE COVER	1
F693/R7035	CARTER LATO CREMAGLIERA RACK SIDE COVER	1
H502	O-RING 3056 "VITON" O-RING 3056 "VITON"	1
H704	O-RING 3037 "VITON" O-RING 3037 "VITON"	1
I117	TAMBURO DRUM	1
I122	CREMAGLIERA RACK	1
I166	BOCCOLA LATO MOLLA SPRING SIDE BUSHING	1
I167	BOCCOLA LATO CREMAGLIERA RACK SIDE BUSH	1
KG210	SNODO DESTRO M 3/8" RIGHTJOINT M 3/8"	1
KG272	SNODO DESTRO M 1/2" RIGHTJOINT M 1/2"	1
N083	MOLLA SPRING	1

ELENCO GUARNIZIONI SNODI
JOINTS GASKETS LIST

CODICE CODE	DESCRIZIONE DESCRIPTION	Q.TÀ QTY
H206	O-RING 3043 "VITON" O-RING 3043 "VITON"	2

tutti i diritti riservati - all rights reserved



Art. 8330.100 Mod. 330-20 bar - Art. 8330.300 Mod. 330-200 bar



VISTA ESPLOSA - EXPLODED VIEW

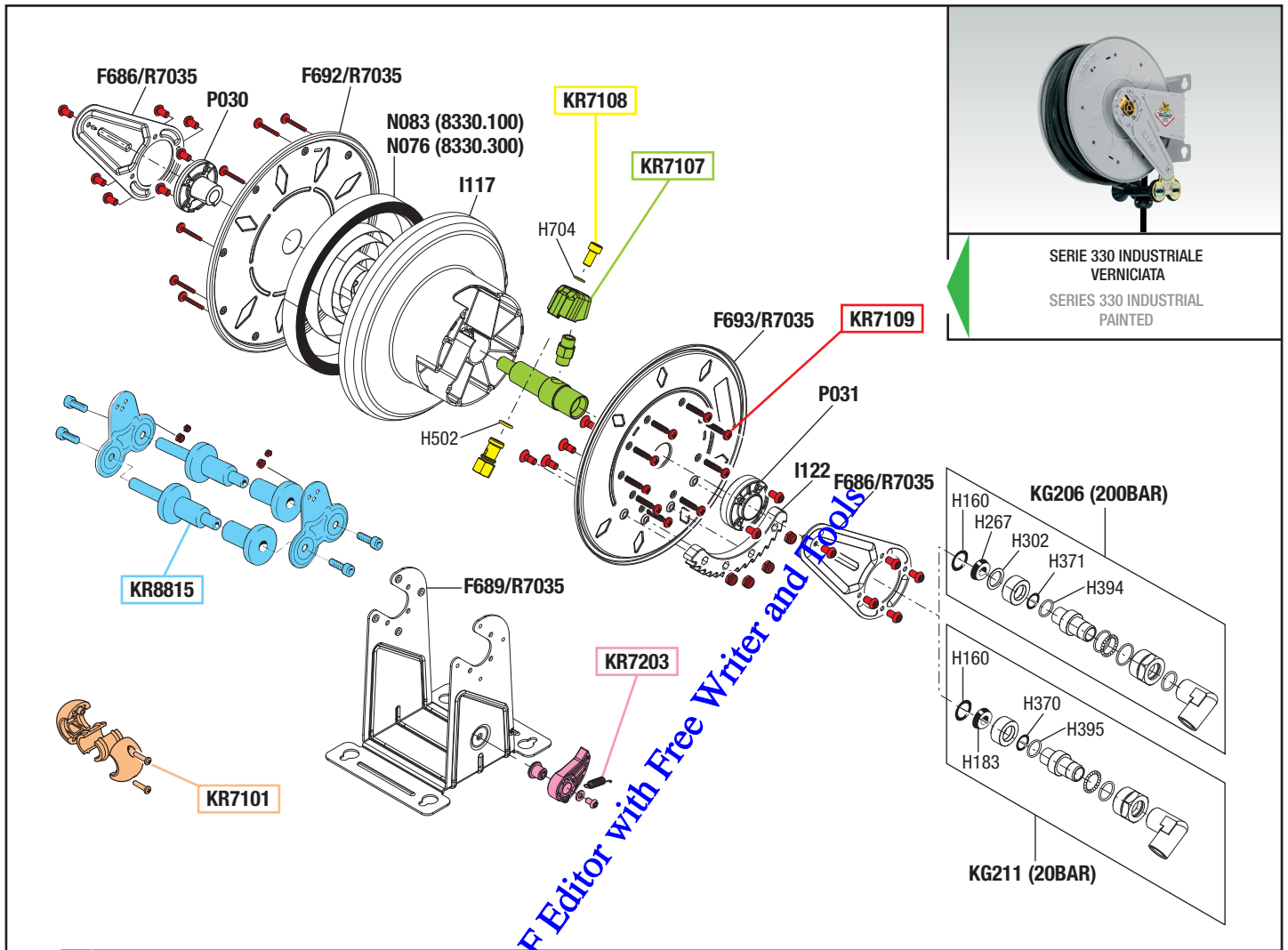

tutti i diritti riservati - all rights reserved

GUIDA RICAMBI - SPARE PARTS GUIDE

KIT RICAMBI

OGNI KIT SOTTO RIPORTATO COMPRENDE I RICAMBI EVIDENZIATI CON LO STESSO COLORE E LE RELATIVE GUARNIZIONI. QUESTI RICAMBI NON SONO FORNIBILI SEPARATAMENTE TRANNE QUELLI CODIFICATI.

SPARE PARTS KITS

EACH KIT SHOWN WITH THE SAME COLOR INCLUDES ALSO THE GASKETS. THE SPARE PARTS INCLUDED IN THE KIT CAN'T BE SUPPLIED SEPARATELY EXCEPT THOSE SHOWN WITH A PROPER CODE.

CODICE CODE	DESCRIZIONE DESCRIPTION	Q.TÀ QTY
KR7101	TAMPONE FERMATUBO HOSE STOP	1
KR7107	PERNO CENTRALE CENTRAL PIVOT	1
KR7108	BULLONE PER ATTACCO RAPIDO BOLT FOR QUICK CONNECTION	1
KR7109	SET VITI AVVOLGITUBO HOSE REEL SCREWS KIT	1
KR7203	DENTE DI ARRESTO DETENT	1
KR8815	KIT TAMPONE FERMATUBO HOSE STOP	1

ELENCO RICAMBI FORNIBILI SINGOLARMENTE

LIST OF SPARE PARTS WHICH CAN BE SUPPLIED SEPARATELY

CODICE CODE	DESCRIZIONE DESCRIPTION	Q.TÀ QTY
F686/R7035	BRACCIO ORIENTABILE ADJUSTABLE ARM	2
F689/R7035	STAFFA BRACKET	1
F692/R7035	CARTER LATO MOLLA SPRING SIDE COVER	1
F693/R7035	CARTER LATO CREMAGLIERA RACK SIDE COVER	1
H502	O-RING 3056 "VITON" O-RING 3056 "VITON"	1
H704	O-RING 3037 "VITON" O-RING 3037 "VITON"	1
I117	TAMBURO DRUM	1
I122	CREMAGLIERA RACK	1
KG206	SNODO ACQUA 200 BAR JOINT WATER 200 BAR	1
KG211	SNODO ARIA-ACQUA 20 BAR JOINT AIR-WATER 20 BAR	1
N076	MOLLA SPRING	1
N083	MOLLA SPRING	1
P030	BOCCOLA LATO MOLLA SPRING SIDE BUSH	1
P031	BOCCOLA LATO CREMAGLIERA RACK SIDE BUSH	1

ELENCO GUARNIZIONI SNODI

JOINTS GASKETS LIST

CODICE CODE	DESCRIZIONE DESCRIPTION	Q.TÀ QTY
H160	O-RING 2093 O-RING 2093	1
H183	GUARNIZIONE GASKET	1
H267	GUARNIZIONE "VITON" 90SH GASKET "VITON" 90SH	1
H302	RONDELLA IN "PTFE" WASHER "PTFE"	1
H370	O-RING 2062 "VITON" O-RING 2062 "VITON"	1
H371	O-RING 2037 "VITON" O-RING 2037 "VITON"	1
H394	RONDELLA IN "PTFE" WASHER "PTFE"	1
H395	RONDELLA IN "PTFE" WASHER "PTFE"	1



Art. 8330.200 Mod. 330-100 bar - Art. 8330.400 Mod. 330-150 bar



VISTA ESPLOSA - EXPLODED VIEW

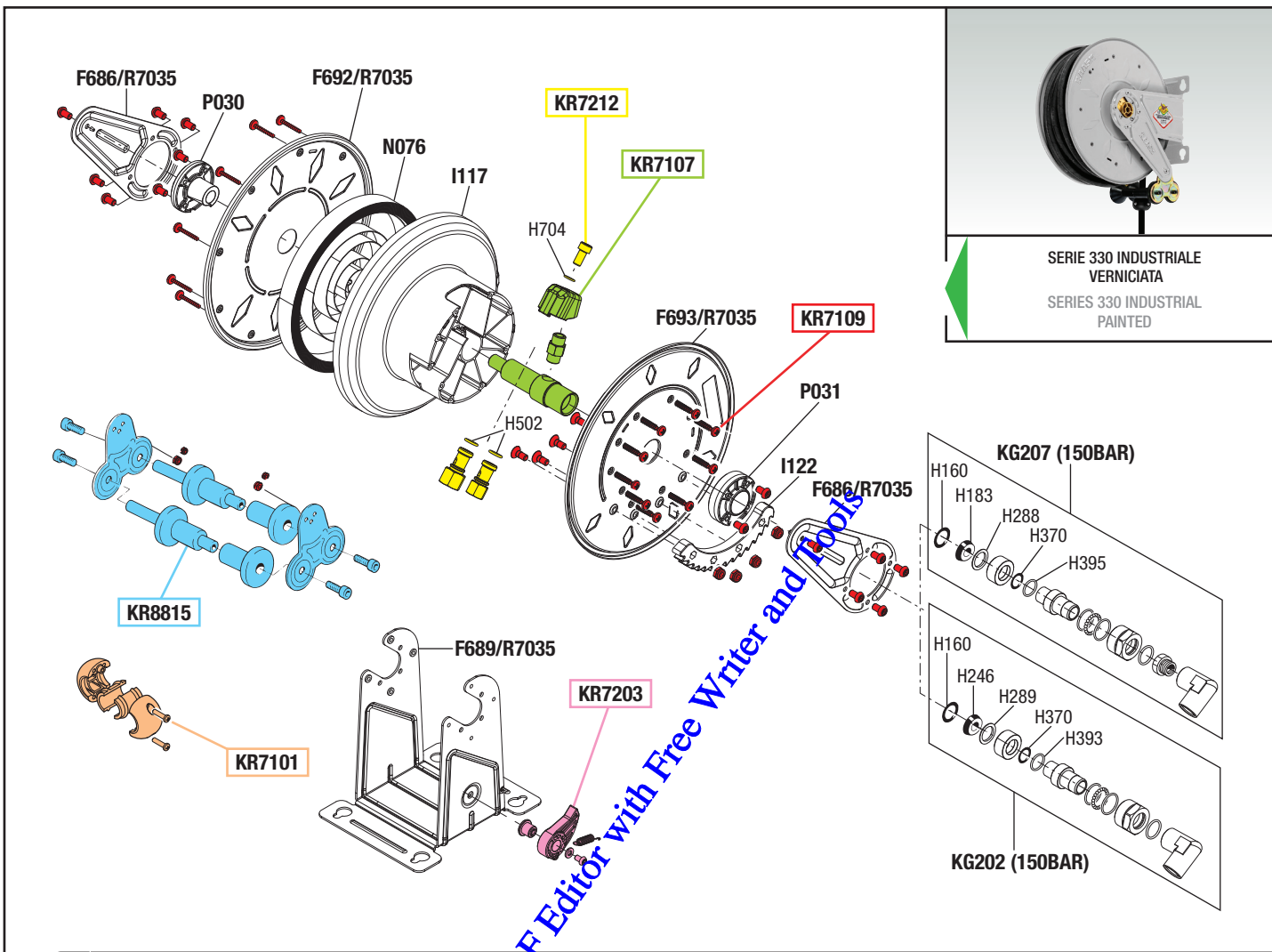

GUIDA RICAMBI - SPARE PARTS GUIDE

KIT RICAMBI
OGNI KIT SOTTO RIPORTATO COMPRENDE I RICAMBI EVIDENZIATI CON LO STESSO COLORE E LE RELATIVE GUARNIZIONI. QUESTI RICAMBI NON SONO FORNIBILI SEPARATAMENTE TRANNE QUELLI CODIFICATI.

SPARE PARTS KITS
EACH KIT SHOWN WITH THE SAME COLOR INCLUDES ALSO THE GASKETS. THE SPARE PARTS INCLUDED IN THE KIT CAN'T BE SUPPLIED SEPARATELY EXCEPT THOSE SHOWN WITH A PROPER CODE.

CODICE CODE	DESCRIZIONE DESCRIPTION	Q.TÀ QTY
KR7101	TAMPONE FERMATUBO HOSE STOP	1
KR7107	PERNO CENTRALE CENTRAL PIVOT	1
KR7109	SET VITI AVVOLGITUBO HOSEREEL SCREWS KIT	1
KR7203	DENTE DI ARRESTO DETENT	1
KR7212	BULLONE PER ATTACCO RAPIDO BOLT FOR QUICK CONNECTION	1
KR8815	KIT TAMPONE FERMATUBO HOSE STOP	1

ELENCO RICAMBI FORNIBILI SINGOLARMENTE
LIST OF SPARE PARTS WHICH CAN BE SUPPLIED SEPARATELY

CODICE CODE	DESCRIZIONE DESCRIPTION	Q.TÀ QTY
F686/R7035	BRACCIO ORIENTABILE ADJUSTABLE ARM	2
F689/R7035	STAFFA BRACKET	1
F692/R7035	CARTER LATO MOLLA SPRING SIDE COVER	1
F693/R7035	CARTER LATO CREMAGLIERA RACK SIDE COVER	1
H502	O-RING 3056 "VITON" O-RING 3056 "VITON"	2
H704	O-RING 3037 "VITON" O-RING 3037 "VITON"	1
I117	TAMBURO DRUM	1
I122	CREMAGLIERA RACK	1
KG202	SNODO OLIO 150 BAR JOINT OIL 150 BAR	1
KG207	SNODO ACQUA 100 BAR JOINT WATER 100 BAR	1
N076	MOLLA SPRING	1
P030	BOCCOLA LATO MOLLA SPRING SIDE BUSH	1
P031	BOCCOLA LATO CREMAGLIERA RACK SIDE BUSH	1

ELENCO GUARNIZIONI SNODI
JOINTS GASKETS LIST

CODICE CODE	DESCRIZIONE DESCRIPTION	Q.TÀ QTY
H160	O-RING 2093 O-RING 2093	1
H183	GUARNIZIONE GASKET	1
H246	GUARNIZIONE GASKET	1
H288	RONDELLA IN "PTFE" WASHER "PTFE"	1
H289	RONDELLA IN "PTFE" WASHER "PTFE"	1
H370	O-RING 2062 "VITON" O-RING 2062 "VITON"	1
H393	RONDELLA IN "PTFE" WASHER "PTFE"	1
H395	RONDELLA IN "PTFE" WASHER "PTFE"	1

tutti i diritti riservati - all rights reserved



Art. 8330.350 Mod. 330-400 bar



VISTA ESPLOSA - EXPLODED VIEW

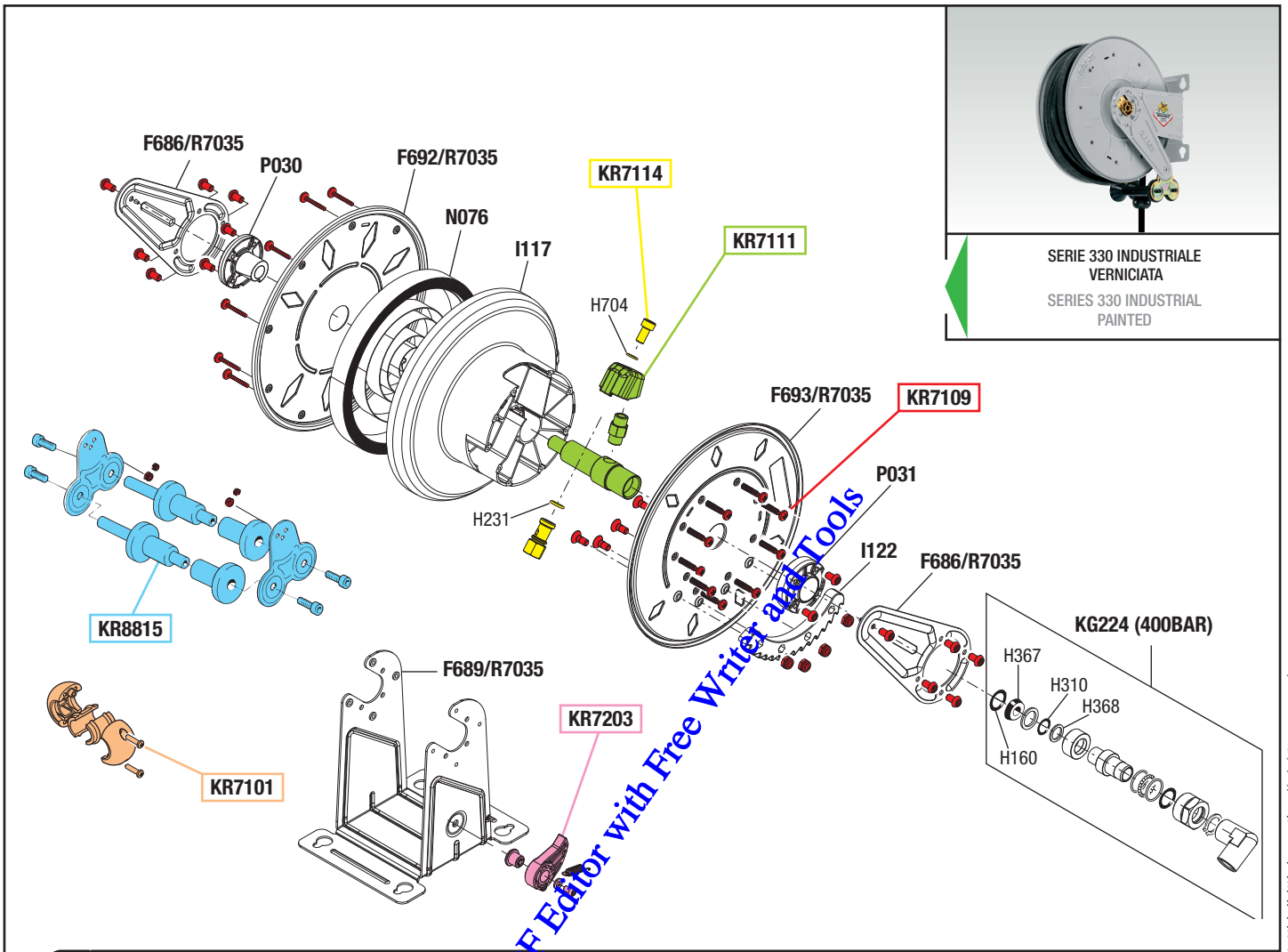

GUIDA RICAMBI - SPARE PARTS GUIDE

KIT RICAMBI
OGNI KIT SOTTO RIPORTATO COMPRENDE I RICAMBI EVIDENZIATI CON LO STESSO COLORE E LE RELATIVE GUARNIZIONI. QUESTI RICAMBI NON SONO FORNIBILI SEPARATAMENTE TRANNE QUELLI CODIFICATI.

SPARE PARTS KITS
EACH KIT SHOWN WITH THE SAME COLOR INCLUDES ALSO THE GASKETS. THE SPARE PARTS INCLUDED IN THE KIT CAN'T BE SUPPLIED SEPARATELY EXCEPT THOSE SHOWN WITH A PROPER CODE.

CODICE CODE	DESCRIZIONE DESCRIPTION	Q.TÀ QTY
KR7101	TAMPONE FERMATUBO HOSE STOP	1
KR7109	SET VITI AVVOLGITUBO HOSEREEL SCREWS KIT	1
KR7111	PERNO CENTRALE CENTRAL PIVOT	1
KR7114	BULLONE PER ATTACCO RAPIDO BOLT FOR QUICK CONNECTION	1
KR7203	DENTE DI ARRESTO DETENT	1
KR8815	KIT TAMPONE FERMATUBO HOSE STOP	1

ELENCO RICAMBI FORNIBILI SINGOLARMENTE
LIST OF SPARE PARTS WHICH CAN BE SUPPLIED SEPARATELY

CODICE CODE	DESCRIZIONE DESCRIPTION	Q.TÀ QTY
F686/R7035	BRACCIO ORIENTABILE ADJUSTABLE ARM	2
F689/R7035	STAFFA BRACKET	1
F692/R7035	CARTER LATO MOLLA SPRING SIDE COVER	1
F693/R7035	CARTER LATO CREMAGLIERA RACK SIDE COVER	1
H231	O-RING 2056	1
H704	O-RING 3037	1
I117	TAMBURO DRUM	1
I122	CREMAGLIERA RACK	1
KG224	SNODO AVVOLGITUBO HOSEREEL JOINT	1
N076	MOLLA SPRING	1
P030	BOCCOLA LATO MOLLA SPRING SIDE BUSH	1
P031	BOCCOLA LATO CREMAGLIERA RACK SIDE BUSH	1

ELENCO GUARNIZIONI SNODI
JOINTS GASKETS LIST

CODICE CODE	DESCRIZIONE DESCRIPTION	Q.TÀ QTY
H160	O-RING 2093	1
H310	O-RING 112 "VITON"	1
H367	GUARNIZIONE GASKET	1
H368	RONDELLA IN "PTFE" WASHER "PTFE"	1

tutti i diritti riservati - all rights reserved



Art. 8330.500 Mod. 330-600 bar



VISTA ESPLOSA - EXPLODED VIEW

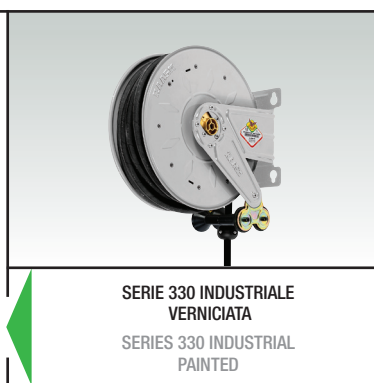
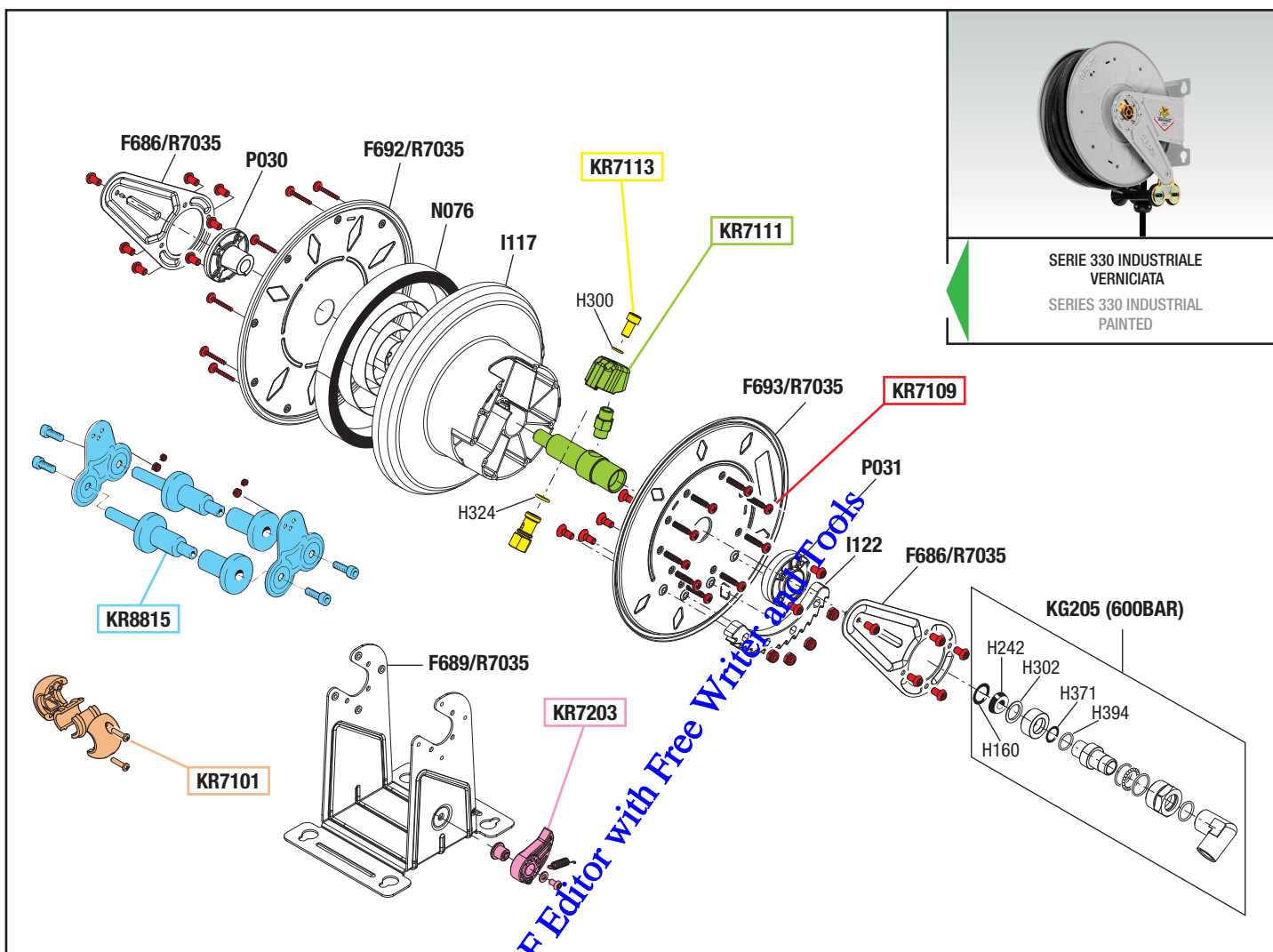

GUIDA RICAMBI - SPARE PARTS GUIDE

KIT RICAMBI
OGNI KIT SOTTO RIPORTATO COMPRENDE I RICAMBI EVIDENZIATI CON LO STESSO COLORE E LE RELATIVE GUARNIZIONI. QUESTI RICAMBI NON SONO FORNIBILI SEPARATAMENTE TRANNE QUELLI CODIFICATI.

SPARE PARTS KITS
EACH KIT SHOWN WITH THE SAME COLOR INCLUDES ALSO THE GASKETS. THE SPARE PARTS INCLUDED IN THE KIT CAN'T BE SUPPLIED SEPARATELY EXCEPT THOSE SHOWN WITH A PROPER CODE.

CODICE CODE	DESCRIZIONE DESCRIPTION	Q.TÀ QTY
KR7101	TAMPONE FERMATUBO HOSE STOP	1
KR7109	SET VITI AVVOLGITUBO HOSEREEL SCREWS KIT	1
KR7111	PERNO CENTRALE CENTRAL PIVOT	1
KR7113	BULLONE PER ATTACCO RAPIDO BOLT FOR QUICK CONNECTION	1
KR7203	DENTE DI ARRESTO DETENT	1
KR8815	KIT TAMPONE FERMATUBO HOSE STOP	1

ELENCO RICAMBI FORNIBILI SINGOLARMENTE
LIST OF SPARE PARTS WHICH CAN BE SUPPLIED SEPARATELY

CODICE CODE	DESCRIZIONE DESCRIPTION	Q.TÀ QTY
F686/R7035	BRACCIO ORIENTABILE ADJUSTABLE ARM	2
F689/R7035	STAFFA BRACKET	1
F692/R7035	CARTER LATO MOLLA SPRING SIDE COVER	1
F693/R7035	CARTER LATO CREMAGLIERA RACK SIDE COVER	1
H300	O-RING 3037 O-RING 3037	1
H324	O-RING 2056 O-RING 2056	1
I117	TAMBURO DRUM	1
I122	CREMAGLIERA RACK	1
KG205	SNODO AVVOLGITUBO HOSEREEL JOINT	1
N076	MOLLA SPRING	1
P030	BOCCOLA LATO MOLLA SPRING SIDE BUSH	1
P031	BOCCOLA LATO CREMAGLIERA RACK SIDE BUSH	1

ELENCO GUARNIZIONI SNODI
JOINTS GASKETS LIST

CODICE CODE	DESCRIZIONE DESCRIPTION	Q.TÀ QTY
H160	O-RING 2093 O-RING 2093	1
H242	GUARNIZIONE GASKET	1
H302	RONDELLA IN "PTFE" WASHER "PTFE"	1
H371	O-RING 2037 "VITON" O-RING 2037 "VITON"	1
H394	RONDELLA IN "PTFE" WASHER "PTFE"	1

tutti i diritti riservati - all rights reserved



Art. 8330.800 Mod. 330G-20 bar



VISTA ESPLOSA - EXPLODED VIEW

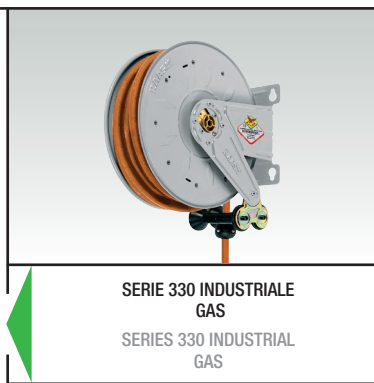
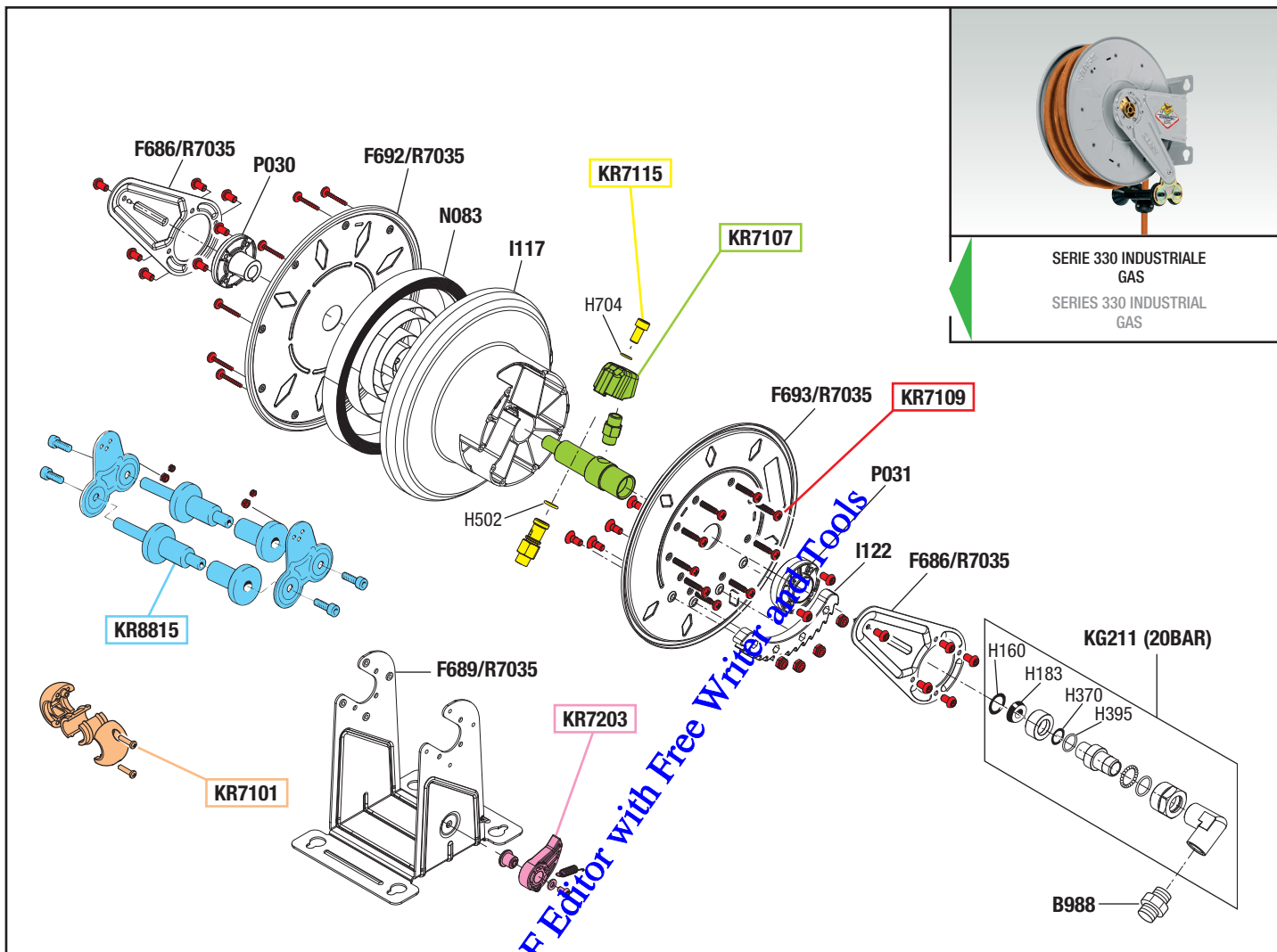

GUIDA RICAMBI - SPARE PARTS GUIDE

KIT RICAMBI
OGNI KIT SOTTO RIPORTATO COMPRENDE I RICAMBI EVIDENZIATI CON LO STESSO COLORE E LE RELATIVE GUARNIZIONI. QUESTI RICAMBI NON SONO FORNIBILI SEPARATAMENTE TRANNE QUELLI CODIFICATI.

SPARE PARTS KITS
EACH KIT SHOWN WITH THE SAME COLOR INCLUDES ALSO THE GASKETS. THE SPARE PARTS INCLUDED IN THE KIT CAN'T BE SUPPLIED SEPARATELY EXCEPT THOSE SHOWN WITH A PROPER CODE.

CODICE CODE	DESCRIZIONE DESCRIPTION	Q.TÀ QTY
KR7101	TAMPONE FERMATUBO HOSE STOP	1
KR7107	PERNO CENTRALE CENTRAL PIVOT	1
KR7109	SET VITI AVVOLGITUBO HOSEREEL SCREWS KIT	1
KR7115	BULLONE PER ATTACCO RAPIDO BOLT FOR QUICK CONNECTION	1
KR7203	DENTE DI ARRESTO DETENT	1
KR8815	KIT TAMPONE FERMATUBO HOSE STOP	1

ELENCO RICAMBI FORNIBILI SINGOLARMENTE
LIST OF SPARE PARTS WHICH CAN BE SUPPLIED SEPARATELY

CODICE CODE	DESCRIZIONE DESCRIPTION	Q.TÀ QTY
B988	NIPPLE M 3/8" G sx - M 3/8" G dx NIPPLE M 3/8" G left - M 3/8" G right	1
F686/R7035	BRACCIO ORIENTABILE ADJUSTABLE ARM	2
F689/R7035	STAFFA BRACKET	1
F692/R7035	CARTER LATO MOLLA SPRING SIDE COVER	1
F693/R7035	CARTER LATO CREMAGLIERA RACK SIDE COVER	1
H502	O-RING 3056 "VITON" O-RING 3056 "VITON"	1
H704	O-RING 3037 O-RING 3037	1
I117	TAMBURO DRUM	1
I122	CREMAGLIERA RACK	1
KG211	SNODO ARIA-ACQUA 20 BAR JOINT AIR-WATER 20 BAR	1
N083	MOLLA SPRING	1
P030	BOCCOLA LATO MOLLA SPRING SIDE BUSH	1
P031	BOCCOLA LATO CREMAGLIERA RACK SIDE BUSH	1

ELENCO GUARNIZIONI SNODI
JOINTS GASKETS LIST

CODICE CODE	DESCRIZIONE DESCRIPTION	Q.TÀ QTY
H160	O-RING 2093 O-RING 2093	1
H183	GUARNIZIONE GASKET	1
H370	O-RING 2062 "VITON" O-RING 2062 "VITON"	1
H395	RONDELLA IN "PTFE" WASHER "PTFE"	1

tutti i diritti riservati - all rights reserved



Art. 8332.100 Mod. 332-20 bar - Art. 8332.300 Mod. 332-200 bar

VISTA ESPLOSA - EXPLODED VIEW

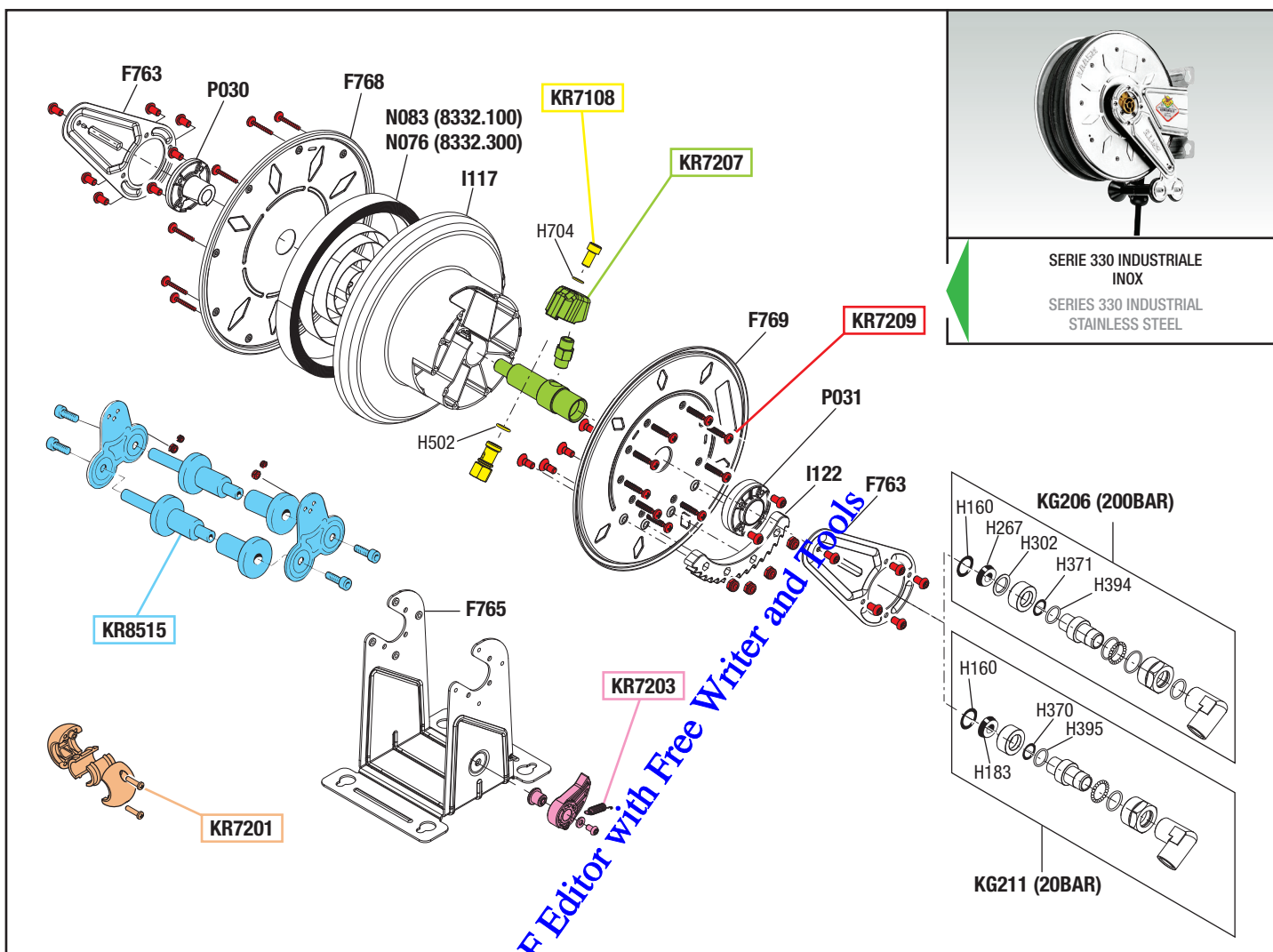

GUIDA RICAMBI - SPARE PARTS GUIDE

KIT RICAMBI
OGNI KIT SOTTO RIPORTATO COMPRENDE I RICAMBI EVIDENZIATI CON LO STESSO COLORE E LE RELATIVE GUARNIZIONI. QUESTI RICAMBI NON SONO FORNIBILI SEPARATAMENTE TRANNE QUELLI CODIFICATI.

SPARE PARTS KITS
EACH KIT SHOWN WITH THE SAME COLOR INCLUDES ALSO THE GASKETS. THE SPARE PARTS INCLUDED IN THE KIT CAN'T BE SUPPLIED SEPARATELY EXCEPT THOSE SHOWN WITH A PROPER CODE.

CODICE CODE	DESCRIZIONE DESCRIPTION	Q.TÀ QTY
KR7108	BULLONE PER ATTACCO RAPIDO BOLT FOR QUICK CONNECTION	1
KR7201	TAMPONE FERMATUBO HOSE STOP	1
KR7203	DENTE DI ARRESTO DETENT	1
KR7207	PERNO CENTRALE CENTRAL PIVOT	1
KR7209	SET VITI AVVOLGITUBO HOSE REEL SCREWS KIT	1
KR8515	KIT PORTA RULLI AVVOLGITUBO ROLLERS HOLDING KIT FOR HOSE REEL	1

ELENCO RICAMBI FORNIBILI SINGOLARMENTE
LIST OF SPARE PARTS WHICH CAN BE SUPPLIED SEPARATELY

CODICE CODE	DESCRIZIONE DESCRIPTION	Q.TÀ QTY
F763	BRACCIO ORIENTABILE ADJUSTABLE ARM	2
F765	STAFFA BRACKET	1
F768	CARTER LATO MOLLA COVER SPRING SIDE	1
F769	CARTER LATO CREMAGLIERA RACK SIDE COVER	1
H502	O-RING 3056 "VITON" O-RING 3056 "VITON"	1
H704	O-RING 3037 O-RING 3037	1
I117	TAMBURO DRUM	1
I122	CREMAGLIERA RACK	1
KG206	SNODO ACQUA 200 BAR JOINT WATER 200 BAR	1
KG211	SNODO ARIA-ACQUA 20 BAR JOINT AIR-WATER 20 BAR	1
N076	MOLLA SPRING	1
N083	MOLLA SPRING	1
P030	BOCCOLA LATO MOLLA SPRING SIDE BUSH	1
P031	BOCCOLA LATO CREMAGLIERA RACK SIDE BUSH	1

ELENCO GUARNIZIONI SNODI
JOINTS GASKETS LIST

CODICE CODE	DESCRIZIONE DESCRIPTION	Q.TÀ QTY
H160	O-RING 2093 O-RING 2093	1
H183	GUARNIZIONE GASKET	1
H267	GUARNIZIONE "VITON" 90SH GASKET "VITON" 90SH	1
H302	RONDELLA IN "PTFE" WASHER "PTFE"	1
H370	O-RING 2062 "VITON" O-RING 2062 "VITON"	1
H371	O-RING 2037 "VITON" O-RING 2037 "VITON"	1
H394	RONDELLA IN "PTFE" WASHER "PTFE"	1
H395	RONDELLA IN "PTFE" WASHER "PTFE"	1

tutti i diritti riservati - all rights reserved



Art. 8332.350 Mod. 332-400 bar



VISTA ESPLOSA - EXPLODED VIEW

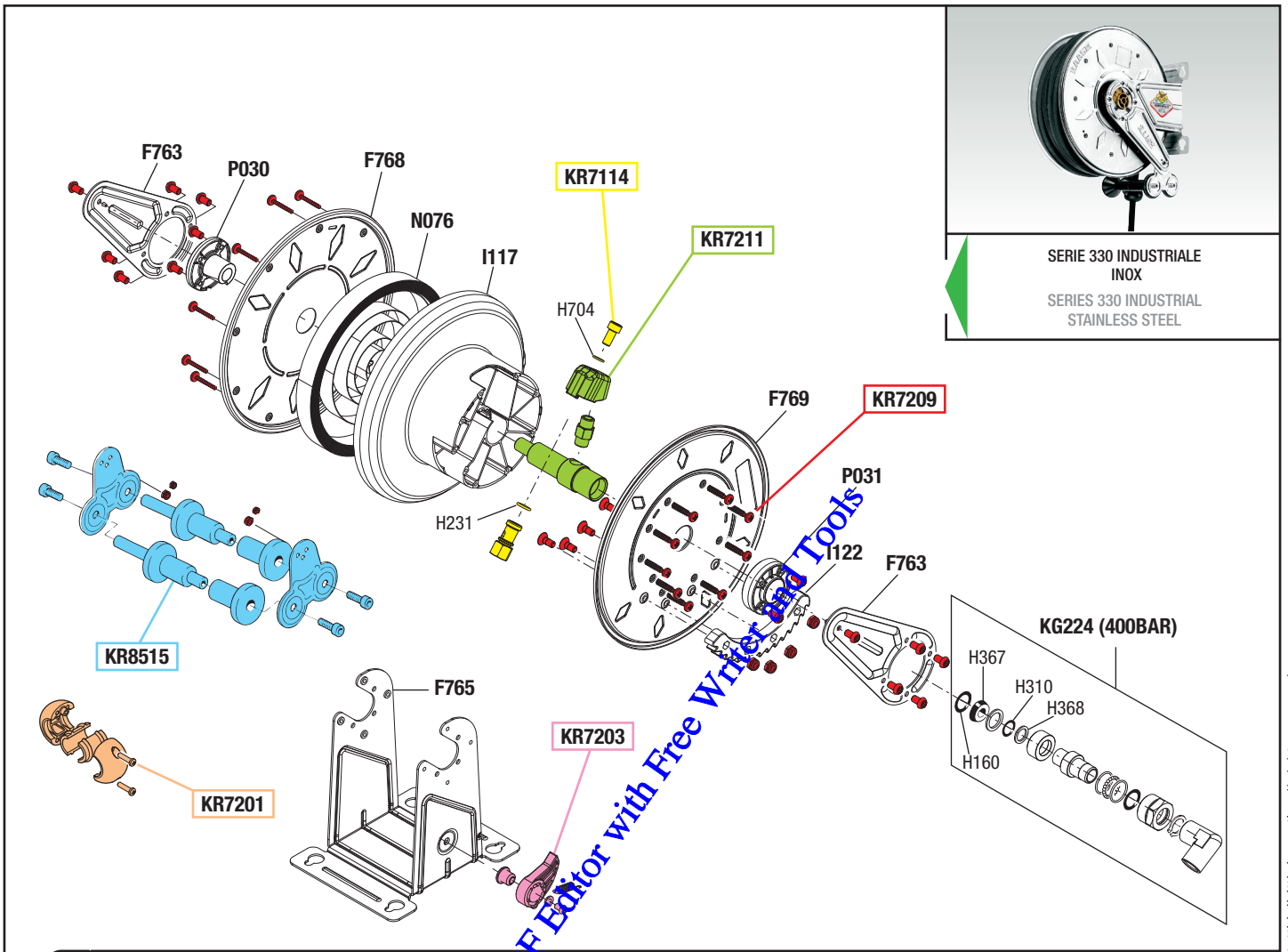

GUIDA RICAMBI - SPARE PARTS GUIDE

KIT RICAMBI
OGNI KIT SOTTO RIPORTATO COMPRENDE I RICAMBI EVIDENZIATI CON LO STESSO COLORE E LE RELATIVE GUARNIZIONI. QUESTI RICAMBI NON SONO FORNIBILI SEPARATAMENTE TRANNE QUELLI CODIFICATI.

SPARE PARTS KITS
EACH KIT SHOWN WITH THE SAME COLOR INCLUDES ALSO THE GASKETS. THE SPARE PARTS INCLUDED IN THE KIT CAN'T BE SUPPLIED SEPARATELY EXCEPT THOSE SHOWN WITH A PROPER CODE.

CODICE CODE	DESCRIZIONE DESCRIPTION	Q.TÀ QTY
KR7114	BULLONE PER ATTACCO RAPIDO BOLT FOR QUICK CONNECTION	1
KR7201	TAMPONE FERMATUBO HOSE STOP	1
KR7203	DENTE DI ARRESTO DETENT	1
KR7209	SET VITI AVVOLGITUBO HOSEREEL SCREWS KIT	1
KR7211	PERNO CENTRALE CENTRAL PIVOT	1
KR8515	KIT PORTA RULLI AVVOLGITUBO ROLLERS HOLDING KIT FOR HOSEREEL	1

ELENCO RICAMBI FORNIBILI SINGOLARMENTE
LIST OF SPARE PARTS WHICH CAN BE SUPPLIED SEPARATELY

CODICE CODE	DESCRIZIONE DESCRIPTION	Q.TÀ QTY
F763	BRACCIO ORIENTABILE ADJUSTABLE ARM	2
F765	STAFFA BRACKET	1
F768	CARTER LATO MOLLA COVER SPRING SIDE	1
F769	CARTER LATO CREMAGLIERA RACK SIDE COVER	1
H231	O-RING 2056 "VITON" O-RING 2056 "VITON"	1
H704	O-RING 3037 "VITON" O-RING 3037 "VITON"	1
I117	TAMBURO DRUM	1
I122	CREMAGLIERA RACK	1
KG224	SNODO AVVOLGITUBO HOSEREEL JOINT	1
N076	MOLLA SPRING	1
P030	BOCCOLA LATO MOLLA SPRING SIDE BUSH	1
P031	BOCCOLA LATO CREMAGLIERA RACK SIDE BUSH	1

ELENCO GUARNIZIONI SNODI
JOINTS GASKETS LIST

CODICE CODE	DESCRIZIONE DESCRIPTION	Q.TÀ QTY
H160	O-RING 2093 O-RING 2093	1
H310	O-RING 112 "VITON" O-RING 112 "VITON"	1
H367	GUARNIZIONE GASKET	1
H368	RONDELLA IN "PTFE" WASHER "PTFE"	1

tutti i diritti riservati - all rights reserved



Art. 8332.400 Mod. 332-150 bar



VISTA ESPLOSA - EXPLODED VIEW

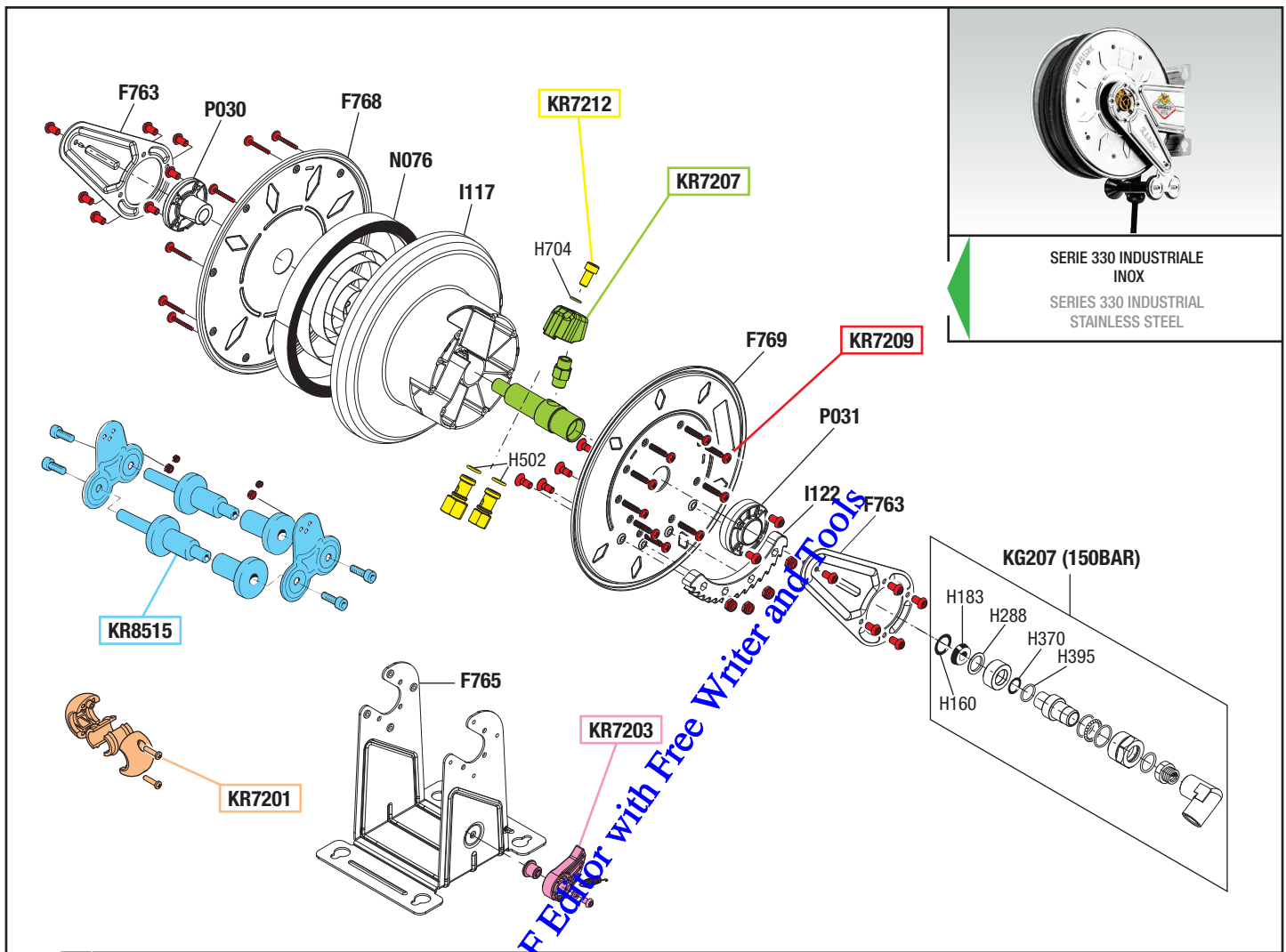

SERIE 330 INDUSTRIALE
INOX
SERIES 330 INDUSTRIAL
STAINLESS STEEL

KG207 (150BAR)

tutti i diritti riservati - all rights reserved

GUIDA RICAMBI - SPARE PARTS GUIDE

KIT RICAMBI

OGNI KIT SOTTO RIPORTATO COMPRENDE I RICAMBI EVIDENZIATI CON LO STESSO COLORE E LE RELATIVE GUARNIZIONI. QUESTI RICAMBI NON SONO FORNIBILI SEPARATAMENTE TRANNE QUELLI CODIFICATI.

SPARE PARTS KITS

EACH KIT SHOWN WITH THE SAME COLOR INCLUDES ALSO THE GASKETS. THE SPARE PARTS INCLUDED IN THE KIT CAN'T BE SUPPLIED SEPARATELY EXCEPT THOSE SHOWN WITH A PROPER CODE.

CODICE CODE	DESCRIZIONE DESCRIPTION	Q.TÀ QTY
KR7201	TAMPONE FERMATUBO HOSE STOP	1
KR7203	DENTE DI ARRESTO DETENT	1
KR7207	PERNO CENTRALE CENTRAL PIVOT	1
KR7209	SET VITI AVVOLGITUBO HOSEREEL SCREWS KIT	1
KR7212	BULLONE PER ATTACCO RAPIDO BOLT FOR QUICK CONNECTION	1
KR8515	KIT TAMPONE FERMATUBO HOSE STOP	1

ELENCO RICAMBI FORNIBILI SINGOLARMENTE

LIST OF SPARE PARTS WHICH CAN BE SUPPLIED SEPARATELY

CODICE CODE	DESCRIZIONE DESCRIPTION	Q.TÀ QTY
F763	BRACCIO ORIENTABILE ADJUSTABLE ARM	2
F765	STAFFA BRACKET	1
F768	CARTER LATO MOLLA COVER SPRING SIDE	1
F769	CARTER LATO CREMAGLIERA RACK SIDE COVER	1
H502	O-RING 3056 "VITON" O-RING 3056 "VITON"	2
H704	O-RING 3037 "VITON" O-RING 3037 "VITON"	1
I117	TAMBURO DRUM	1
I122	CREMAGLIERA RACK	1
KG207	SNODO AVVOLGITUBO HOSEREEL JOINT	1
N076	MOLLA SPRING	1
P030	BOCCOLA LATO MOLLA SPRING SIDE BUSH	1
P031	BOCCOLA LATO CREMAGLIERA RACK SIDE BUSH	1

ELENCO GUARNIZIONI SNODI

JOINTS GASKETS LIST

CODICE CODE	DESCRIZIONE DESCRIPTION	Q.TÀ QTY
H160	O-RING 2093 O-RING 2093	1
H183	GUARNIZIONE GASKET	1
H288	RONDELLA IN "PTFE" WASHER "PTFE"	1
H370	O-RING 2062 "VITON" O-RING 2062 "VITON"	1
H395	RONDELLA IN "PTFE" WASHER "PTFE"	1



Art. 8332.500 Mod. 332-600 bar



VISTA ESPLOSA - EXPLODED VIEW

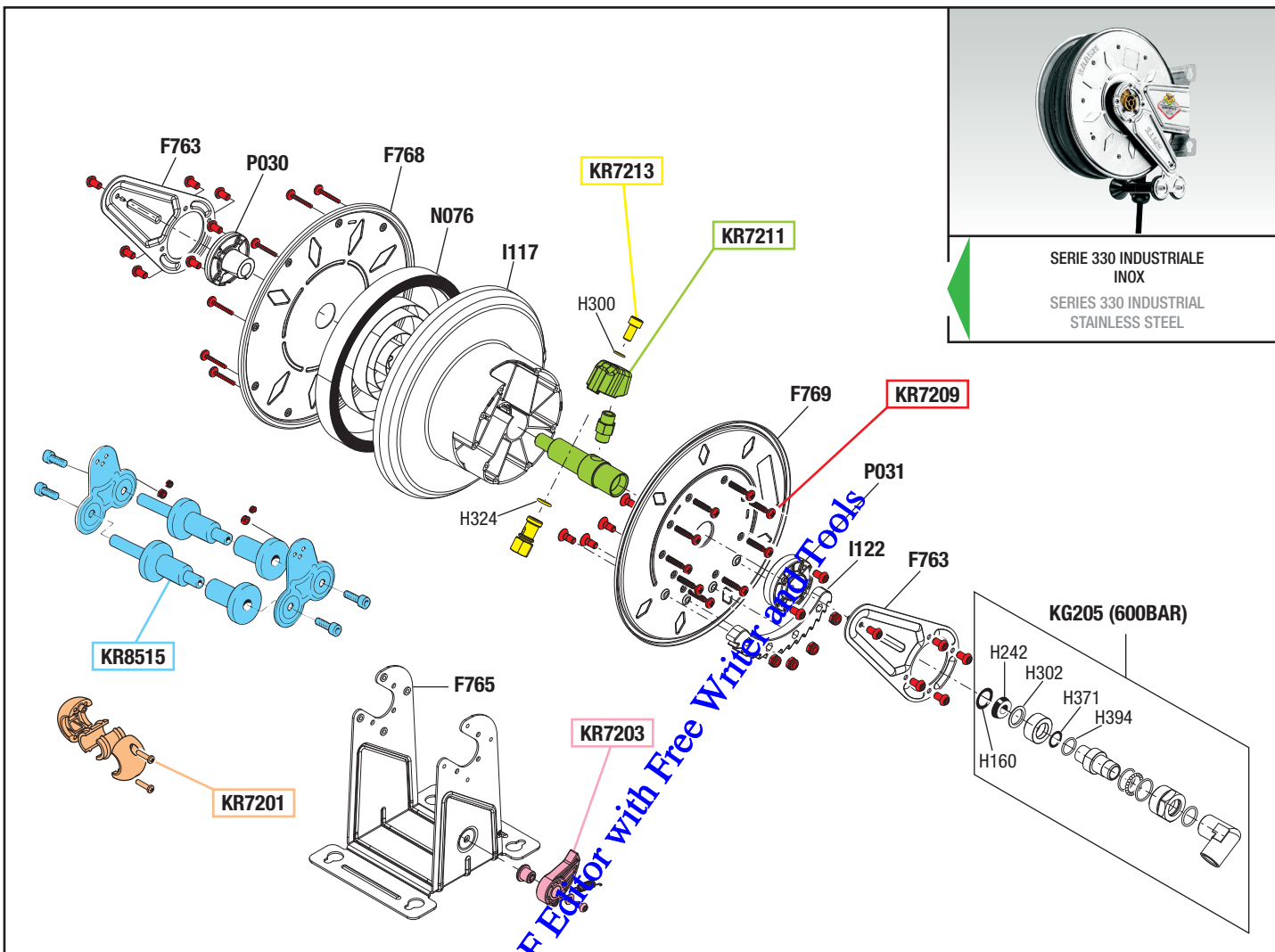

GUIDA RICAMBI - SPARE PARTS GUIDE

KIT RICAMBI
OGNI KIT SOTTO RIPORTATO COMPRENDE I RICAMBI EVIDENZIATI CON LO STESSO COLORE E LE RELATIVE GUARNIZIONI. QUESTI RICAMBI NON SONO FORNIBILI SEPARATAMENTE TRANNE QUELLI CODIFICATI.

SPARE PARTS KITS
EACH KIT SHOWN WITH THE SAME COLOR INCLUDES ALSO THE GASKETS. THE SPARE PARTS INCLUDED IN THE KIT CAN'T BE SUPPLIED SEPARATELY EXCEPT THOSE SHOWN WITH A PROPER CODE.

CODICE CODE	DESCRIZIONE DESCRIPTION	Q.TÀ QTY
KR7201	TAMPONE FERMATUBO HOSE STOP	1
KR7203	DENTE DI ARRESTO DETENT	1
KR7209	SET VITI AVVOLGITUBO HOSEREEL SCREWS KIT	1
KR7211	PERNO CENTRALE CENTRAL PIVOT	1
KR7213	BULLONE PER ATTACCO RAPIDO BOLT FOR QUICK CONNECTION	1
KR8515	KIT PORTA RULLI AVVOLGITUBO ROLLERS HOLDING KIT FOR HOSEREEL	1

ELENCO RICAMBI FORNIBILI SINGOLARMENTE
LIST OF SPARE PARTS WHICH CAN BE SUPPLIED SEPARATELY

CODICE CODE	DESCRIZIONE DESCRIPTION	Q.TÀ QTY
F763	BRACCIO ORIENTABILE ADJUSTABLE ARM	2
F765	STAFFA BRACKET	1
F768	CARTER LATO MOLLA COVER SPRING SIDE	1
F769	CARTER LATO CREMAGLIERA RACK SIDE COVER	1
H300	O-RING 3037 O-RING 3037	1
H324	O-RING 2056 O-RING 2056	1
I117	TAMBURO DRUM	1
I122	CREMAGLIERA RACK	1
KG205	SNODO AVVOLGITUBO HOSEREEL JOINT	1
N076	MOLLA SPRING	1
P030	BOCCOLA LATO MOLLA SPRING SIDE BUSH	1
P031	BOCCOLA LATO CREMAGLIERA RACK SIDE BUSH	1

ELENCO GUARNIZIONI SNODI
JOINTS GASKETS LIST

CODICE CODE	DESCRIZIONE DESCRIPTION	Q.TÀ QTY
H160	O-RING 2093 O-RING 2093	1
H242	GUARNIZIONE GASKET	1
H302	RONDELLA IN "PTFE" WASHER "PTFE"	1
H371	O-RING 2037 "VITON" O-RING 2037 "VITON"	1
H394	RONDELLA IN "PTFE" WASHER "PTFE"	1

tutti i diritti riservati - all rights reserved



Art. 8332.800 Mod. 332G-20 bar



VISTA ESPLOSA - EXPLODED VIEW

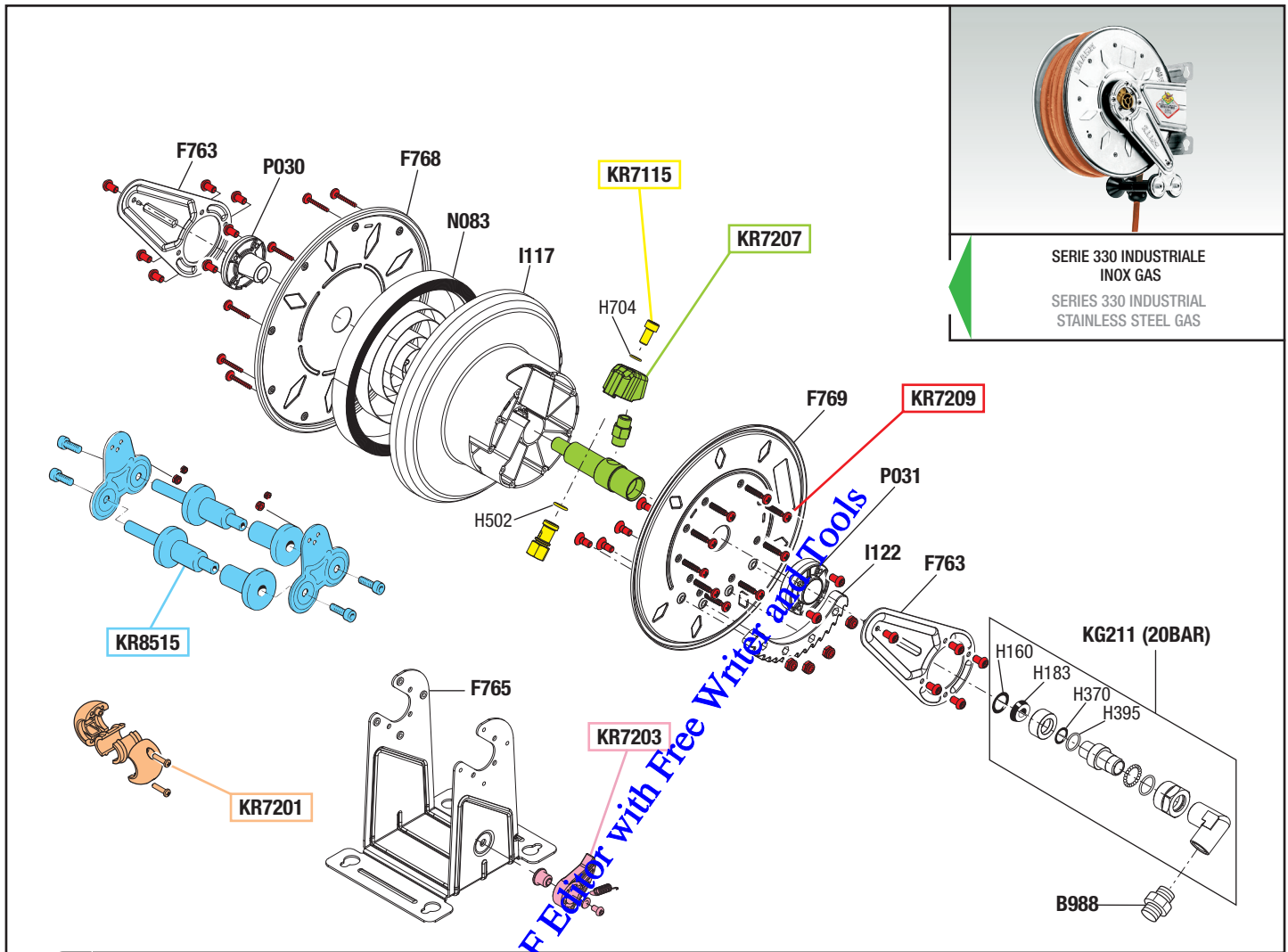

SERIE 330 INDUSTRIALE
INOX GAS
SERIES 330 INDUSTRIAL
STAINLESS STEEL GAS

tutti i diritti riservati - all rights reserved

GUIDA RICAMBI - SPARE PARTS GUIDE

KIT RICAMBI

OGNI KIT SOTTO RIPORTATO COMPRENDE I RICAMBI EVIDENZIATI CON LO STESSO COLORE E LE RELATIVE GUARNIZIONI. QUESTI RICAMBI NON SONO FORNIBILI SEPARATAMENTE TRANNE QUELLI CODIFICATI.

SPARE PARTS KITS

EACH KIT SHOWN WITH THE SAME COLOR INCLUDES ALSO THE GASKETS. THE SPARE PARTS INCLUDED IN THE KIT CAN'T BE SUPPLIED SEPARATELY EXCEPT THOSE SHOWN WITH A PROPER CODE.

CODICE CODE	DESCRIZIONE DESCRIPTION	Q.TÀ QTY
KR7115	BULLONE PER ATTACCO RAPIDO BOLT FOR QUICK CONNECTION	1
KR7201	TAMPONE FERMATUBO HOSE STOP	1
KR7203	DENTE DI ARRESTO DETENT	1
KR7207	PERNO CENTRALE CENTRAL PIVOT	1
KR7209	SET VITI AVVOLGITUBO HOSE REEL SCREWS KIT	1
KR8515	KIT PORTA RULLI AVVOLGITUBO ROLLERS HOLDING KIT FOR HOSE REEL	1

ELENCO RICAMBI FORNIBILI SINGOLARMENTE
LIST OF SPARE PARTS WHICH CAN BE SUPPLIED SEPARATELY

CODICE CODE	DESCRIZIONE DESCRIPTION	Q.TÀ QTY
B988	NIPPLE M 3/8" G sx - M 3/8" G dx NIPPLE M 3/8" G left - M 3/8" G right	1
F763	BRACCIO ORIENTABILE ADJUSTABLE ARM	2
F765	STAFFA BRACKET	1
F768	CARTER LATO MOLLA COVER SPRING SIDE	1
F769	CARTER LATO CREMAGLIERA RACK SIDE COVER	1
H502	O-RING 3056 "VITON" O-RING 3056 "VITON"	1
H704	O-RING 3037 "VITON" O-RING 3037 "VITON"	1
I117	TAMBURO DRUM	1
I122	CREMAGLIERA RACK	1
KG211	SNODO ARIA-ACQUA 20 BAR JOINT AIR-WATER 20 BAR	1
N083	MOLLA SPRING	1
P030	BOCCOLA LATO MOLLA SPRING SIDE BUSH	1
P031	BOCCOLA LATO CREMAGLIERA RACK SIDE BUSH	1

ELENCO GUARNIZIONI SNODI

JOINTS GASKETS LIST

CODICE CODE	DESCRIZIONE DESCRIPTION	Q.TÀ QTY
H160	O-RING 2093 O-RING 2093	1
H183	GUARNIZIONE GASKET	1
H370	O-RING 2062 "VITON" O-RING 2062 "VITON"	1
H395	RONDELLA IN "PTFE" WASHER "PTFE"	1



Art. 8378.100 Mod. 378-20 bar - Art. 8378.105 Mod. 378-20 bar

VISTA ESPLOSA - EXPLODED VIEW

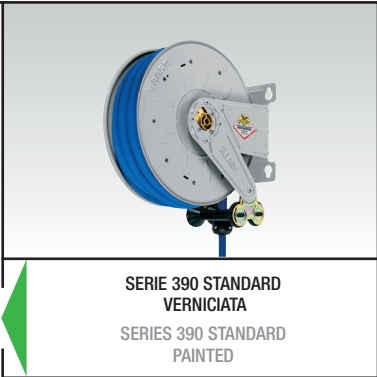
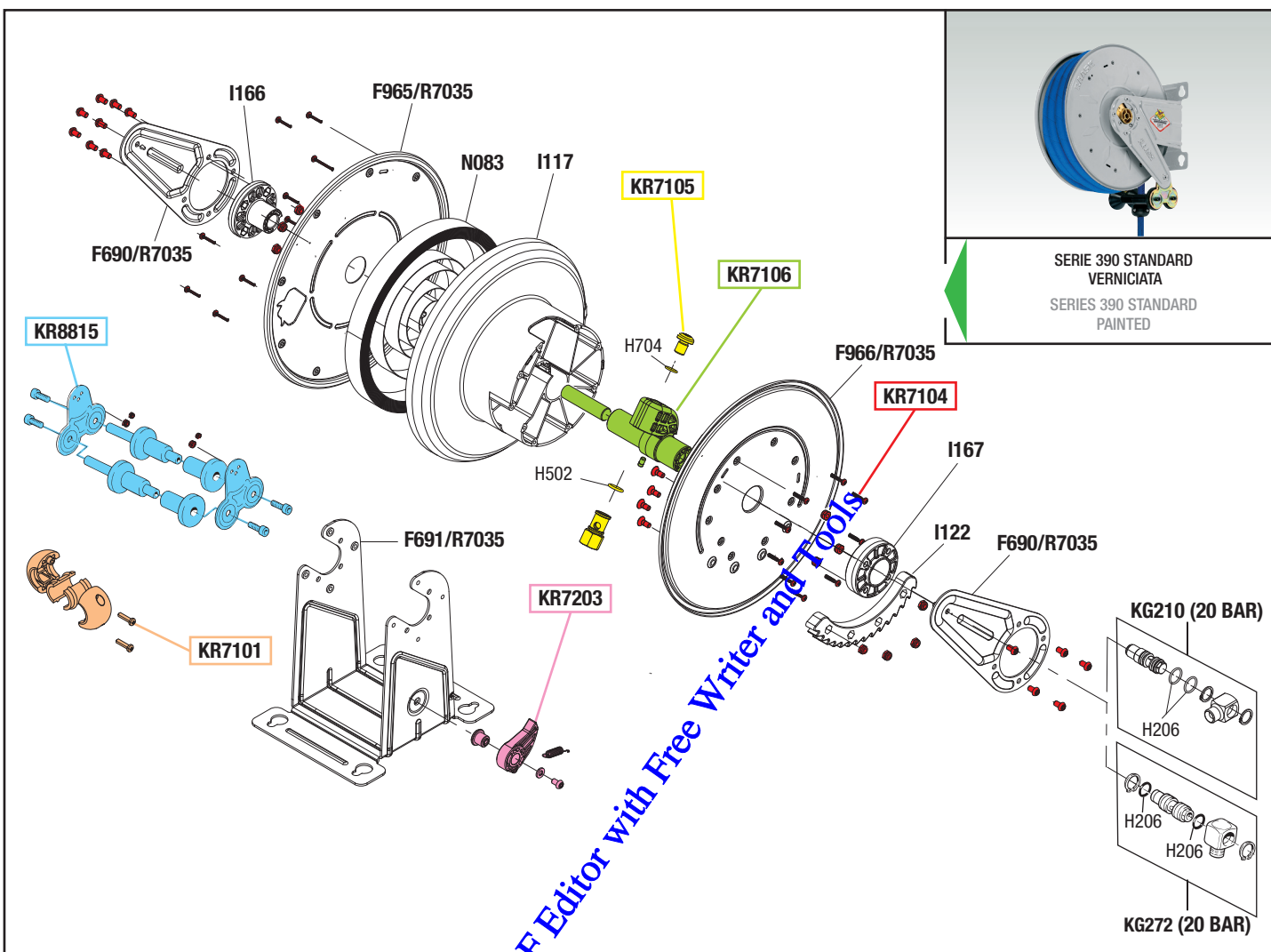

GUIDA RICAMBI - SPARE PARTS GUIDE

KIT RICAMBI
OGNI KIT SOTTO RIPORTATO COMPRENDE I RICAMBI EVIDENZIATI CON LO STESSO COLORE E LE RELATIVE GUARNIZIONI. QUESTI RICAMBI NON SONO FORNIBILI SEPARATAMENTE TRANNE QUELLI CODIFICATI.

SPARE PARTS KITS
EACH KIT SHOWN WITH THE SAME COLOR INCLUDES ALSO THE GASKETS. THE SPARE PARTS INCLUDED IN THE KIT CAN'T BE SUPPLIED SEPARATELY EXCEPT THOSE SHOWN WITH A PROPER CODE.

CODICE CODE	DESCRIZIONE DESCRIPTION	Q.TÀ QTY
KR7101	TAMPONE FERMATUBO HOSE STOP	1
KR7104	SET VITI AVVOLGITUBO SET OF SCREWS HOSE REEL	1
KR7105	BULLONE PER ATTACCO RAPIDO BOLT FOR QUICK CONNECTION	1
KR7106	PERNO CENTRALE CENTRAL PIVOT	1
KR7203	DENTE D'ARRESTO DETENT	1
KR8815	KIT PORTA RULLI ROLLERS HOLDING KIT	1

ELENCO RICAMBI FORNIBILI SINGOLARMENTE
LIST OF SPARE PARTS WHICH CAN BE SUPPLIED SEPARATELY

CODICE CODE	DESCRIZIONE DESCRIPTION	Q.TÀ QTY
F690/R7035	BRACCIO ORIENTABILE SWINGING ARM	2
F691/R7035	STAFFA BRACKET	1
F965/R7035	CARTER LATO CREMAGLIERA COVER-SPRING GROUP	1
F966/R7035	CARTER-MOLLA COVER-SPRING GROUP	1
H502	O-RING 3056 O-RING 3056	1
H704	O-RING 3037 O-RING 3037	1
I117	TAMBURO 300/350 DRUM 300/350	1
I122	CREMAGLIERA RACK	1
I166	BOCCOLA LATO MOLLA BUSH	1
I167	BOCCOLA LATO CREMAGLIERA BUSH	1
KG210	SNODO DESTRO M 3/8" RIGHTJOINT M 3/8"	1
KG272	SNODO DESTRO M 1/2" RIGHTJOINT M 1/2"	1
N083	MOLLA SPRING	1

ELENCO GUARNIZIONI SNODI
JOINTS GASKETS LIST

CODICE CODE	DESCRIZIONE DESCRIPTION	Q.TÀ QTY
H206	GUARNIZIONE OR 2093 VITON GASKET	2

tutti i diritti riservati - all rights reserved



Art. 8380.100 Mod. 380-20 bar - Art. 8380.300 Mod. 380-200 bar



VISTA ESPLOSA - EXPLODED VIEW

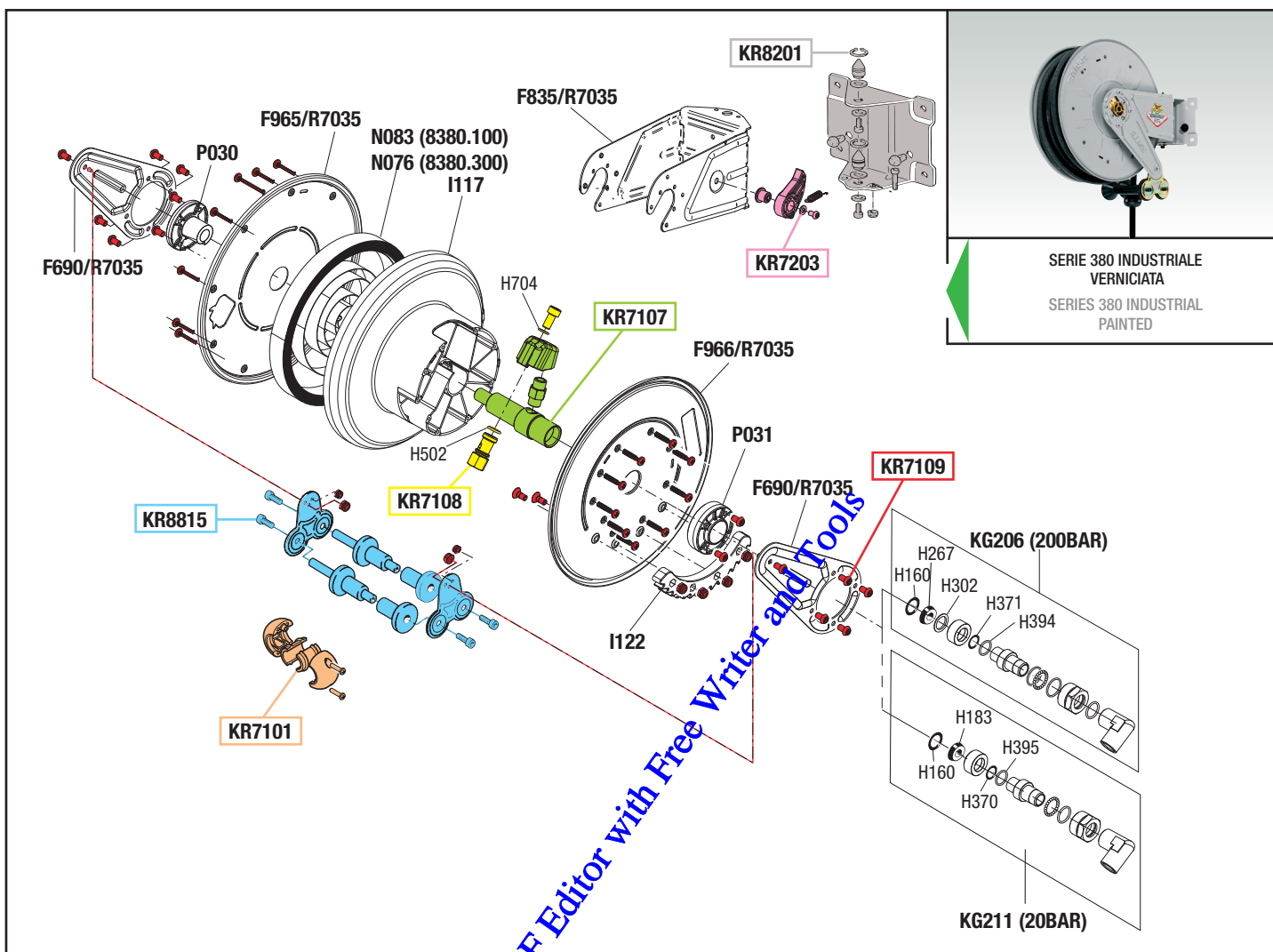

GUIDA RICAMBI - SPARE PARTS GUIDE

KIT RICAMBI
OGNI KIT SOTTO RIPORTATO COMPRENDE I RICAMBI EVIDENZIATI CON LO STESSO COLORE E LE RELATIVE GUARNIZIONI. QUESTI RICAMBI NON SONO FORNIBILI SEPARATAMENTE TRANNE QUELLI CODIFICATI.

SPARE PARTS KITS
EACH KIT SHOWN WITH THE SAME COLOR INCLUDES ALSO THE GASKETS. THE SPARE PARTS INCLUDED IN THE KIT CAN'T BE SUPPLIED SEPARATELY EXCEPT THOSE SHOWN WITH A PROPER CODE.

CODICE CODE	DESCRIZIONE DESCRIPTION	Q.TÀ QTY
KR7101	TAMPONE FERMATUBO HOSE STOP	1
KR7107	PERNO CENTRALE CENTRAL PIVOT	1
KR7108	BULLONE PER ATTACCO RAPIDO BOLT FOR QUICK CONNECTION	1
KR7109	SET VITI ARROTOLATORE SET OF SCREWS FOR HOSE REEL	1
KR7203	DENTE D'ARRESTO DETENT	1
KR8201	KIT STAFFA FISSA FIXED BACKET KIT	1
KR8815	KIT PORTA RULLI ROLLERS HOLDING KIT	1

ELENCO RICAMBI FORNIBILI SINGOLARMENTE
LIST OF SPARE PARTS WHICH CAN BE SUPPLIED SEPARATELY

CODICE CODE	DESCRIZIONE DESCRIPTION	Q.TÀ QTY
F690/R7035	BRACCIO ORIENTABILE SWINGING ARM	2
F835/R7035	STAFFA BRACKET	1
F965/R7035	CARTER-MOLLA COVER-SPRING GROUP	1
F966/R7035	CARTER LATO CREMAGLIERA COVER-SPRING GROUP	1
H502	O-RING 3056 "VITON" O-RING 3056 "VITON"	1
H704	O-RING 3037 "VITON" O-RING 3037 "VITON"	1
I117	TAMBURO 300/350 DRUM 300/350	1
I122	CREMAGLIERA RACK	1
KG206	SNODO ACQUA 200 BAR JOINT WATER 200 BAR	1
KG211	SNODO ARIA-ACQUA 20 BAR JOINT AIR-WATER 20 BAR	1
N076	MOLLA (8380.300) SPRING (8380.300)	1
N083	MOLLA (8380.100) SPRING (8380.100)	1
P030	BOCCOLA LATO MOLLA BUSH	1
P031	BOCCOLA LATO CREMAGLIERA BUSH	1

ELENCO GUARNIZIONI SNODI
JOINTS GASKETS LIST

CODICE CODE	DESCRIZIONE DESCRIPTION	Q.TÀ QTY
H160	O-RING 2093 O-RING 2093	1
H183	GUARNIZIONE GASKET	1
H267	GUARNIZIONE VITON GASKET VITON	1
H302	RONDELLA IN PTFE PTFE WASHER	1
H370	GUARNIZIONE OR. 2062 VITON GASKET	1
H371	GUARNIZIONE OR. 2037 VITON GASKET	1
H394	RONDELLA IN PTFE PTFE GASKET	1
H395	RONDELLA IN PTFE PTFE GASKET	1

tutti i diritti riservati - all rights reserved



Art. 8380.200 Mod. 380-100 bar - Art. 8380.400 Mod. 380-150 bar



VISTA ESPLOSA - EXPLODED VIEW

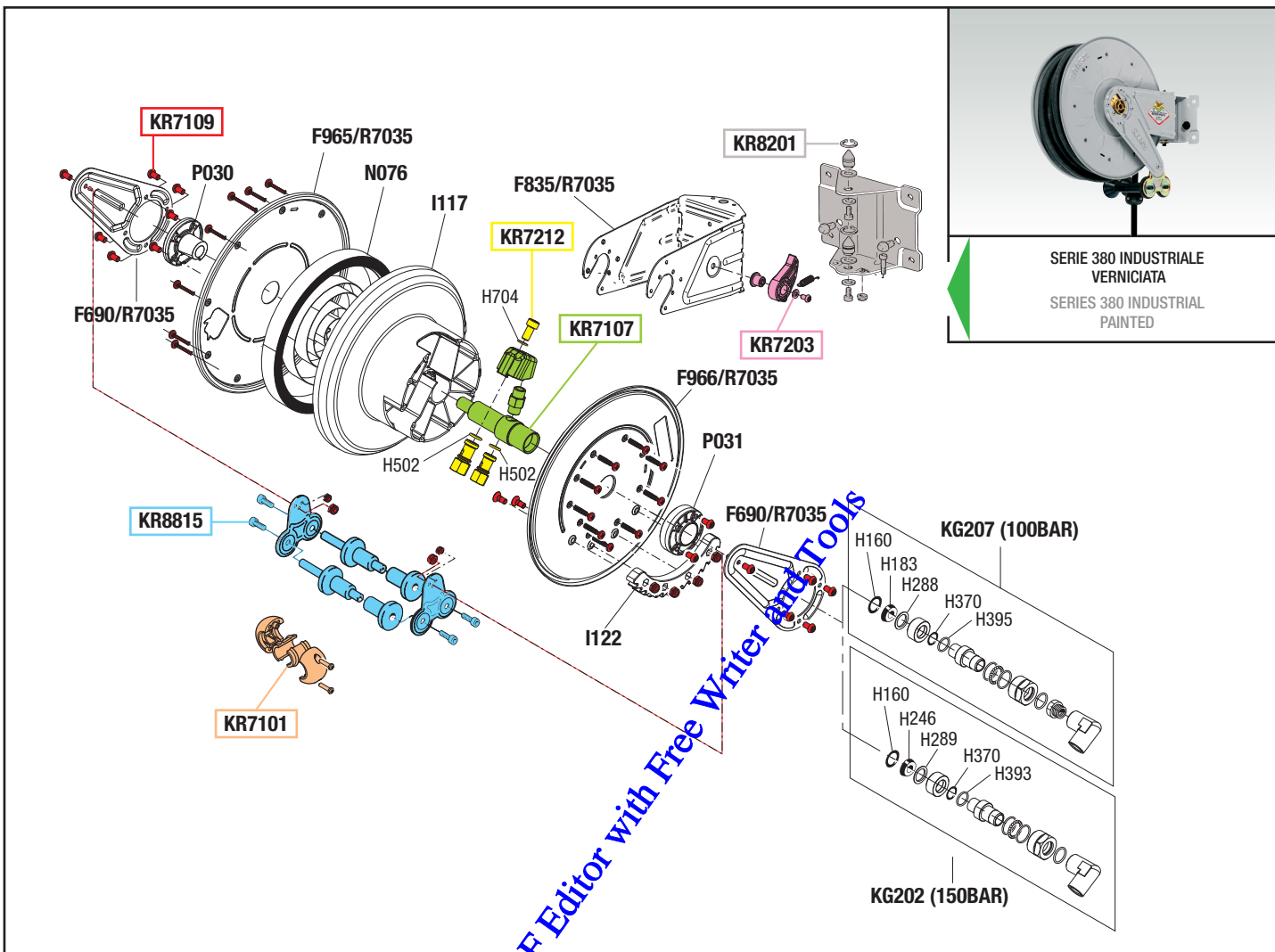

GUIDA RICAMBI - SPARE PARTS GUIDE

KIT RICAMBI
OGNI KIT SOTTO RIPORTATO COMPRENDE I RICAMBI EVIDENZIATI CON LO STESSO COLORE E LE RELATIVE GUARNIZIONI. QUESTI RICAMBI NON SONO FORNIBILI SEPARATAMENTE TRANNE QUELLI CODIFICATI.

SPARE PARTS KITS
EACH KIT SHOWN WITH THE SAME COLOR INCLUDES ALSO THE GASKETS. THE SPARE PARTS INCLUDED IN THE KIT CAN'T BE SUPPLIED SEPARATELY EXCEPT THOSE SHOWN WITH A PROPER CODE.

CODICE CODE	DESCRIZIONE DESCRIPTION	Q.TÀ QTY
KR7101	TAMPONE FERMATUBO HOSE STOP	1
KR7107	PERNO CENTRALE CENTRAL PIVOT	1
KR7109	SET VITI ARROTOLATORE SET OF SCREWS FOR HOSEREEL	1
KR7203	DENTE D'ARRESTO DETENT	1
KR7212	BULLONE PER ATTACCO RAPIDO BOLT FOR QUICK CONNECTION	1
KR8201	KIT STAFFA FISSA FIXED BACKET KIT	1
KR8815	KIT PORTA RULLI ROLLERS HOLDING KIT	1

ELENCO RICAMBI FORNIBILI SINGOLARMENTE
LIST OF SPARE PARTS WHICH CAN BE SUPPLIED SEPARATELY

CODICE CODE	DESCRIZIONE DESCRIPTION	Q.TÀ QTY
F690/R7035	BRACCIO ORIENTABILE SWINGING ARM	2
F835/R7035	STAFFA BRACKET	1
F965/R7035	CARTER-MOLLA COVER-SPRING GROUP	1
F966/R7035	CARTER LATO CREMAGLIERA COVER-SPRING GROUP	1
H502	O-RING 3056 "VITON" O-RING 3056 "VITON"	2
H704	O-RING 3037 "VITON" O-RING 3037 "VITON"	1
I117	TAMBURO 300/350 DRUM 300/350	1
I122	CREMAGLIERA RACK	1
KG202	SNODO OLIO 150 BAR JOINT OIL 150 BAR	1
KG207	SNODO ACQUA 100 BAR JOINT WATER 100 BAR	1
N076	MOLLA SPRING	1
P030	BOCCOLA LATO MOLLA BUSH	1
P031	BOCCOLA LATO CREMAGLIERA BUSH	1

ELENCO GUARNIZIONI SNODI
JOINTS GASKETS LIST

CODICE CODE	DESCRIZIONE DESCRIPTION	Q.TÀ QTY
H160	O-RING 2093 O-RING 2093	1
H183	GUARNIZIONE GASKET	1
H246	GUARN. MAD 2060/2-PUR 95 GASKET	1
H288	RONDELLA IN PTFE PTFE GASKET	1
H289	RONDELLA IN PTFE PTFE GASKET	1
H370	GUARNIZIONE OR. 2062 VITON GASKET	1
H393	RONDELLA IN PTFE PTFE GASKET	1
H395	RONDELLA IN PTFE PTFE GASKET	1

tutti i diritti riservati - all rights reserved



Art. 8380.350 Mod. 380-400 bar



VISTA ESPLOSA - EXPLODED VIEW

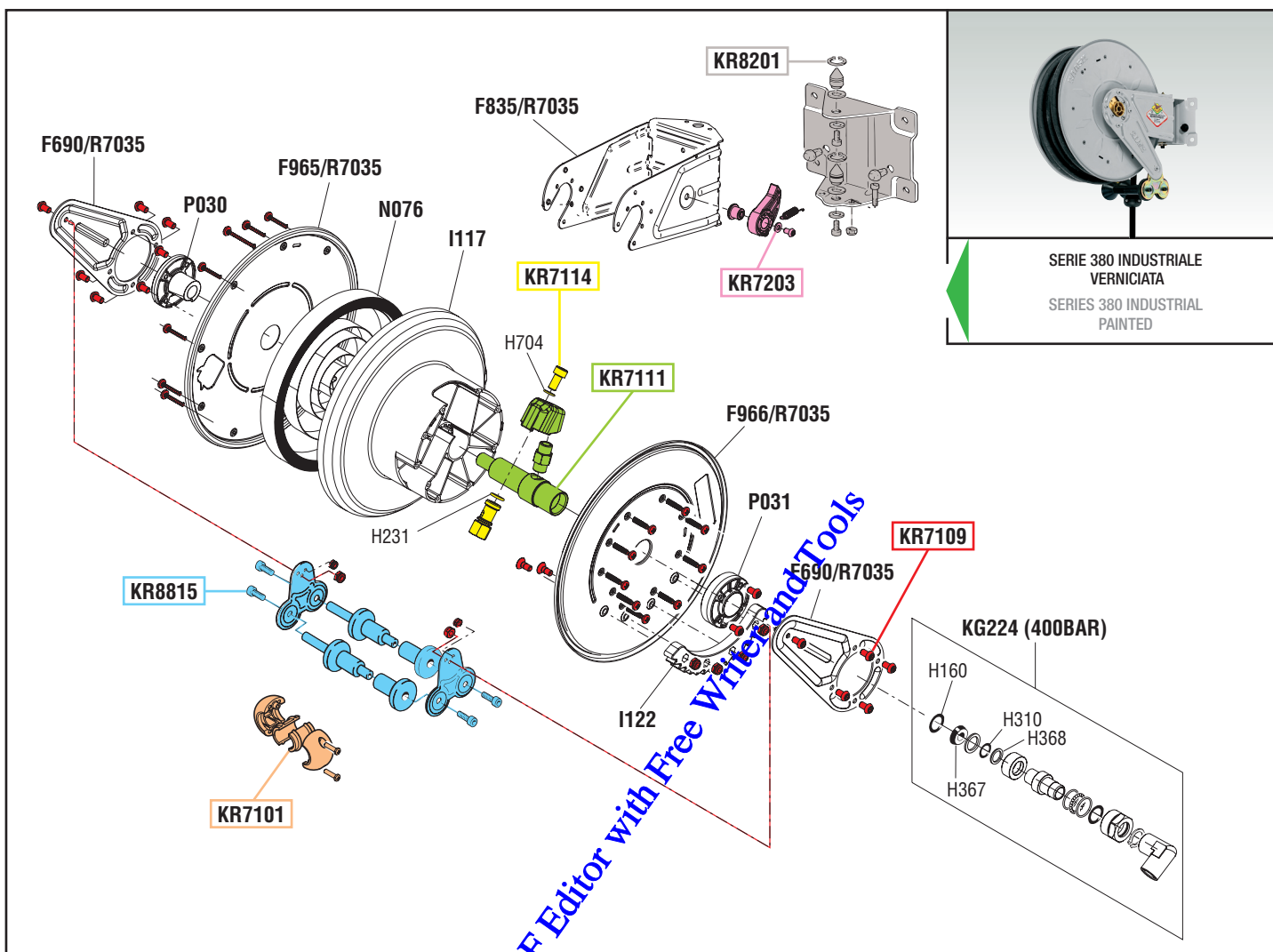

GUIDA RICAMBI - SPARE PARTS GUIDE

KIT RICAMBI
OGNI KIT SOTTO RIPORTATO COMPRENDE I RICAMBI EVIDENZIATI CON LO STESSO COLORE E LE RELATIVE GUARNIZIONI. QUESTI RICAMBI NON SONO FORNIBILI SEPARATAMENTE TRANNE QUELLI CODIFICATI.

SPARE PARTS KITS
EACH KIT SHOWN WITH THE SAME COLOR INCLUDES ALSO THE GASKETS. THE SPARE PARTS INCLUDED IN THE KIT CAN'T BE SUPPLIED SEPARATELY EXCEPT THOSE SHOWN WITH A PROPER CODE.

CODICE CODE	DESCRIZIONE DESCRIPTION	Q.TÀ QTY
KR7101	TAMPONE FERMATUBO HOSE STOP	1
KR7109	SET VITI ARROTOLATORE SET OF SCREWS FOR HOSE REEL	1
KR7111	PERNO CENTRALE CENTRAL PIVOT	1
KR7114	BULLONE PER ATTACCO RAPIDO BOLT FOR QUICK CONNECTION	1
KR7203	DENTE D'ARRESTO DETENT	1
KR8201	KIT STAFFA FISSA FIXED BACKET KIT	1
KR8815	KIT PORTA RULLI ROLLERS HOLDING KIT	1

ELENCO RICAMBI FORNIBILI SINGOLARMENTE
LIST OF SPARE PARTS WHICH CAN BE SUPPLIED SEPARATELY

CODICE CODE	DESCRIZIONE DESCRIPTION	Q.TÀ QTY
F690/R7035	BRACCIO ORIENTABILE SWINGING ARM	2
F835/R7035	STAFFA BRACKET	1
F965/R7035	CARTER-MOLLA COVER-SPRING GROUP	1
F966/R7035	CARTER LATO CREMAGLIERA COVER-SPRING GROUP	1
H231	O-RING 2056 "VITON" O-RING 2056 "VITON"	1
H704	O-RING 3037 "VITON" O-RING 3037 "VITON"	1
I117	TAMBURO 300/350 DRUM 300/350	1
I122	CREMAGLIERA RACK	1
KG224	SNODO ACQUA 400 BAR JOINT WATER 400 BAR	1
N076	MOLLA SPRING	1
P030	BOCCOLA LATO MOLLA BUSH	1
P031	BOCCOLA LATO CREMAGLIERA BUSH	1

ELENCO GUARNIZIONI SNODI
JOINTS GASKETS LIST

CODICE CODE	DESCRIZIONE DESCRIPTION	Q.TÀ QTY
H160	O-RING 2093 O-RING 2093	1
H310	O-RING 112 VITON O-RING 112 VITON	1
H367	GUARNIZIONE GASKET	1
H368	RONDELLA IN PTFE PTFE WASHER	1

tutti i diritti riservati - all rights reserved



Art. 8380.500 Mod. 380-600 bar



VISTA ESPLOSA - EXPLODED VIEW

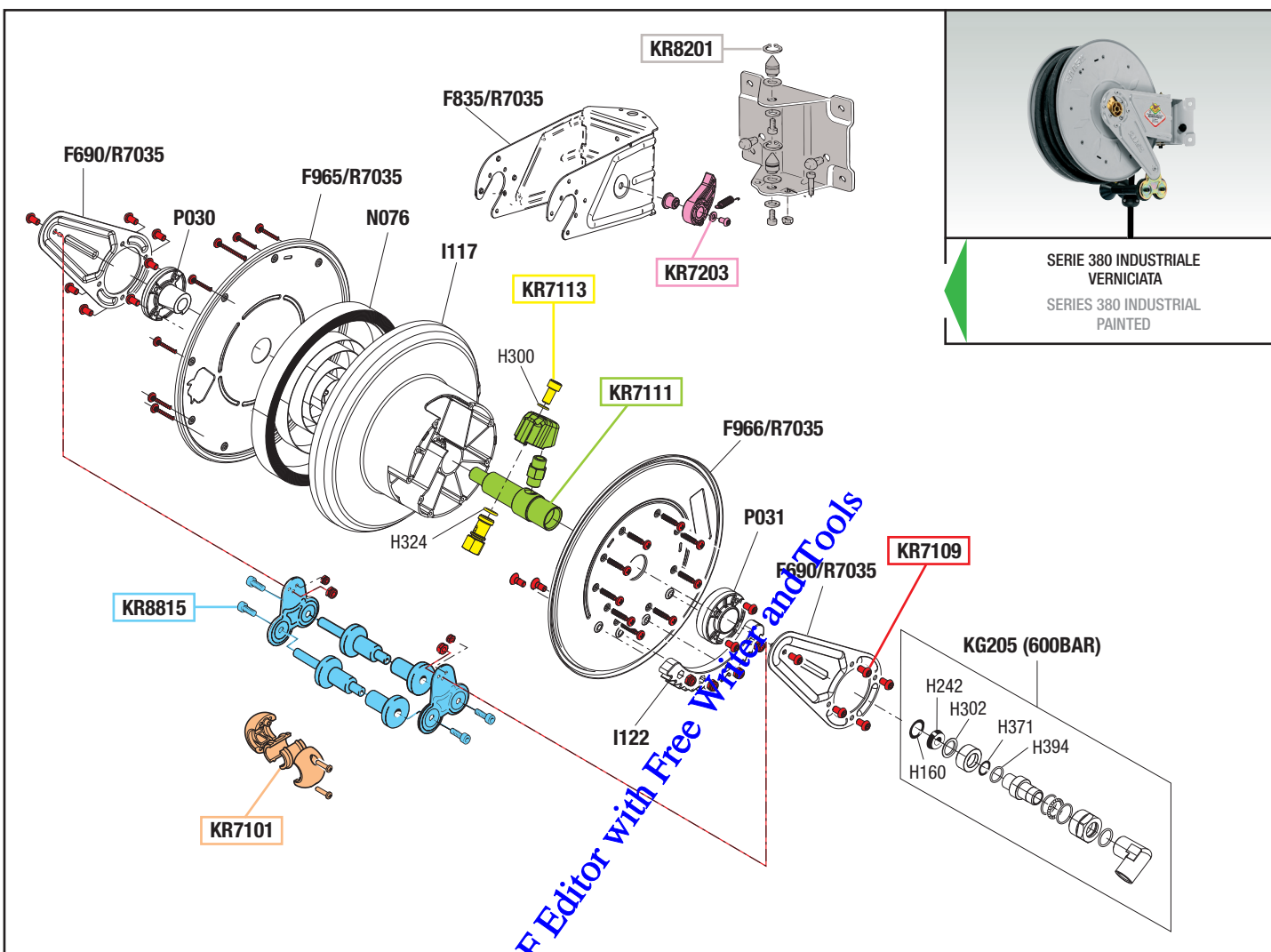

tutti i diritti riservati - all rights reserved

GUIDA RICAMBI - SPARE PARTS GUIDE

KIT RICAMBI
OGNI KIT SOTTO RIPORTATO COMPRENDE I RICAMBI EVIDENZIATI CON LO STESSO COLORE E LE RELATIVE GUARNIZIONI. QUESTI RICAMBI NON SONO FORNIBILI SEPARATAMENTE TRANNE QUELLI CODIFICATI.

SPARE PARTS KITS
EACH KIT SHOWN WITH THE SAME COLOR INCLUDES ALSO THE GASKETS. THE SPARE PARTS INCLUDED IN THE KIT CAN'T BE SUPPLIED SEPARATELY EXCEPT THOSE SHOWN WITH A PROPER CODE.

CODICE CODE	DESCRIZIONE DESCRIPTION	Q.TÀ QTY
KR7101	TAMPONE FERMATUBO HOSE STOP	1
KR7109	SET VITI ARROTOLATORE SET OF SCREWS FOR HOSEREEL	1
KR7111	PERNO CENTRALE CENTRAL PIVOT	1
KR7113	BULLONE PER ATTACCO RAPIDO BOLT FOR QUICK CONNECTION	1
KR7203	DENTE D'ARRESTO DETENT	1
KR8201	KIT STAFFA FISSA FIXED BRACKET KIT	1
KR8815	KIT PORTA RULLI ROLLERS HOLDING KIT	1

ELENCO RICAMBI FORNIBILI SINGOLARMENTE
LIST OF SPARE PARTS WHICH CAN BE SUPPLIED SEPARATELY

CODICE CODE	DESCRIZIONE DESCRIPTION	Q.TÀ QTY
F690/R7035	BRACCIO ORIENTABILE SWINGING ARM	2
F835/R7035	STAFFA BRACKET	1
F965/R7035	CARTER-MOLLA COVER-SPRING GROUP	1
F966/R7035	CARTER LATO CREMAGLIERA COVER-SPRING GROUP	1
H300	O-RING 3037 O-RING 3037	1
H324	O-RING 2056 O-RING 2056	1
I117	TAMBURO 300/350 DRUM 300/350	1
I122	CREMAGLIERA RACK	1
KG205	SNODO GRASSO 600 BAR JOINT GREASE 600 BAR	1
N076	MOLLA SPRING	1
P030	BOCCOLA LATO MOLLA BUSH	1
P031	BOCCOLA LATO CREMAGLIERA BUSH	1

ELENCO GUARNIZIONI SNODI
JOINTS GASKETS LIST

CODICE CODE	DESCRIZIONE DESCRIPTION	Q.TÀ QTY
H160	O-RING 2093 O-RING 2093	1
H242	GUARNIZIONE IM41810-PUR 95 GASKET	1
H302	RONDELLA IN PTFE PTFE WASHER	1
H371	GUARN. OR 2037VITON GASKET VITON	1
H394	RONDELLA IN PTFE PTFE WASHER	1



Art. 8382.100 Mod. 382-20 bar - Art. 8382.300 Mod. 382-200 bar



VISTA ESPLOSA - EXPLODED VIEW

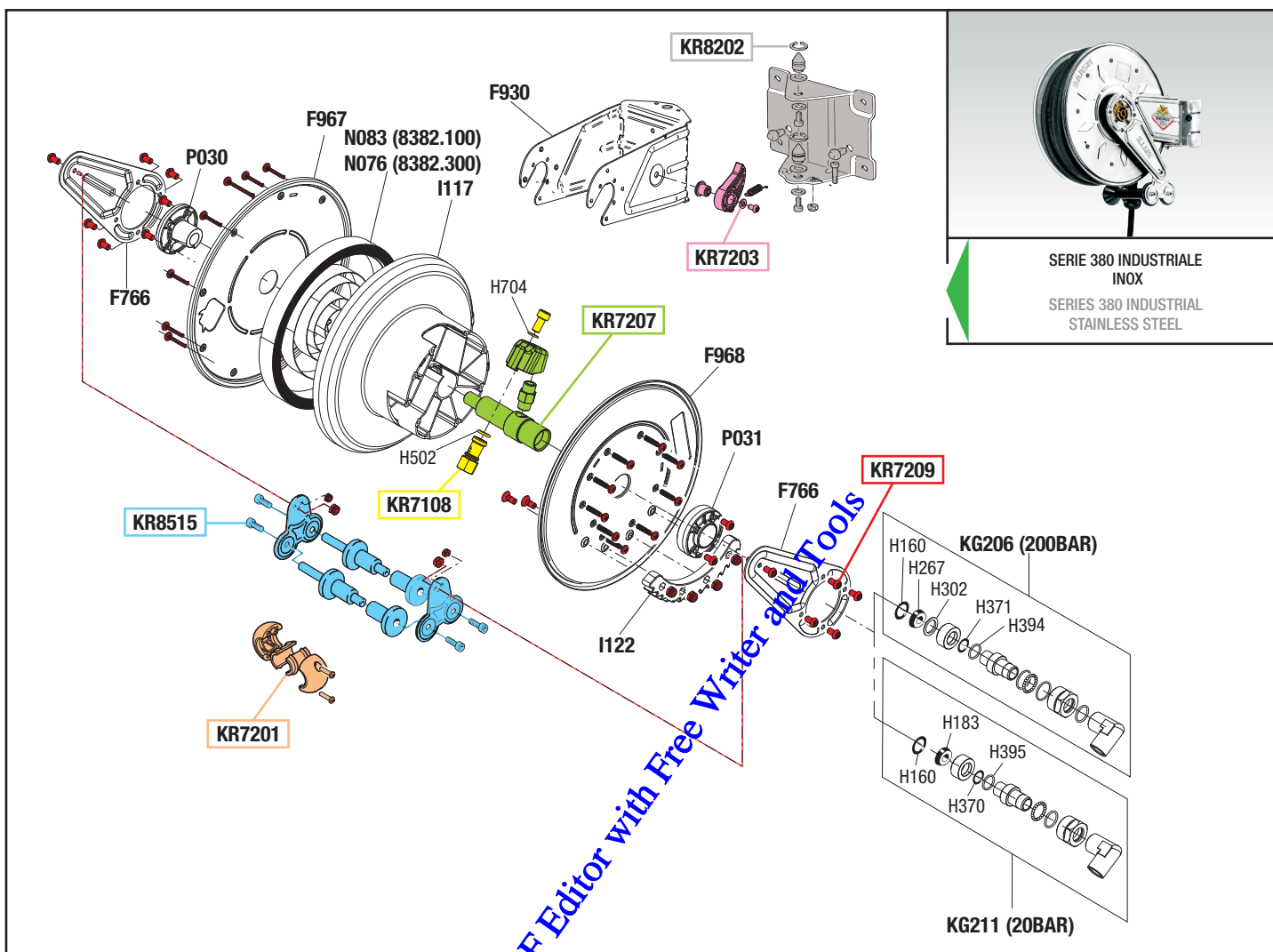

GUIDA RICAMBI - SPARE PARTS GUIDE

KIT RICAMBI
OGNI KIT SOTTO RIPORTATO COMPRENDE I RICAMBI EVIDENZIATI CON LO STESSO COLORE E LE RELATIVE GUARNIZIONI. QUESTI RICAMBI NON SONO FORNIBILI SEPARATAMENTE TRANNE QUELLI CODIFICATI.

SPARE PARTS KITS
EACH KIT SHOWN WITH THE SAME COLOR INCLUDES ALSO THE GASKETS. THE SPARE PARTS INCLUDED IN THE KIT CAN'T BE SUPPLIED SEPARATELY EXCEPT THOSE SHOWN WITH A PROPER CODE.

CODICE CODE	DESCRIZIONE DESCRIPTION	Q.TÀ QTY
KR7108	BULLONE PER ATTACCO RAPIDO BOLT FOR QUICK CONNECTION	1
KR7201	TAMPONE FERMATUBO HOSE STOP	1
KR7203	DENTE D'ARRESTO DETENT	1
KR7207	PERNO CENTRALE CENTRAL PIVOT	1
KR7209	SET VITI ARROTOLATORE SET OF SCREWS FOR HOSE REEL	1
KR8202	KIT STAFFA FISSA FIXED BACKET KIT	1
KR8515	KIT PORTA RULLI ROLLERS HOLDING KIT	1

ELENCO RICAMBI FORNIBILI SINGOLARMENTE
LIST OF SPARE PARTS WHICH CAN BE SUPPLIED SEPARATELY

CODICE CODE	DESCRIZIONE DESCRIPTION	Q.TÀ QTY
F766	BRACCIO ORIENTABILE SWINGING ARM	2
F930	STAFFA BRACKET	1
F967	CARTER-MOLLA COVER-SPRING GROUP	1
F968	CARTER LATO CREMAGLIERA COVER-SPRING GROUP	1
H502	O-RING 3056 "VITON" O-RING 3056 "VITON"	1
H704	O-RING 3037 "VITON" O-RING 3037 "VITON"	1
I117	TAMBURO 300/350 DRUM 300/350	1
I122	CREMAGLIERA RACK	1
KG206	SNODO ACQUA 200 BAR JOINT WATER 200 BAR	1
KG211	SNODO ARIA-ACQUA 20 BAR JOINT AIR-WATER 20 BAR	1
N076	MOLLA (8382.300) SPRING (8382.300)	1
N083	MOLLA (8382.100) SPRING (8382.100)	1
P030	BOCCOLA LATO MOLLA BUSH	1
P031	BOCCOLA LATO CREMAGLIERA BUSH	1

ELENCO GUARNIZIONI SNODI
JOINTS GASKETS LIST

CODICE CODE	DESCRIZIONE DESCRIPTION	Q.TÀ QTY
H160	O-RING 2093 O-RING 2093	1
H183	GUARNIZIONE GASKET	1
H267	GUARNIZIONE VITON GASKET VITON	1
H302	RONDELLA IN PTFE PTFE WASHER	1
H370	GUARNIZIONE OR. 2062 VITON GASKET	1
H371	GUARNIZIONE OR. 2037 VITON GASKET	1
H394	RONDELLA IN PTFE PTFE GASKET	1
H395	RONDELLA IN PTFE PTFE GASKET	1

tutti i diritti riservati - all rights reserved



Art. 8382.200 Mod. 382-100 bar



VISTA ESPLOSA - EXPLODED VIEW

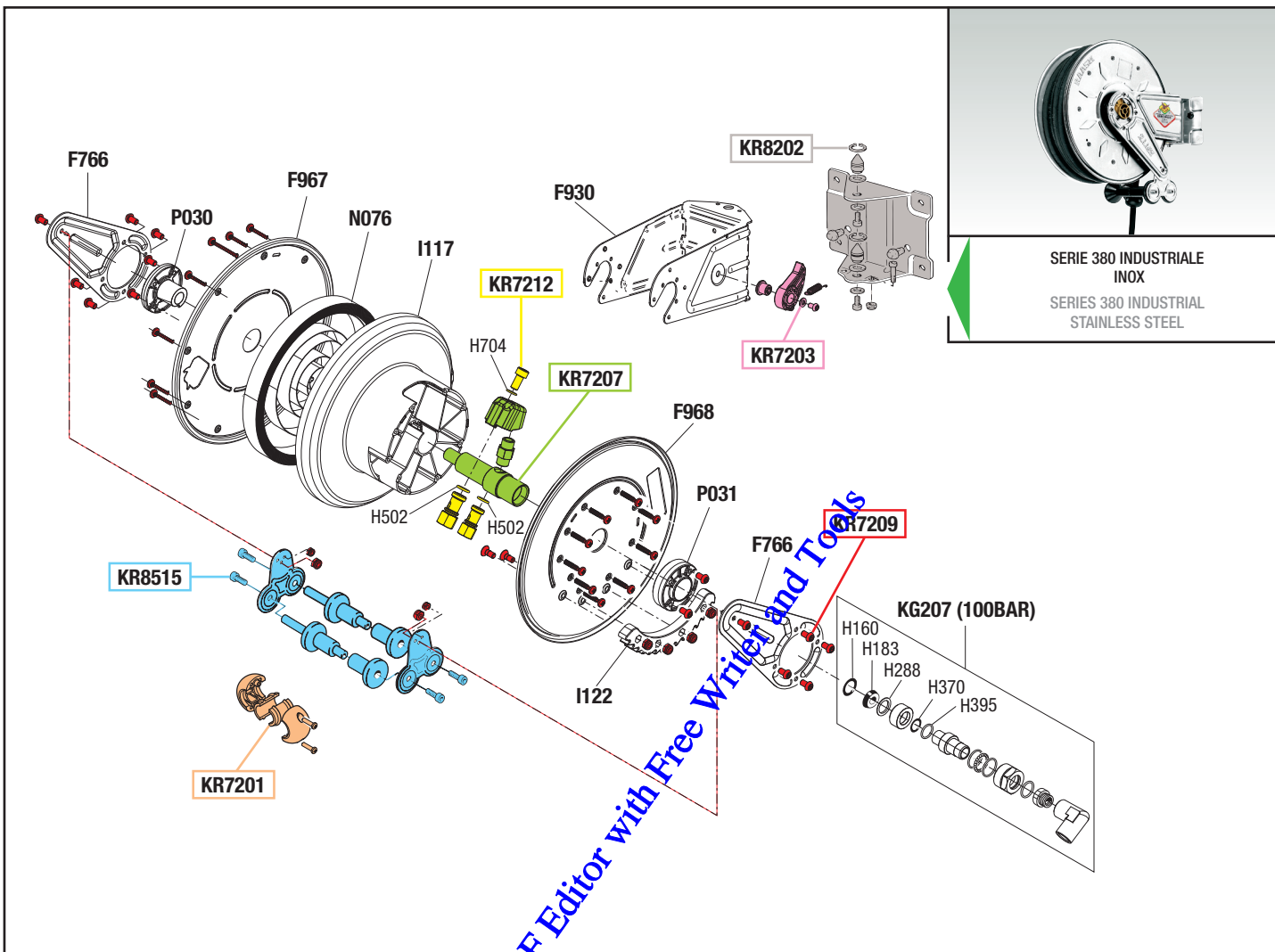

tutti i diritti riservati - all rights reserved

GUIDA RICAMBI - SPARE PARTS GUIDE

KIT RICAMBI
OGNI KIT SOTTO RIPORTATO COMPRENDE I RICAMBI EVIDENZIATI CON LO STESSO COLORE E LE RELATIVE GUARNIZIONI. QUESTI RICAMBI NON SONO FORNIBILI SEPARATAMENTE TRANNE QUELLI CODIFICATI.

SPARE PARTS KITS
EACH KIT SHOWN WITH THE SAME COLOR INCLUDES ALSO THE GASKETS. THE SPARE PARTS INCLUDED IN THE KIT CAN'T BE SUPPLIED SEPARATELY EXCEPT THOSE SHOWN WITH A PROPER CODE.

CODICE CODE	DESCRIZIONE DESCRIPTION	Q.TÀ QTY
KR7201	TAMPONE FERMATUBO HOSE STOP	1
KR7203	DENTE D'ARRESTO DETENT	1
KR7207	PERNO CENTRALE CENTRAL PIVOT	1
KR7209	SET VITI ARROTOLATORE SET OF SCREWS FOR HOSEREEL	1
KR7212	BULLONE PER ATTACCO RAPIDO BOLT FOR QUICK CONNECTION	1
KR8202	KIT STAFFA FISSA FIXED BRACKET KIT	1
KR8515	KIT PORTA RULLI ROLLERS HOLDING KIT	1

ELENCO RICAMBI FORNIBILI SINGOLARMENTE
LIST OF SPARE PARTS WHICH CAN BE SUPPLIED SEPARATELY

CODICE CODE	DESCRIZIONE DESCRIPTION	Q.TÀ QTY
F766	BRACCIO ORIENTABILE SWINGING ARM	2
F930	STAFFA BRACKET	1
F967	CARTER-MOLLA COVER-SPRING GROUP	1
F968	CARTER LATO CREMAGLIERA COVER-SPRING GROUP	1
H502	O-RING 3056 "VITON" O-RING 3056 "VITON"	2
H704	O-RING 3037 "VITON" O-RING 3037 "VITON"	1
I117	TAMBURO 300/350 DRUM 300/350	1
I122	CREMAGLIERA RACK	1
KG207	SNODO ACQUA 100 BAR JOINT WATER 100 BAR	1
N076	MOLLA SPRING	1
P030	BOCCOLA LATO MOLLA BUSH	1
P031	BOCCOLA LATO CREMAGLIERA BUSH	1

ELENCO GUARNIZIONI SNODI
JOINTS GASKETS LIST

CODICE CODE	DESCRIZIONE DESCRIPTION	Q.TÀ QTY
H160	O-RING 2093 O-RING 2093	1
H183	GUARNIZIONE GASKET	1
H288	RONDELLA IN PTFE PTFE GASKET	1
H370	O-RING 2062 VITON O-RING 2062 VITON	1
H395	RONDELLA IN PTFE PTFE GASKET	1



Art. 8382.350 Mod. 382-400 bar



VISTA ESPLOSA - EXPLODED VIEW

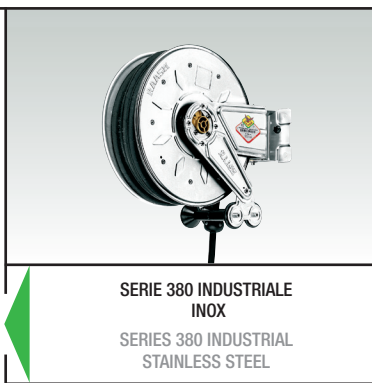
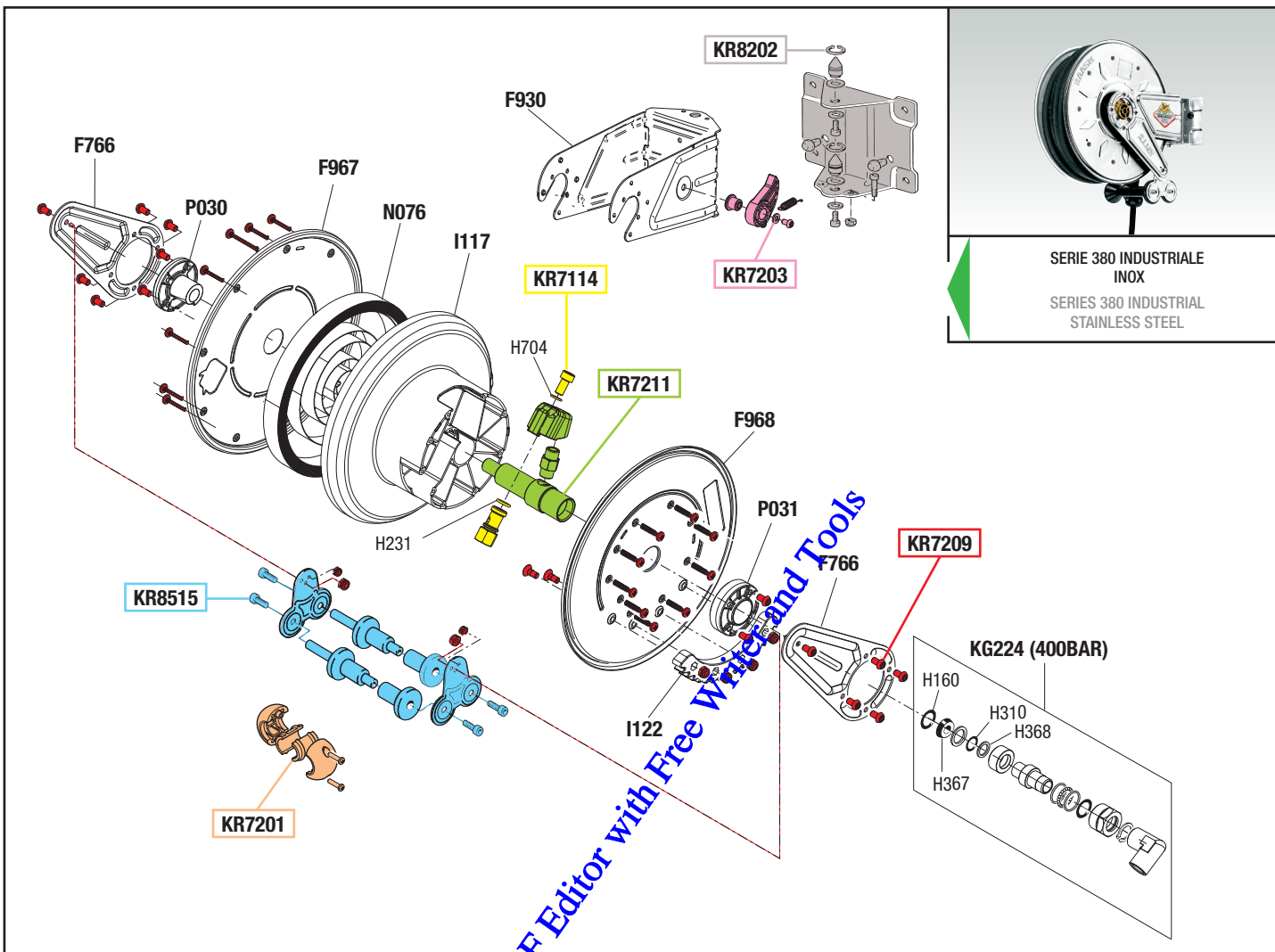

GUIDA RICAMBI - SPARE PARTS GUIDE

KIT RICAMBI
OGNI KIT SOTTO RIPORTATO COMPRENDE I RICAMBI EVIDENZIATI CON LO STESSO COLORE E LE RELATIVE GUARNIZIONI. QUESTI RICAMBI NON SONO FORNIBILI SEPARATAMENTE TRANNE QUELLI CODIFICATI.

SPARE PARTS KITS
EACH KIT SHOWN WITH THE SAME COLOR INCLUDES ALSO THE GASKETS. THE SPARE PARTS INCLUDED IN THE KIT CAN'T BE SUPPLIED SEPARATELY EXCEPT THOSE SHOWN WITH A PROPER CODE.

CODICE CODE	DESCRIZIONE DESCRIPTION	Q.TÀ QTY
KR7114	BULLONE PER ATTACCO RAPIDO BOLT FOR QUICK CONNECTION	1
KR7201	TAMPONE FERMATUBO HOSE STOP	1
KR7203	DENTE D'ARRESTO DETENT	1
KR7209	SET VITI ARROTOLATORE SET OF SCREWS FOR HOSEREEL	1
KR7211	PERNO CENTRALE CENTRAL PIVOT	1
KR8202	KIT STAFFA FISSA FIXED BACKET KIT	1
KR8515	KIT PORTA RULLI ROLLERS HOLDING KIT	1

ELENCO RICAMBI FORNIBILI SINGOLARMENTE
LIST OF SPARE PARTS WHICH CAN BE SUPPLIED SEPARATELY

CODICE CODE	DESCRIZIONE DESCRIPTION	Q.TÀ QTY
F766	BRACCIO ORIENTABILE SWINGING ARM	2
F930	STAFFA BRACKET	1
F967	CARTER-MOLLA COVER-SPRING GROUP	1
F968	CARTER LATO CREMAGLIERA COVER-SPRING GROUP	1
H231	O-RING 2056 "VITON" O-RING 2056 "VITON"	1
H704	O-RING 3037 "VITON" O-RING 3037 "VITON"	1
I117	TAMBURO 300/350 DRUM 300/350	1
I122	CREMAGLIERA RACK	1
KG224	SNODO ACQUA 400 BAR JOINT WATER 400 BAR	1
N076	MOLLA SPRING	1
P030	BOCCOLA LATO MOLLA BUSH	1
P031	BOCCOLA LATO CREMAGLIERA BUSH	1

ELENCO GUARNIZIONI SNODI
JOINTS GASKETS LIST

CODICE CODE	DESCRIZIONE DESCRIPTION	Q.TÀ QTY
H160	O-RING 2093 O-RING 2093	1
H310	O-RING 112 VITON O-RING 112 VITON	1
H367	GUARNIZIONE GASKET	1
H368	RONDELLA IN PTFE PTFE WASHER	1

tutti i diritti riservati - all rights reserved



Art. 8382.500 Mod. 382-600 bar



VISTA ESPLOSA - EXPLODED VIEW

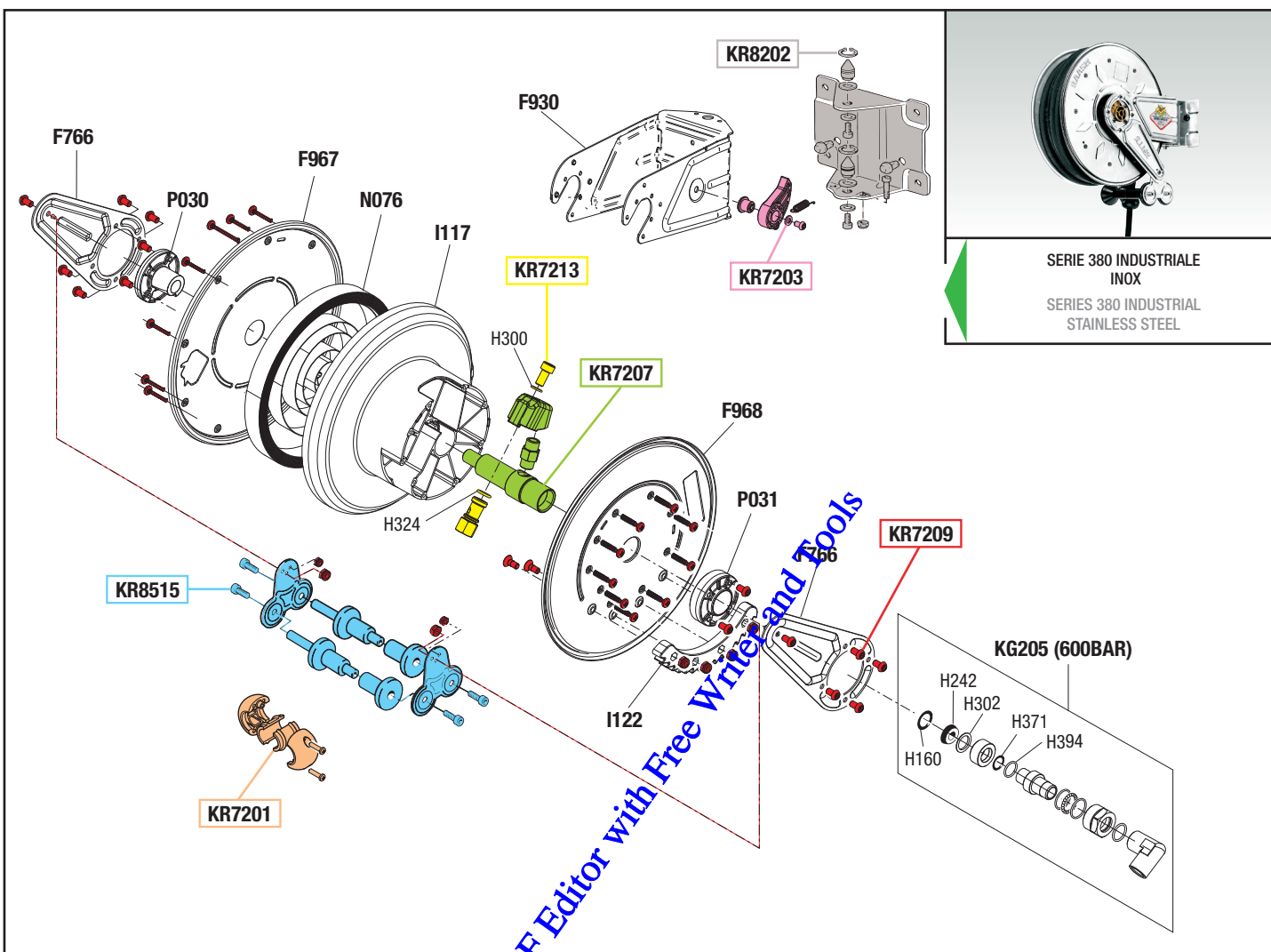

GUIDA RICAMBI - SPARE PARTS GUIDE

KIT RICAMBI
OGNI KIT SOTTO RIPORTATO COMPRENDE I RICAMBI EVIDENZIATI CON LO STESSO COLORE E LE RELATIVE GUARNIZIONI. QUESTI RICAMBI NON SONO FORNIBILI SEPARATAMENTE TRANNE QUELLI CODIFICATI.

SPARE PARTS KITS
EACH KIT SHOWN WITH THE SAME COLOR INCLUDES ALSO THE GASKETS. THE SPARE PARTS INCLUDED IN THE KIT CAN'T BE SUPPLIED SEPARATELY EXCEPT THOSE SHOWN WITH A PROPER CODE.

CODICE CODE	DESCRIZIONE DESCRIPTION	Q.TÀ QTY
KR7201	TAMPONE FERMATUBO HOSE STOP	1
KR7203	DENTE D'ARRESTO DETENT	1
KR7207	PERNO CENTRALE CENTRAL PIVOT	1
KR7209	SET VITI ARROTOLATORE SET OF SCREWS FOR HOSEREEL	1
KR7213	BULLONE PER ATTACCO RAPIDO BOLT FOR QUICK CONNECTION	1
KR8202	KIT STAFFA FISSA FIXED BRACKET KIT	1
KR8515	KIT PORTA RULLI ROLLERS HOLDING KIT	1

ELENCO RICAMBI FORNIBILI SINGOLARMENTE
LIST OF SPARE PARTS WHICH CAN BE SUPPLIED SEPARATELY

CODICE CODE	DESCRIZIONE DESCRIPTION	Q.TÀ QTY
F766	BRACCIO ORIENTABILE SWINGING ARM	2
F930	STAFFA BRACKET	1
F967	CARTER-MOLLA COVER-SPRING GROUP	1
F968	CARTER LATO CREMAGLIERA COVER-SPRING GROUP	1
H300	O-RING 3037 O-RING 3037	1
H324	O-RING 2056 O-RING 2056	1
I117	TAMBURO 300/350 DRUM 300/350	1
I122	CREMAGLIERA RACK	1
KG205	SNODO GRASSO 600 BAR JOINT GREASE 600 BAR	1
N076	MOLLA SPRING	1
P030	BOCCOLA LATO MOLLA BUSH	1
P031	BOCCOLA LATO CREMAGLIERA BUSH	1

ELENCO GUARNIZIONI SNODI
JOINTS GASKETS LIST

CODICE CODE	DESCRIZIONE DESCRIPTION	Q.TÀ QTY
H160	O-RING 2093 O-RING 2093	1
H242	GUARNIZIONE M41810-PUR 95 GASKET	1
H302	RONDELLA IN PTFE PTFE WASHER	1
H371	GUARN. OR 2037/VITON GASKET VITON	1
H394	RONDELLA IN PTFE PTFE WASHER	1

tutti i diritti riservati - all rights reserved



Art. 8390.100 Mod. 390-20 bar - Art. 8390.300 Mod. 390-200 bar



VISTA ESPLOSA - EXPLODED VIEW

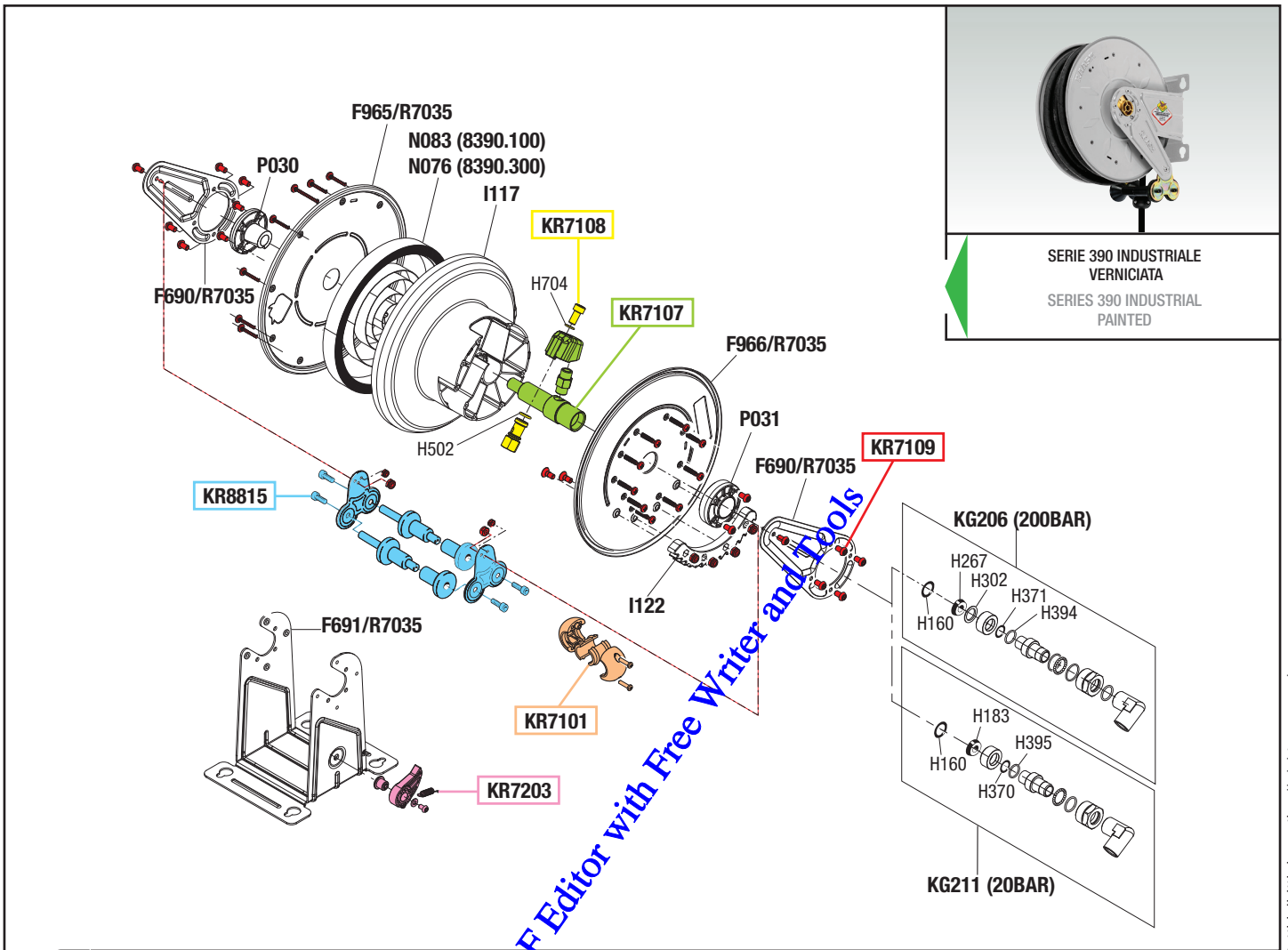

GUIDA RICAMBI - SPARE PARTS GUIDE

KIT RICAMBI
OGNI KIT SOTTO RIPORTATO COMPRENDE I RICAMBI EVIDENZIATI CON LO STESSO COLORE E LE RELATIVE GUARNIZIONI. QUESTI RICAMBI NON SONO FORNIBILI SEPARATAMENTE TRANNE QUELLI CODIFICATI.

SPARE PARTS KITS
EACH KIT SHOWN WITH THE SAME COLOR INCLUDES ALSO THE GASKETS. THE SPARE PARTS INCLUDED IN THE KIT CAN'T BE SUPPLIED SEPARATELY EXCEPT THOSE SHOWN WITH A PROPER CODE.

CODICE CODE	DESCRIZIONE DESCRIPTION	Q.TÀ QTY
KR7101	TAMPONE FERMATUBO HOSE STOP	1
KR7107	PERNO CENTRALE CENTRAL PIVOT	1
KR7108	BULLONE PER ATTACCO RAPIDO BOLT FOR QUICK CONNECTION	1
KR7109	SET VITI ARROTOLATORE SET OF SCREWS FOR HOSEREEL	1
KR7203	DENTE D'ARRESTO DETENT	1
KR8815	KIT PORTA RULLI ROLLERS HOLDING KIT	1

ELENCO RICAMBI FORNIBILI SINGOLARMENTE
LIST OF SPARE PARTS WHICH CAN BE SUPPLIED SEPARATELY

CODICE CODE	DESCRIZIONE DESCRIPTION	Q.TÀ QTY
F690/R7035	BRACCIO ORIENTABILE SWINGING ARM	2
F691/R7035	STAFFA BRACKET	1
F965/R7035	CARTER-MOLLA COVER-SPRING GROUP	1
F966/R7035	CARTER LATO CREMAGLIERA COVER-SPRING GROUP	1
H502	O-RING 3056 O-RING 3056	1
H704	O-RING 3037 O-RING 3037	1
I117	TAMBURO 300/350 DRUM 300/350	1
I122	CREMAGLIERA RACK	1
KG206	SNODO ACQUA 200 BAR JOINT WATER 200 BAR	1
KG211	SNODO ARIA-ACQUA 20 BAR JOINT AIR-WATER 20 BAR	1
N076	MOLLA (8390.300) SPRING (8390.300)	1
N083	MOLLA (8390.100) SPRING (8390.100)	1
P030	BOCCOLA LATO MOLLA BUSH	1
P031	BOCCOLA LATO CREMAGLIERA BUSH	1

ELENCO GUARNIZIONI SNODI
JOINTS GASKETS LIST

CODICE CODE	DESCRIZIONE DESCRIPTION	Q.TÀ QTY
H160	O-RING 2093 O-RING 2093	1
H183	GUARNIZIONE GASKET	1
H267	GUARNIZIONE VITON GASKET VITON	1
H302	RONDELLA IN PTFE PTFE WASHER	1
H370	O-RING 2062 VITON O-RING 2062 VITON	1
H371	O-RING 2037 VITON O-RING 2037 VITON	1
H394	RONDELLA IN PTFE PTFE GASKET	1
H395	RONDELLA IN PTFE PTFE GASKET	1

tutti i diritti riservati - all rights reserved



Art. 8390.200 Mod. 390-100 bar - Art. 8390.400 Mod. 390-150 bar



VISTA ESPLOSA - EXPLODED VIEW

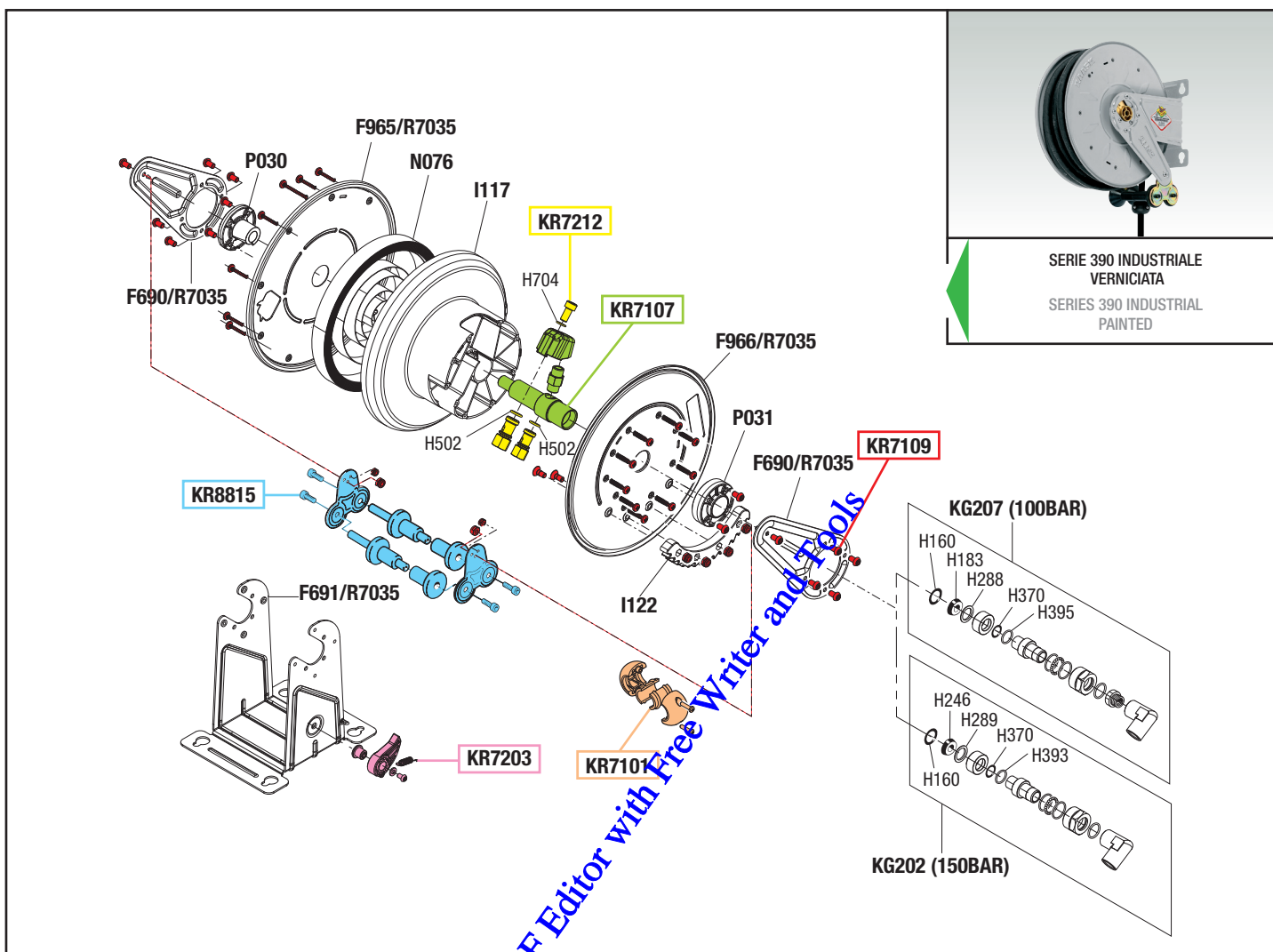

GUIDA RICAMBI - SPARE PARTS GUIDE

KIT RICAMBI
OGNI KIT SOTTO RIPORTATO COMPRENDE I RICAMBI EVIDENZIATI CON LO STESSO COLORE E LE RELATIVE GUARNIZIONI. QUESTI RICAMBI NON SONO FORNIBILI SEPARATAMENTE TRANNE QUELLI CODIFICATI.

SPARE PARTS KITS
EACH KIT SHOWN WITH THE SAME COLOR INCLUDES ALSO THE GASKETS. THE SPARE PARTS INCLUDED IN THE KIT CAN'T BE SUPPLIED SEPARATELY EXCEPT THOSE SHOWN WITH A PROPER CODE.

CODICE CODE	DESCRIZIONE DESCRIPTION	Q.TÀ QTY
KR7101	TAMPONE FERMATUBO HOSE STOP	1
KR7107	PERNO CENTRALE CENTRAL PIVOT	1
KR7109	SET VITI ARROTOLATORE SET OF SCREWS FOR HOSE REEL	1
KR7203	DENTE D'ARRESTO DETENT	1
KR7212	BULLONE PER ATTACCO RAPIDO BOLT FOR QUICK CONNECTION	1
KR8815	KIT PORTA RULLI ROLLERS HOLDING KIT	1

ELENCO RICAMBI FORNIBILI SINGOLARMENTE
LIST OF SPARE PARTS WHICH CAN BE SUPPLIED SEPARATELY

CODICE CODE	DESCRIZIONE DESCRIPTION	Q.TÀ QTY
F690/R7035	BRACCIO ORIENTABILE SWINGING ARM	2
F691/R7035	STAFFA BRACKET	1
F965/R7035	CARTER-MOLLA COVER-SPRING GROUP	1
F966/R7035	CARTER LATO CREMAGLIERA COVER-SPRING GROUP	1
H502	O-RING 3056 O-RING 3056	2
H704	O-RING 3037 O-RING 3037	1
I117	TAMBURO 300/350 DRUM 300/350	1
I122	CREMAGLIERA RACK	1
KG202	SNODO OLIO 150 BAR JOINT OIL 150 BAR	1
KG207	SNODO ACQUA 100 BAR JOINT WATER 100 BAR	1
N076	MOLLA SPRING	1
P030	BOCCOLA LATO MOLLA BUSH	1
P031	BOCCOLA LATO CREMAGLIERA BUSH	1

ELENCO GUARNIZIONI SNODI
JOINTS GASKETS LIST

CODICE CODE	DESCRIZIONE DESCRIPTION	Q.TÀ QTY
H160	O-RING 2093 O-RING 2093	1
H183	GUARNIZIONE GASKET	1
H246	GUARN. MAD 2060/2-PUR 95 GASKET	1
H288	RONDELLA IN PTFE PTFE GASKET	1
H289	RONDELLA IN PTFE PTFE GASKET	1
H370	O-RING 2062 VITON O-RING 2062 VITON	1
H393	RONDELLA IN PTFE PTFE GASKET	1
H395	RONDELLA IN PTFE PTFE GASKET	1

tutti i diritti riservati - all rights reserved



Art. 8390.350 Mod. 390-400 bar



VISTA ESPLOSA - EXPLODED VIEW

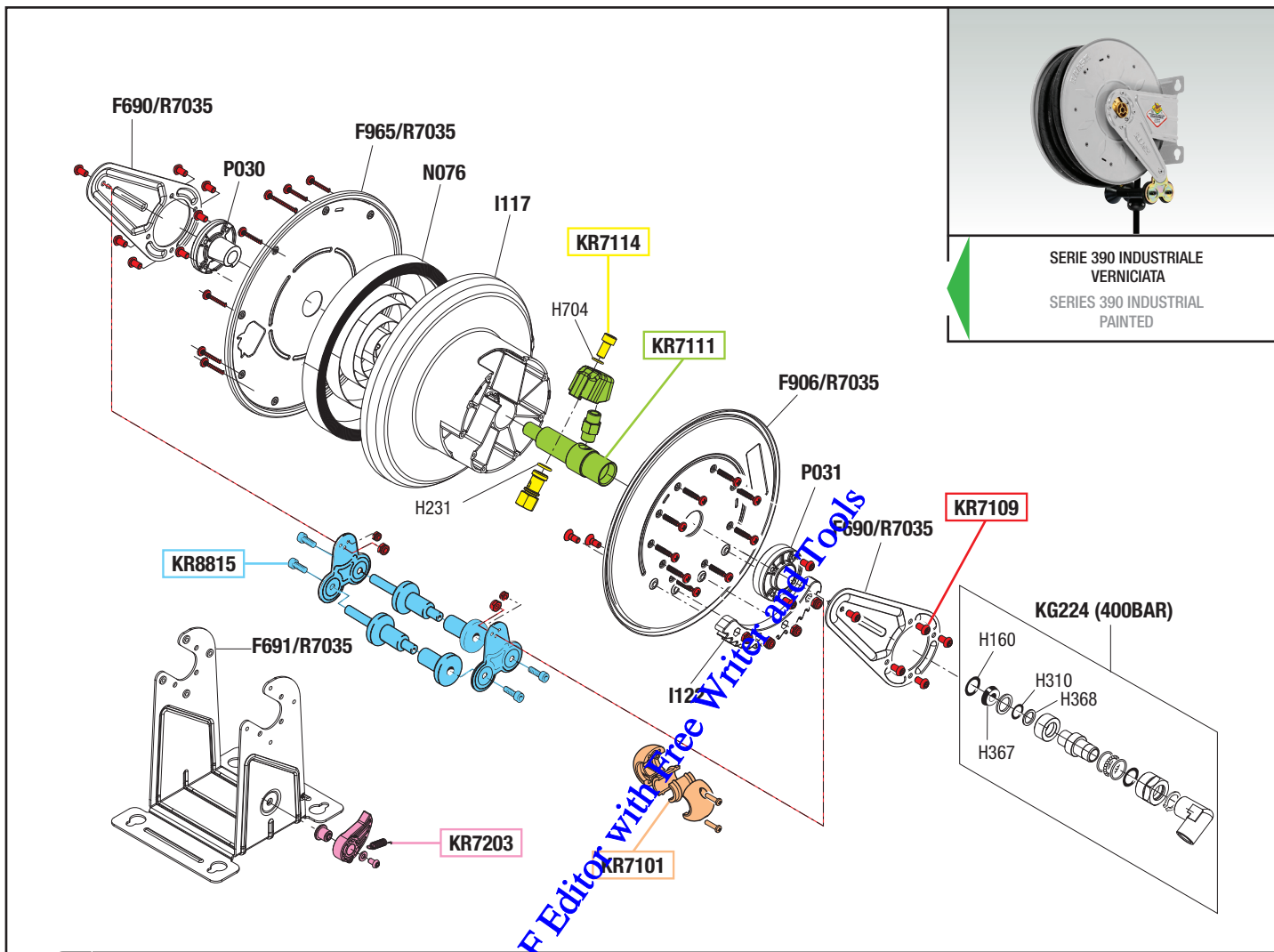

tutti i diritti riservati - all rights reserved

GUIDA RICAMBI - SPARE PARTS GUIDE

KIT RICAMBI
OGNI KIT SOTTO RIPIPORTATO COMPRENDE I RICAMBI EVIDENZIATI CON LO STESSO COLORE E LE RELATIVE GUARNIZIONI. QUESTI RICAMBI NON SONO FORNIBILI SEPARATAMENTE TRANNE QUELLI CODIFICATI.

SPARE PARTS KITS
EACH KIT SHOWN WITH THE SAME COLOR INCLUDES ALSO THE GASKETS. THE SPARE PARTS INCLUDED IN THE KIT CAN'T BE SUPPLIED SEPARATELY EXCEPT THOSE SHOWN WITH A PROPER CODE.

CODICE CODE	DESCRIZIONE DESCRIPTION	Q.TÀ QTY
KR7101	TAMPONE FERMATUBO HOSE STOP	1
KR7109	SET VITI ARROTOLATORE SET OF SCREWS FOR HOSEREEL	1
KR7111	PERNO CENTRALE CENTRAL PIVOT	1
KR7114	BULLONE PER ATTACCO RAPIDO BOLT FOR QUICK CONNECTION	1
KR7203	DENTE D'ARRESTO DETENT	1
KR8815	KIT PORTA RULLI ROLLERS HOLDING KIT	1

ELENCO RICAMBI FORNIBILI SINGOLARMENTE
LIST OF SPARE PARTS WHICH CAN BE SUPPLIED SEPARATELY

CODICE CODE	DESCRIZIONE DESCRIPTION	Q.TÀ QTY
F690/R7035	BRACCIO ORIENTABILE SWINGING ARM	2
F691/R7035	STAFFA BRACKET	1
F965/R7035	CARTER-MOLLA COVER-SPRING GROUP	1
F966/R7035	CARTER LATO CREMAGLIERA COVER-SPRING GROUP	1
H231	O-RING 3037 O-RING 3037	1
H704	O-RING 2056 O-RING 2056	1
I117	TAMBURO 300/350 DRUM 300/350	1
I122	CREMAGLIERA RACK	1
KG224	SNODO ACQUA 400 BAR JOINT WATER 400 BAR	1
N076	MOLLA SPRING	1
P030	BOCCOLA LATO MOLLA BUSH	1
P031	BOCCOLA LATO CREMAGLIERA BUSH	1

ELENCO GUARNIZIONI SNODI
JOINTS GASKETS LIST

CODICE CODE	DESCRIZIONE DESCRIPTION	Q.TÀ QTY
H160	O-RING 2093 O-RING 2093	1
H310	O-RING 112 VITON O-RING 112 VITON	1
H367	GUARNIZIONE GASKET	1
H368	RONDELLA IN PTFE PTFE WASHER	1



Art. 8390.500 Mod. 390-600 bar



VISTA ESPLOSA - EXPLODED VIEW

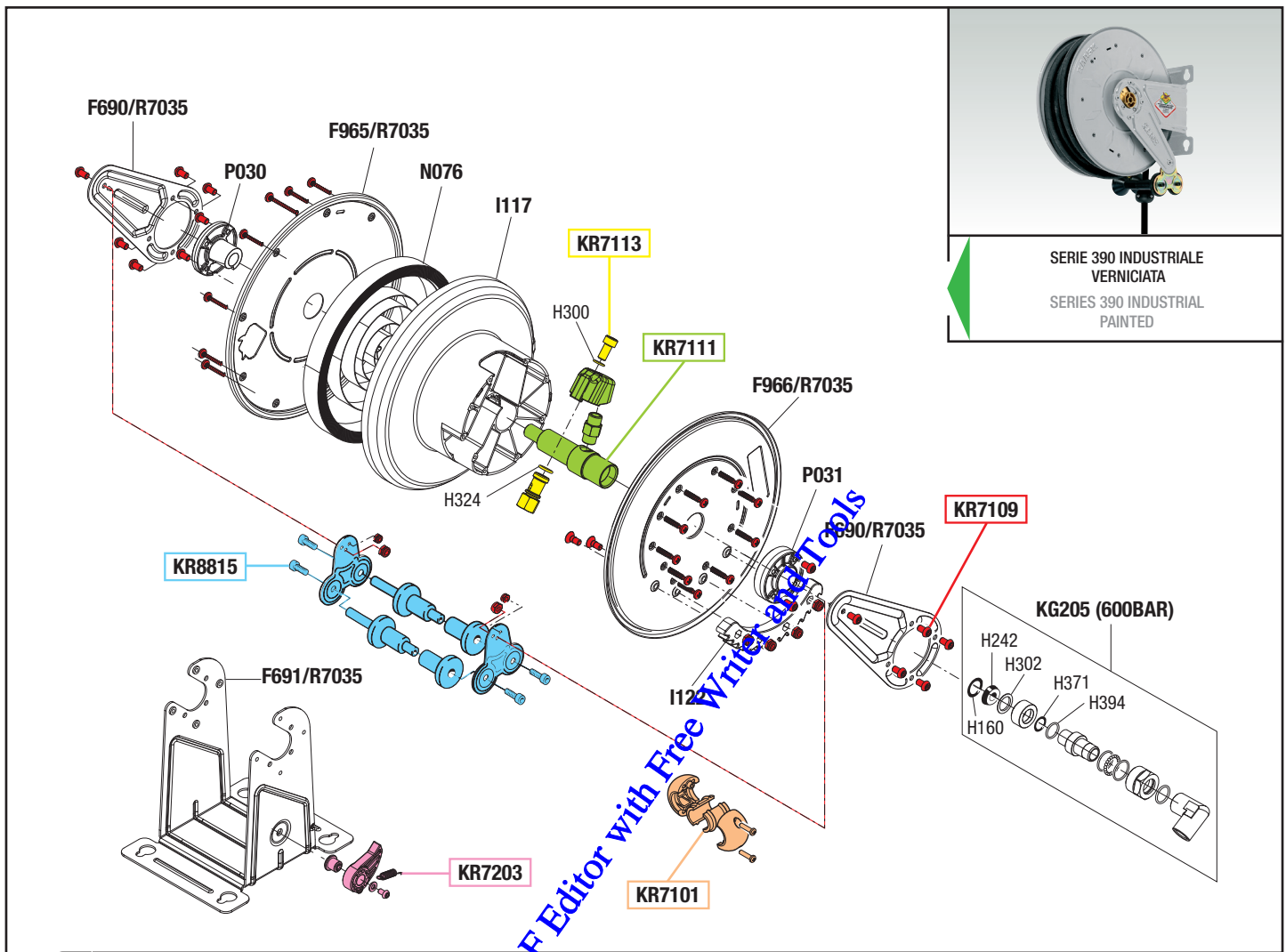

tutti i diritti riservati - all rights reserved

GUIDA RICAMBI - SPARE PARTS GUIDE

KIT RICAMBI

OGNI KIT SOTTO RIPORTATO COMPRENDE I RICAMBI EVIDENZIATI CON LO STESSO COLORE E LE RELATIVE GUARNIZIONI. QUESTI RICAMBI NON SONO FORNIBILI SEPARATAMENTE TRANNE QUELLI CODIFICATI.

SPARE PARTS KITS

EACH KIT SHOWN WITH THE SAME COLOR INCLUDES ALSO THE GASKETS. THE SPARE PARTS INCLUDED IN THE KIT CAN'T BE SUPPLIED SEPARATELY EXCEPT THOSE SHOWN WITH A PROPER CODE.

CODICE CODE	DESCRIZIONE DESCRIPTION	Q.TÀ QTY
KR7101	TAMPONE FERMATUBO HOSE STOP	1
KR7109	SET VITI ARROTOLATORE SET OF SCREWS FOR HOSE REEL	1
KR7111	PERNO CENTRALE CENTRAL PIVOT	1
KR7113	BULLONE PER ATTACCO RAPIDO BOLT FOR QUICK CONNECTION	1
KR7203	DENTE D'ARRESTO DETENT	1
KR8815	KIT PORTA RULLI ROLLERS HOLDING KIT	1

ELENCO RICAMBI FORNIBILI SINGOLARMENTE

LIST OF SPARE PARTS WHICH CAN BE SUPPLIED SEPARATELY

CODICE CODE	DESCRIZIONE DESCRIPTION	Q.TÀ QTY
F690/R7035	BRACCIO ORIENTABILE SWINGING ARM	2
F691/R7035	STAFFA BRACKET	1
F965/R7035	CARTER-MOLLA COVER-SPRING GROUP	1
F966/R7035	CARTER LATO CREMAGLIERA COVER-SPRING GROUP	1
H300	O-RING 3037 O-RING 3037	1
H324	O-RING 2056 O-RING 2056	1
I117	TAMBURO 300/350 DRUM 300/350	1
I122	CREMAGLIERA RACK	1
KG205	SNODO GRASSO 600 BAR JOINT GREASE 600 BAR	1
N076	MOLLA SPRING	1
P030	BOCCOLA LATO MOLLA BUSH	1
P031	BOCCOLA LATO CREMAGLIERA BUSH	1

ELENCO GUARNIZIONI SNODI

JOINTS GASKETS LIST

CODICE CODE	DESCRIZIONE DESCRIPTION	Q.TÀ QTY
H160	O-RING 2093 O-RING 2093	1
H242	GUARNIZIONE IM41810-PUR 95 GASKET	1
H302	RONDELLA IN PTFE PTFE WASHER	1
H371	GUARN. OR 2037/VITON GASKET VITON	1
H394	RONDELLA IN PTFE PTFE WASHER	1



Art. 8390.800 Mod. 390G-20 bar



VISTA ESPLOSA - EXPLODED VIEW

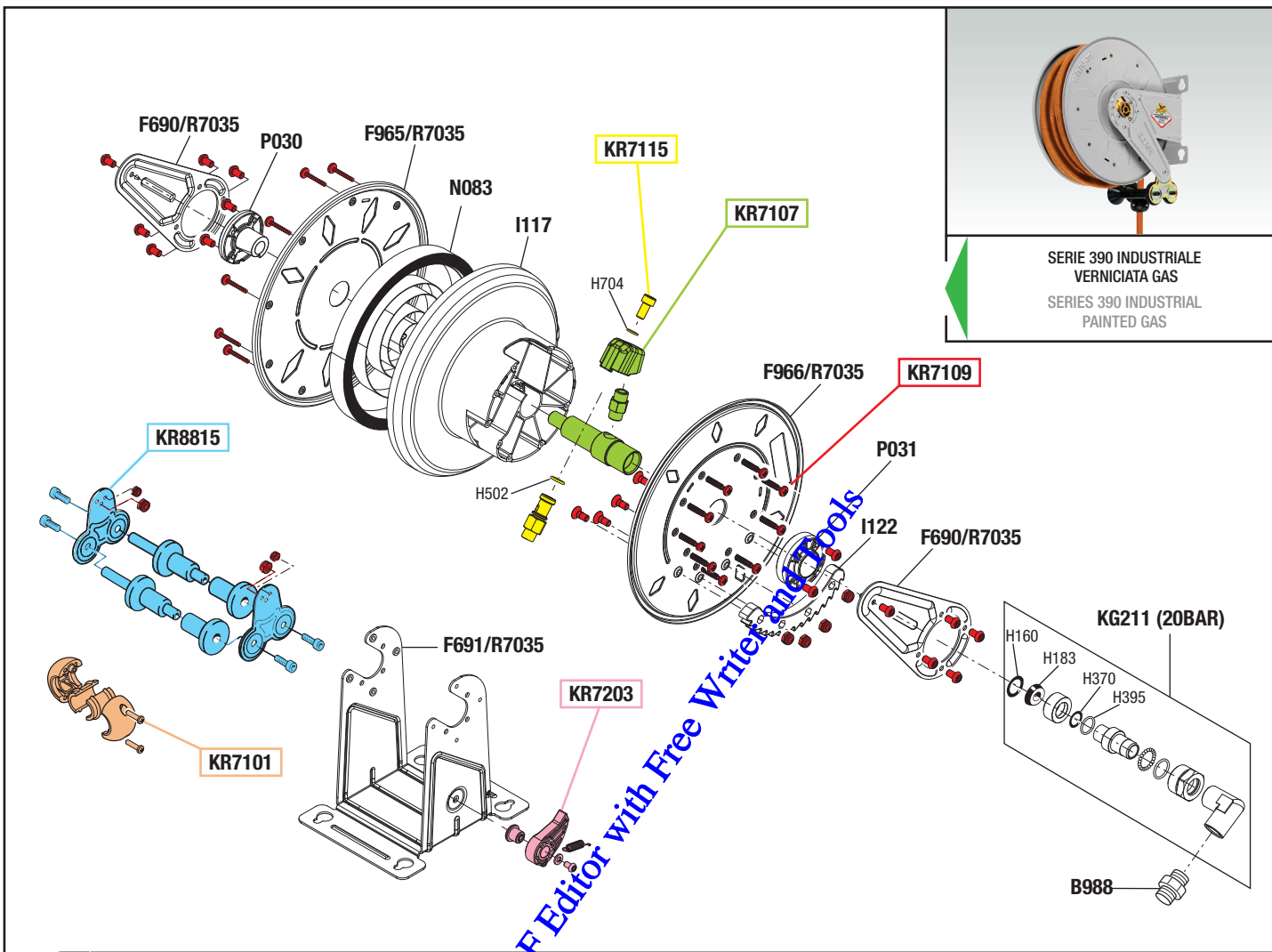

SERIE 390 INDUSTRIALE
VERNICIATA GAS
SERIES 390 INDUSTRIAL
PAINTED GAS

tutti i diritti riservati - all rights reserved

GUIDA RICAMBI - SPARE PARTS GUIDE

KIT RICAMBI
OGNI KIT SOTTO RIPORTATO COMPRENDE I RICAMBI EVIDENZIATI CON LO STESSO COLORE E LE RELATIVE GUARNIZIONI. QUESTI RICAMBI NON SONO FORNIBILI SEPARATAMENTE TRANNE QUELLI CODIFICATI.

SPARE PARTS KITS
EACH KIT SHOWN WITH THE SAME COLOR INCLUDES ALSO THE GASKETS. THE SPARE PARTS INCLUDED IN THE KIT CAN'T BE SUPPLIED SEPARATELY EXCEPT THOSE SHOWN WITH A PROPER CODE.

CODICE CODE	DESCRIZIONE DESCRIPTION	Q.TÀ QTY
KR7101	TAMPONE FERMATUBO HOSE STOP	1
KR7107	PERNO CENTRALE CENTRAL PIVOT	1
KR7115	BULLONE PER ATTACCO RAPIDO BOLT FOR QUICK CONNECTION	1
KR7109	SET VITI AVVOLGITUBO HOSEREEL SCREWS KIT	1
KR7203	DENTE DI ARRESTO DETENT	1
KR8815	KIT PORTA RULLI ROLLERS HOLDING KIT	1

ELENCO RICAMBI FORNIBILI SINGOLARMENTE
LIST OF SPARE PARTS WHICH CAN BE SUPPLIED SEPARATELY

CODICE CODE	DESCRIZIONE DESCRIPTION	Q.TÀ QTY
B988	NIPPLE M 3/8" G sx - M 3/8" G dx NIPPLE M 3/8" G left - M 3/8" G right	1
F690/R7035	BRACCIO ORIENTABILE ADJUSTABLE ARM	2
F691/R7035	STAFFA BRACKET	1
F965/R7035	CARTER LATO MOLLA COVER SPRING GROUP	1
F966/R7035	CARTER LATO CREMAGLIERA COVER RACK GROUP	1
H502	O-RING 3056 "VITON" O-RING 3056 "VITON"	1
H704	O-RING 3037 "VITON" O-RING 3037 "VITON"	1
I117	TAMBURO DRUM	1
I122	CREMAGLIERA RACK	1
KG211	SNODO ARIA-ACQUA 20 BAR JOINT AIR-WATER 20 BAR	1
N083	MOLLA SPRING	1
P030	BOCCOLA LATO MOLLA SPRING SIDE BUSH	1
P031	BOCCOLA LATO CREMAGLIERA RACK SIDE BUSH	1

ELENCO GUARNIZIONI SNODI
JOINTS GASKETS LIST

CODICE CODE	DESCRIZIONE DESCRIPTION	Q.TÀ QTY
H160	O-RING 2093 O-RING 2093	1
H183	GUARNIZIONE GASKET	1
H370	O-RING 2062 "VITON" O-RING 2062 "VITON"	1
H395	RONDELLA IN "PTFE" WASHER "PTFE"	1



Art. 8392.100 Mod. 392-20 bar - Art. 8392.300 Mod. 392-200 bar

VISTA ESPLOSA - EXPLODED VIEW

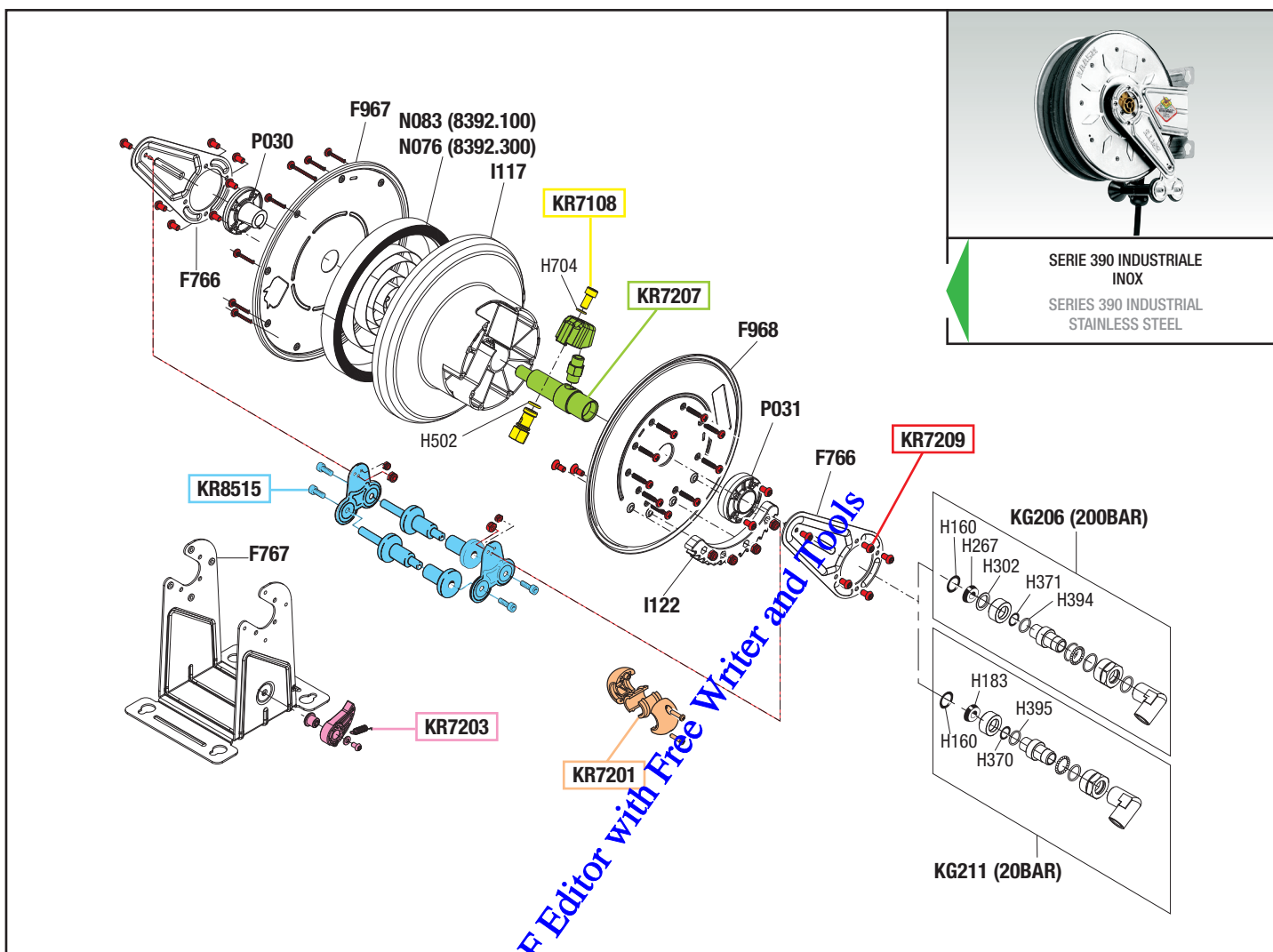

SERIE 390 INDUSTRIALE INOX
SERIES 390 INDUSTRIAL STAINLESS STEEL

GUIDA RICAMBI - SPARE PARTS GUIDE

KIT RICAMBI
OGNI KIT SOTTO RIPORTATO COMPRENDE I RICAMBI EVIDENZIATI CON LO STESSO COLORE E LE RELATIVE GUARNIZIONI. QUESTI RICAMBI NON SONO FORNIBILI SEPARATAMENTE TRANNE QUELLI CODIFICATI.

SPARE PARTS KITS
EACH KIT SHOWN WITH THE SAME COLOR INCLUDES ALSO THE GASKETS. THE SPARE PARTS INCLUDED IN THE KIT CAN'T BE SUPPLIED SEPARATELY EXCEPT THOSE SHOWN WITH A PROPER CODE.

CODICE CODE	DESCRIZIONE DESCRIPTION	Q.TÀ QTY
KR7108	BULLONE PER ATTACCO RAPIDO BOLT FOR QUICK CONNECTION	1
KR7201	TAMPONE FERMATUBO HOSE STOP	1
KR7203	DENTE D'ARRESTO DETENT	1
KR7207	PERNO CENTRALE CENTRAL PIVOT	1
KR7209	SET VITI ARROTOLATORE SET OF SCREWS FOR HOSE REEL	1
KR8515	KIT PORTA RULLI ROLLERS HOLDING KIT	1

ELENCO RICAMBI FORNIBILI SINGOLARMENTE
LIST OF SPARE PARTS WHICH CAN BE SUPPLIED SEPARATELY

CODICE CODE	DESCRIZIONE DESCRIPTION	Q.TÀ QTY
F766	BRACCIO ORIENTABILE SWINGING ARM	2
F767	STAFFA BRACKET	1
F967	CARTER-MOLLA COVER-SPRING GROUP	1
F968	CARTER LATO CREMAGLIERA COVER-SPRING GROUP	1
H502	O-RING 3056 O-RING 3056	1
H704	O-RING 3037 O-RING 3037	1
I117	TAMBURO 300/350 DRUM 300/350	1
I122	CREMAGLIERA RACK	1
KG206	SNODO ACQUA 200 BAR JOINT WATER 200 BAR	1
KG211	SNODO ARIA-ACQUA 20 BAR JOINT AIR-WATER 20 BAR	1
N076	MOLLA (8392.300) SPRING (8392.300)	1
N083	MOLLA (8392.100) SPRING (8392.100)	1
P030	BOCCOLA LATO MOLLA BUSH	1
P031	BOCCOLA LATO CREMAGLIERA BUSH	1

ELENCO GUARNIZIONI SNODI
JOINTS GASKETS LIST

CODICE CODE	DESCRIZIONE DESCRIPTION	Q.TÀ QTY
H160	O-RING 2093 O-RING 2093	1
H183	GUARNIZIONE GASKET	1
H267	GUARNIZIONE VITON GASKET VITON	1
H302	RONDELLA IN PTFE PTFE WASHER	1
H370	O-RING 2062 VITON O-RING 2062 VITON	1
H371	O-RING 2037 VITON O-RING 2037 VITON	1
H394	RONDELLA IN PTFE PTFE GASKET	1
H395	RONDELLA IN PTFE PTFE GASKET	1

tutti i diritti riservati - all rights reserved



Art. 8392.200 Mod. 392-100 bar



VISTA ESPLOSA - EXPLODED VIEW

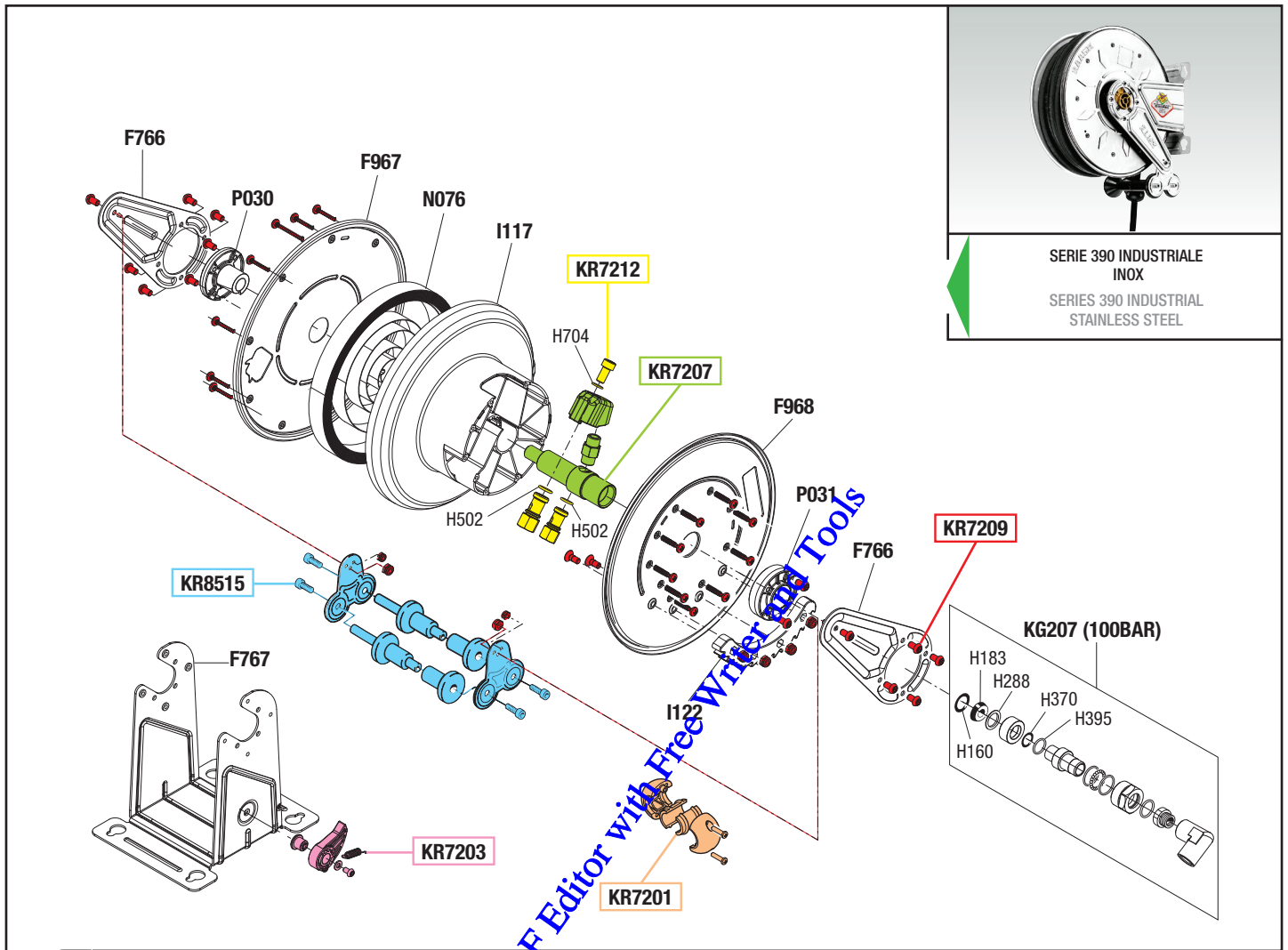

SERIE 390 INDUSTRIALE
INOX
SERIES 390 INDUSTRIAL
STAINLESS STEEL

tutti i diritti riservati - all rights reserved

GUIDA RICAMBI - SPARE PARTS GUIDE

KIT RICAMBI

OGNI KIT SOTTO RIPORTATO COMPRENDE I RICAMBI EVIDENZIATI CON LO STESSO COLORE E LE RELATIVE GUARNIZIONI. QUESTI RICAMBI NON SONO FORNIBILI SEPARATAMENTE TRANNE QUELLI CODIFICATI.

SPARE PARTS KITS

EACH KIT SHOWN WITH THE SAME COLOR INCLUDES ALSO THE GASKETS. THE SPARE PARTS INCLUDED IN THE KIT CAN'T BE SUPPLIED SEPARATELY EXCEPT THOSE SHOWN WITH A PROPER CODE.

CODICE CODE	DESCRIZIONE DESCRIPTION	Q.TÀ QTY
KR7201	TAMPONE FERMATUBO HOSE STOP	1
KR7203	DENTE D'ARRESTO DETENT	1
KR7207	PERNO CENTRALE CENTRAL PIVOT	1
KR7209	SET VITI ARROTOLATORE SET OF SCREWS FOR HOSE REEL	1
KR7212	BULLONE PER ATTACCO RAPIDO BOLT FOR QUICK CONNECTION	1
KR8515	KIT PORTA RULLI ROLLERS HOLDING KIT	1

ELENCO RICAMBI FORNIBILI SINGOLARMENTE

LIST OF SPARE PARTS WHICH CAN BE SUPPLIED SEPARATELY

CODICE CODE	DESCRIZIONE DESCRIPTION	Q.TÀ QTY
F766	BRACCIO ORIENTABILE SWINGING ARM	2
F767	STAFFA BRACKET	1
F967	CARTER-MOLLA COVER-SPRING GROUP	1
F968	CARTER LATO CREMAGLIERA COVER-SPRING GROUP	1
H502	O-RING 3056 O-RING 3056	2
H704	O-RING 3037 O-RING 3037	1
I117	TAMBURO 300/350 DRUM 300/350	1
I122	CREMAGLIERA RACK	1
KG207	SNODO ACQUA 100 BAR JOINT WATER 100 BAR	1
N076	MOLLA SPRING	1
P030	BOCCOLA LATO MOLLA BUSH	1
P031	BOCCOLA LATO CREMAGLIERA BUSH	1

ELENCO GUARNIZIONI SNODI

JOINTS GASKETS LIST

CODICE CODE	DESCRIZIONE DESCRIPTION	Q.TÀ QTY
H160	O-RING 2093 O-RING 2093	1
H183	GUARNIZIONE GASKET	1
H288	RONDELLA IN PTFE PTFE GASKET	1
H370	O-RING 2062 VITON O-RING 2062 VITON	1
H395	RONDELLA IN PTFE PTFE GASKET	1



Art. 8392.350 Mod. 392-400 bar

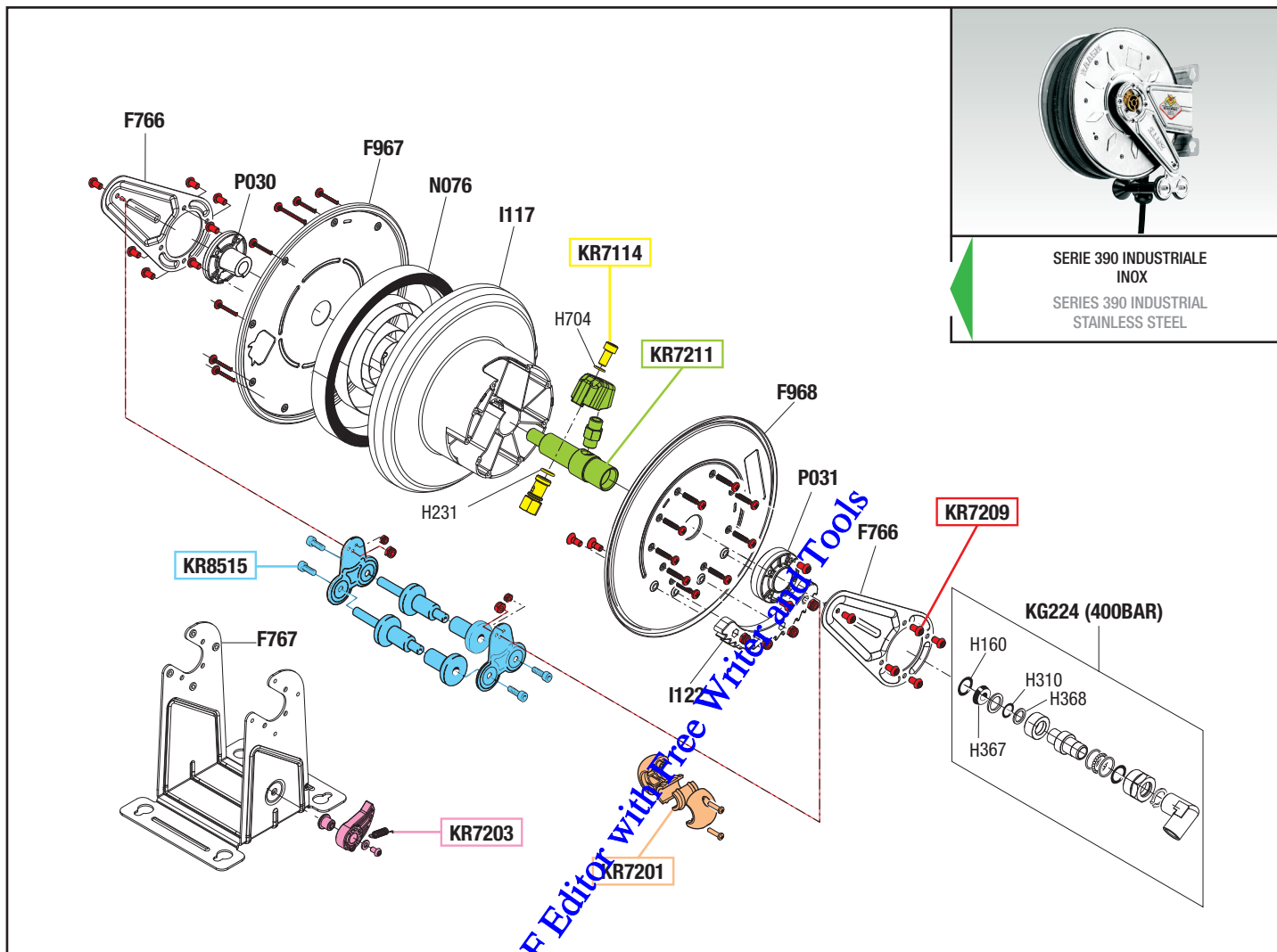

VISTA ESPLOSA - EXPLODED VIEW

SERIE 390 INDUSTRIALE
INOXSERIES 390 INDUSTRIAL
STAINLESS STEEL

GUIDA RICAMBI - SPARE PARTS GUIDE

KIT RICAMBI

OGNI KIT SOTTO RIPORTATO COMPRENDE I RICAMBI EVIDENZIATI CON LO STESSO COLORE E LE RELATIVE GUARNIZIONI. QUESTI RICAMBI NON SONO FORNIBILI SEPARATAMENTE TRANNE QUELLI CODIFICATI.

SPARE PARTS KITS

EACH KIT SHOWN WITH THE SAME COLOR INCLUDES ALSO THE GASKETS. THE SPARE PARTS INCLUDED IN THE KIT CAN'T BE SUPPLIED SEPARATELY EXCEPT THOSE SHOWN WITH A PROPER CODE.

CODICE CODE	DESCRIZIONE DESCRIPTION	Q.TÀ QTY
KR7114	BULLONE PER ATTACCO RAPIDO BOLT FOR QUICK CONNECTION	1
KR7201	TAMPONE FERMATUBO HOSE STOP	1
KR7203	DENTE D'ARRESTO DETENT	1
KR7209	SET VITI ARROTOLATORE SET OF SCREWS FOR HOSE REEL	1
KR7211	PERNO CENTRALE CENTRAL PIVOT	1
KR8515	KIT PORTA RULLI ROLLERS HOLDING KIT	1

ELENCO RICAMBI FORNIBILI SINGOLARMENTE

LIST OF SPARE PARTS WHICH CAN BE SUPPLIED SEPARATELY

CODICE CODE	DESCRIZIONE DESCRIPTION	Q.TÀ QTY
F766	BRACCIO ORIENTABILE SWINGING ARM	2
F767	STAFFA BRACKET	1
F967	CARTER-MOLLA COVER-SPRING GROUP	1
F968	CARTER LATO CREMAGLIERA COVER-SPRING GROUP	1
H231	O-RING 2056 O-RING 2056	1
H704	O-RING 3037 O-RING 3037	1
I117	TAMBURO 300/350 DRUM 300/350	1
I122	CREMAGLIERA RACK	1
KG224	SNODO ACQUA 400 BAR JOINT WATER 400 BAR	1
N076	MOLLA SPRING	1
P030	BOCCOLA LATO MOLLA BUSH	1
P031	BOCCOLA LATO CREMAGLIERA BUSH	1

ELENCO GUARNIZIONI SNODI

JOINTS GASKETS LIST

CODICE CODE	DESCRIZIONE DESCRIPTION	Q.TÀ QTY
H160	O-RING 2093 O-RING 2093	1
H310	O-RING 112 VITON O-RING 112 VITON	1
H367	GUARNIZIONE GASKET	1
H368	RONDELLA IN PTFE PTFE WASHER	1

tutti i diritti riservati - all rights reserved



Art. 8392.500 Mod. 392-600 bar



VISTA ESPLOSA - EXPLODED VIEW

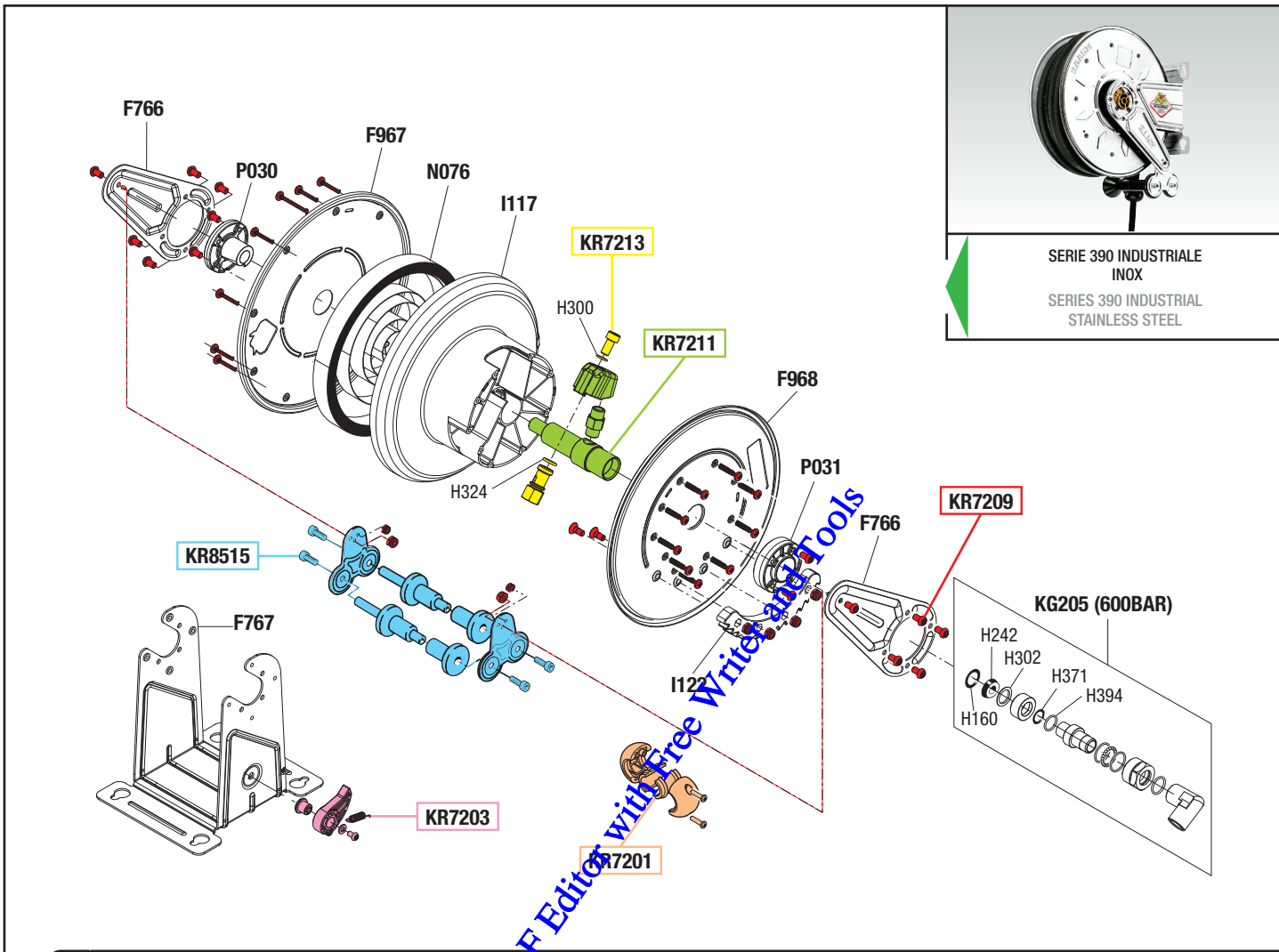

tutti i diritti riservati - all rights reserved

GUIDA RICAMBI - SPARE PARTS GUIDE

KIT RICAMBI
OGNI KIT SOTTO RIPORTATO COMPRENDE I RICAMBI EVIDENZIATI CON LO STESSO COLORE E LE RELATIVE GUARNIZIONI. QUESTI RICAMBI NON SONO FORNIBILI SEPARATAMENTE TRANNE QUELLI CODIFICATI.

SPARE PARTS KITS
EACH KIT SHOWN WITH THE SAME COLOR INCLUDES ALSO THE GASKETS. THE SPARE PARTS INCLUDED IN THE KIT CAN'T BE SUPPLIED SEPARATELY EXCEPT THOSE SHOWN WITH A PROPER CODE.

CODICE CODE	DESCRIZIONE DESCRIPTION	Q.TÀ QTY
KR7201	TAMPONE FERMATUBO HOSE STOP	1
KR7203	DENTE D'ARRESTO DETENT	1
KR7209	SET VITI ARROTOLATORE SET OF SCREWS FOR HOSEREEL	1
KR7211	PERNO CENTRALE CENTRAL PIVOT	1
KR7213	BULLONE PER ATTACCO RAPIDO BOLT FOR QUICK CONNECTION	1
KR8515	KIT PORTA RULLI ROLLERS HOLDING KIT	1

ELENCO RICAMBI FORNIBILI SINGOLARMENTE
LIST OF SPARE PARTS WHICH CAN BE SUPPLIED SEPARATELY

CODICE CODE	DESCRIZIONE DESCRIPTION	Q.TÀ QTY
F766	BRACCIO ORIENTABILE SWINGING ARM	2
F767	STAFFA BRACKET	1
F967	CARTER-MOLLA COVER-SPRING GROUP	1
F968	CARTER LATO CREMAGLIERA COVER-SPRING GROUP	1
H300	O-RING 3037 O-RING 3037	1
H324	O-RING 2056 O-RING 2056	1
I117	TAMBURO 300/350 DRUM 300/350	1
I122	CREMAGLIERA RACK	1
KG205	SNODO GRASSO 600 BAR JOINT GREASE 600 BAR	1
N076	MOLLA SPRING	1
P030	BOCCOLA LATO MOLLA BUSH	1
P031	BOCCOLA LATO CREMAGLIERA BUSH	1

ELENCO GUARNIZIONI SNODI
JOINTS GASKETS LIST

CODICE CODE	DESCRIZIONE DESCRIPTION	Q.TÀ QTY
H160	O-RING 2093 O-RING 2093	1
H242	GUARNIZIONE IM41810-PUR 95 GASKET	1
H302	RONDELLA IN PTFE PTFE WASHER	1
H371	GUARN. OR 2037/VITON GASKET VITON	1
H394	RONDELLA IN PTFE PTFE WASHER	1



Art. 8392.800 Mod. Mod. 392G-20 bar

VISTA ESPLOSA - EXPLODED VIEW

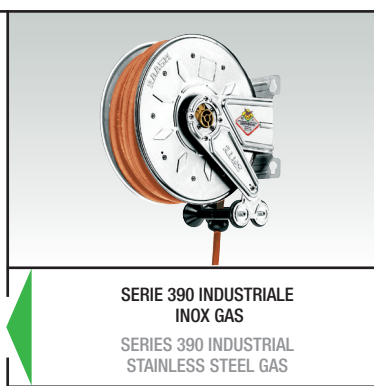
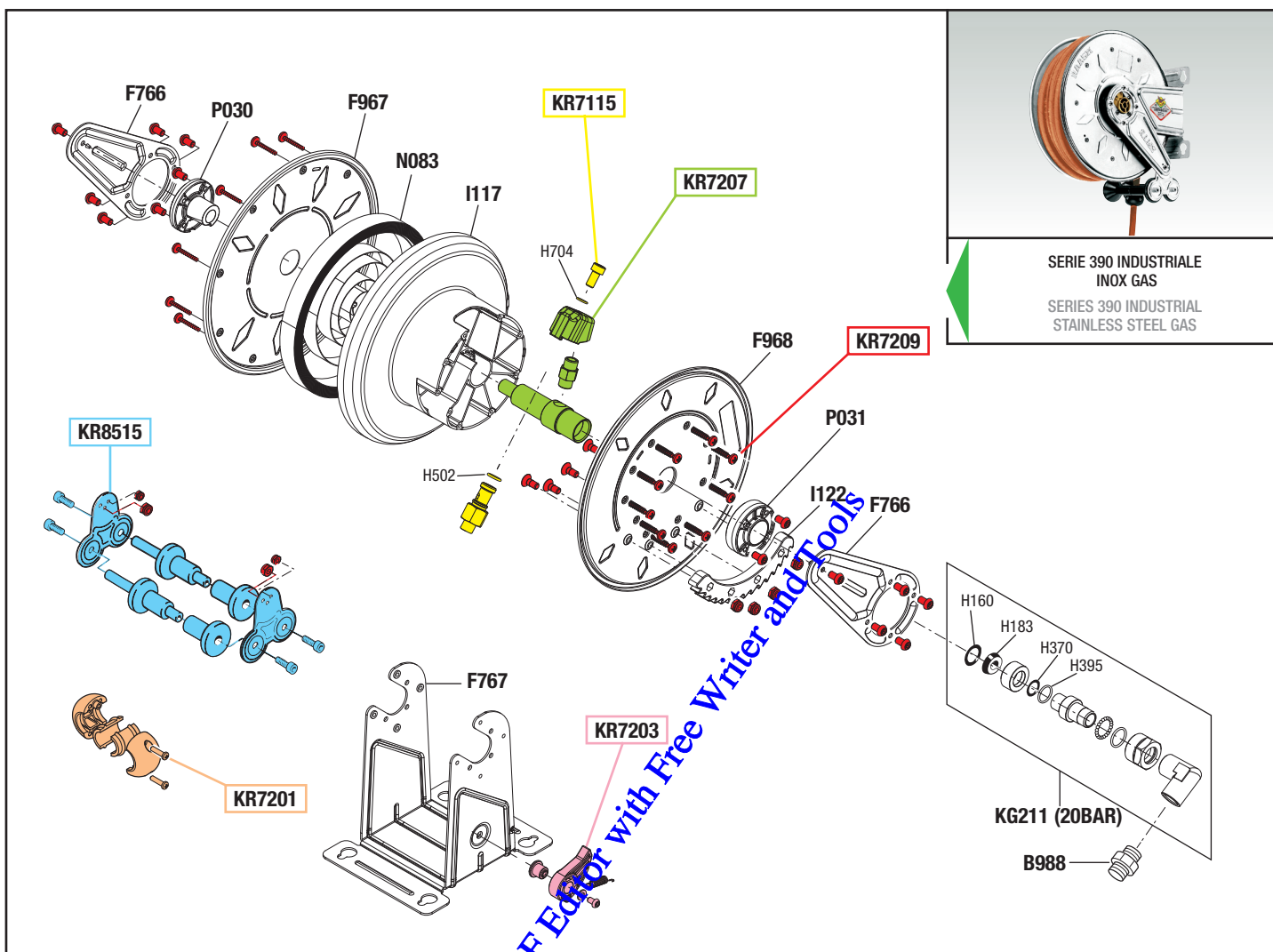

tutti i diritti riservati - all rights reserved

GUIDA RICAMBI - SPARE PARTS GUIDE

KIT RICAMBI
OGNI KIT SOTTO RIPORTATO COMPRENDE I RICAMBI EVIDENZIATI CON LO STESSO COLORE E LE RELATIVE GUARNIZIONI. QUESTI RICAMBI NON SONO FORNIBILI SEPARATAMENTE TRANNE QUELLI CODIFICATI.

SPARE PARTS KITS
EACH KIT SHOWN WITH THE SAME COLOR INCLUDES ALSO THE GASKETS. THE SPARE PARTS INCLUDED IN THE KIT CAN'T BE SUPPLIED SEPARATELY EXCEPT THOSE SHOWN WITH A PROPER CODE.

CODICE CODE	DESCRIZIONE DESCRIPTION	Q.TÀ QTY
KR7115	BULLONE PER ATTACCO RAPIDO BOLT FOR QUICK CONNECTION	1
KR7201	TAMPONE FERMATUBO HOSE STOP	1
KR7203	DENTE DI ARRESTO DETENT	1
KR7207	PERNO CENTRALE CENTRAL PIVOT	1
KR7209	SET VITI AVVOLGITUBO HOSEREEL SCREWS KIT	1
KR8515	KIT PORTA RULLI AVVOLGITUBO ROLLERS HOLDING KIT FOR HOSEREEL	1

ELENCO RICAMBI FORNIBILI SINGOLARMENTE
LIST OF SPARE PARTS WHICH CAN BE SUPPLIED SEPARATELY

CODICE CODE	DESCRIZIONE DESCRIPTION	Q.TÀ QTY
B988	NIPPLE M 3/8" G sx - M 3/8" G dx NIPPLE M 3/8" G left - M 3/8" G right	1
F766	BRACCIO ORIENTABILE ADJUSTABLE ARM	2
F767	STAFFA BRACKET	1
F967	CARTER LATO MOLLA COVER SPRING GROUP	1
F968	CARTER LATO CREMAGLIERA COVER RACK GROUP	1
H502	O-RING 3056 O-RING 3056	1
H704	O-RING 3037 O-RING 3037	1
I117	TAMBURO DRUM	1
I122	CREMAGLIERA RACK	1
KG211	SNODO ARIA-ACQUA 20 BAR JOINT AIR-WATER 20 BAR	1
N083	MOLLA SPRING	1
P030	BOCCOLA LATO MOLLA SPRING SIDE BUSH	1
P031	BOCCOLA LATO CREMAGLIERA RACK SIDE BUSH	1

ELENCO GUARNIZIONI SNODI
JOINTS GASKETS LIST

CODICE CODE	DESCRIZIONE DESCRIPTION	Q.TÀ QTY
H160	O-RING 2093 O-RING 2093	1
H183	GUARNIZIONE GASKET	1
H370	O-RING 2062 "VITON" O-RING 2062 "VITON"	1
H395	RONDELLA IN "PTFE" WASHER "PTFE"	1



Art. 8420.100 Mod. 420-20 bar - Art. 8420.200 Mod. 420-100 bar
 Art. 8420.300 Mod. 420-200 bar - Art. 8420.350 Mod. 420-400 bar
 Art. 8420.400 Mod. 420-150 bar - Art. 8420.500 Mod. 420-600 bar



VISTA ESPLOSA - EXPLODED VIEW

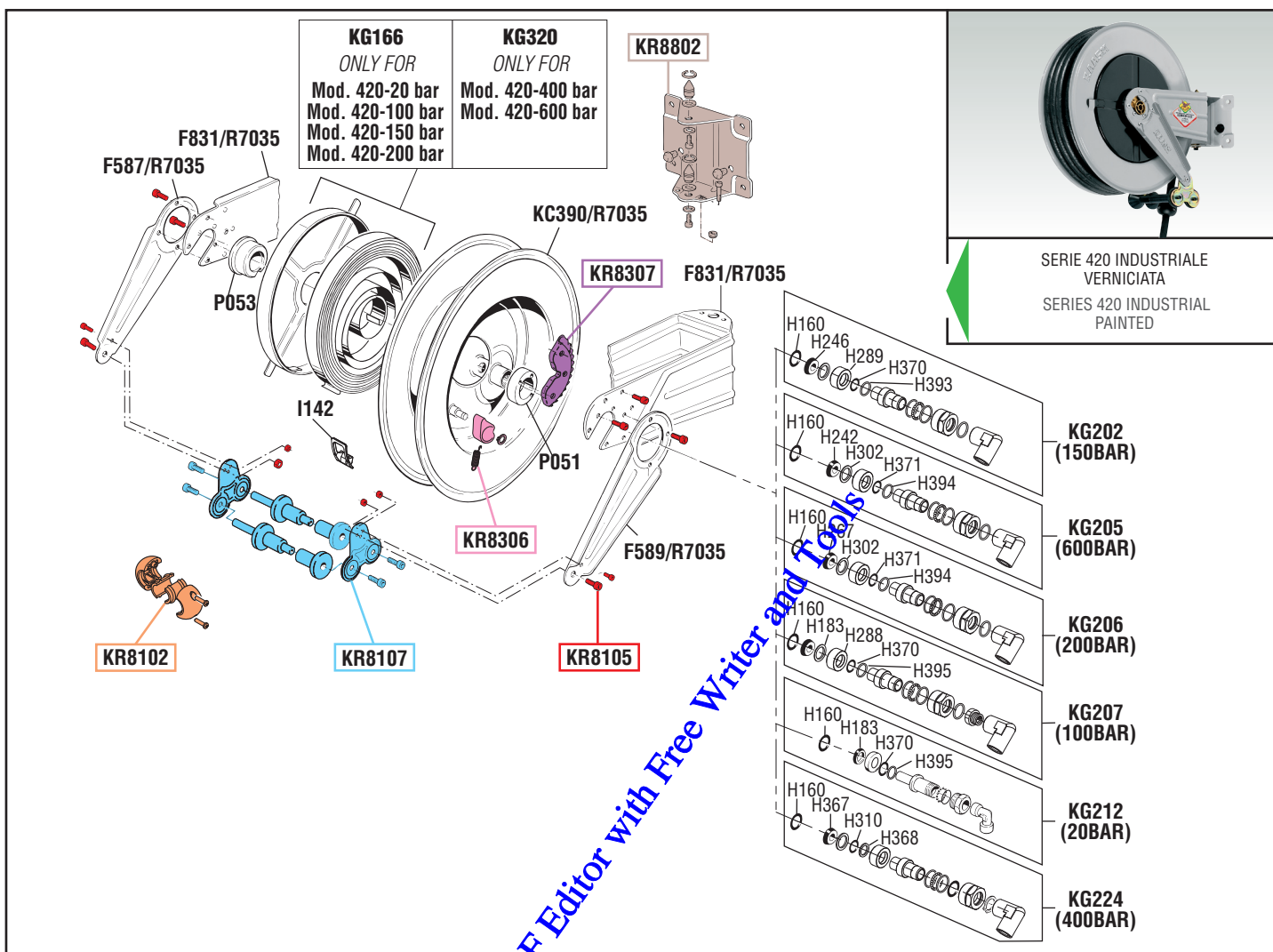

tutti i diritti riservati - all rights reserved

GUIDA RICAMBI - SPARE PARTS GUIDE

KIT RICAMBI
 OGNI KIT SOTTO RIPORTATO COMPRENDE I RICAMBI EVIDENZIATI CON LO STESSO COLORE E LE RELATIVE GUARNIZIONI. QUESTI RICAMBI NON SONO FORNIBILI SEPARATAMENTE TRANNE QUELLI CODIFICATI.

SPARE PARTS KITS
 EACH KIT SHOWN WITH THE SAME COLOR INCLUDES ALSO THE GASKETS. THE SPARE PARTS INCLUDED IN THE KIT CAN'T BE SUPPLIED SEPARATELY EXCEPT THOSE SHOWN WITH A PROPER CODE.

CODICE CODE	DESCRIZIONE DESCRIPTION	Q.TÀ QTY
KR8102	TAMPONE FERMATUBO HOSE STOP	1
KR8105	SET VITI AVVOLGITUBO SET OF SCREWS FOR HOSEREEL	1
KR8107	KIT PORTA RULLI AVVOLGITUBO ROLLERS HOLDING KIT FOR HOSEREEL	1
KR8306	DENTE D'ARRESTO DETENT	1
KR8307	KIT CREMAGLIERA RACK KIT	1
KR8802	STAFFA PER AVVOLGITUBO WALL MOUNTED BRACKET FOR HOSEREEL	1

ELENCO RICAMBI FORNIBILI SINGOLARMENTE
 LIST OF SPARE PARTS WHICH CAN BE SUPPLIED SEPARATELY

CODICE CODE	DESCRIZIONE DESCRIPTION	Q.TÀ QTY
F587/R7035	BRACCIO ORIENTABILE ADJUSTABLE ARM	1
F589/R7035	BRACCIO ORIENTABILE ADJUSTABLE ARM	1
F831/R7035	STAFFA ORIENTABILE SWIVELLING BRACKET	1
I142	INSERTO FORO USCITA TUBO HOSE OUTLET PROTECTION	1
KC390/R7035	TAMBURO AVVOLGITUBO HOSEREEL DRUM	1
KG166	CARTER MOLLA COVER SPRING GROUP	1
KG202	SNODO OLIO 150 BAR JOINT OIL 150 BAR	1
KG205	SNODO GRASSO 600 BAR JOINT GREASE 600 BAR	1
KG206	SNODO ACQUA 200 BAR JOINT WATER 200 BAR	1
KG207	SNODO ACQUA 100 BAR JOINT WATER 100 BAR	1
KG212	SNODO ARIA-ACQUA 20 BAR JOINT AIR-WATER 20 BAR	1
KG224	SNODO ACQUA 400 BAR JOINT WATER 400 BAR	1
KG320	CARTER MOLLA (Art.8420.350-Art.8420.500) COVER SPRING GROUP (Art.8420.350-8420.500)	1
P051	BOCCOLA LATO CREMAGLIERA RACK SIDE BUSH	1
P053	BOCCOLA LATO MOLLA SPRING SIDE BUSH	1

ELENCO GUARNIZIONI SNODI
 JOINTS GASKETS LIST

CODICE CODE	DESCRIZIONE DESCRIPTION	Q.TÀ QTY
H160	O-RING 2093 O-RING 2093	1
H183	GUARNIZIONE GASKET	1
H242	GUARNIZIONE GASKET	1
H246	GUARNIZIONE GASKET	1
H267	GUARNIZIONE "VITON 90SH" GASKET "VITON 90SH"	1
H288	RONDELLA IN "PTFE" WASHER "PTFE"	1
H289	RONDELLA IN "PTFE" WASHER "PTFE"	1
H302	RONDELLA IN "PTFE" WASHER "PTFE"	1
H310	O-RING 112 "VITON" O-RING 112 "VITON"	1
H367	GUARNIZIONE GASKET	1
H368	RONDELLA IN "PTFE" WASHER "PTFE"	1
H370	O-RING 2062 "VITON" O-RING 2062 "VITON"	1
H371	O-RING 2037 "VITON" O-RING 2037 "VITON"	1
H393	RONDELLA IN "PTFE" WASHER "PTFE"	1
H394	RONDELLA IN "PTFE" WASHER "PTFE"	1
H395	RONDELLA IN "PTFE" WASHER "PTFE"	1



Art. 8420.700 Mod. 420 BIN



VISTA ESPLOSA - EXPLODED VIEW

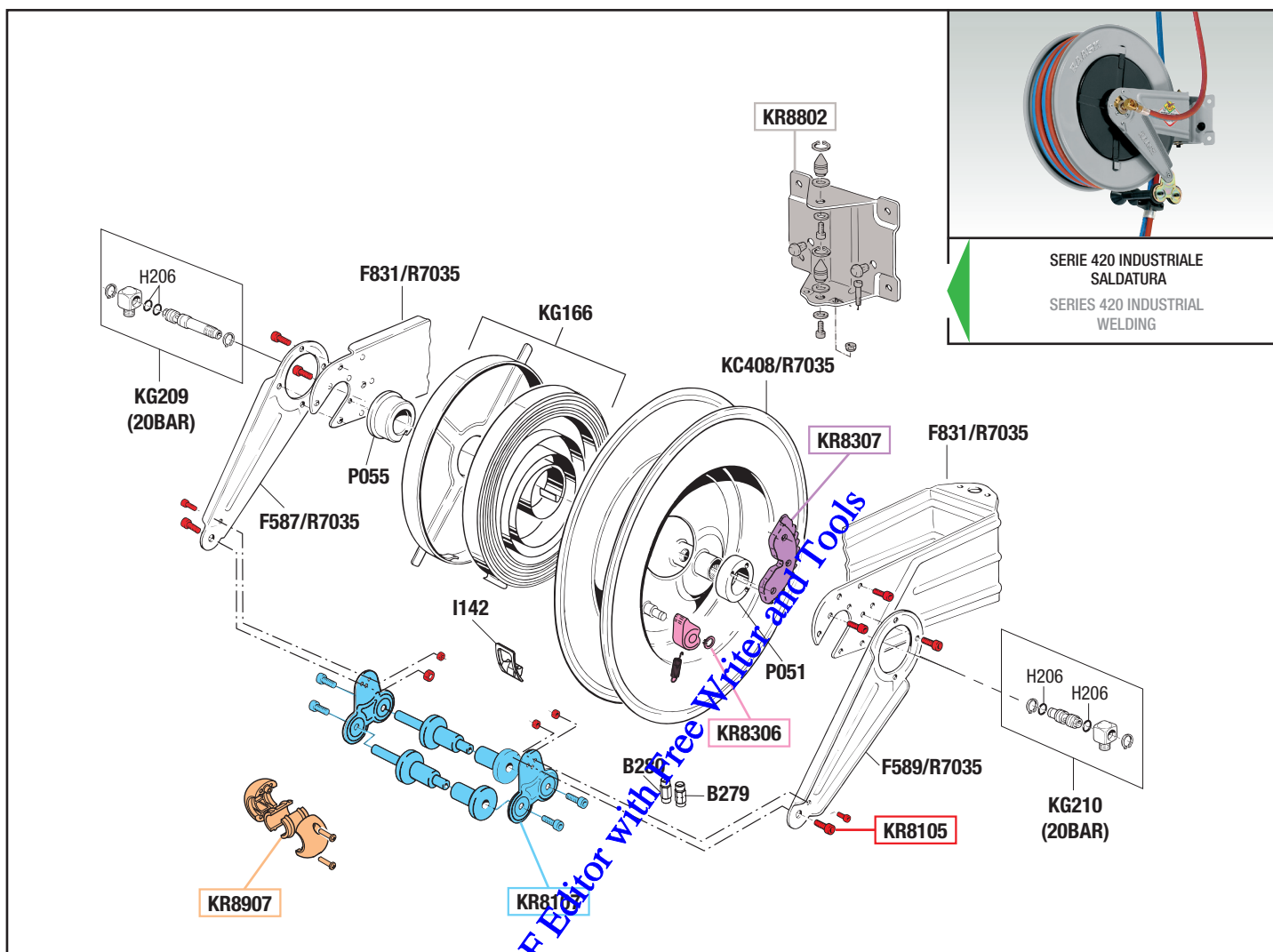

tutti i diritti riservati - all rights reserved

GUIDA RICAMBI - SPARE PARTS GUIDE

KIT RICAMBI

OGNI KIT SOTTO RIPORTATO COMPRENDE I RICAMBI EVIDENZIATI CON LO STESSO COLORE E LE RELATIVE GUARNIZIONI. QUESTI RICAMBI NON SONO FORNIBILI SEPARATAMENTE TRANNE QUELLI CODIFICATI.

SPARE PARTS KITS

EACH KIT SHOWN WITH THE SAME COLOR INCLUDES ALSO THE GASKETS. THE SPARE PARTS INCLUDED IN THE KIT CAN'T BE SUPPLIED SEPARATELY EXCEPT THOSE SHOWN WITH A PROPER CODE.

CODICE CODE	DESCRIZIONE DESCRIPTION	Q.TÀ QTY
KR8105	SET VITI ARROTOLATORE SET OF SCREWS FOR HOSEREEL	1
KR8107	KIT PORTA RULLI ARROTOLATORE ROLLERS HOLDING KIT FOR HOSEREEL	1
KR8306	DENTE D'ARRESTO DETENT	1
KR8307	KIT CREMAGLIERA RACK KIT	1
KR8802	STAFFA PER ARROTOLATORE WALL MOUNTED BRACKET FOR HOSEREEL	1
KR8907	TAMPONE FERMATUBO HOSE STOP	1

ELENCO RICAMBI FORNIBILI SINGOLARMENTE

LIST OF SPARE PARTS WHICH CAN BE SUPPLIED SEPARATELY

CODICE CODE	DESCRIZIONE DESCRIPTION	Q.TÀ QTY
B279	NIPPES SINISTRO LEFT ADAPTOR	1
B280	NIPPES DESTRO RIGHT ADAPTOR	1
F587/R7035	BRACCIO ORIENTABILE SWINGING ARM	1
F589/R7035	BRACCIO ORIENTABILE SWINGING ARM	1
F831/R7035	STAFFA ORIENTABILE SWIVELLING BRACKET	1
I142	INSERTO USCITA TUBO HOSE OUTLET PROTECTION	1
KC408/R7035	TAMBURO 420 420 HOSEREEL DRUM	1
KG166	CARTER-MOLLA COVER SPRING-GROUP	1
KG209	SNODO SINISTRO 20 BAR LEFT JOINT 20 BAR	1
KG210	SNODO DESTRO 20 BAR RIGHT JOINT 20 BAR	1
P051	BOCCOLA LATO CREMAGLIERA BUSH	1
P055	BOCCOLA LATO MOLLA BUSH	1

ELENCO GUARNIZIONI SNODI

JOINTS GASKETS LIST

CODICE CODE	DESCRIZIONE DESCRIPTION	Q.TÀ QTY
H206	O-RING 3043 VITON O-RING 3043 VITON	4



Art. 8420.800 Mod. 420 GAS



VISTA ESPLOSA - EXPLODED VIEW

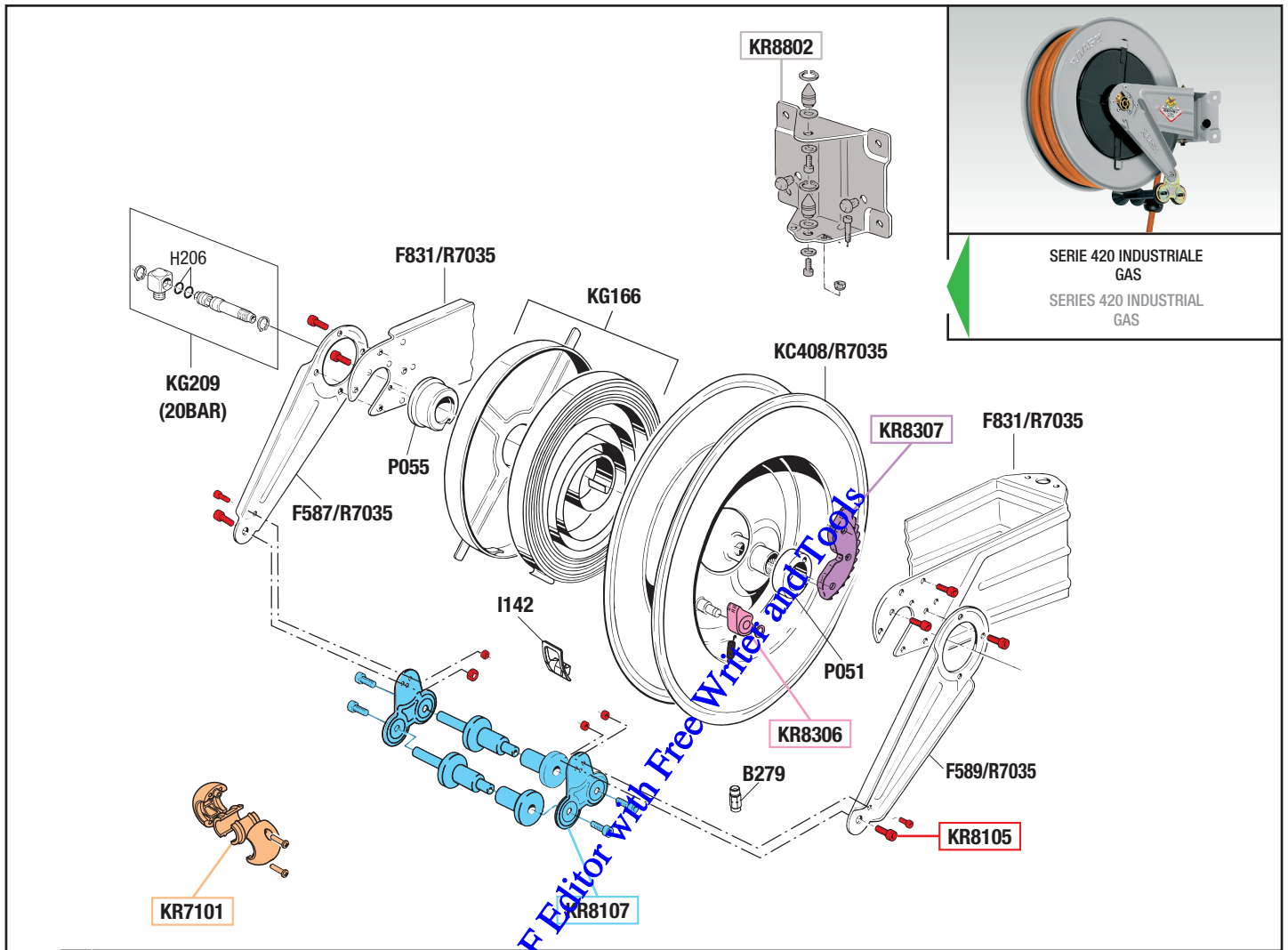

tutti i diritti riservati - all rights reserved

GUIDA RICAMBI - SPARE PARTS GUIDE

KIT RICAMBI

OGNI KIT SOTTO RIPORTATO COMPRENDE I RICAMBI EVIDENZIATI CON LO STESSO COLORE E LE RELATIVE GUARNIZIONI. QUESTI RICAMBI NON SONO FORNIBILI SEPARATAMENTE TRANNE QUELLI CODIFICATI.

SPARE PARTS KITS

EACH KIT SHOWN WITH THE SAME COLOR INCLUDES ALSO THE GASKETS. THE SPARE PARTS INCLUDED IN THE KIT CAN'T BE SUPPLIED SEPARATELY EXCEPT THOSE SHOWN WITH A PROPER CODE.

CODICE CODE	DESCRIZIONE DESCRIPTION	Q.TÀ QTY
KR7101	TAMPONE FERMATUBO HOSE STOP	1
KR8105	SET VITI ARROTOLATORE SET OF SCREWS FOR HOSE REEL	1
KR8107	KIT PORTA RULLI ARROTOLATORE ROLLERS HOLDING KIT FOR HOSE REEL	1
KR8306	DENTE D'ARRESTO DETENT	1
KR8307	KIT CREMAGLIERA RACK KIT	1
KR8802	STAFFA PER ARROTOLATORE WALL MOUNTED BRACKET FOR HOSE REEL	1

ELENCO RICAMBI FORNIBILI SINGOLARMENTE

LIST OF SPARE PARTS WHICH CAN BE SUPPLIED SEPARATELY

CODICE CODE	DESCRIZIONE DESCRIPTION	Q.TÀ QTY
B279	NIPPES SINISTRO LEFT ADAPTOR	1
F587/R7035	BRACCIO ORIENTABILE SWINGING ARM	1
F589/R7035	BRACCIO ORIENTABILE SWINGING ARM	1
F831/R7035	STAFFA ORIENTABILE SWIVELLING BRACKET	1
I142	INSERTO FORO USCITA TUBO HOSE OUTLET PROTECTION	1
KC408/R7035	TAMBURO 420 420 HOSE REEL DRUM	1
KG166	CARTER-MOLLA COVER-SPRING GROUP	1
KG209	SNODO SX 20 BAR HOSE REEL JOINT	1
P051	BOCCOLA LATO CREMAGLIERA BUSH	1
P055	BOCCOLA LATO MOLLA BUSH	1

ELENCO GUARNIZIONI SNODI

JOINTS GASKETS LIST

CODICE CODE	DESCRIZIONE DESCRIPTION	Q.TÀ QTY
H206	O-RING 3043 VITON O-RING 3043 VITON	2



Art. 8420.1000 Mod. 420-2X20 bar



VISTA ESPLOSA - EXPLODED VIEW

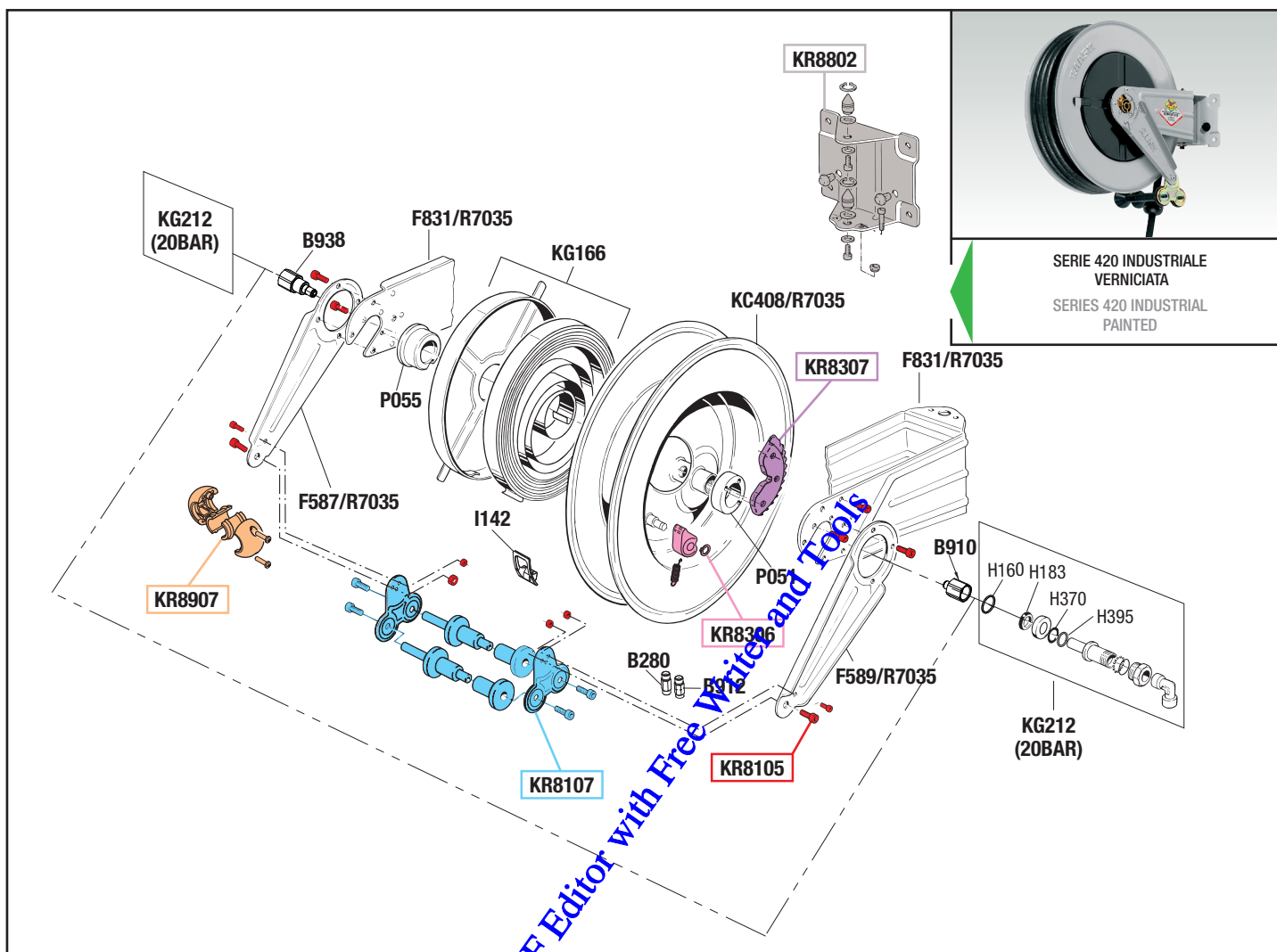

SERIE 420 INDUSTRIALE
VERNICIATA
SERIES 420 INDUSTRIAL
PAINTED

GUIDA RICAMBI - SPARE PARTS GUIDE

KIT RICAMBI

OGNI KIT SOTTO RIPORTATO COMPRENDE I RICAMBI EVIDENZIATI CON LO STESSO COLORE E LE RELATIVE GUARNIZIONI. QUESTI RICAMBI NON SONO FORNIBILI SEPARATAMENTE TRANNE QUELLI CODIFICATI.

SPARE PARTS KITS

EACH KIT SHOWN WITH THE SAME COLOR INCLUDES ALSO THE GASKETS. THE SPARE PARTS INCLUDED IN THE KIT CAN'T BE SUPPLIED SEPARATELY EXCEPT THOSE SHOWN WITH A PROPER CODE.

CODICE CODE	DESCRIZIONE DESCRIPTION	Q.TÀ QTY
KR8105	SET VITI ARROTOLATORE SET OF SCREWS FOR HOSEREEL	1
KR8107	KIT PORTA RULLI ARROTOLATORE ROLLERS HOLDING KIT FOR HOSEREEL	1
KR8306	DENTE D'ARRESTO DETENT	1
KR8307	KIT CREMAGLIERA RACK KIT	1
KR8802	STAFFA PER ARROTOLATORE WALL MOUNTED BRACKET FOR HOSEREEL	1
KR8907	TAMPONE FERMATUBO HOSE STOP	1

ELENCO RICAMBI FORNIBILI SINGOLARMENTE

LIST OF SPARE PARTS WHICH CAN BE SUPPLIED SEPARATELY

CODICE CODE	DESCRIZIONE DESCRIPTION	Q.TÀ QTY
B280	NIPPLES ADAPTOR	1
B910	ADATTATORE SNODO SWIVEL JOINT ADAPTOR	1
B912	NIPPLES ADAPTOR	1
B938	ADATTATORE SNODO SWIVEL JOINT ADAPTOR	1
F587/R7035	BRACCIO ORIENTABILE SWINGING ARM	1
F589/R7035	BRACCIO ORIENTABILE SWINGING ARM	1
F831/R7035	STAFFA ORIENTABILE SWIVELLING BRACKET	1
I142	INSERTO USCITA TUBO HOSE OUTLET PROTECTION	1
KC408/R7035	TAMBURO 420 420 HOSEREEL DRUM	1
KG166	CARTER-MOLLA COVER SPRING-GROUP	1
KG212	SNODO ARIA-ACQUA 20 BAR JOINT AIR-WATER 20 BAR	2
P051	BOCCOLA LATO CREMAGLIERA BUSH	1
P055	BOCCOLA LATO MOLLA BUSH	1

ELENCO GUARNIZIONI SNODI

JOINTS GASKETS LIST

CODICE CODE	DESCRIZIONE DESCRIPTION	Q.TÀ QTY
H160	O-RING 2093 O-RING 2093	1
H183	GUARNIZIONE GASKET	1
H370	O-RING 2062 VITON O-RING 2062 VITON	1
H395	RONDELLA PTFE WASHER PTFE	1

tutti i diritti riservati - all rights reserved



Art. 8422.100 Mod. 422-20 bar - Art. 8422.500 Mod. 422-600 bar
 Art. 8424.200 Mod. 424-100 bar - Art. 8424.300 Mod. 424-200 bar
 Art. 8424.350 Mod. 424-400 bar



VISTA ESPLOSA - EXPLODED VIEW

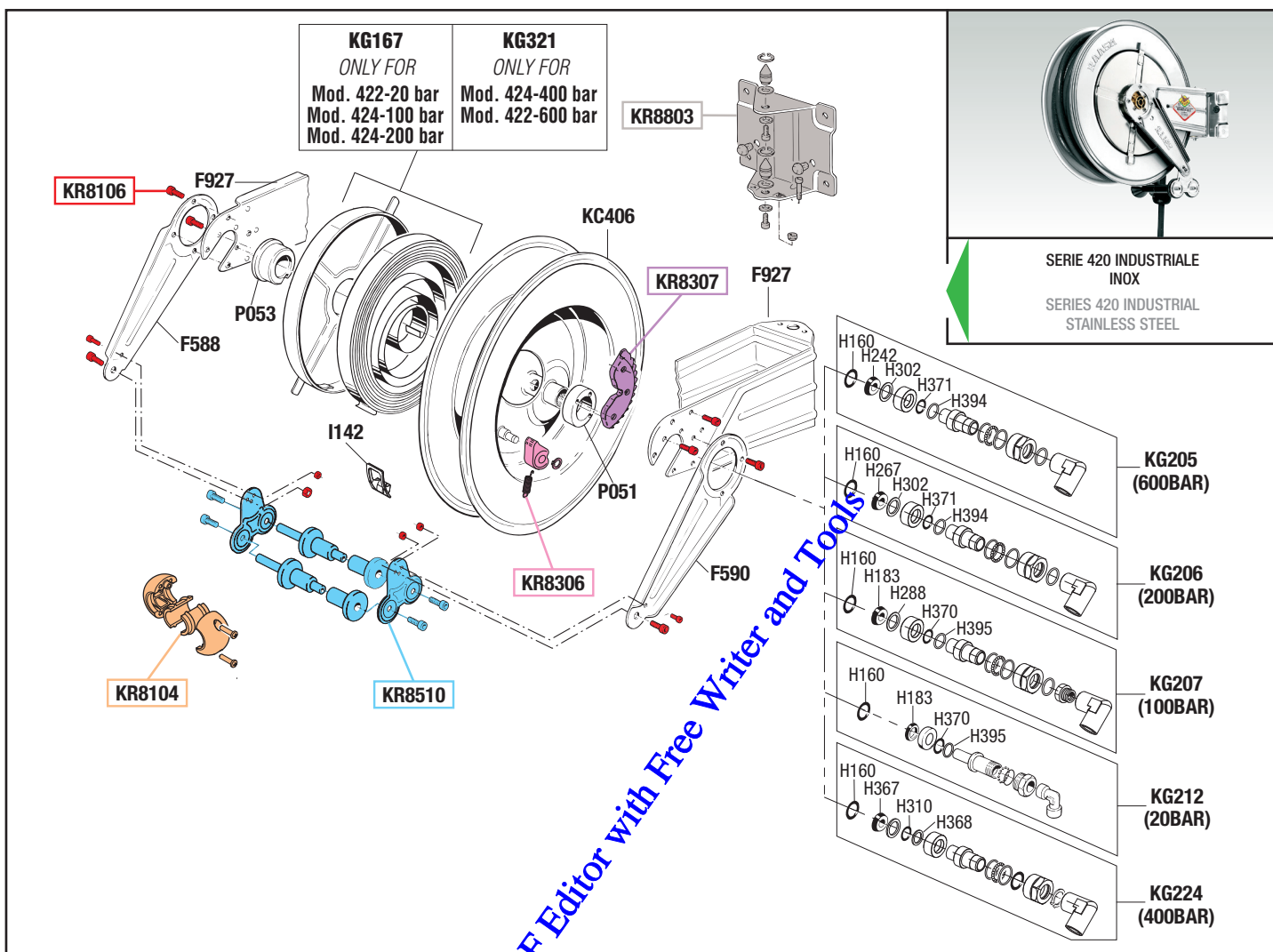

GUIDA RICAMBI - SPARE PARTS GUIDE

KIT RICAMBI
 OGNI KIT SOTTO RIPORTATO COMPRENDE I RICAMBI EVIDENZIATI CON LO STESSO COLORE E LE RELATIVE GUARNIZIONI. QUESTI RICAMBI NON SONO FORNIBILI SEPARATAMENTE TRANNE QUELLI CODIFICATI.

SPARE PARTS KITS
 EACH KIT SHOWN WITH THE SAME COLOR INCLUDES ALSO THE GASKETS. THE SPARE PARTS INCLUDED IN THE KIT CAN'T BE SUPPLIED SEPARATELY EXCEPT THOSE SHOWN WITH A PROPER CODE.

CODICE CODE	DESCRIZIONE DESCRIPTION	Q.TÀ QTY
KR8104	TAMPONE FERMATUBO HOSE STOP	1
KR8106	SET VITI ARROTOLATORE SET OF SCREWS FOR HOSEREEL	1
KR8306	DENTE D'ARRESTO DETENT	1
KR8307	KIT CREMAGLIERA RACK KIT	1
KR8510	KIT PORTA RULLI ARROTOLATORE ROLLERS HOLDING KIT FOR HOSEREEL	1
KR8803	STAFFA PER ARROTOLATORE WALL MOUNTED BRACKET FOR HOSEREEL	1

ELENCO RICAMBI FORNIBILI SINGOLARMENTE
 LIST OF SPARE PARTS WHICH CAN BE SUPPLIED SEPARATELY

CODICE CODE	DESCRIZIONE DESCRIPTION	Q.TÀ QTY
F588	BRACCIO ORIENTABILE SWINGING ARM	1
F590	BRACCIO ORIENTABILE SWINGING ARM	1
F927	STAFFA ORIENTABILE SWIVELLING BRACKET	1
I142	INSERTO USCITA TUBO HOSE OUTLET PROTECTION	1
KC406	TAMBURO 420 420 HOSEREEL DRUM	1
KG167	CARTER-MOLLA COVER SPRING-GROUP	1
KG205	SNODO GRASSO 600 BAR JOINT GREASE 600 BAR	1
KG206	SNODO ACQUA 200 BAR JOINT WATER 200 BAR	1
KG207	SNODO ACQUA 100 BAR JOINT WATER 100 BAR	1
KG212	SNODO ARIA-ACQUA 20 BAR JOINT AIR-WATER 20 BAR	1
KG224	SNODO ACQUA 400 BAR JOINT WATER 400 BAR	1
KG321	CARTER-MOLLA (Art.8424.350-8422.500) COVER SPRING-GROUP (Art.8424.350-8422.500)	1
P051	BOCCOLA LATO CREMAGLIERA BUSH	1
P053	BOCCOLA LATO MOLLA BUSH	1

ELENCO GUARNIZIONI SNODI
 JOINTS GASKETS LIST

CODICE CODE	DESCRIZIONE DESCRIPTION	Q.TÀ QTY
H160	O-RING 2093 O-RING 2093	1
H183	GUARNIZIONE GASKET	1
H242	GUARNIZIONE M4 1810-PUR95 GASKET	1
H267	GUARNIZIONE VITON 90SH GASKET	1
H288	RONDELLA IN PTFE PTFE WASHER	1
H302	RONDELLA IN PTFE PTFE WASHER	1
H310	GUARNIZIONE OR 112 VITON GASKET	1
H367	GUARNIZIONE GASKET	1
H368	RONDELLA IN PTFE PTFE WASHER	1
H370	GUARNIZIONE OR 2062 VITON GASKET	1
H371	GUARNIZIONE OR 2037 VITON GASKET	1
H394	RONDELLA IN PTFE PTFE WASHER	1
H395	RONDELLA IN PTFE PTFE WASHER	1

tutti i diritti riservati - all rights reserved



Art. 8430.100 Mod. 430-20 bar - Art. 8430.200 Mod. 430-100 bar
 Art. 8430.300 Mod. 430-200 bar - Art. 8430.350 Mod. 430-400 bar
 Art. 8430.400 Mod. 430-150 bar - Art. 8430.500 Mod. 430-600 bar



VISTA ESPLOSA - EXPLODED VIEW

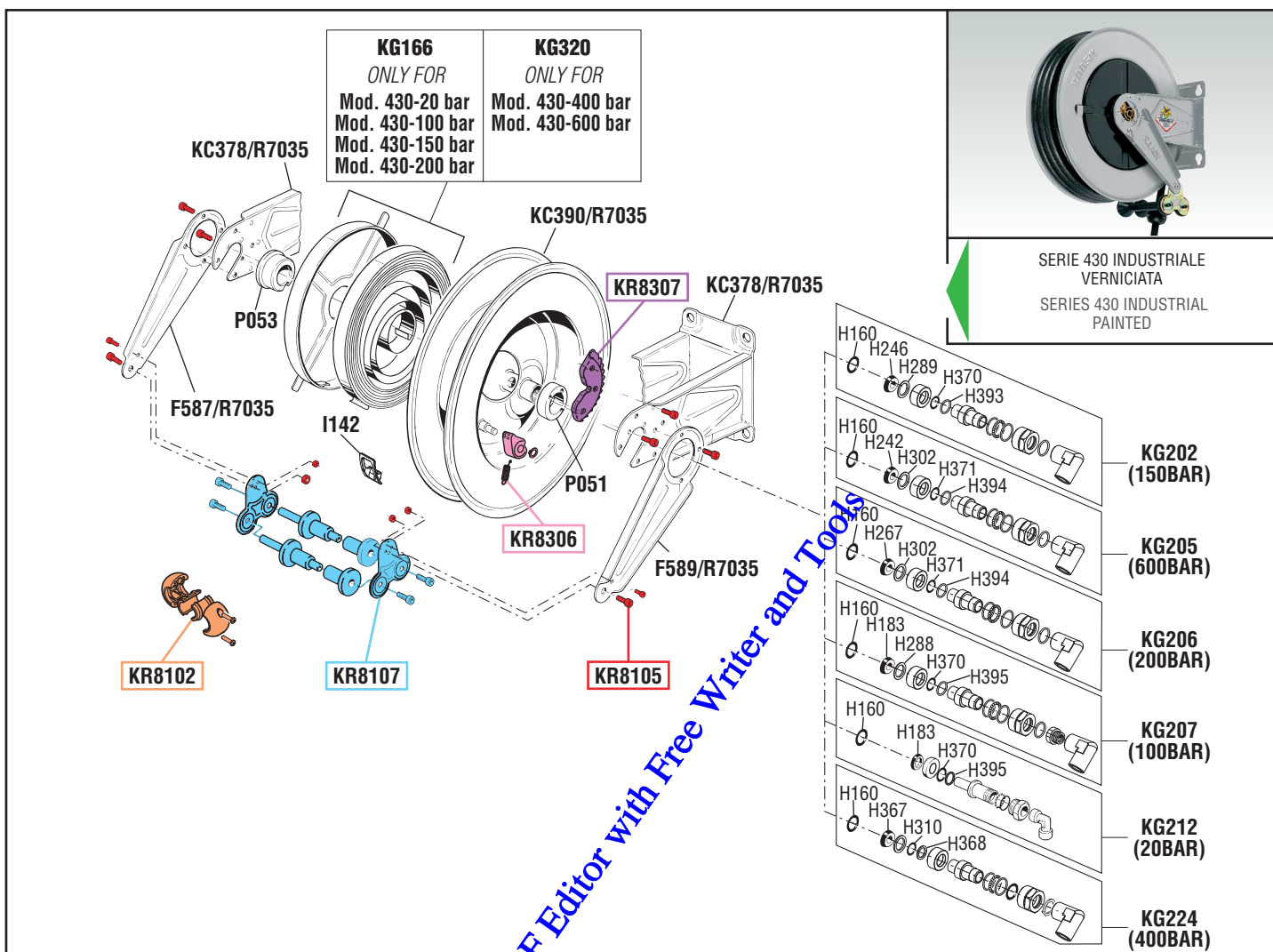

tutti i diritti riservati - all rights reserved

GUIDA RICAMBI - SPARE PARTS GUIDE

KIT RICAMBI
 OGNI KIT SOTTO RIPORTATO COMPRENDE I RICAMBI EVIDENZIATI CON LO STESSO COLORE E LE RELATIVE GUARNIZIONI. QUESTI RICAMBI NON SONO FORNIBILI SEPARATAMENTE TRANNE QUELLI CODIFICATI.
SPARE PARTS KITS
 EACH KIT SHOWN WITH THE SAME COLOR INCLUDES ALSO THE GASKETS. THE SPARE PARTS INCLUDED IN THE KIT CAN'T BE SUPPLIED SEPARATELY EXCEPT THOSE SHOWN WITH A PROPER CODE.

CODICE CODE	DESCRIZIONE DESCRIPTION	Q.TÀ QTY
KR8102	TAMPONE FERMATUBO HOSE STOP	1
KR8105	SET VITI AVVOLGITUBO SET OF SCREWS FOR HOSEREEL	1
KR8107	KIT PORTA RULLI AVVOLGITUBO ROLLERS HOLDING KIT FOR HOSEREEL	1
KR8306	DENTE D'ARRESTO DETENT	1
KR8307	KIT CREMAGLIERA RACK KIT	1

ELENCO RICAMBI FORNIBILI SINGOLARMENTE
 LIST OF SPARE PARTS WHICH CAN BE SUPPLIED SEPARATELY

CODICE CODE	DESCRIZIONE DESCRIPTION	Q.TÀ QTY
F587/R7035	BRACCIO ORIENTABILE ADJUSTABLE ARM	1
F589/R7035	BRACCIO ORIENTABILE ADJUSTABLE ARM	1
I142	INSERTO FORO USCITA TUBO HOSE OUTLET PROTECTION	1
KC378/R7035	SUPPORTO AVVOLGITUBO HOSEREEL SUPPORT	1
KC390/R7035	TAMBURNO AVVOLGITUBO HOSEREEL DRUM	1
KG166	CARTER MOLLA COVER SPRING GROUP	1
KG202	SNODO OLIO 150 BAR JOINT OIL 150 BAR	1
KG205	SNODO GRASSO 600 BAR JOINT GREASE 600 BAR	1
KG206	SNODO ACQUA 200 BAR JOINT WATER 200 BAR	1
KG207	SNODO ACQUA 100 BAR JOINT WATER 100 BAR	1
KG212	SNODO ARIA-ACQUA 20 BAR JOINT AIR-WATER 20 BAR	1
KG224	SNODO ACQUA 400 BAR JOINT WATER 400 BAR	1
KG320	CARTER MOLLA (Art.8430.350-8430.500) COVER SPRING GROUP (Art.8430.350-8430.500)	1
P051	BOCCOLA LATO CREMAGLIERA RACK SIDE BUSH	1
P053	BOCCOLA LATO MOLLA SPRING SIDE BUSH	1

ELENCO GUARNIZIONI SNODI
 JOINTS GASKETS LIST

CODICE CODE	DESCRIZIONE DESCRIPTION	Q.TÀ QTY
H160	O-RING 2093 O-RING 2093	1
H183	GUARNIZIONE GASKET	1
H242	GUARNIZIONE GASKET	1
H246	GUARNIZIONE GASKET	1
H267	GUARNIZIONE "VITON 90SH" GASKET "VITON 90SH"	1
H288	RONDELLA IN "PTFE" WASHER "PTFE"	1
H289	RONDELLA IN "PTFE" WASHER "PTFE"	1
H302	RONDELLA IN "PTFE" WASHER "PTFE"	1
H310	O-RING 112 "VITON" O-RING 112 "VITON"	1
H367	GUARNIZIONE GASKET	1
H368	RONDELLA IN "PTFE" WASHER "PTFE"	1
H370	O-RING 2062 "VITON" O-RING 2062 "VITON"	1
H371	O-RING 2037 "VITON" O-RING 2037 "VITON"	1
H393	RONDELLA IN "PTFE" WASHER "PTFE"	1
H394	RONDELLA IN "PTFE" WASHER "PTFE"	1
H395	RONDELLA IN "PTFE" WASHER "PTFE"	1



Art. 8430.700 Mod. 430 BIN



VISTA ESPLOSA - EXPLODED VIEW

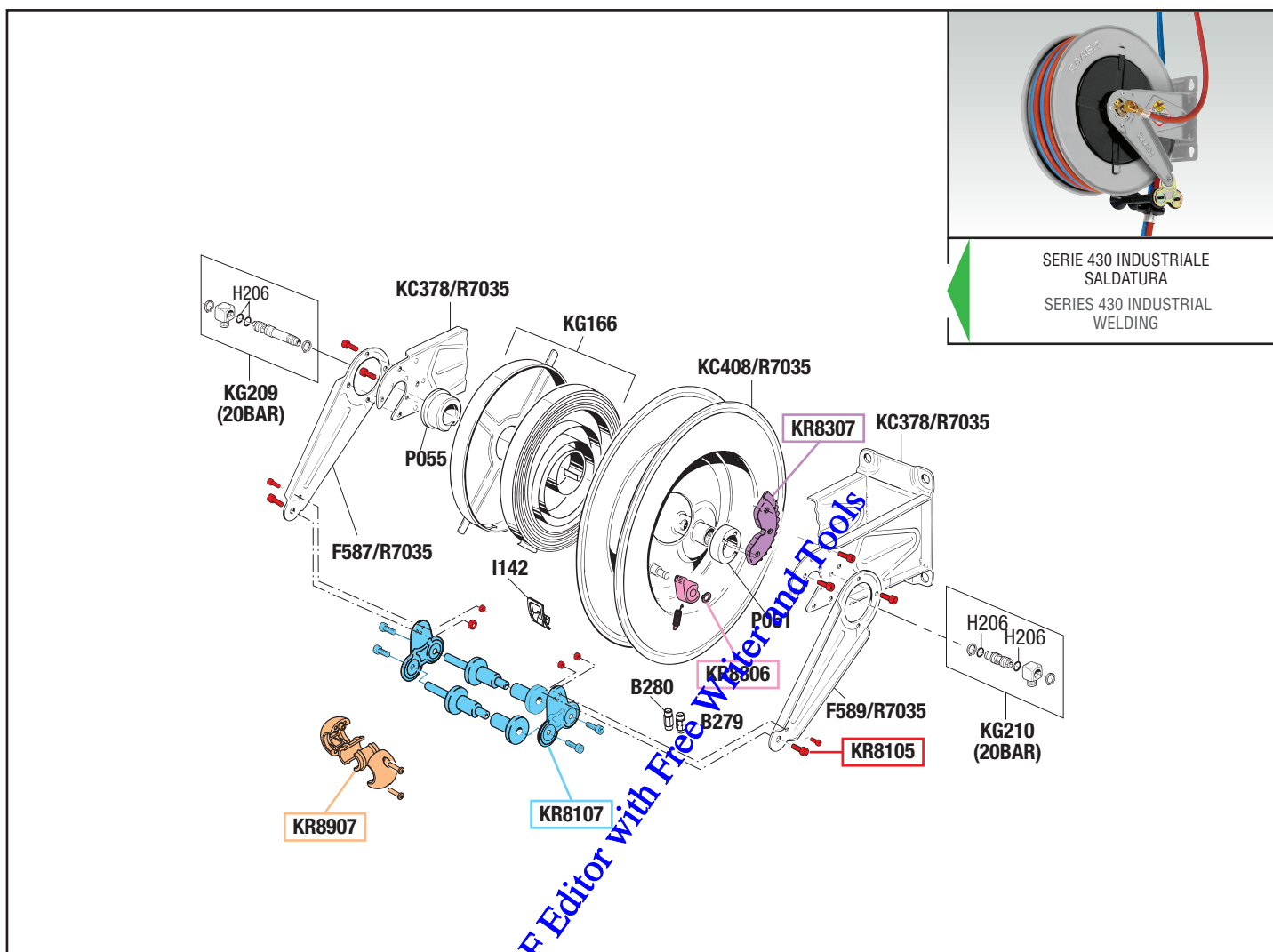

tutti i diritti riservati - all rights reserved

GUIDA RICAMBI - SPARE PARTS GUIDE

KIT RICAMBI

OGNI KIT SOTTO RIPORTATO COMPRENDE I RICAMBI EVIDENZIATI CON LO STESSO COLORE E LE RELATIVE GUARNIZIONI. QUESTI RICAMBI NON SONO FORNIBILI SEPARATAMENTE TRANNE QUELLI CODIFICATI.

SPARE PARTS KITS

EACH KIT SHOWN WITH THE SAME COLOR INCLUDES ALSO THE GASKETS. THE SPARE PARTS INCLUDED IN THE KIT CAN'T BE SUPPLIED SEPARATELY EXCEPT THOSE SHOWN WITH A PROPER CODE.

CODICE CODE	DESCRIZIONE DESCRIPTION	Q.TÀ QTY
KR8105	SET VITI ARROTOLATORE SET OF SCREWS FOR HOSEREEL	1
KR8107	KIT PORTA RULLI ARROTOLATORE ROLLERS HOLDING KIT FOR HOSEREEL	1
KR8306	DENTE D'ARRESTO DETENT	1
KR8307	KIT CREMAGLIERA RACK KIT	1
KR8907	TAMPONE FERMATUBO HOSE STOP	1

ELENCO RICAMBI FORNIBILI SINGOLARMENTE

LIST OF SPARE PARTS WHICH CAN BE SUPPLIED SEPARATELY

CODICE CODE	DESCRIZIONE DESCRIPTION	Q.TÀ QTY
B279	NIPPES SINISTRO LEFT ADAPTOR	1
B280	NIPPES DESTRO RIGHT ADAPTOR	1
F587/R7035	BRACCIO ORIENTABILE SWINGING ARM	1
F589/R7035	BRACCIO ORIENTABILE SWINGING ARM	1
I142	INSERTO USCITA TUBO HOSE OUTLET PROTECTION	1
KC378/R7035	SUPPORTO ARROTOLATORE HOSEREEL SUPPORT	1
KC408/R7035	TAMBURO 420 420 HOSEREEL DRUM	1
KG166	CARTER-MOLLA COVER SPRING-GROUP	1
KG209	SNODO SINISTRO 20 BAR LEFT JOINT 20 BAR	1
KG210	SNODO DESTRO 20 BAR RIGHT JOINT 20 BAR	1
P051	BOCCOLA LATO CREMAGLIERA BUSH	1
P055	BOCCOLA LATO MOLLA BUSH	1

ELENCO GUARNIZIONI SNODI

JOINTS GASKETS LIST

CODICE CODE	DESCRIZIONE DESCRIPTION	Q.TÀ QTY
H206	O-RING 3043 VITON O-RING 3043 VITON	4



Art. 8430.800 Mod. 430 GAS



VISTA ESPLOSA - EXPLODED VIEW

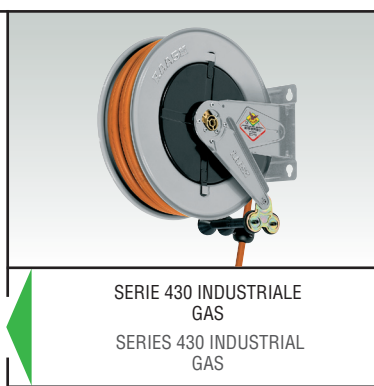
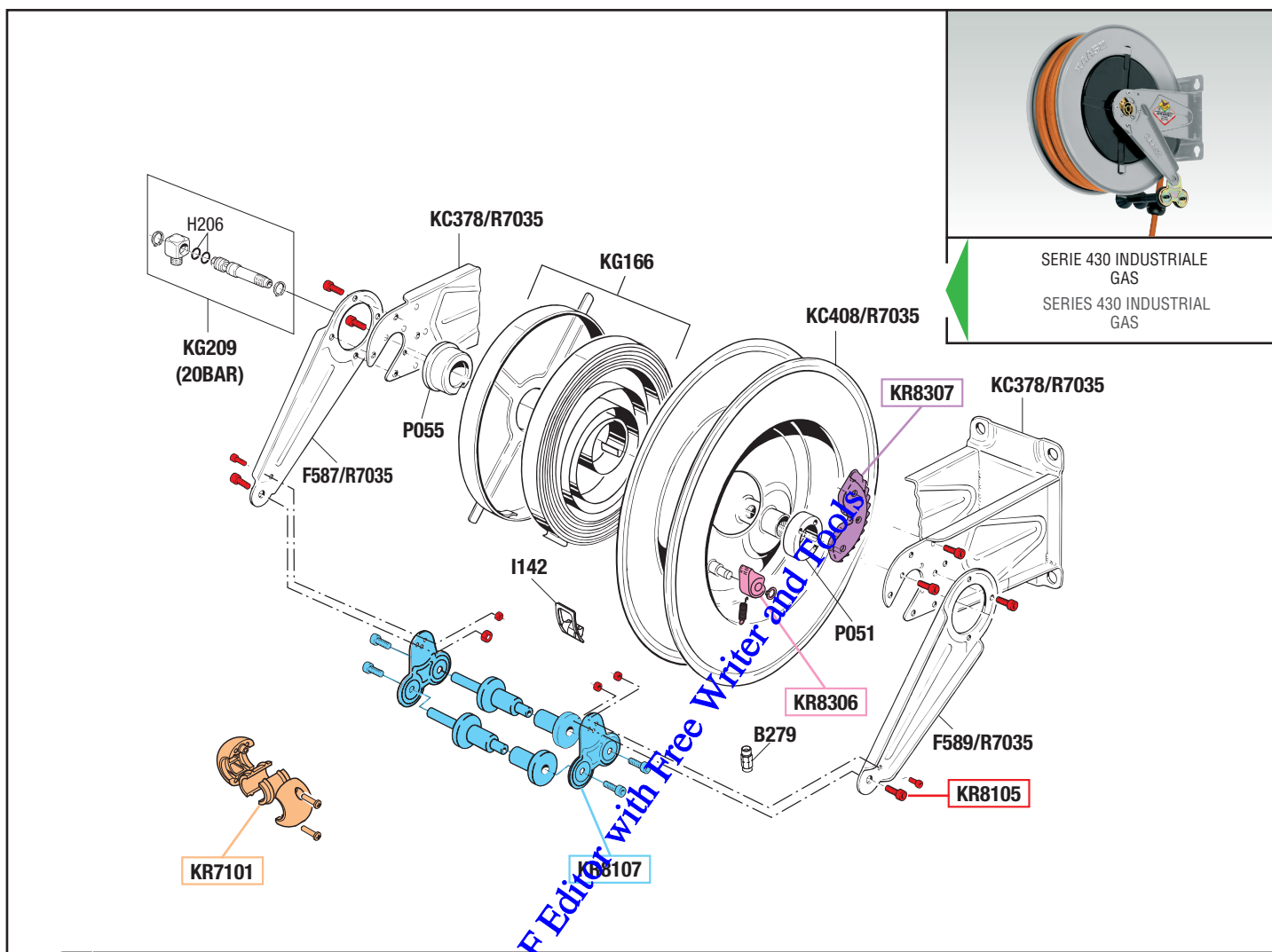

GUIDA RICAMBI - SPARE PARTS GUIDE

KIT RICAMBI
OGNI KIT SOTTO RIPORTATO COMPRENDE I RICAMBI EVIDENZIATI CON LO STESSO COLORE E LE RELATIVE GUARNIZIONI. QUESTI RICAMBI NON SONO FORNIBILI SEPARATAMENTE TRANNE QUELLI CODIFICATI.

SPARE PARTS KITS
EACH KIT SHOWN WITH THE SAME COLOR INCLUDES ALSO THE GASKETS. THE SPARE PARTS INCLUDED IN THE KIT CAN'T BE SUPPLIED SEPARATELY EXCEPT THOSE SHOWN WITH A PROPER CODE.

CODICE CODE	DESCRIZIONE DESCRIPTION	Q.TÀ QTY
KR7101	TAMPONE FERMATUBO HOSE STOP	1
KR8105	SET VITI ARROTOLATORE SET OF SCREWS FOR	1
KR8107	KIT PORTA RULLI ARROTOLATORE ROLLERS HOLDING KIT FOR HOSEREEL	1
KR8306	DENTE D'ARRESTO DETENT	1
KR8307	KIT CREMAGLIERA RACK KIT	1

ELENCO RICAMBI FORNIBILI SINGOLARMENTE
LIST OF SPARE PARTS WHICH CAN BE SUPPLIED SEPARATELY

CODICE CODE	DESCRIZIONE DESCRIPTION	Q.TÀ QTY
B279	NIPPES SINISTRO LEFT ADAPTOR	1
F587/R7035	BRACCIO ORIENTABILE SWINGING ARM	1
F589/R7035	BRACCIO ORIENTABILE SWINGING ARM	1
I142	INSERTO FORO USCITA TUBO HOSE OUTLET PROTECTION	1
KC378/R7035	SUPPORTO ARROTOLATORE HOSEREEL SUPPORT	1
KC408/R7035	TAMBURO 420 420 HOSEREEL DRUM	1
KG166	CARTER-MOLLA COVER-SPRING GROUP	1
KG209	SNODO SX 20 BAR HOSEREEL JOINT	1
P051	BOCCOLA LATO CREMAGLIERA BUSH	1
P055	BOCCOLA LATO MOLLA BUSH	1

ELENCO GUARNIZIONI SNODI
JOINTS GASKETS LIST

CODICE CODE	DESCRIZIONE DESCRIPTION	Q.TÀ QTY
H206	O-RING 3043 VITON O-RING 3043 VITON	2

tutti i diritti riservati - all rights reserved



Art. 8430.1000 Mod. 430-2X20 bar - Art. 8430.4000 Mod. 430-2X200 bar



VISTA ESPLOSA - EXPLODED VIEW

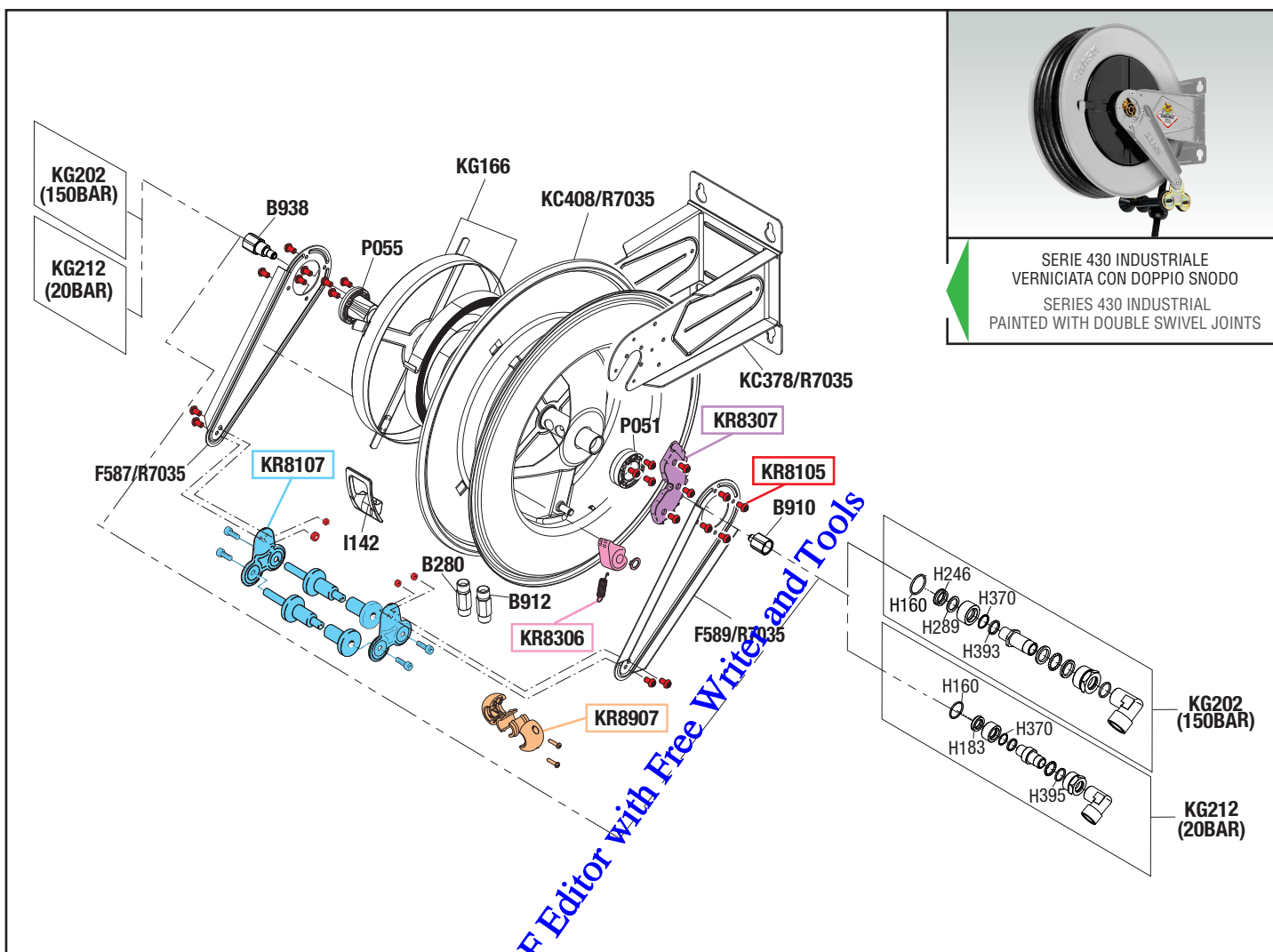

SERIE 430 INDUSTRIALE
VERNICIATA CON DOPIO SNODO
SERIES 430 INDUSTRIAL
PAINTED WITH DOUBLE SWIVEL JOINTS

GUIDA RICAMBI - SPARE PARTS GUIDE

KIT RICAMBI
OGNI KIT SOTTO RIPORTATO COMPRENDE I RICAMBI EVIDENZIATI CON LO STESSO COLORE E LE RELATIVE GUARNIZIONI. QUESTI RICAMBI NON SONO FORNIBILI SEPARATAMENTE TRANNE QUELLI CODIFICATI.

SPARE PARTS KITS
EACH KIT SHOWN WITH THE SAME COLOR INCLUDES ALSO THE GASKETS. THE SPARE PARTS INCLUDED IN THE KIT CAN'T BE SUPPLIED SEPARATELY EXCEPT THOSE SHOWN WITH A PROPER CODE.

CODICE CODE	DESCRIZIONE DESCRIPTION	Q.TÀ QTY
KR8105	SET VITI ARROTOLATORE SET OF SCREWS FOR HOSEREEL	1
KR8107	KIT PORTA RULLI ARROTOLATORE ROLLERS HOLDING KIT FOR HOSEREEL	1
KR8306	DENTE D'ARRESTO DETENT	1
KR8307	KIT CREMAGLIERA RACK KIT	1
KR8907	TAMPONE FERMATUBO HOSE STOP	1

ELENCO RICAMBI FORNIBILI SINGOLARMENTE
LIST OF SPARE PARTS WHICH CAN BE SUPPLIED SEPARATELY

CODICE CODE	DESCRIZIONE DESCRIPTION	Q.TÀ QTY
B280	NIPPES SINISTRO LEFT ADAPTOR	1
B910	ADATTATORE ADAPTOR	1
B912	NIPPES DESTRO RIGHT ADAPTOR	1
B938	ADATTATORE ADAPTOR	1
F587/R7035	BRACCIO ORIENTABILE SWINGING ARM	1
F589/R7035	BRACCIO ORIENTABILE SWINGING ARM	1
I142	INSERTO FORO USCITA TUBO HOSE OUTLET PROTECTION	1
KC378/R7035	STAFFA BRACKET	1
KC408/R7035	TAMBURO 430 DRUM 430	1
KG166	CARTER MOLLA COVER SPRING GROUP	2
KG202	SNODO OLIO 150 BAR JOINT OIL 150 BAR	2
KG212	SNODO ARIA-ACQUA 20 BAR JOINT AIR-WATER 20 BAR	2
P051	BOCCOLA LATO CREMAGLIERA BUSH	1
P055	BOCCOLA LATO MOLLA BUSH	1

ELENCO GUARNIZIONI SNODI
JOINTS GASKETS LIST

CODICE CODE	DESCRIZIONE DESCRIPTION	Q.TÀ QTY
H160	O-RING 2093 O-RING 2093	1
H183	GUARNIZIONE GASKET	1
H246	GUARNIZIONE GASKET	1
H289	RONDELLA IN "PTFE" WASHER "PTFE"	1
H370	GUARNIZIONE OR 2062 VITON GASKET	1
H393	RONDELLA IN "PTFE" WASHER "PTFE"	1
H395	RONDELLA IN PTFE PTFE WASHER	1

tutti i diritti riservati - all rights reserved



Art. 8430.3000 Mod. 430-2X200 bar - Art. 8430.5000 Mod. 430-2X400 bar

VISTA ESPLOSA - EXPLODED VIEW

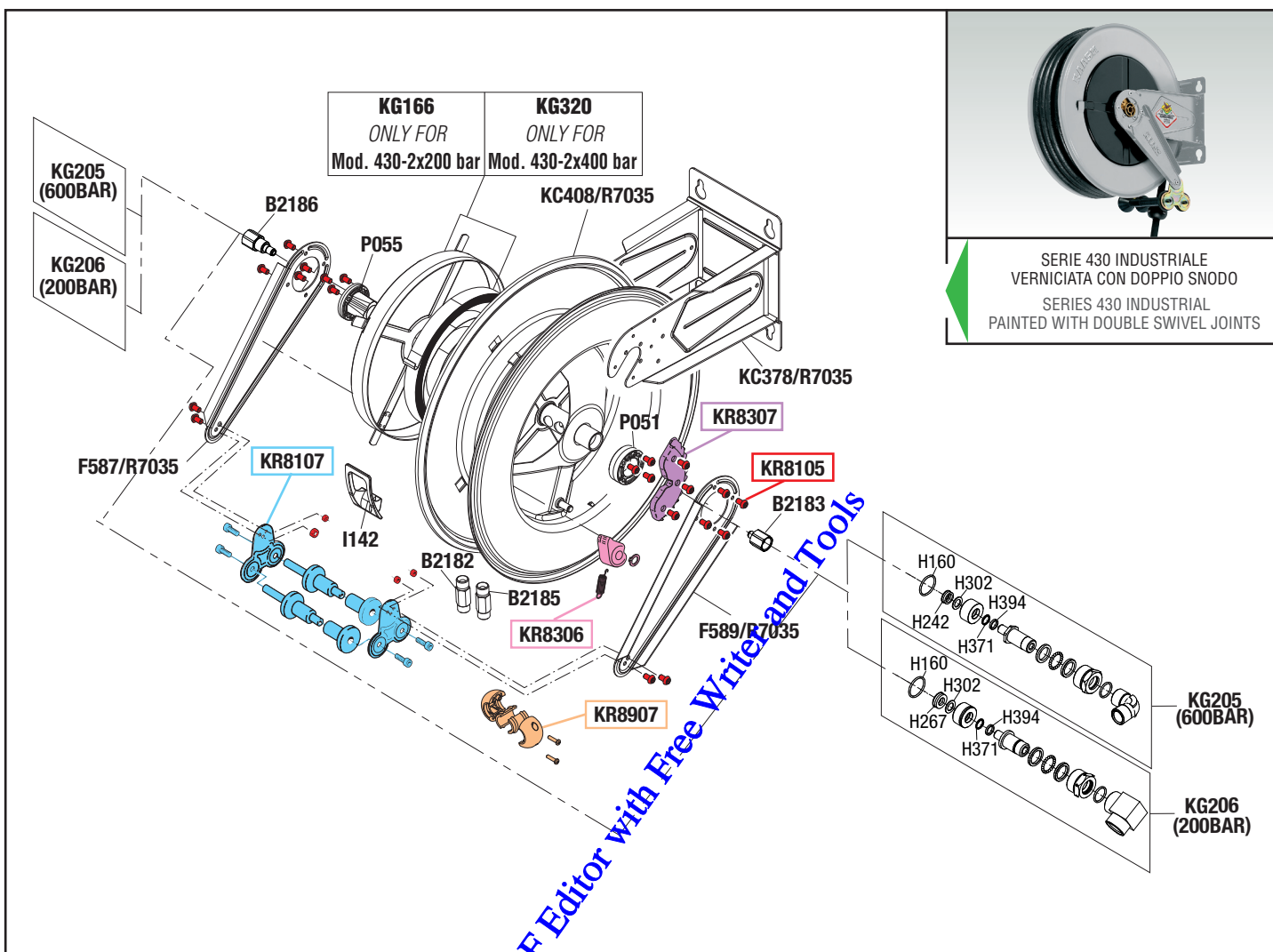

tutti i diritti riservati - all rights reserved

GUIDA RICAMBI - SPARE PARTS GUIDE

KIT RICAMBI
OGNI KIT SOTTO RIPORTATO COMPRENDE I RICAMBI EVIDENZIATI CON LO STESSO COLORE E LE RELATIVE GUARNIZIONI. QUESTI RICAMBI NON SONO FORNIBILI SEPARATAMENTE TRANNE QUELLI CODIFICATI.

SPARE PARTS KITS
EACH KIT SHOWN WITH THE SAME COLOR INCLUDES ALSO THE GASKETS. THE SPARE PARTS INCLUDED IN THE KIT CAN'T BE SUPPLIED SEPARATELY EXCEPT THOSE SHOWN WITH A PROPER CODE.

CODICE CODE	DESCRIZIONE DESCRIPTION	Q.TÀ QTY
KR8105	SET VITI ARROTOLATORE SET OF SCREWS FOR HOSEREEL	1
KR8107	KIT PORTA RULLI ARROTOLATORE ROLLERS HOLDING KIT FOR HOSEREEL	1
KR8306	DENTE D'ARRESTO DETENT	1
KR8307	KIT CREMAGLIERA RACK KIT	1
KR8907	TAMPONE FERMATUBO HOSE STOP	1

ELENCO RICAMBI FORNIBILI SINGOLARMENTE
LIST OF SPARE PARTS WHICH CAN BE SUPPLIED SEPARATELY

CODICE CODE	DESCRIZIONE DESCRIPTION	Q.TÀ QTY
B2182	NIPPES SINISTRO LEFT ADAPTOR	1
B2183	ADATTATORE ADAPTOR	1
B2185	NIPPES DESTRO RIGHT ADAPTOR	1
B2186	ADATTATORE ADAPTOR	1
F587/R7035	BRACCIO ORIENTABILE SWINGING ARM	1
F589/R7035	BRACCIO ORIENTABILE SWINGING ARM	1
I142	INSERTO FORO USCITA TUBO HOSE OUTLET PROTECTION	1
KC378/R7035	STAFFA BRACKET	1
KC408/R7035	TAMBURO 430 DRUM 430	1
KG166	CARTER MOLLA (Art. 8430.3000) COVER SPRING GROUP (Art. 8430.3000)	1
KG205	SNODO GRASSO 600 BAR JOINT GREASE 600 BAR	2
KG206	SNODO ACQUA 200 BAR JOINT WATER 200 BAR	2
KG320	CARTER MOLLA (Art. 8430.5000) COVER SPRING GROUP (Art. 8430.5000)	1
P051	BOCCOLA LATO CREMAGLIERA BUSH	1
P055	BOCCOLA LATO MOLLA BUSH	1

ELENCO GUARNIZIONI SNODI
JOINTS GASKETS LIST

CODICE CODE	DESCRIZIONE DESCRIPTION	Q.TÀ QTY
H160	O-RING 2093 O-RING 2093	1
H242	GUARNIZIONE GASKET	1
H267	GUARNIZIONE "VITON 90SH" GASKET "VITON 90SH"	1
H302	RONDELLA IN "PTFE" WASHER "PTFE"	1
H371	O-RING 2037 "VITON" O-RING 2037 "VITON"	1
H394	RONDELLA IN "PTFE" WASHER "PTFE"	1



Art. 8432.100 Mod. 432-20 bar - Art. 8432.500 Mod. 432-600 bar
 Art. 8434.200 Mod. 434-100 bar - Art. 8434.300 Mod. 434-200 bar
 Art. 8434.350 Mod. 434-400 bar



VISTA ESPLOSA - EXPLODED VIEW

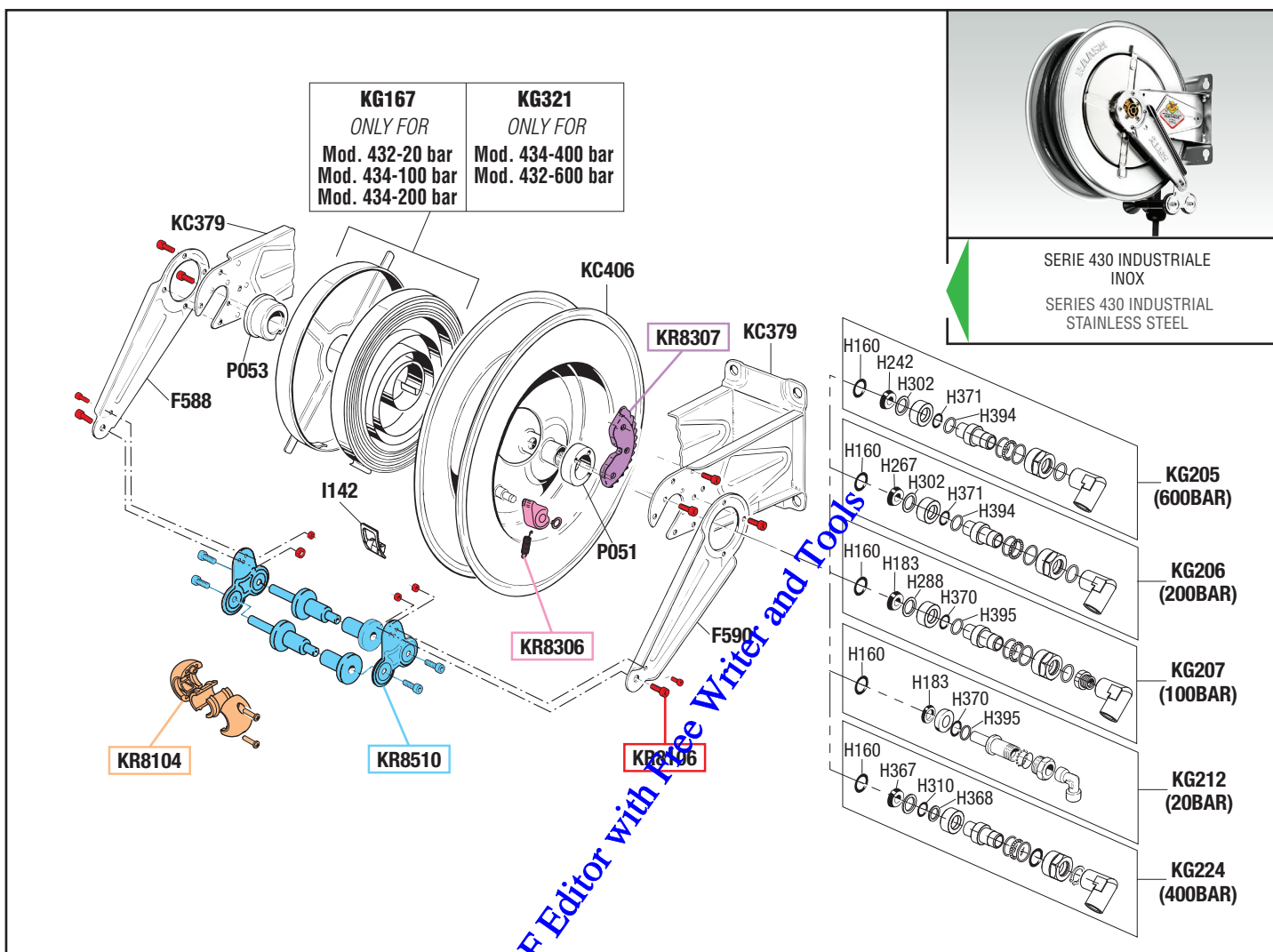

GUIDA RICAMBI - SPARE PARTS GUIDE

KIT RICAMBI
 OGNI KIT SOTTO RIPORTATO COMPRENDE I RICAMBI EVIDENZIATI CON LO STESSO COLORE E LE RELATIVE GUARNIZIONI. QUESTI RICAMBI NON SONO FORNIBILI SEPARATAMENTE TRANNE QUELLI CODIFICATI.

SPARE PARTS KITS
 EACH KIT SHOWN WITH THE SAME COLOR INCLUDES ALSO THE GASKETS. THE SPARE PARTS INCLUDED IN THE KIT CAN'T BE SUPPLIED SEPARATELY EXCEPT THOSE SHOWN WITH A PROPER CODE.

CODICE CODE	DESCRIZIONE DESCRIPTION	Q.TÀ QTY
KR8104	TAMPONE FERMATUBO HOSE STOP	1
KR8106	SET VITI ARROTOLATORE SET OF SCREWS FOR HOSEREEL	1
KR8306	DENTE D'ARRESTO DETENT	1
KR8307	KIT CREMAGLIERA RACK KIT	1
KR8510	KIT PORTA RULLI ARROTOLATORE ROLLERS HOLDING KIT FOR HOSEREEL	1

ELENCO RICAMBI FORNIBILI SINGOLARMENTE
 LIST OF SPARE PARTS WHICH CAN BE SUPPLIED SEPARATELY

CODICE CODE	DESCRIZIONE DESCRIPTION	Q.TÀ QTY
F588	BRACCIO ORIENTABILE SWINGING ARM	1
F590	BRACCIO ORIENTABILE SWINGING ARM	1
I142	INSERTO USCITA TUBO HOSE OUTLET PROTECTION	1
KC379	STAFFA BRACKET	1
KC406	TAMBURO 420 420 HOSEREEL DRUM	1
KG167	CARTER-MOLLA COVER SPRING-GROUP	1
KG205	SNODO GRASSO 600 BAR JOINT GREASE 600 BAR	1
KG206	SNODO ACQUA 200 BAR JOINT WATER 200 BAR	1
KG207	SNODO ACQUA 100 BAR JOINT WATER 100 BAR	1
KG212	SNODO ARIA-ACQUA 20 BAR JOINT AIR-WATER 20 BAR	1
KG224	SNODO ACQUA 400 BAR JOINT WATER 400 BAR	1
KG321	CARTER-MOLLA (Art.8434.350-8432.500) COVER SPRING-GROUP (Art.8434.350-8432.500)	1
P051	BOCCOLA LATO CREMAGLIERA BUSH	1
P053	BOCCOLA LATO MOLLA BUSH	1

ELENCO GUARNIZIONI SNODI
 JOINTS GASKETS LIST

CODICE CODE	DESCRIZIONE DESCRIPTION	Q.TÀ QTY
H160	O-RING 2093 O-RING 2093	1
H183	GUARNIZIONE GASKET	1
H242	GUARNIZIONE M4 1810-PUR95 GASKET	1
H267	GUARNIZIONE VITON 90SH GASKET	1
H288	RONDELLA IN PTFE PTFE WASHER	1
H302	RONDELLA IN PTFE PTFE WASHER	1
H310	GUARNIZIONE OR 112 VITON GASKET	1
H367	GUARNIZIONE GASKET	1
H368	RONDELLA IN PTFE PTFE WASHER	1
H370	GUARNIZIONE OR 2062 VITON GASKET	1
H371	GUARNIZIONE OR 2037 VITON GASKET	1
H394	RONDELLA IN PTFE PTFE WASHER	1
H395	RONDELLA IN PTFE PTFE WASHER	1

tutti i diritti riservati - all rights reserved



Art. 8432.700 Mod. 432 BIN



VISTA ESPLOSA - EXPLODED VIEW

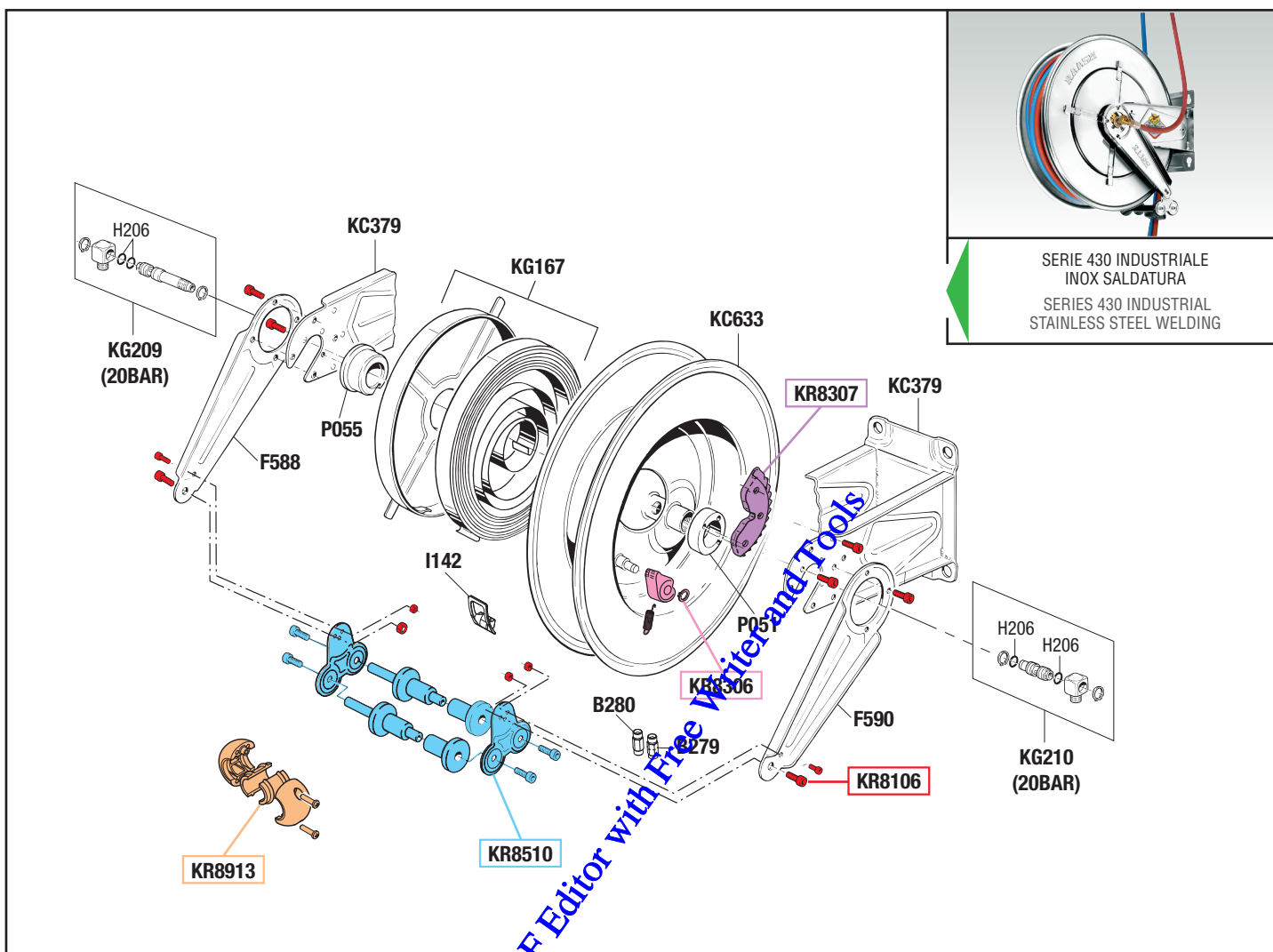

tutti i diritti riservati - all rights reserved

GUIDA RICAMBI - SPARE PARTS GUIDE

KIT RICAMBI
OGNI KIT SOTTO RIPORTATO COMPRENDE I RICAMBI EVIDENZIATI CON LO STESSO COLORE E LE RELATIVE GUARNIZIONI. QUESTI RICAMBI NON SONO FORNIBILI SEPARATAMENTE TRANNE QUELLI CODIFICATI.

SPARE PARTS KITS
EACH KIT SHOWN WITH THE SAME COLOR INCLUDES ALSO THE GASKETS. THE SPARE PARTS INCLUDED IN THE KIT CAN'T BE SUPPLIED SEPARATELY EXCEPT THOSE SHOWN WITH A PROPER CODE.

CODICE CODE	DESCRIZIONE DESCRIPTION	Q.TÀ QTY
KR8106	SET VITI ARROTOLATORE SET OF SCREWS FOR HOSE REEL	1
KR8306	DENTE D'ARRESTO DETENT	1
KR8307	KIT CREMAGLIERA RACK KIT	1
KR8510	KIT PORTA RULLI ARROTOLATORE ROLLERS HOLDING KIT FOR HOSE REEL	1
KR8913	TAMPONE FERMATUBO HOSE STOP	1

ELENCO RICAMBI FORNIBILI SINGOLARMENTE
LIST OF SPARE PARTS WHICH CAN BE SUPPLIED SEPARATELY

CODICE CODE	DESCRIZIONE DESCRIPTION	Q.TÀ QTY
B279	NIPPES SINISTRO LEFT ADAPTOR	1
B280	NIPPES DESTRO RIGHT ADAPTOR	1
F588	BRACCIO ORIENTABILE SWINGING ARM	1
F590	BRACCIO ORIENTABILE SWINGING ARM	1
I142	INSERTO USCITA TUBO HOSE OUTLET PROTECTION	1
KC379	STAFFA BRACKET	1
KC633	TAMBURO DRUM	1
KG167	CARTER-MOLLA COVER SPRING-GROUP	1
KG209	SNODO SINISTRO 20 BAR LEFT JOINT 20 BAR	1
KG210	SNODO DESTRO 20 BAR RIGHT JOINT 20 BAR	1
P051	BOCCOLA LATO CREMAGLIERA BUSH	1
P055	BOCCOLA LATO MOLLA BUSH	1

ELENCO GUARNIZIONI SNODI
JOINTS GASKETS LIST

CODICE CODE	DESCRIZIONE DESCRIPTION	Q.TÀ QTY
H206	O-RING 3043 "VITON" O-RING 3043 "VITON"	4



Art. 8432.800 Mod. 432 GAS

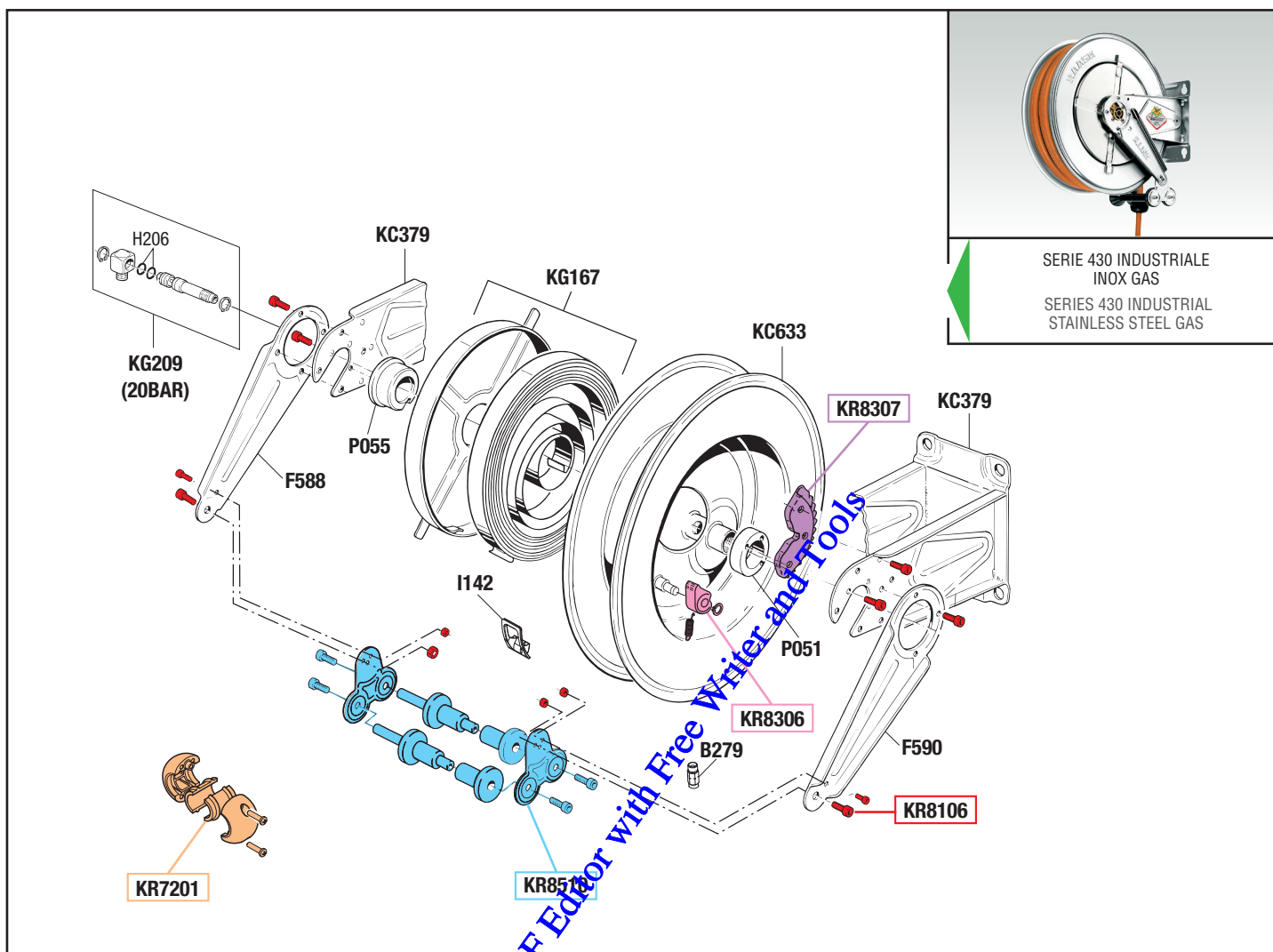

VISTA ESPLOSA - EXPLODED VIEW

SERIE 430 INDUSTRIALE
INOX GASSERIES 430 INDUSTRIAL
STAINLESS STEEL GAS

GUIDA RICAMBI - SPARE PARTS GUIDE

KIT RICAMBI

OGNI KIT SOTTO RIPORTATO COMPRENDE I RICAMBI EVIDENZIATI CON LO STESSO COLORE E LE RELATIVE GUARNIZIONI. QUESTI RICAMBI NON SONO FORNIBILI SEPARATAMENTE TRANNE QUELLI CODIFICATI.

SPARE PARTS KITS

EACH KIT SHOWN WITH THE SAME COLOR INCLUDES ALSO THE GASKETS. THE SPARE PARTS INCLUDED IN THE KIT CAN'T BE SUPPLIED SEPARATELY EXCEPT THOSE SHOWN WITH A PROPER CODE.

CODICE CODE	DESCRIZIONE DESCRIPTION	Q.TÀ QTY
KR7201	TAMPONE FERMATUBO HOSE STOP	1
KR8106	SET VITI ARROTOLATORE SET OF SCREWS FOR HOSE REEL	1
KR8306	DENTE D'ARRESTO DETENT	1
KR8307	KIT CREMAGLIERA RACK KIT	1
KR8510	KIT PORTA RULLI ARROTOLATORE ROLLERS HOLDING KIT FOR HOSE REEL	1

ELENCO RICAMBI FORNIBILI SINGOLARMENTE

LIST OF SPARE PARTS WHICH CAN BE SUPPLIED SEPARATELY

CODICE CODE	DESCRIZIONE DESCRIPTION	Q.TÀ QTY
B279	NIPPES SINISTRO LEFT ADAPTOR	1
F588	BRACCIO ORIENTABILE SWINGING ARM	1
F590	BRACCIO ORIENTABILE SWINGING ARM	1
I142	INSERTO USCITA TUBO HOSE OUTLET PROTECTION	1
KC379	STAFFA BRACKET	1
KC633	TAMBURO DRUM	1
KG167	CARTER-MOLLA COVER SPRING-GROUP	1
KG209	SNODO SINISTRO 20 BAR LEFT JOINT 20 BAR	1
P051	BOCCOLA LATO CREMAGLIERA BUSH	1
P055	BOCCOLA LATO MOLLA BUSH	1

ELENCO GUARNIZIONI SNODI

JOINTS GASKETS LIST

CODICE CODE	DESCRIZIONE DESCRIPTION	Q.TÀ QTY
H206	O-RING 3043 "VITON" O-RING 3043 "VITON"	2

tutti i diritti riservati - all rights reserved



Art. 8436.200 Mod. 436-S316L-100 bar - ADB



VISTA ESPLOSA - EXPLODED VIEW

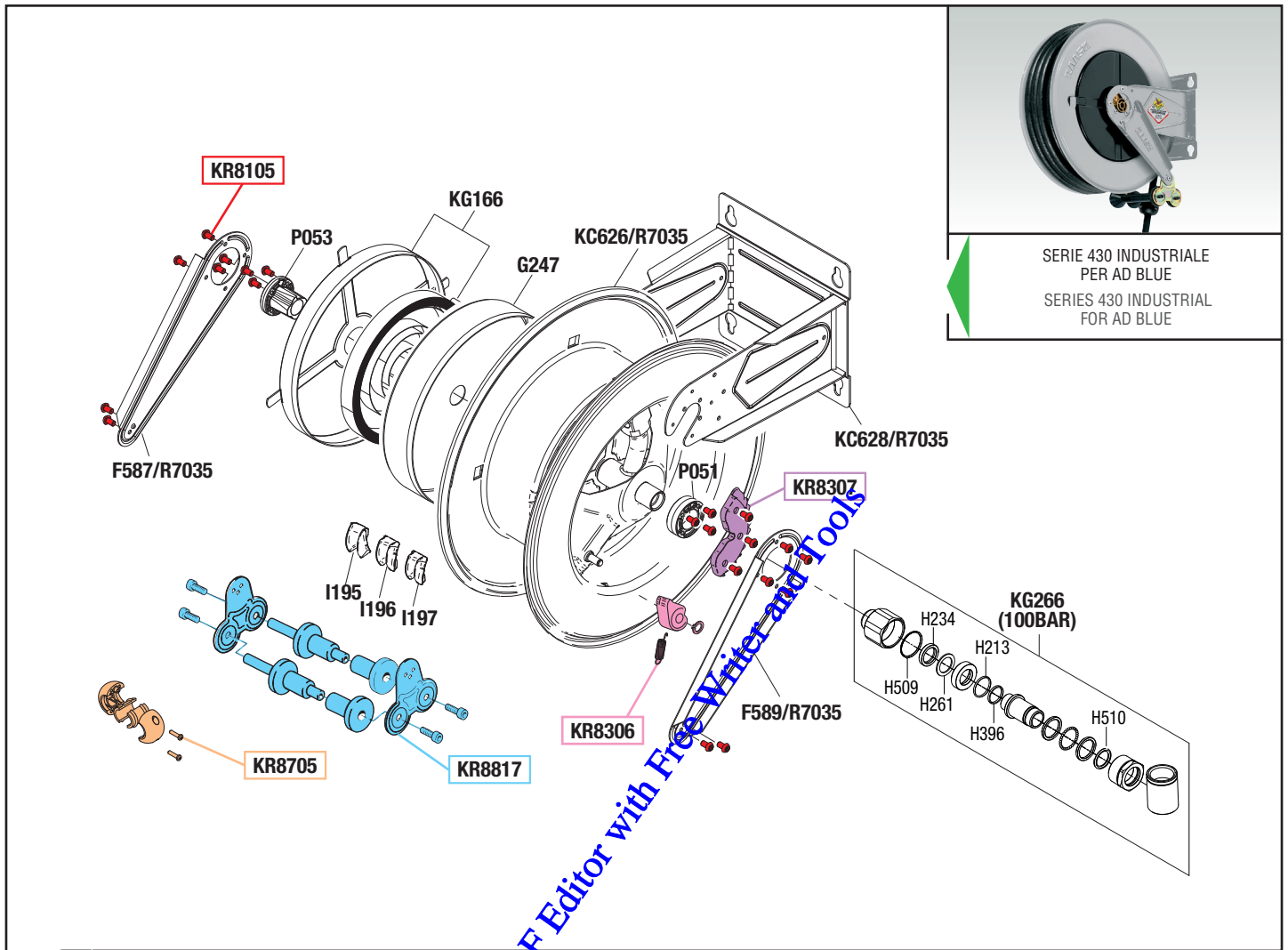

tutti i diritti riservati - all rights reserved

GUIDA RICAMBI - SPARE PARTS GUIDE

KIT RICAMBI

OGNI KIT SOTTO RIPORTATO COMPRENDE I RICAMBI EVIDENZIATI CON LO STESSO COLORE E LE RELATIVE GUARNIZIONI. QUESTI RICAMBI NON SONO FORNIBILI SEPARATAMENTE TRANNE QUELLI CODIFICATI.

SPARE PARTS KITS

EACH KIT SHOWN WITH THE SAME COLOR INCLUDES ALSO THE GASKETS. THE SPARE PARTS INCLUDED IN THE KIT CAN'T BE SUPPLIED SEPARATELY EXCEPT THOSE SHOWN WITH A PROPER CODE.

CODICE CODE	DESCRIZIONE DESCRIPTION	Q.TÀ QTY
KR8105	SET VITI ARROTOLATORE SET OF SCREWS FOR HOSEREEL	1
KR8306	DENTE D'ARRESTO DETENT	1
KR8307	KIT CREMAGLIERA RACK KIT	1
KR8705	TAMPONE FERMATUBO HOSE STOP	1
KR8817	KIT PORTA RULLI ARROTOLATORE ROLLERS HOLDING KIT FOR HOSEREEL	1

ELENCO RICAMBI FORNIBILI SINGOLARMENTE

LIST OF SPARE PARTS WHICH CAN BE SUPPLIED SEPARATELY

CODICE CODE	DESCRIZIONE DESCRIPTION	Q.TÀ QTY
F587/R7035	BRACCIO ORIENTABILE SWINGING ARM	1
F589/R7035	BRACCIO ORIENTABILE SWINGING ARM	1
G247	DISTANZIATORE SPACER	1
I195	INSERTO FORO USCITA TUBO Ø 34-38 HOSE OUTLET PROTECTION Ø 34-38	1
I196	INSERTO FORO USCITA TUBO Ø 30-34 HOSE OUTLET PROTECTION Ø 30-34	1
I197	INSERTO FORO USCITA TUBO Ø 26-30 HOSE OUTLET PROTECTION Ø 26-30	1
KC626/R7035	TAMBURO 420 420 HOSEREEL DRUM	1
KC628/R7035	SUPPORTO AVVOLGITUBO HOSEREEL SUPPORT	1
KG166	CARTER-MOLLA COVER-SPRING GROUP	1
KG266	SNODO INOX AISI 316L - 100 BAR AISI 316L S.STEEL HOSEREEL JOINT- 100 BAR	1
P051	BOCCOLA LATO CREMAGLIERA BUSH	1
P053	BOCCOLA LATO MOLLA BUSH	1

ELENCO GUARNIZIONI SNODI

JOINTS GASKETS LIST

CODICE CODE	DESCRIZIONE DESCRIPTION	Q.TÀ QTY
H213	OR 2087 VITON	1
H234	GUARNIZIONE VITON GASKET	1
H261	RONDELLA WASHER	1
H396	RONDELLA WASHER	1
H509	OR 2131 VITON OR 2131 VITON	1
H510	OR 2106 VITON OR 2106 VITON	1



Art. 8437.250 Mod. 437-S316L-100 bar



VISTA ESPLOSA - EXPLODED VIEW

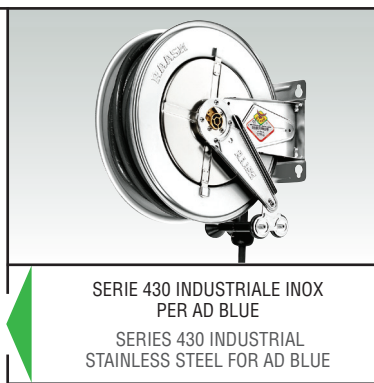
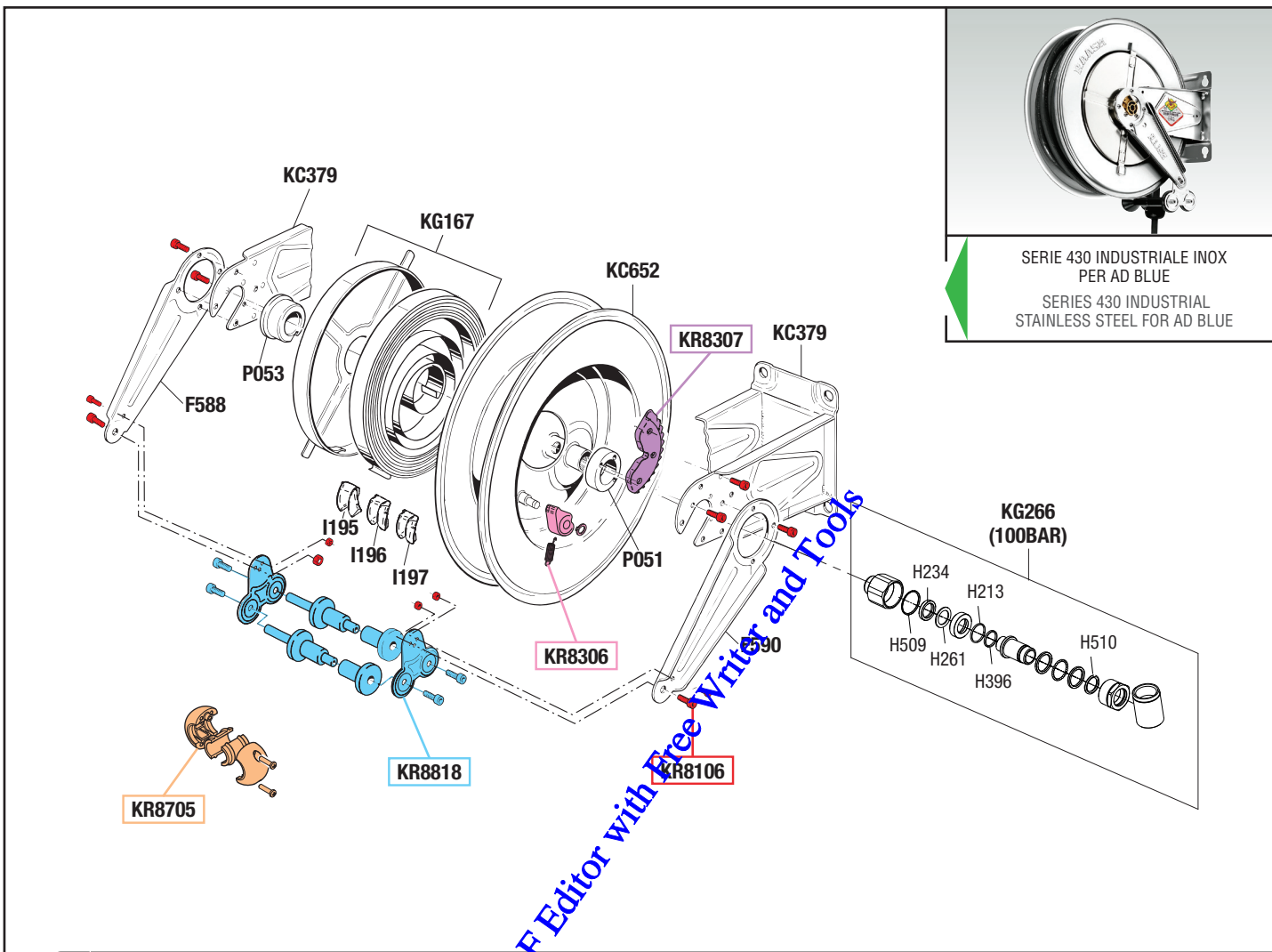

GUIDA RICAMBI - SPARE PARTS GUIDE

KIT RICAMBI
OGNI KIT SOTTO RIPORTATO COMPRENDE I RICAMBI EVIDENZIATI CON LO STESSO COLORE E LE RELATIVE GUARNIZIONI. QUESTI RICAMBI NON SONO FORNIBILI SEPARATAMENTE TRANNE QUELLI CODIFICATI.

SPARE PARTS KITS
EACH KIT SHOWN WITH THE SAME COLOR INCLUDES ALSO THE GASKETS. THE SPARE PARTS INCLUDED IN THE KIT CAN'T BE SUPPLIED SEPARATELY EXCEPT THOSE SHOWN WITH A PROPER CODE.

CODICE CODE	DESCRIZIONE DESCRIPTION	Q.TÀ QTY
KR8106	SET VITI ARROTOLATORE SET OF SCREWS FOR HOSEREEL	1
KR8306	DENTE D'ARRESTO DETENT	1
KR8307	KIT CREMAGLIERA RACK KIT	1
KR8705	TAMPONE FERMATUBO HOSE STOP	1
KR8818	KIT PORTA RULLI ARROTOLATORE ROLLERS HOLDING KIT FOR HOSEREEL	1

ELENCO RICAMBI FORNIBILI SINGOLARMENTE
LIST OF SPARE PARTS WHICH CAN BE SUPPLIED SEPARATELY

CODICE CODE	DESCRIZIONE DESCRIPTION	Q.TÀ QTY
F588	BRACCIO ORIENTABILE SWINGING ARM	1
F590	BRACCIO ORIENTABILE SWINGING ARM	1
I195	INSERTO FORO USCITA TUBO Ø 34-38 HOSE OUTLET PROTECTION Ø 34-38	1
I196	INSERTO FORO USCITA TUBO Ø 30-34 HOSE OUTLET PROTECTION Ø 30-34	1
I197	INSERTO FORO USCITA TUBO Ø 26-30 HOSE OUTLET PROTECTION Ø 26-30	1
KC379	STAFFA BRACKET	1
KC652	TAMBURO 420 420 HOSEREEL DRUM	1
KG167	CARTER-MOLLA COVER SPRING-GROUP	1
KG266	SNODO INOX AISI 316L AISI 316L S. STEEL HOSEREEL JOINT	1
P051	BOCCOLA LATO CREMAGLIERA BUSH	1
P053	BOCCOLA LATO MOLLA BUSH	1

ELENCO GUARNIZIONI SNODI
JOINTS GASKETS LIST

CODICE CODE	DESCRIZIONE DESCRIPTION	Q.TÀ QTY
H213	O-RING 2087 VITON O-RING 2087 VITON	1
H234	GUARNIZIONE VITON GASKET	1
H261	RONDELLA WASHER	1
H396	RONDELLA WASHER	1
H509	O-RING 2131 VITON O-RING 2131 VITON	1
H510	O-RING 2106 VITON O-RING 2106 VITON	1

tutti i diritti riservati - all rights reserved



Art. 8440.100 Mod. 440-20 bar - Art. 8440.400 Mod. 440-150 bar
 Art. 8440.500 Mod. 440-600 bar

VISTA ESPLOSA - EXPLODED VIEW

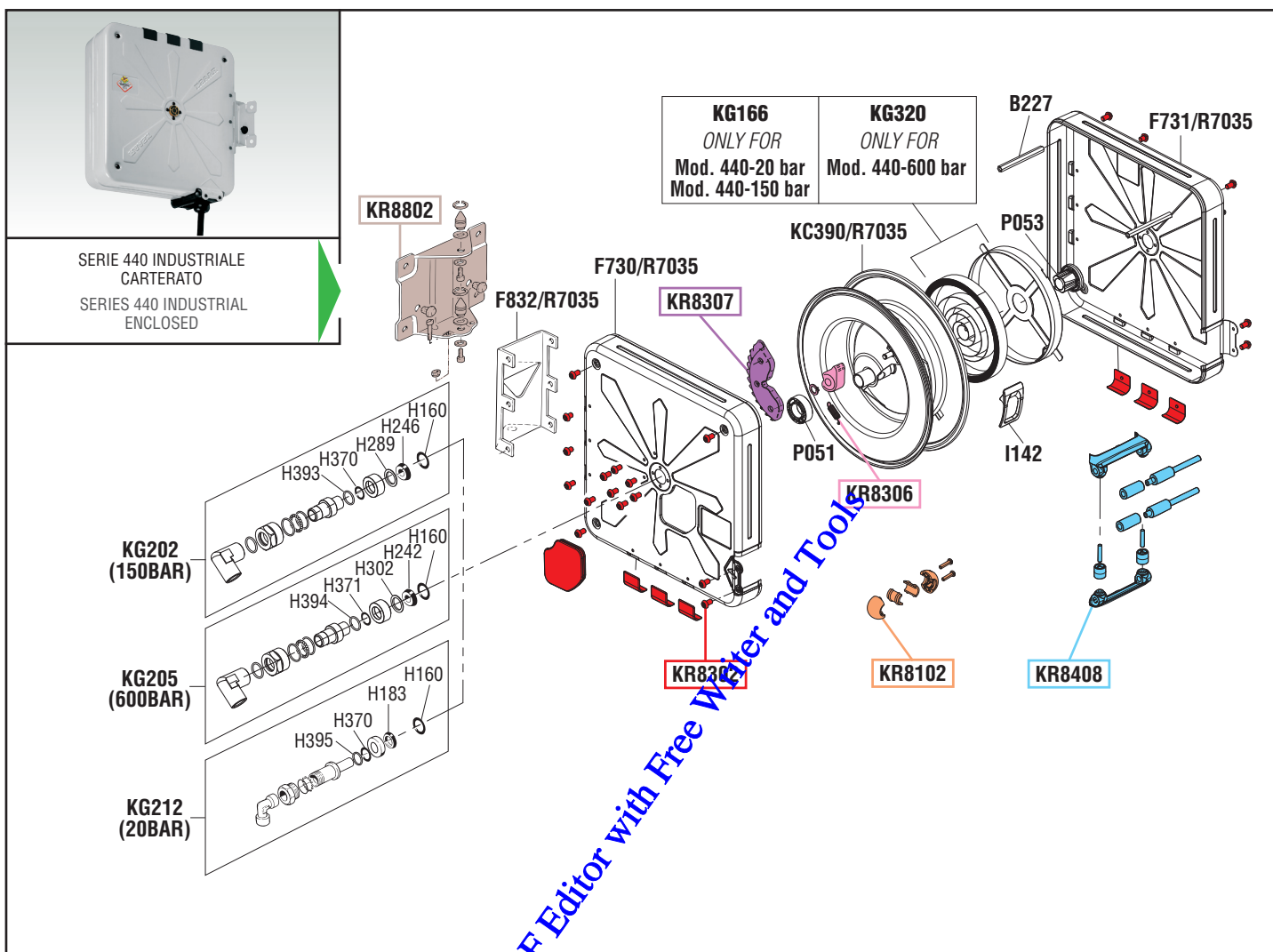

tutti i diritti riservati - all rights reserved

GUIDA RICAMBI - SPARE PARTS GUIDE

KIT RICAMBI
 OGNI KIT SOTTO RIPORTATO COMPRENDE I RICAMBI EVIDENZIATI CON LO STESSO COLORE E LE RELATIVE GUARNIZIONI. QUESTI RICAMBI NON SONO FORNIBILI SEPARATAMENTE TRANNE QUELLI CODIFICATI.

SPARE PARTS KITS
 EACH KIT SHOWN WITH THE SAME COLOR INCLUDES ALSO THE GASKETS. THE SPARE PARTS INCLUDED IN THE KIT CAN'T BE SUPPLIED SEPARATELY EXCEPT THOSE SHOWN WITH A PROPER CODE.

CODICE CODE	DESCRIZIONE DESCRIPTION	Q.TÀ QTY
KR8102	TAMPONE FERMATUBO HOSE STOP	1
KR8302	SET VITI AVVOLGITUBO HOSEREEL SCREWS KIT	1
KR8306	DENTE D'ARRESTO DETENT	1
KR8307	KIT CREMAGLIERA RACK KIT	1
KR8408	KIT PORTA RULLI AVVOLGITUBO ROLLERS HOLDING KIT FOR HOSEREEL	1
KR8802	STAFFA PER AVVOLGITUBO WALL MOUNTED BRACKET FOR HOSEREEL	1

ELENCO RICAMBI FORNIBILI SINGOLARMENTE
 LIST OF SPARE PARTS WHICH CAN BE SUPPLIED SEPARATELY

CODICE CODE	DESCRIZIONE DESCRIPTION	Q.TÀ QTY
B227	PRIGIONIERO SLEEVE	2
F730/R7035	CARTER LATO CREMAGLIERA RACK SIDE COVER	1
F731/R7035	CARTER LATO MOLLA SPRING SIDE COVER	1
F832/R7035	STAFFA ORIENTABILE SWIVELLING BRACKET	1
I142	INSERTO FORO USCITA TUBO HOSE OUTLET PROTECTION	1
KC390/R7035	TAMBURO AVVOLGITUBO HOSEREEL DRUM	1
KG166	CARTER MOLLA COVER SPRING GROUP	1
KG202	SNODO OLIO 150 BAR JOINT OIL 150 BAR	1
KG205	SNODO GRASSO 600 BAR JOINT GREASE 600 BAR	1
KG212	SNODO ARIA-ACQUA 20 BAR JOINT AIR-WATER 20 BAR	1
KG320	CARTER MOLLA (Art. 8440.500) COVER SPRING GROUP (Art. 8440.500)	1
P051	BOCCOLA LATO CREMAGLIERA RACK SIDE BUSH	1
P053	BOCCOLA LATO MOLLA SPRING SIDE BUSH	1

ELENCO GUARNIZIONI SNODI
 JOINTS GASKETS LIST

CODICE CODE	DESCRIZIONE DESCRIPTION	Q.TÀ QTY
H160	O-RING 2093 O-RING 2093	1
H183	GUARNIZIONE GASKET	1
H242	GUARNIZIONE GASKET	1
H246	GUARNIZIONE GASKET	1
H289	RONDELLA IN "PTFE" WASHER "PTFE"	1
H302	RONDELLA IN "PTFE" WASHER "PTFE"	1
H370	O-RING 2062 "VITON" O-RING 2062 "VITON"	1
H371	O-RING 2037 "VITON" O-RING 2037 "VITON"	1
H393	RONDELLA IN "PTFE" WASHER "PTFE"	1
H394	RONDELLA IN "PTFE" WASHER "PTFE"	1
H395	RONDELLA IN "PTFE" WASHER "PTFE"	1



Art. 8450.100 Mod. 450-20 bar - Art. 8450.400 Mod. 450-150 bar
 Art. 8450.500 Mod. 450-600 bar



VISTA ESPLOSA - EXPLODED VIEW

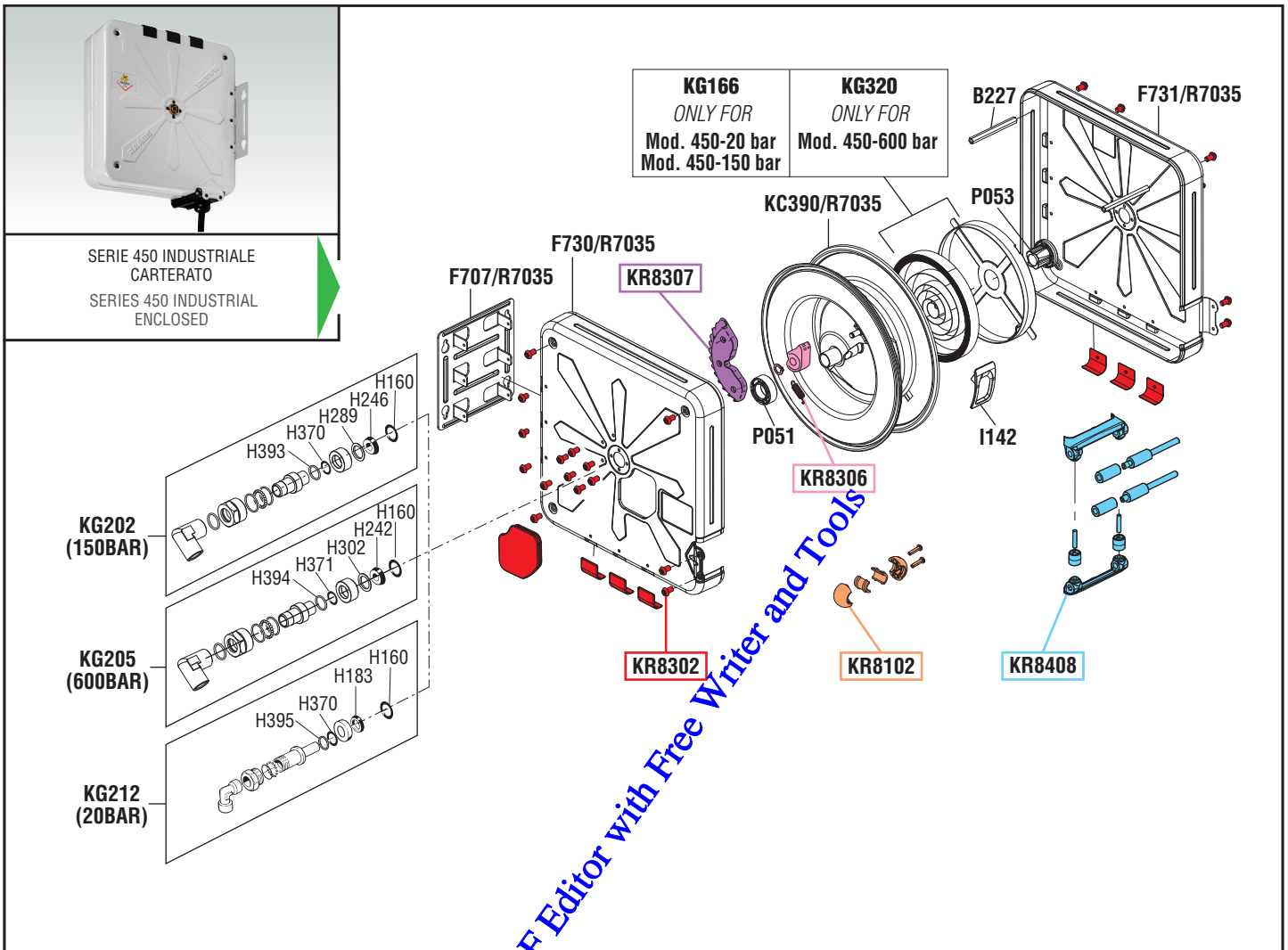

GUIDA RICAMBI - SPARE PARTS GUIDE

KIT RICAMBI
 OGNI KIT SOTTO RIPORTATO COMPRENDE I RICAMBI EVIDENZIATI CON LO STESSO COLORE E LE RELATIVE GUARNIZIONI. QUESTI RICAMBI NON SONO FORNIBILI SEPARATAMENTE TRANNE QUELLI CODIFICATI.

SPARE PARTS KITS
 EACH KIT SHOWN WITH THE SAME COLOR INCLUDES ALSO THE GASKETS. THE SPARE PARTS INCLUDED IN THE KIT CAN'T BE SUPPLIED SEPARATELY EXCEPT THOSE SHOWN WITH A PROPER CODE.

CODICE CODE	DESCRIZIONE DESCRIPTION	Q.TÀ QTY
KR8102	TAMPONE FERMATUBO HOSE STOP	1
KR8302	SET VITI AVVOLGITUBO HOSEREEL SCREWS KIT	1
KR8306	DENTE D'ARRESTO DETENT	1
KR8307	KIT CREMAGLIERA RACK KIT	1
KR8408	KIT PORTA RULLI AVVOLGITUBO ROLLERS HOLDING KIT FOR HOSEREEL	1

ELENCO RICAMBI FORNIBILI SINGOLARMENTE
 LIST OF SPARE PARTS WHICH CAN BE SUPPLIED SEPARATELY

CODICE CODE	DESCRIZIONE DESCRIPTION	Q.TÀ QTY
B227	PRIGIONIERO SLEEVE	2
F707/R7035	STAFFA BRACKET	1
F730/R7035	CARTER LATO CREMAGLIERA RACK SIDE COVER	1
F731/R7035	CARTER LATO MOLLA SPRING SIDE COVER	1
I142	INSERTO FORO USCITA TUBO HOSE OUTLET PROTECTION	1
KC390/R7035	TAMBURO AVVOLGITUBO HOSEREEL DRUM	1
KG166	CARTER MOLLA COVER SPRING GROUP	1
KG202	SNODO OLIO 150 BAR JOINT OIL 150 BAR	1
KG205	SNODO GRASSO 600 BAR JOINT GREASE 600 BAR	1
KG212	SNODO ARIA-ACQUA 20 BAR JOINT AIR-WATER 20 BAR	1
KG320	CARTER MOLLA (Art. 8450.500) COVER SPRING GROUP (Art. 8450.500)	1
P051	BOCCOLA LATO CREMAGLIERA RACK SIDE BUSH	1
P053	BOCCOLA LATO MOLLA SPRING SIDE BUSH	1

ELENCO GUARNIZIONI SNODI
 JOINTS GASKETS LIST

CODICE CODE	DESCRIZIONE DESCRIPTION	Q.TÀ QTY
H160	O-RING 2093 O-RING 2093	1
H183	GUARNIZIONE GASKET	1
H242	GUARNIZIONE GASKET	1
H246	GUARNIZIONE GASKET	1
H289	RONDELLA IN "PTFE" WASHER "PTFE"	1
H302	RONDELLA IN "PTFE" WASHER "PTFE"	1
H370	O-RING 2062 "VITON" O-RING 2062 "VITON"	1
H371	O-RING 2037 "VITON" O-RING 2037 "VITON"	1
H393	RONDELLA IN "PTFE" WASHER "PTFE"	1
H394	RONDELLA IN "PTFE" WASHER "PTFE"	1
H395	RONDELLA IN "PTFE" WASHER "PTFE"	1

tutti i diritti riservati - all rights reserved



Art. 8520.100 Mod. 520-20 bar - Art. 8520.200 Mod. 520-100 bar
 Art. 8520.300 Mod. 520-200 bar - Art. 8520.350 Mod. 520-400 bar
 Art. 8520.400 Mod. 520-150 bar - Art. 8520.500 Mod. 520-600 bar



VISTA ESPLOSA - EXPLODED VIEW

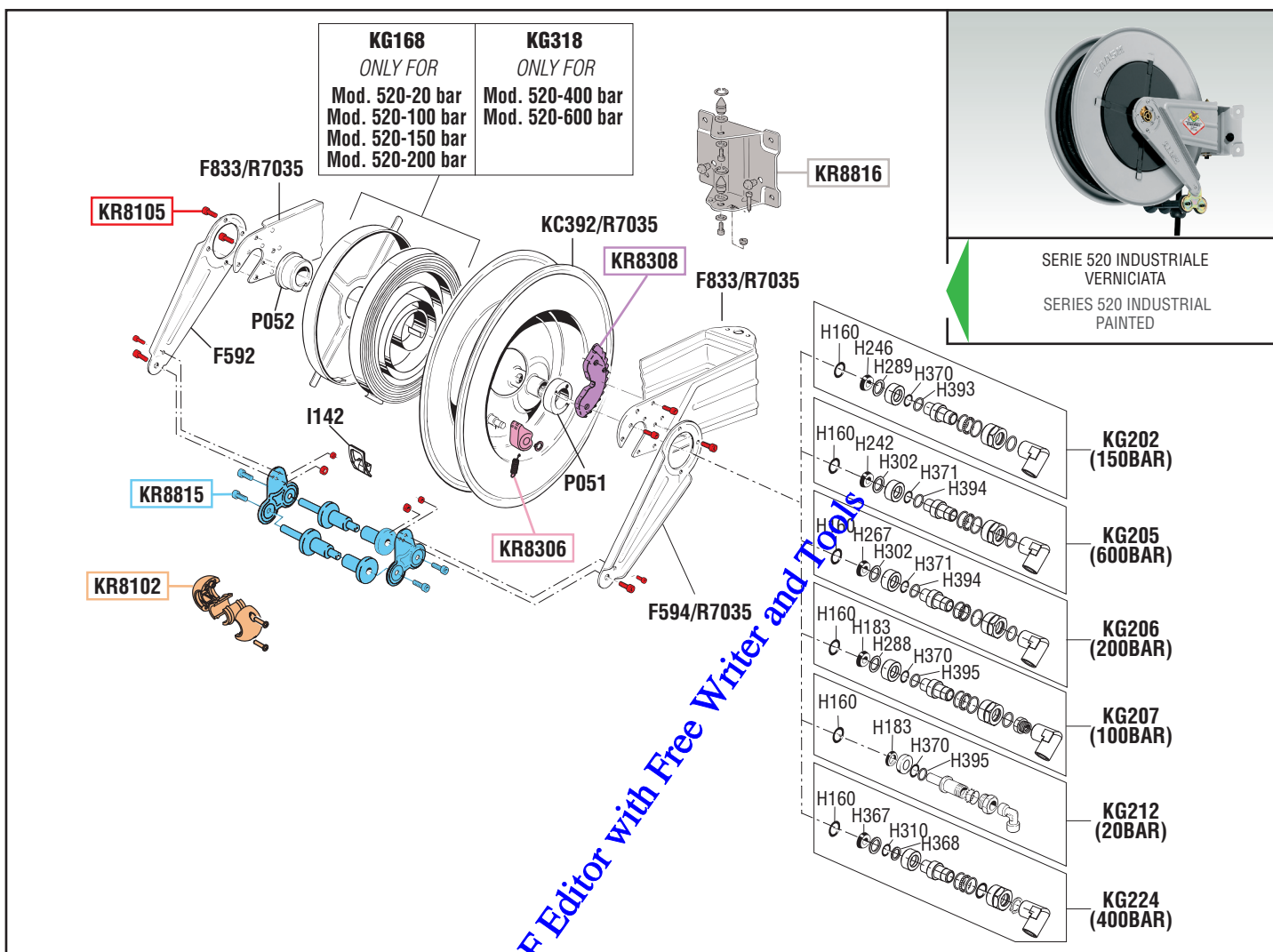

tutti i diritti riservati - all rights reserved

GUIDA RICAMBI - SPARE PARTS GUIDE

KIT RICAMBI
 OGNI KIT SOTTO RIPORTATO COMPRENDE I RICAMBI EVIDENZIATI CON LO STESSO COLORE E LE RELATIVE GUARNIZIONI. QUESTI RICAMBI NON SONO FORNIBILI SEPARATAMENTE TRANNE QUELLI CODIFICATI.

SPARE PARTS KITS
 EACH KIT SHOWN WITH THE SAME COLOR INCLUDES ALSO THE GASKETS. THE SPARE PARTS INCLUDED IN THE KIT CAN'T BE SUPPLIED SEPARATELY EXCEPT THOSE SHOWN WITH A PROPER CODE.

CODICE CODE	DESCRIZIONE DESCRIPTION	Q.TÀ QTY
KR8102	TAMPONE FERMATUBO HOSE STOP	1
KR8105	SET VITI AVVOLGITUBO SET OF SCREWS FOR HOSEREEL	1
KR8306	DENTE D'ARRESTO DETENT	1
KR8308	KIT CREMAGLIERA RACK KIT	1
KR8815	KIT PORTA RULLI AVVOLGITUBO ROLLERS HOLDING KIT FOR HOSEREEL	1
KR8816	STAFFA PER AVVOLGITUBO WALL MOUNTED BRACKET FOR HOSEREEL	1

ELENCO RICAMBI FORNIBILI SINGOLARMENTE
 LIST OF SPARE PARTS WHICH CAN BE SUPPLIED SEPARATELY

CODICE CODE	DESCRIZIONE DESCRIPTION	Q.TÀ QTY
F592/R7035	BRACCIO ORIENTABILE ADJUSTABLE ARM	1
F594/R7035	BRACCIO ORIENTABILE ADJUSTABLE ARM	1
F833/R7035	STAFFA ORIENTABILE SWIVELLING BRACKET	1
I142	INSERTO FORO USCITA TUBO HOSE OUTLET PROTECTION	1
KC392/R7035	TAMBURO AVVOLGITUBO HOSEREEL DRUM	1
KG168	CARTER MOLLA COVER SPRING GROUP	1
KG202	SNODO OLIO 150 BAR JOINT OIL 150 BAR	1
KG205	SNODO GRASSO 600 BAR JOINT GREASE 600 BAR	1
KG206	SNODO ACQUA 200 BAR JOINT WATER 200 BAR	1
KG207	SNODO ACQUA 100 BAR JOINT WATER 100 BAR	1
KG212	SNODO ARIA-ACQUA 20 BAR JOINT AIR-WATER 20 BAR	1
KG224	SNODO ACQUA 400 BAR JOINT WATER 400 BAR	1
KG318	CARTER MOLLA (Art.8520.350-8520.500) COVER SPRING GROUP (Art.8520.350-8520.500)	1
P051	BOCCOLA LATO CREMAGLIERA ROLLER SIDE BUSH	1
P052	BOCCOLA LATO MOLLA SPRING SIDE BUSH	1

ELENCO GUARNIZIONI SNODI
 JOINTS GASKETS LIST

CODICE CODE	DESCRIZIONE DESCRIPTION	Q.TÀ QTY
H160	O-RING 2093 O-RING 2093	1
H183	GUARNIZIONE GASKET	1
H242	GUARNIZIONE GASKET	1
H246	GUARNIZIONE GASKET	1
H267	GUARNIZIONE "VITON 90SH" GASKET "VITON 90SH"	1
H288	RONDELLA IN "PTFE" WASHER "PTFE"	1
H289	RONDELLA IN "PTFE" WASHER "PTFE"	1
H302	RONDELLA IN "PTFE" WASHER "PTFE"	1
H310	O-RING 112 "VITON" O-RING 112 "VITON"	1
H367	GUARNIZIONE GASKET	1
H368	RONDELLA IN "PTFE" WASHER "PTFE"	1
H370	O-RING 2062 "VITON" O-RING 2062 "VITON"	1
H371	O-RING 2037 "VITON" O-RING 2037 "VITON"	1
H393	RONDELLA IN "PTFE" WASHER "PTFE"	1
H394	RONDELLA IN "PTFE" WASHER "PTFE"	1
H395	RONDELLA IN "PTFE" WASHER "PTFE"	1



Art. 8520.700 Mod. 520 BIN



VISTA ESPLOSA - EXPLODED VIEW

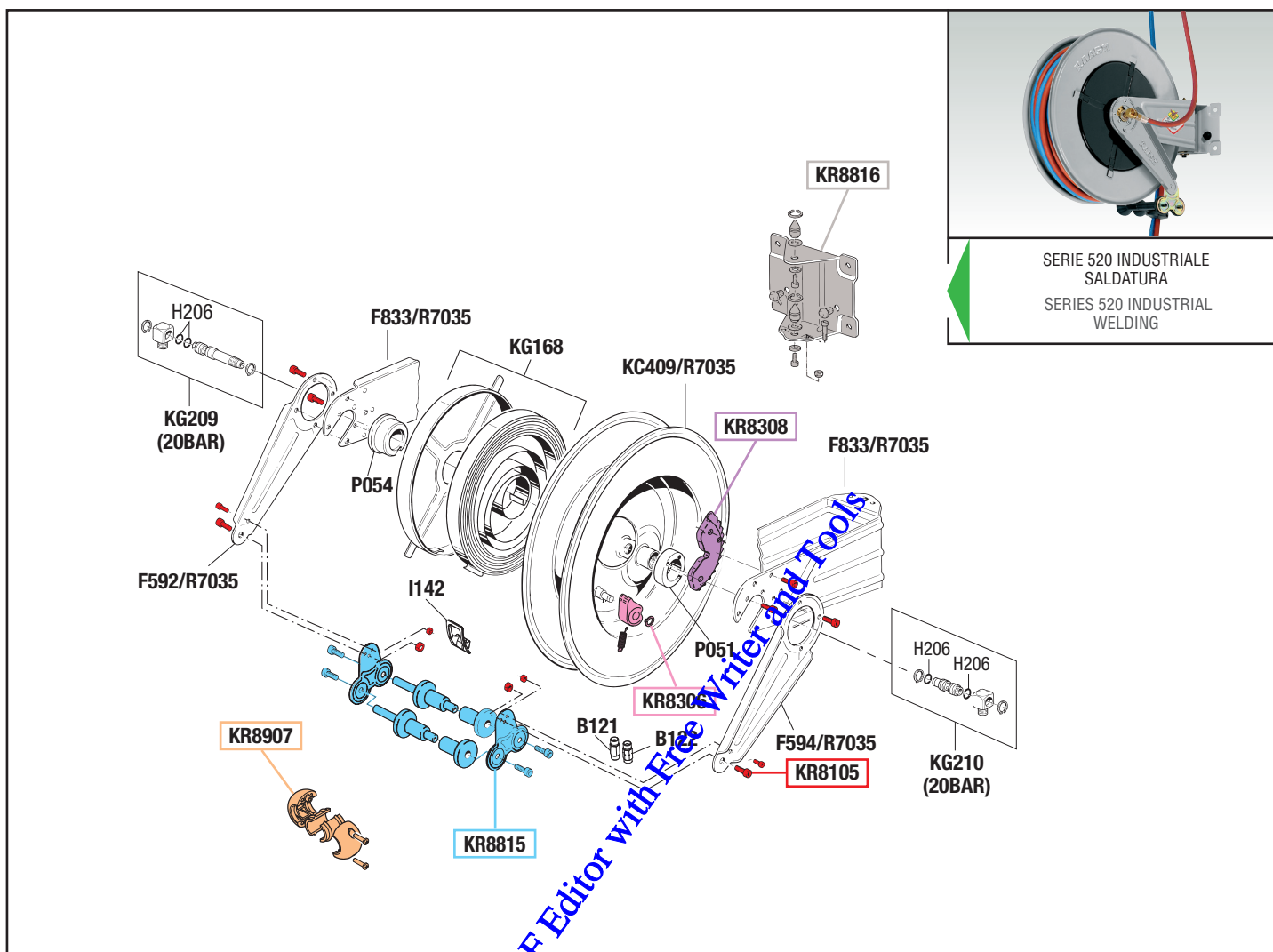

tutti i diritti riservati - all rights reserved

GUIDA RICAMBI - SPARE PARTS GUIDE

KIT RICAMBI

OGNI KIT SOTTO RIPORTATO COMPRENDE I RICAMBI EVIDENZIATI CON LO STESSO COLORE E LE RELATIVE GUARNIZIONI. QUESTI RICAMBI NON SONO FORNIBILI SEPARATAMENTE TRANNE QUELLI CODIFICATI.

SPARE PARTS KITS

EACH KIT SHOWN WITH THE SAME COLOR INCLUDES ALSO THE GASKETS. THE SPARE PARTS INCLUDED IN THE KIT CAN'T BE SUPPLIED SEPARATELY EXCEPT THOSE SHOWN WITH A PROPER CODE.

CODICE CODE	DESCRIZIONE DESCRIPTION	Q.TÀ QTY
KR8105	SET VITI ARROTOLATORE SET OF SCREWS FOR HOSEREEL	1
KR8306	DENTE D'ARRESTO DETENT	1
KR8308	KIT CREMAGLIERA RACK KIT	1
KR8815	KIT PORTA RULLI ARROTOLATORE ROLLERS HOLDING KIT FOR HOSEREEL	1
KR8816	STAFFA PER ARROTOLATORE WALL MOUNTED BRACKET FOR HOSEREEL	1
KR8907	TAMPONE FERMATUBO HOSE STOP	1

ELENCO RICAMBI FORNIBILI SINGOLARMENTE

LIST OF SPARE PARTS WHICH CAN BE SUPPLIED SEPARATELY

CODICE CODE	DESCRIZIONE DESCRIPTION	Q.TÀ QTY
B121	NIPPLES SINISTRO LEFT ADAPTOR	1
B122	NIPPLES DESTRO RIGHT ADAPTOR	1
F592/R7035	BRACCIO ORIENTABILE SWINGING ARM	1
F594/R7035	BRACCIO ORIENTABILE SWINGING ARM	1
F833/R7035	STAFFA ORIENTABILE SWIVELLING BRACKET	1
I142	INSERTO USCITA TUBO HOSE OUTLET PROTECTION	1
KC409/R7035	TAMBURO 510 510 HOSEREEL DRUM	1
KG168	CARTER-MOLLA COVER SPRING-GROUP	1
KG209	SNODO SINISTRO 20 BAR LEFT JOINT 20 BAR	1
KG210	SNODO DESTRO 20 BAR RIGHT JOINT 20 BAR	1
P051	BOCCOLA LATO CREMAGLIERA BUSH	1
P054	BOCCOLA LATO MOLLA BUSH	1

ELENCO GUARNIZIONI SNODI

JOINTS GASKETS LIST

CODICE CODE	DESCRIZIONE DESCRIPTION	Q.TÀ QTY
H206	GUARNIZIONE OR 3043 VITON GASKET	4



Art. 8520.800 Mod. 520 GAS



VISTA ESPLOSA - EXPLODED VIEW

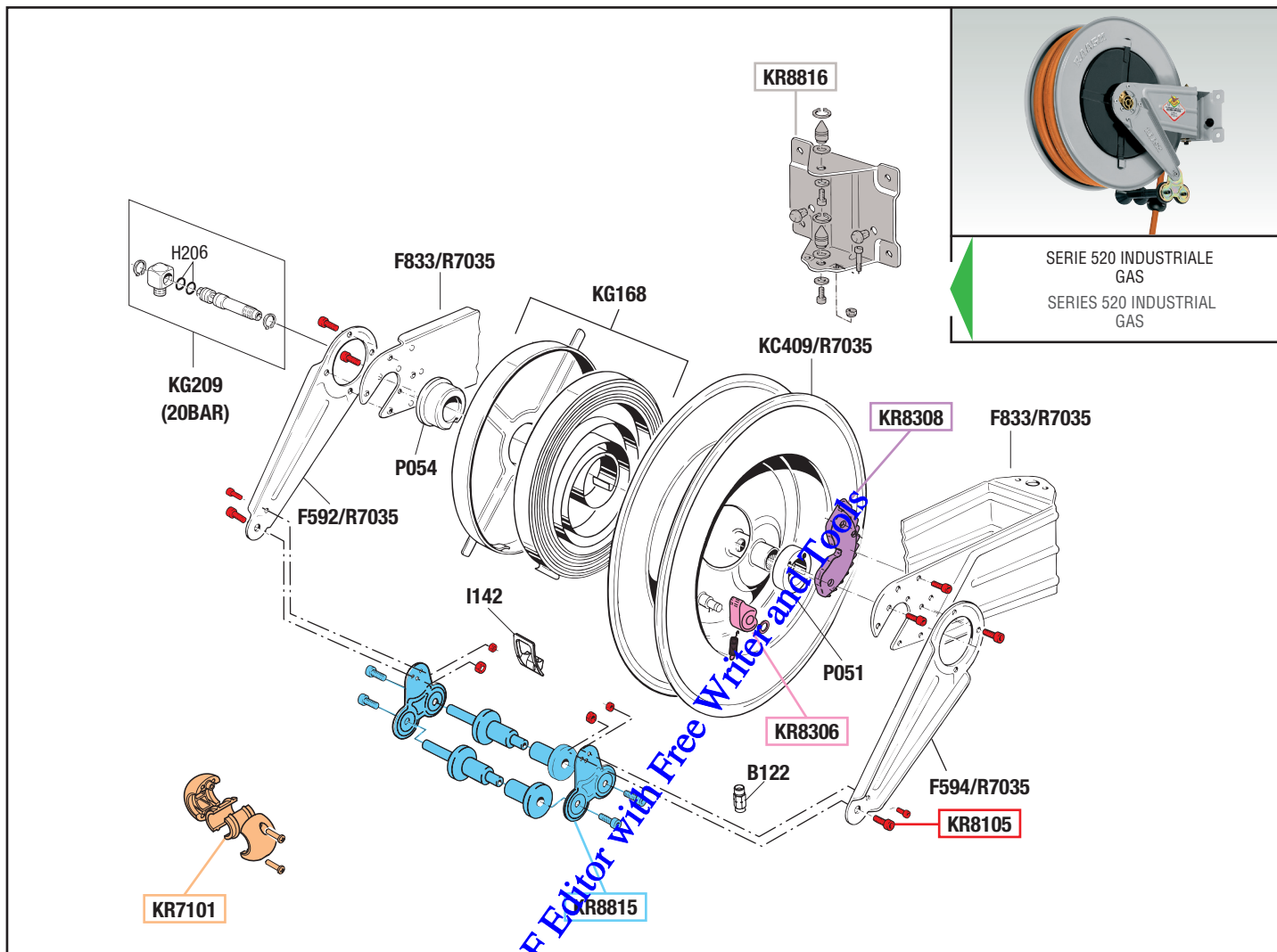

tutti i diritti riservati - all rights reserved

GUIDA RICAMBI - SPARE PARTS GUIDE

KIT RICAMBI

OGNI KIT SOTTO RIPORTATO COMPRENDE I RICAMBI EVIDENZIATI CON LO STESSO COLORE E LE RELATIVE GUARNIZIONI. QUESTI RICAMBI NON SONO FORNIBILI SEPARATAMENTE TRANNE QUELLI CODIFICATI.

SPARE PARTS KITS

EACH KIT SHOWN WITH THE SAME COLOR INCLUDES ALSO THE GASKETS. THE SPARE PARTS INCLUDED IN THE KIT CAN'T BE SUPPLIED SEPARATELY EXCEPT THOSE SHOWN WITH A PROPER CODE.

CODICE CODE	DESCRIZIONE DESCRIPTION	Q.TÀ QTY
KR7101	TAMPONE FERMATUBO HOSE STOP	1
KR8105	SET VITI ARROTATORE SET OF SCREWS FOR HOSE REEL	1
KR8306	DENTE D'ARRESTO DETENT	1
KR8308	KIT CREMAGLIERA RACK KIT	1
KR8815	KIT PORTA RULLI ARROTATORE ROLLERS HOLDING KIT FOR HOSE REEL	1
KR8816	STAFFA PER ARROTATORE WALL MOUNTED BRACKET FOR HOSE REEL	1

ELENCO RICAMBI FORNIBILI SINGOLARMENTE

LIST OF SPARE PARTS WHICH CAN BE SUPPLIED SEPARATELY

CODICE CODE	DESCRIZIONE DESCRIPTION	Q.TÀ QTY
B122	NIPPES SINISTRO LEFT ADAPTOR	1
F592/R7035	BRACCIO ORIENTABILE SWINGING ARM	1
F594/R7035	BRACCIO ORIENTABILE SWINGING ARM	1
F833/R7035	STAFFA ORIENTABILE SWIVELLING BRACKET	1
I142	INSERTO FORO USCITA TUBO HOSE OUTLET PROTECTION	1
KC409/R7035	TAMBURO 510 510 HOSE REEL DRUM	1
KG168	CARTER-MOLLA COVER-SPRING GROUP	1
KG209	SNODO SX 20 BAR HOSE REEL JOINT	1
P051	BOCCOLA LATO CREMAGLIERA BUSH	1
P054	BOCCOLA LATO MOLLA BUSH	1

ELENCO GUARNIZIONI SNODI

JOINTS GASKETS LIST

CODICE CODE	DESCRIZIONE DESCRIPTION	Q.TÀ QTY
H206	GUARNIZIONE OR 3043 VITON GASKET	2



Art. 8522.100 Mod. 522-20 bar - Art. 8522.500 Mod. 522-600 bar
 Art. 8524.200 Mod. 524-100 bar - Art. 8524.300 Mod. 524-200 bar
 Art. 8524.350 Mod. 524-400 bar



VISTA ESPLOSA - EXPLODED VIEW

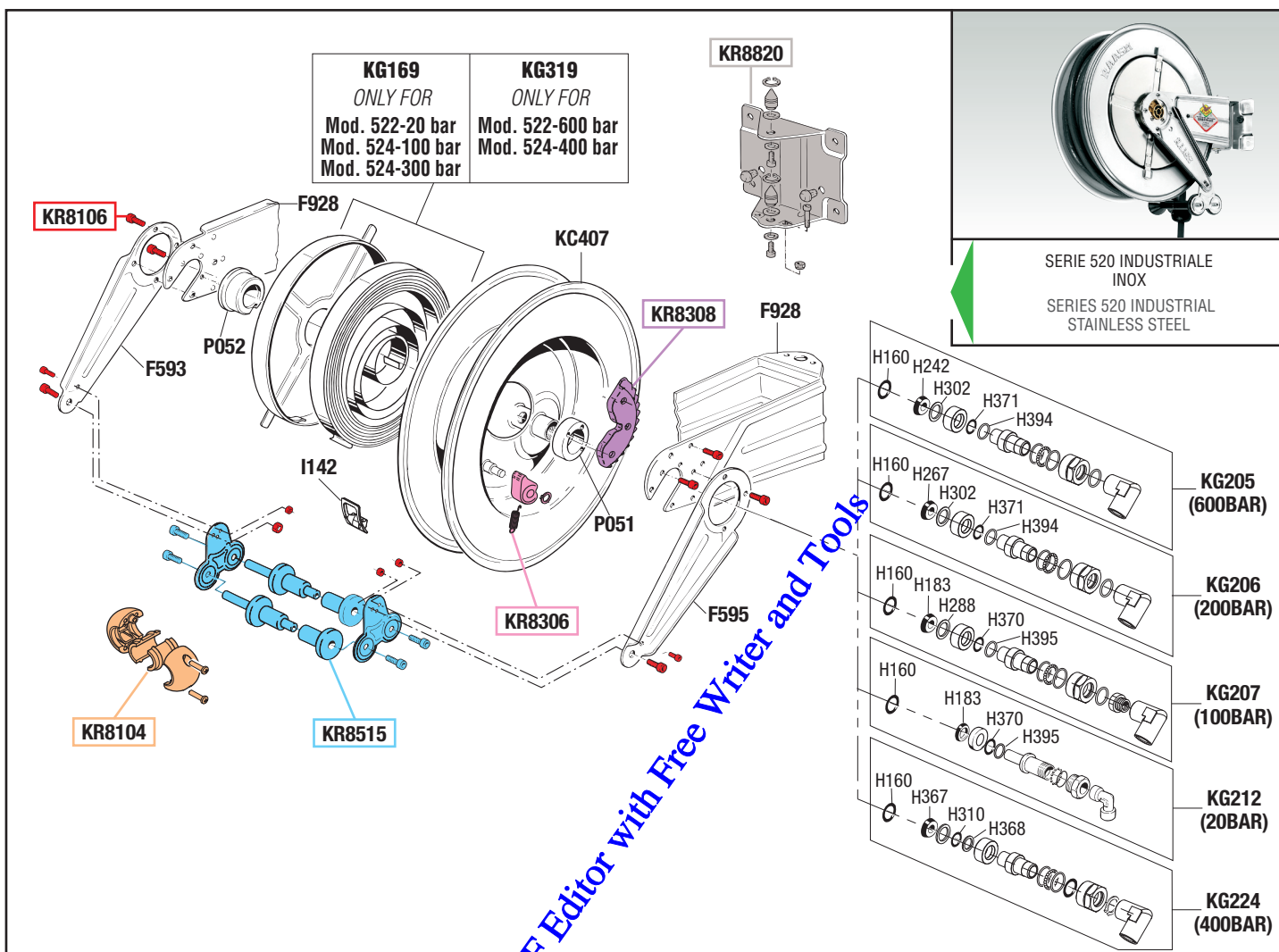

SERIE 520 INDUSTRIALE INOX
 SERIES 520 INDUSTRIAL STAINLESS STEEL

GUIDA RICAMBI - SPARE PARTS GUIDE

KIT RICAMBI
 OGNI KIT SOTTO RIPORTATO COMPRENDE I RICAMBI EVIDENZIATI CON LO STESSO COLORE E LE RELATIVE GUARNIZIONI. QUESTI RICAMBI NON SONO FORNIBILI SEPARATAMENTE TRANNE QUELLI CODIFICATI.

SPARE PARTS KITS
 EACH KIT SHOWN WITH THE SAME COLOR INCLUDES ALSO THE GASKETS. THE SPARE PARTS INCLUDED IN THE KIT CAN'T BE SUPPLIED SEPARATELY EXCEPT THOSE SHOWN WITH A PROPER CODE.

CODICE CODE	DESCRIZIONE DESCRIPTION	Q.TÀ QTY
KR8104	TAMPONE FERMATUBO HOSE STOP	1
KR8106	SET VITI ARROTOLATORE SET OF SCREWS FOR HOSEREEL	1
KR8306	DENTE D'ARRESTO DETENT	1
KR8308	KIT CREMAGLIERA RACK KIT	1
KR8515	KIT PORTA RULLI ARROTOLATORE ROLLERS HOLDING KIT FOR HOSEREEL	1
KR8820	STAFFA PER ARROTOLATORE WALL MOUNTED BRACKET FOR HOSEREEL	1

ELENCO RICAMBI FORNIBILI SINGOLARMENTE
 LIST OF SPARE PARTS WHICH CAN BE SUPPLIED SEPARATELY

CODICE CODE	DESCRIZIONE DESCRIPTION	Q.TÀ QTY
F593	BRACCIO ORIENTABILE SWINGING ARM	1
F595	BRACCIO ORIENTABILE SWINGING ARM	1
F928	STAFFA ORIENTABILE SWIVELLING BRACKET	1
I142	INSERTO USCITA TUBO HOSE OUTLET PROTECTION	1
KC407	TAMBURO 510 510 HOSEREEL DRUM	1
KG169	CARTER-MOLLA COVER SPRING-GROUP	1
KG205	SNODO GRASSO 600 BAR JOINT GREASE 600 BAR	1
KG206	SNODO ACQUA 200 BAR JOINT WATER 200 BAR	1
KG207	SNODO ACQUA 100 BAR JOINT WATER 100 BAR	1
KG212	SNODO ARIA-ACQUA 20 BAR JOINT AIR-WATER 20 BAR	1
KG224	SNODO ACQUA 400 BAR JOINT WATER 400 BAR	1
KG319	CARTER-MOLLA (Art.8524.350-8522.500) COVER SPRING-GROUP (Art.8524.350-8522.500)	1
P051	BOCCOLA LATO CREMAGLIERA BUSH	1
P052	BOCCOLA LATO MOLLA BUSH	1

ELENCO GUARNIZIONI SNODI
 JOINTS GASKETS LIST

CODICE CODE	DESCRIZIONE DESCRIPTION	Q.TÀ QTY
H160	O-RING 2093 O-RING 2093	1
H183	GUARNIZIONE GASKET	1
H242	GUARNIZIONE M4 1810-PUR95 GASKET	1
H267	GUARNIZIONE VITON 90SH GASKET	1
H288	RONDELLA IN PTFE PTFE WASHER	1
H302	RONDELLA IN PTFE PTFE WASHER	1
H310	O-RING 112 VITON O-RING 112 VITON	1
H367	GUARNIZIONE GASKET	1
H368	RONDELLA IN PTFE PTFE WASHER	1
H370	O-RING 2062 VITON O-RING 2062 VITON	1
H371	GUARNIZIONE OR 2037 VITON GASKET	1
H394	RONDELLA IN PTFE PTFE WASHER	1
H395	RONDELLA IN PTFE PTFE WASHER	1

tutti i diritti riservati - all rights reserved



Art. 8530.100 Mod. 530-20 bar - Art. 8530.200 Mod. 530-100 bar
 Art. 8530.300 Mod. 530-200 bar - Art. 8530.350 Mod. 530-400 bar
 Art. 8530.400 Mod. 530-150 bar - Art. 8530.500 Mod. 530-600 bar



VISTA ESPLOSA - EXPLODED VIEW

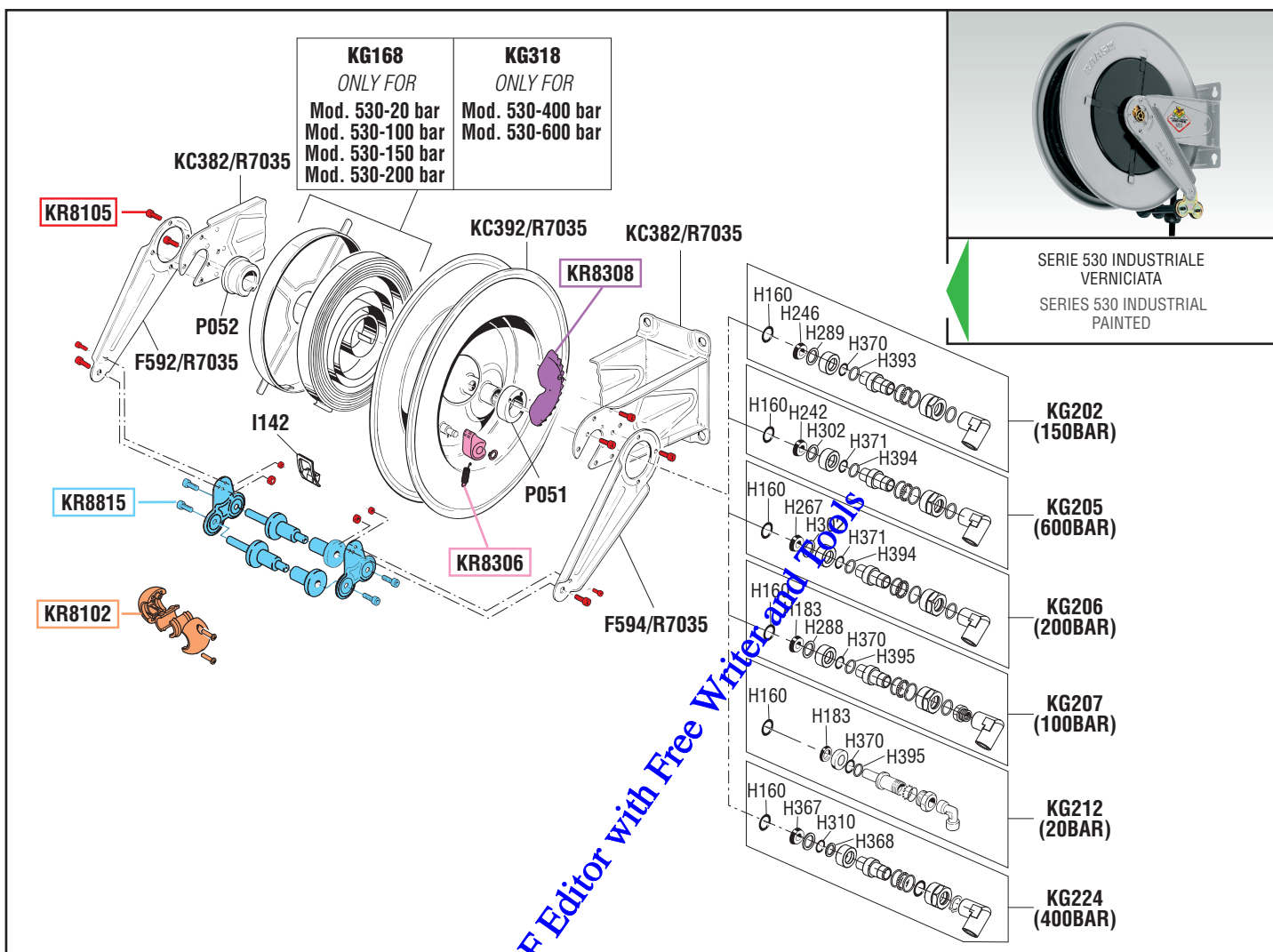

SERIE 530 INDUSTRIALE
 VERNICIATA
 SERIES 530 INDUSTRIAL
 PAINTED

GUIDA RICAMBI - SPARE PARTS GUIDE

KIT RICAMBI
 OGNI KIT SOTTO RIPORTATO COMPRENDE I RICAMBI EVIDENZIATI CON LO STESSO COLORE E LE RELATIVE GUARNIZIONI. QUESTI RICAMBI NON SONO FORNIBILI SEPARATAMENTE TRANNE QUELLI CODIFICATI.

SPARE PARTS KITS
 EACH KIT SHOWN WITH THE SAME COLOR INCLUDES ALSO THE GASKETS. THE SPARE PARTS INCLUDED IN THE KIT CAN'T BE SUPPLIED SEPARATELY EXCEPT THOSE SHOWN WITH A PROPER CODE.

CODICE CODE	DESCRIZIONE DESCRIPTION	Q.TÀ QTY
KR8102	TAMPONE FERMATUBO HOSE STOP	1
KR8105	SET VITI ARROTOLATORE SET OF SCREWS FOR HOSEREEL	1
KR8306	DENTE D'ARRESTO DETENT	1
KR8308	KIT CREMAGLIERA RACK KIT	1
KR8815	KIT PORTA RULLI ARROTOLATORE ROLLERS HOLDING KIT FOR HOSEREEL	1

ELENCO RICAMBI FORNIBILI SINGOLARMENTE
 LIST OF SPARE PARTS WHICH CAN BE SUPPLIED SEPARATELY

CODICE CODE	DESCRIZIONE DESCRIPTION	Q.TÀ QTY
F592/R7035	BRACCIO ORIENTABILE SWINGING ARM	1
F594/R7035	BRACCIO ORIENTABILE SWINGING ARM	1
I142	INSERTO FORO USCITA TUBO HOSE OUTLET PROTECTION	1
KC382/R7035	SUPPORTO ARROTOLATORE HOSEREEL SUPPORT	1
KC392/R7035	TAMBURO 510 510 HOSEREEL DRUM	1
KG168	CARTER-MOLLA COVER-SPRING GROUP	1
KG202	SNODO OLIO 150 BAR JOINT OIL 150 BAR	1
KG205	SNODO GRASSO 600 BAR JOINT GREASE 600 BAR	1
KG206	SNODO ACQUA 200 BAR JOINT WATER 200 BAR	1
KG207	SNODO ACQUA 100 BAR JOINT WATER 100 BAR	1
KG212	SNODO ARIA-ACQUA 20 BAR JOINT AIR-WATER 20 BAR	1
KG224	SNODO ACQUA 400 BAR JOINT WATER 400 BAR	1
KG318	CARTER-MOLLA (Art.8530.500-8530.500) COVER-SPRING GROUP (Art.8530.500-8530.500)	1
P051	BOCCOLA LATO CREMAGLIERA BUSH	1
P052	BOCCOLA LATO MOLLA BUSH	1

ELENCO GUARNIZIONI SNODI
 JOINTS GASKETS LIST

CODICE CODE	DESCRIZIONE DESCRIPTION	Q.TÀ QTY
H160	O-RING 2093 O-RING 2093	1
H183	GUARNIZIONE GASKET	1
H242	GUARNIZIONE M4 1810-PUR95 GASKET	1
H246	GUARNIZIONE MAD 2060/2-PUR95 GASKET	1
H267	GUARNIZIONE VITON 90SH GASKET	1
H288	RONDELLA IN PTFE PTFE WASHER	1
H289	RONDELLA IN PTFE PTFE WASHER	1
H302	RONDELLA IN PTFE PTFE WASHER	1
H310	O-RING 112 VITON O-RING 112 VITON	1
H367	GUARNIZIONE GASKET	1
H368	RONDELLA IN PTFE PTFE WASHER	1
H370	O-RING 2062 VITON O-RING 2062 VITON	1
H371	O-RING 2037 VITON O-RING 2037 VITON	1
H393	RONDELLA IN PTFE PTFE WASHER	1
H394	RONDELLA IN PTFE PTFE WASHER	1
H395	RONDELLA IN PTFE PTFE WASHER	1

tutti i diritti riservati - all rights reserved



Art. 8530.600 Mod. 530-1"-20 bar



VISTA ESPLOSA - EXPLODED VIEW

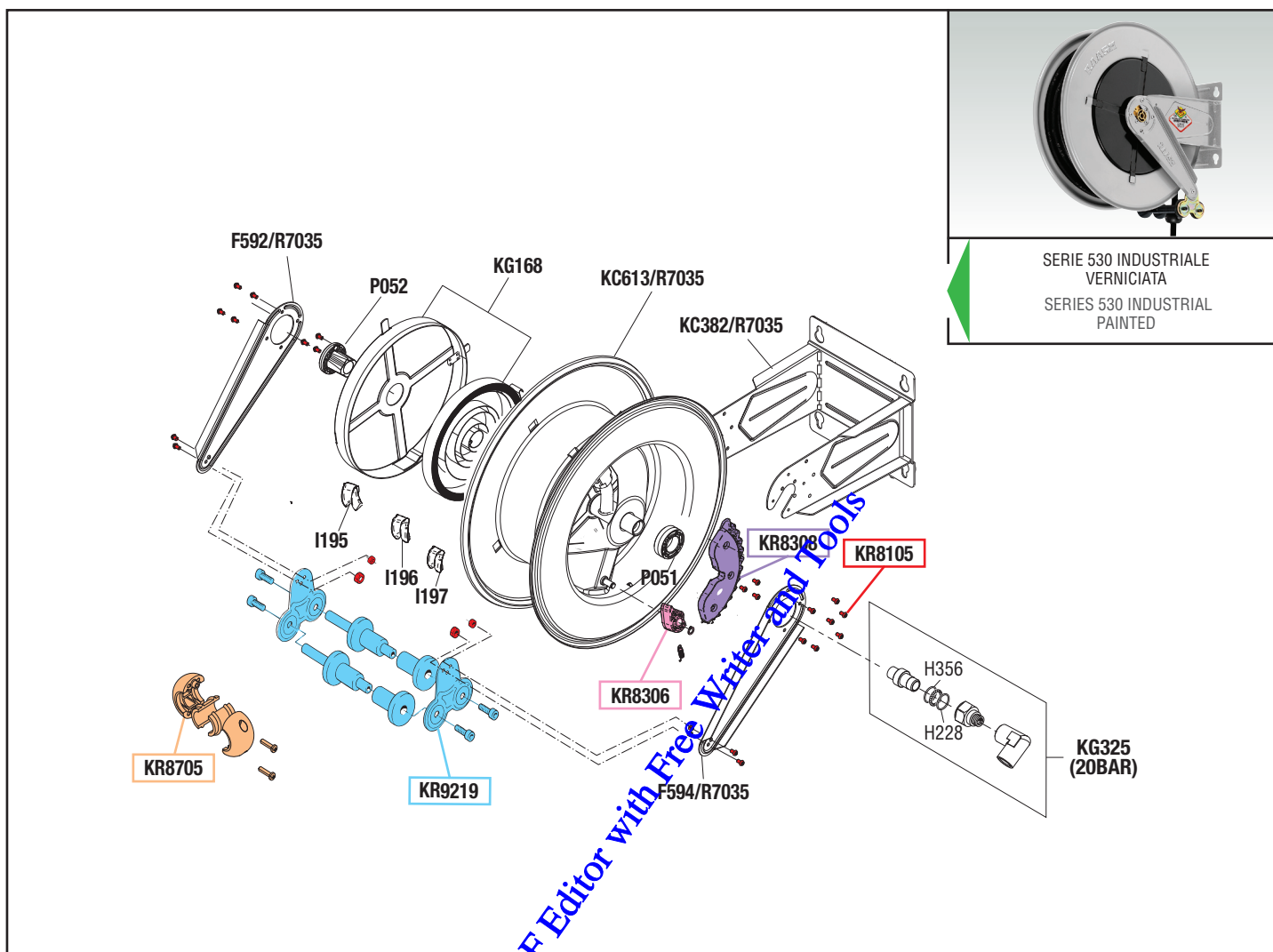

SERIE 530 INDUSTRIALE
VERNICIATA
SERIES 530 INDUSTRIAL
PAINTED

GUIDA RICAMBI - SPARE PARTS GUIDE

KIT RICAMBI

OGNI KIT SOTTO RIPORTATO COMPRENDE I RICAMBI EVIDENZIATI CON LO STESSO COLORE E LE RELATIVE GUARNIZIONI. QUESTI RICAMBI NON SONO FORNIBILI SEPARATAMENTE TRANNE QUELLI CODIFICATI.

SPARE PARTS KITS

EACH KIT SHOWN WITH THE SAME COLOR INCLUDES ALSO THE GASKETS. THE SPARE PARTS INCLUDED IN THE KIT CAN'T BE SUPPLIED SEPARATELY EXCEPT THOSE SHOWN WITH A PROPER CODE.

CODICE CODE	DESCRIZIONE DESCRIPTION	Q.TÀ QTY
KR8105	SET VITI ARROTOLATORE SET OF SCREWS FOR HOSEREEL	1
KR8306	DENTE D'ARRESTO DETENT	1
KR8308	KIT CREMAGLIERA RACK KIT	1
KR8705	TAMPONE FERMATUBO HOSE STOP	1
KR9219	KIT PORTA RULLI ARROTOLATORE ROLLERS HOLDING KIT FOR HOSEREEL	1

ELENCO RICAMBI FORNIBILI SINGOLARMENTE

LIST OF SPARE PARTS WHICH CAN BE SUPPLIED SEPARATELY

CODICE CODE	DESCRIZIONE DESCRIPTION	Q.TÀ QTY
F592/R7035	BRACCIO ORIENTABILE SWINGING ARM	1
F594/R7035	BRACCIO ORIENTABILE SWINGING ARM	1
I195	INSERTO FORO USCITA TUBO Ø 34-38 HOSE OUTLET PROTECTION Ø 34-38	1
I196	INSERTO FORO USCITA TUBO Ø 30-34 HOSE OUTLET PROTECTION Ø 30-34	1
I197	INSERTO FORO USCITA TUBO Ø 26-30 HOSE OUTLET PROTECTION Ø 26-30	1
KC382/R7035	SUPPORTO ARROTOLATORE HOSEREEL SUPPORT	1
KC613/R7035	TAMBURO 510 510 HOSEREEL DRUM	1
KG168	CARTER-MOLLA COVER-SPRING GROUP	1
KG325	SNODO ARIA-ACQUA 20 BAR JOINT AIR-WATER 20 BAR	1
P051	BOCCOLA ARROTOLATORE BUSH	1
P052	BOCCOLA LATO MOLLA BUSH	1

ELENCO GUARNIZIONI SNODI

JOINTS GASKETS LIST

CODICE CODE	DESCRIZIONE DESCRIPTION	Q.TÀ QTY
H228	O-RING 3106 "VITON" O-RING 3106 "VITON"	1
H356	O-RING 4112 "VITON" O-RING 4112 "VITON"	1

tutti i diritti riservati - all rights reserved



Art. 8530.700 Mod. 530 BIN



VISTA ESPLOSA - EXPLODED VIEW

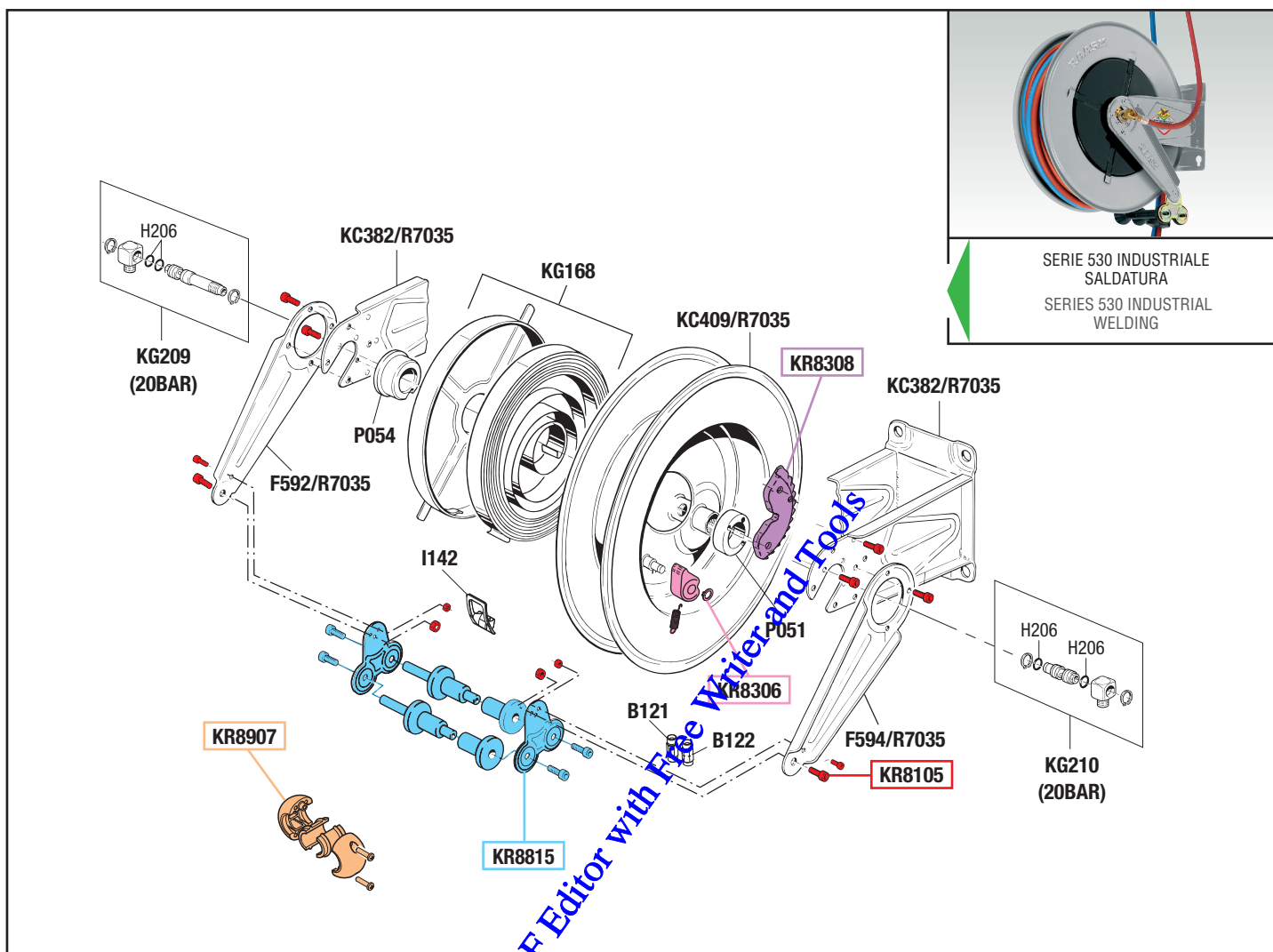

tutti i diritti riservati - all rights reserved

GUIDA RICAMBI - SPARE PARTS GUIDE

KIT RICAMBI

OGNI KIT SOTTO RIPORTATO COMPRENDE I RICAMBI EVIDENZIATI CON LO STESSO COLORE E LE RELATIVE GUARNIZIONI. QUESTI RICAMBI NON SONO FORNIBILI SEPARATAMENTE TRANNE QUELLI CODIFICATI.

SPARE PARTS KITS

EACH KIT SHOWN WITH THE SAME COLOR INCLUDES ALSO THE GASKETS. THE SPARE PARTS INCLUDED IN THE KIT CAN'T BE SUPPLIED SEPARATELY EXCEPT THOSE SHOWN WITH A PROPER CODE.

CODICE CODE	DESCRIZIONE DESCRIPTION	Q.TÀ QTY
KR8105	SET VITI ARROTOLATORE SET OF SCREWS FOR HOSEREEL	1
KR8306	DENTE D'ARRESTO DETENT	1
KR8308	KIT CREMAGLIERA RACK KIT	1
KR8815	KIT PORTA RULLI ARROTOLATORE ROLLERS HOLDING KIT FOR HOSEREEL	1
KR8907	TAMPONE FERMATUBO HOSE STOP	1

ELENCO RICAMBI FORNIBILI SINGOLARMENTE

LIST OF SPARE PARTS WHICH CAN BE SUPPLIED SEPARATELY

CODICE CODE	DESCRIZIONE DESCRIPTION	Q.TÀ QTY
B121	NIPPES SINISTRO LEFT ADAPTOR	1
B122	NIPPES DESTRO RIGHT ADAPTOR	1
F592/R7035	BRACCIO ORIENTABILE SWINGING ARM	1
F594/R7035	BRACCIO ORIENTABILE SWINGING ARM	1
I142	INSERTO USCITA TUBO HOSE OUTLET PROTECTION	1
KC382/R7035	SUPPORTO ARROTOLATORE HOSEREEL SUPPORT	1
KC409/R7035	TAMBURO 510 510 HOSEREEL DRUM	1
KG168	CARTER-MOLLA COVER SPRING-GROUP	1
KG209	SNODO SINISTRO 20 BAR LEFT JOINT 20 BAR	1
KG210	SNODO DESTRO 20 BAR RIGHT JOINT 20 BAR	1
P051	BOCCOLA LATO CREMAGLIERA BUSH	1
P054	BOCCOLA LATO MOLLA BUSH	1

ELENCO GUARNIZIONI SNODI

JOINTS GASKETS LIST

CODICE CODE	DESCRIZIONE DESCRIPTION	Q.TÀ QTY
H206	O-RING 3043 VITON O-RING 3043 VITON	4



Art. 8530.800 Mod. 530 GAS



VISTA ESPLOSA - EXPLODED VIEW

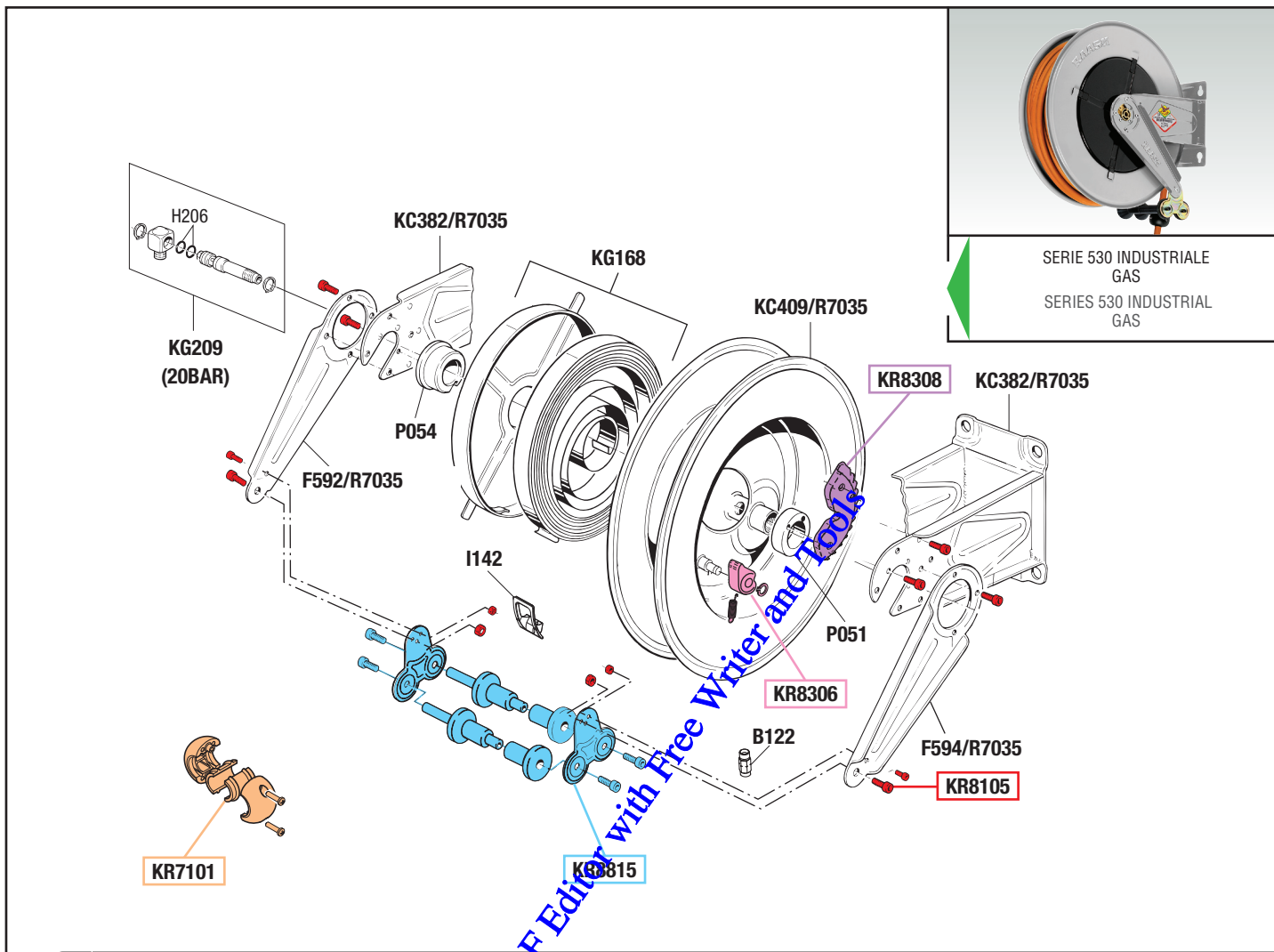

tutti i diritti riservati - all rights reserved

GUIDA RICAMBI - SPARE PARTS GUIDE

KIT RICAMBI
OGNI KIT SOTTO RIPORTATO COMPRENDE I RICAMBI EVIDENZIATI CON LO STESSO COLORE E LE RELATIVE GUARNIZIONI. QUESTI RICAMBI NON SONO FORNIBILI SEPARATAMENTE TRANNE QUELLI CODIFICATI.

SPARE PARTS KITS
EACH KIT SHOWN WITH THE SAME COLOR INCLUDES ALSO THE GASKETS. THE SPARE PARTS INCLUDED IN THE KIT CAN'T BE SUPPLIED SEPARATELY EXCEPT THOSE SHOWN WITH A PROPER CODE.

CODICE CODE	DESCRIZIONE DESCRIPTION	Q.TÀ QTY
KR7101	TAMPONE FERMATUBO HOSE STOP	1
KR8105	SET VITI ARROTOLATORE SET OF SCREWS FOR HOSEREEL	1
KR8306	DENTE D'ARRESTO DETENT	1
KR8308	KIT CREMAGLIERA RACK KIT	1
KR8815	KIT PORTA RULLI ARROTOLATORE ROLLERS HOLDING KIT FOR HOSEREEL	1

ELENCO RICAMBI FORNIBILI SINGOLARMENTE
LIST OF SPARE PARTS WHICH CAN BE SUPPLIED SEPARATELY

CODICE CODE	DESCRIZIONE DESCRIPTION	Q.TÀ QTY
B122	NIPPES SINISTRO LEFT ADAPTOR	1
F592/R7035	BRACCIO ORIENTABILE SWINGING ARM	1
F594/R7035	BRACCIO ORIENTABILE SWINGING ARM	1
I142	INSERTO FORO USCITA TUBO HOSE OUTLET PROTECTION	1
KC382/R7035	SUPPORTO ARROTOLATORE HOSEREEL SUPPORT	1
KC409/R7035	TAMBURO 510 510 HOSEREEL DRUM	1
KG168	CARTER-MOLLA COVER-SPRING GROUP	1
KG209	SNODO SX 20 BAR HOSEREEL JOINT	1
P051	BOCCOLA LATO CREMAGLIERA BUSH	1
P054	BOCCOLA LATO MOLLA BUSH	1

ELENCO GUARNIZIONI SNODI
JOINTS GASKETS LIST

CODICE CODE	DESCRIZIONE DESCRIPTION	Q.TÀ QTY
H206	O-RING 3043 VITON O-RING 3043 VITON	2



Art. 8530.1000 Mod. 530-2x20 bar - Art. 8530.4000 Mod. 530-2x200 bar



VISTA ESPLOSA - EXPLODED VIEW

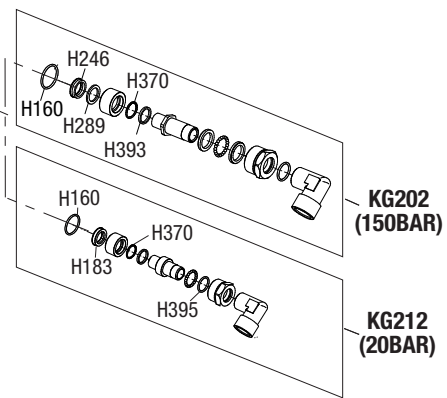
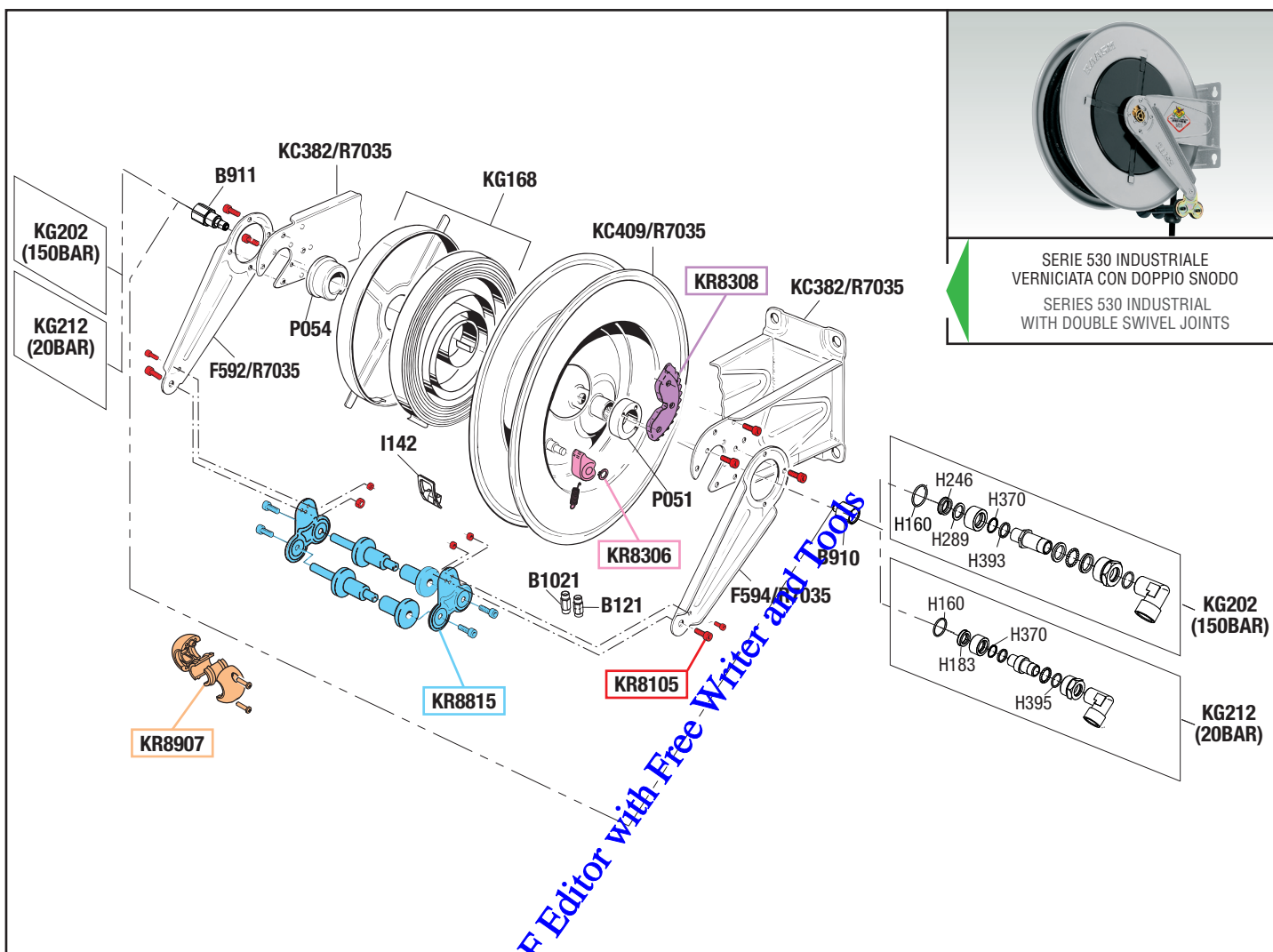

GUIDA RICAMBI - SPARE PARTS GUIDE

KIT RICAMBI
OGNI KIT SOTTO RIPORTATO COMPRENDE I RICAMBI EVIDENZIATI CON LO STESSO COLORE E LE RELATIVE GUARNIZIONI. QUESTI RICAMBI NON SONO FORNIBILI SEPARATAMENTE TRANNE QUELLI CODIFICATI.

SPARE PARTS KITS
EACH KIT SHOWN WITH THE SAME COLOR INCLUDES ALSO THE GASKETS. THE SPARE PARTS INCLUDED IN THE KIT CAN'T BE SUPPLIED SEPARATELY EXCEPT THOSE SHOWN WITH A PROPER CODE.

CODICE CODE	DESCRIZIONE DESCRIPTION	Q.TÀ QTY
KR8105	SET VITI ARROTOLATORE SET OF SCREWS FOR HOSEREEL	1
KR8306	DENTE D'ARRESTO DETENT	1
KR8308	KIT CREMAGLIERA RACK KIT	1
KR8815	KIT PORTA RULLI ARROTOLATORE ROLLERS HOLDING KIT FOR HOSEREEL	1
KR8907	TAMPONE FERMATUBO HOSE STOP	1

ELENCO RICAMBI FORNIBILI SINGOLARMENTE
LIST OF SPARE PARTS WHICH CAN BE SUPPLIED SEPARATELY

CODICE CODE	DESCRIZIONE DESCRIPTION	Q.TÀ QTY
B121	NIPPLO DESTRO RIGHT ADAPTOR	1
B910	ADATTATORE SNODO LATO CREMAGLIERA SWIVEL JOINT ADAPTOR	1
B911	ADATTATORE SNODO LATO MOLLA SWIVEL JOINT ADAPTOR	1
B1021	NIPPLO SINISTRO LEFT ADAPTOR	1
F592/R7035	BRACCIO ORIENTABILE SWINGING ARM	1
F594/R7035	BRACCIO ORIENTABILE SWINGING ARM	1
I142	INSERTO FORO USCITA TUBO HOSE OUTLET PROTECTION	1
KC382/R7035	SUPPORTO ARROTOLATORE HOSEREEL SUPPORT	1
KC409/R7035	TAMBURO 530 530 HOSEREEL DRUM	1
KG168	CARTER-MOLLA COVER-SPRING GROUP	1
KG202	SNODO OLIO 150 BAR JOINT OIL 150 BAR	2
KG212	SNODO ARIA-ACQUA 20 BAR JOINT AIR-WATER 20 BAR	2
P051	BOCCOLA LATO CREMAGLIERA BUSH	1
P054	BOCCOLA LATO MOLLA BUSH	1

ELENCO GUARNIZIONI SNODI
JOINTS GASKETS LIST

CODICE CODE	DESCRIZIONE DESCRIPTION	Q.TÀ QTY
H160	O-RING 2093 O-RING 2093	1
H183	GUARNIZIONE GASKET	1
H246	GUARNIZ. MAD2060/2-PUR95 GASKET	1
H289	RONDELLA IN PTFE PTFE WASHER	1
H370	GUARNIZIONE OR 2062 VITON GASKET	1
H393	RONDELLA IN PTFE PTFE WASHER	1
H395	RONDELLA IN PTFE PTFE WASHER	1

tutti i diritti riservati - all rights reserved



Art. 8530.3000 Mod. 530-2x200 bar - Art. 8530.5000 Mod. 530-2x400 bar



VISTA ESPLOSA - EXPLODED VIEW

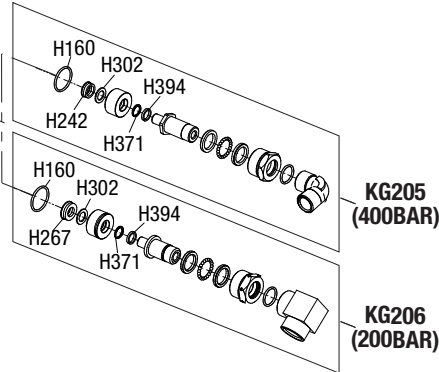
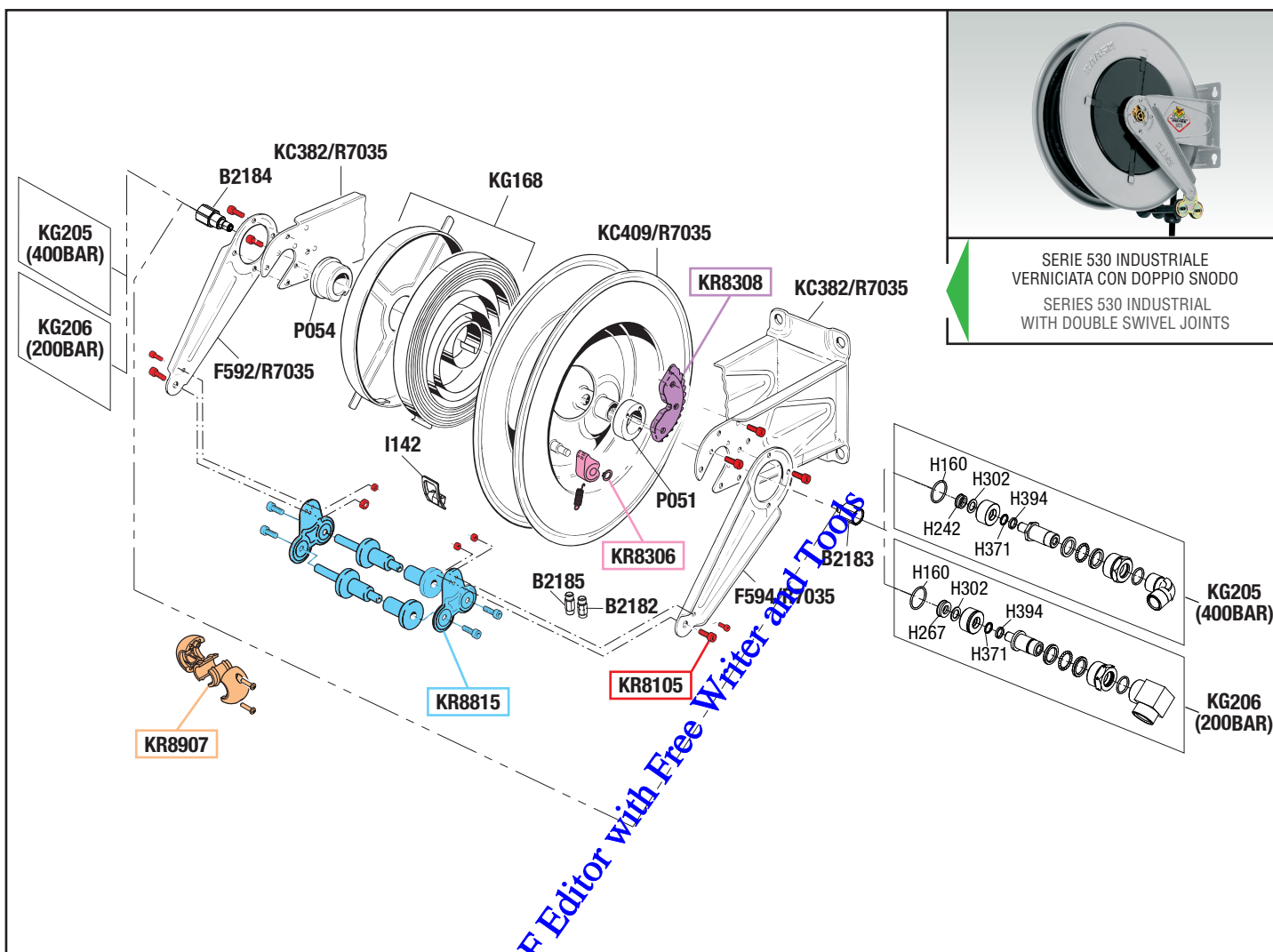

GUIDA RICAMBI - SPARE PARTS GUIDE

KIT RICAMBI
OGNI KIT SOTTO RIPORTATO COMPRENDE I RICAMBI EVIDENZIATI CON LO STESSO COLORE E LE RELATIVE GUARNIZIONI. QUESTI RICAMBI NON SONO FORNIBILI SEPARATAMENTE TRANNE QUELLI CODIFICATI.

SPARE PARTS KITS
EACH KIT SHOWN WITH THE SAME COLOR INCLUDES ALSO THE GASKETS. THE SPARE PARTS INCLUDED IN THE KIT CAN'T BE SUPPLIED SEPARATELY EXCEPT THOSE SHOWN WITH A PROPER CODE.

CODICE CODE	DESCRIZIONE DESCRIPTION	Q.TÀ QTY
KR8105	SET VITI ARROTOLATORE SET OF SCREWS FOR HOSEREEL	1
KR8306	DENTE D'ARRESTO DETENT	1
KR8308	KIT CREMAGLIERA RACK KIT	1
KR8815	KIT PORTA RULLI ARROTOLATORE ROLLERS HOLDING KIT FOR HOSEREEL	1
KR8907	TAMPONE FERMATUBO HOSE STOP	1

ELENCO RICAMBI FORNIBILI SINGOLARMENTE
LIST OF SPARE PARTS WHICH CAN BE SUPPLIED SEPARATELY

CODICE CODE	DESCRIZIONE DESCRIPTION	Q.TÀ QTY
B2182	NIPPLE DESTRO RIGHT ADAPTOR	1
B2183	ADATTATORE SNODO LATO CREMAGLIERA SWIVEL JOINT ADAPTOR	1
B2184	ADATTATORE SNODO LATO MOLLA SWIVEL JOINT ADAPTOR	1
B2185	NIPPLE SINISTRO LEFT ADAPTOR	1
F592/R7035	BRACCIO ORIENTABILE SWINGING ARM	1
F594/R7035	BRACCIO ORIENTABILE SWINGING ARM	1
I142	INSERTO FORO USCITA TUBO HOSE OUTLET PROTECTION	1
KC382/R7035	SUPPORTO ARROTOLATORE HOSEREEL SUPPORT	1
KC409/R7035	TAMBURO 530 530 HOSEREEL DRUM	1
KG168	CARTER-MOLLA COVER-SPRING GROUP	1
KG205	SNODO GRASSO 600 BAR JOINT GREASE 600 BAR	2
KG206	SNODO ACQUA 200 BAR JOINT WATER 200 BAR	2
P051	BOCCOLA LATO CREMAGLIERA BUSH	1
P054	BOCCOLA LATO MOLLA BUSH	1

ELENCO GUARNIZIONI SNODI
JOINTS GASKETS LIST

CODICE CODE	DESCRIZIONE DESCRIPTION	Q.TÀ QTY
H160	O-RING 2093 O-RING 2093	1
H242	GUARNIZIONE IM4 1810-PUR95 GASKET	1
H267	GUARNIZIONE VITON 90SH GASKET	1
H302	RONDELLA IN PTFE PTFE WASHER	1
H371	GUARNIZIONE OR 2037 VITON GASKET	1
H394	RONDELLA IN PTFE PTFE WASHER	1

tutti i diritti riservati - all rights reserved



Art. 8532.100 Mod. 532-20 bar - Art. 8532.500 Mod. 532-600 bar
 Art. 8534.200 Mod. 534-100 bar - Art. 8534.300 Mod. 534-200 bar
 Art. 8534.350 Mod. 534-400 bar



VISTA ESPLOSA - EXPLODED VIEW

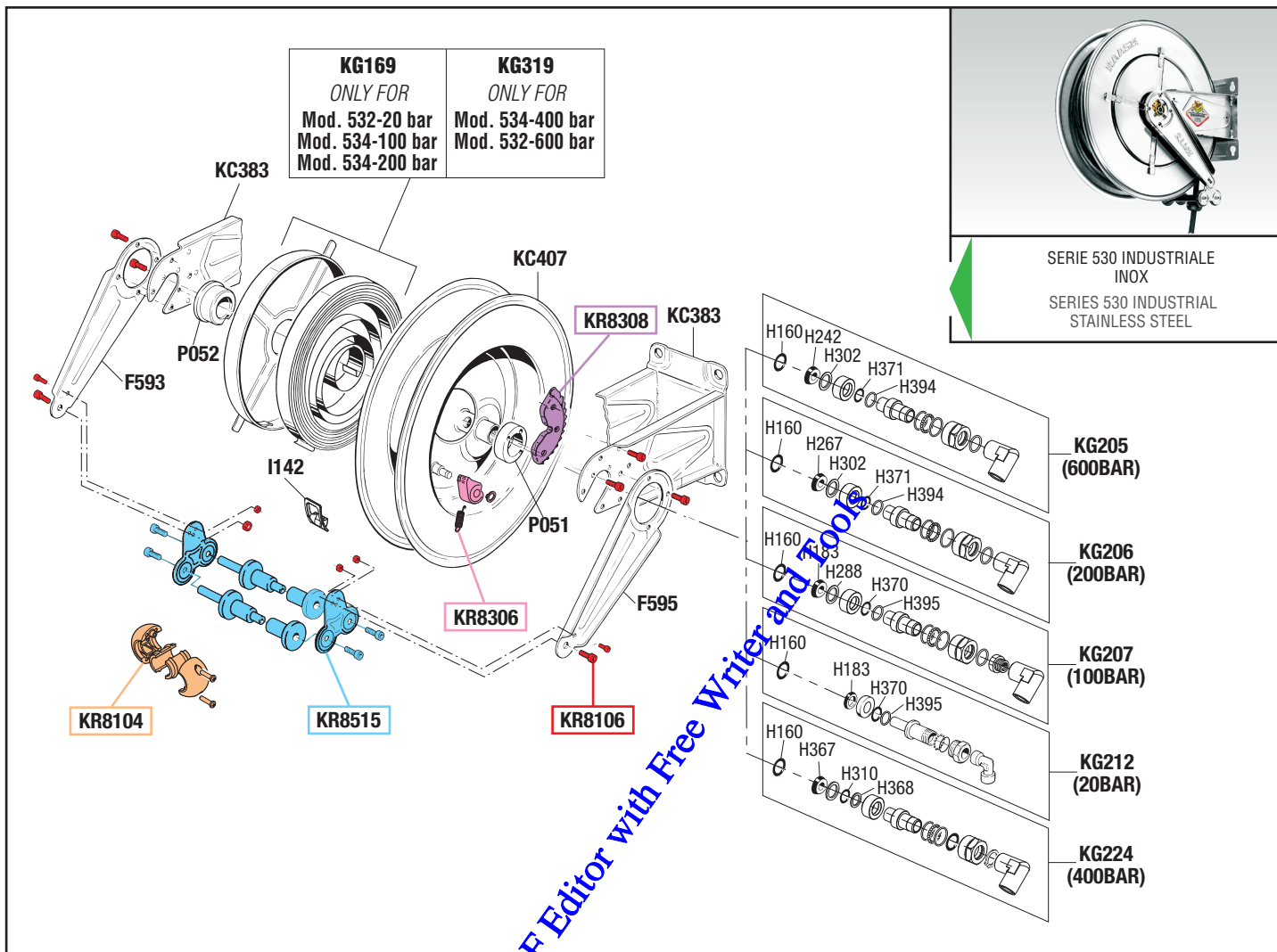

GUIDA RICAMBI - SPARE PARTS GUIDE

KIT RICAMBI
 OGNI KIT SOTTO RIPORTATO COMPRENDE I RICAMBI EVIDENZIATI CON LO STESSO COLORE E LE RELATIVE GUARNIZIONI. QUESTI RICAMBI NON SONO FORNIBILI SEPARATAMENTE TRANNE QUELLI CODIFICATI.

SPARE PARTS KITS
 EACH KIT SHOWN WITH THE SAME COLOR INCLUDES ALSO THE GASKETS. THE SPARE PARTS INCLUDED IN THE KIT CAN'T BE SUPPLIED SEPARATELY EXCEPT THOSE SHOWN WITH A PROPER CODE.

CODICE CODE	DESCRIZIONE DESCRIPTION	Q.TÀ QTY
KR8104	TAMPONE FERMATUBO HOSE STOP	1
KR8106	SET VITI ARROTOLATORE SET OF SCREWS FOR HOSEREEL	1
KR8306	DENTE D'ARRESTO DETENT	1
KR8308	KIT CREMAGLIERA RACK KIT	1
KR8515	KIT PORTA RULLI ARROTOLATORE ROLLERS HOLDING KIT FOR HOSEREEL	1

ELENCO RICAMBI FORNIBILI SINGOLARMENTE
 LIST OF SPARE PARTS WHICH CAN BE SUPPLIED SEPARATELY

CODICE CODE	DESCRIZIONE DESCRIPTION	Q.TÀ QTY
F593	BRACCIO ORIENTABILE SWINGING ARM	1
F595	BRACCIO ORIENTABILE SWINGING ARM	1
I142	INSERTO USCITA TUBO HOSE OUTLET PROTECTION	1
KC383	SUPPORTO ARROTOLATORE HOSEREEL SUPPORT	1
KC407	TAMBURO 510 510 HOSEREEL DRUM	1
KG169	CARTER-MOLLA COVER SPRING-GROUP	1
KG205	SNODO GRASSO 600 BAR JOINT GREASE 600 BAR	1
KG206	SNODO ACQUA 200 BAR JOINT WATER 200 BAR	1
KG207	SNODO ACQUA 100 BAR JOINT WATER 100 BAR	1
KG212	SNODO ARIA-ACQUA 20 BAR JOINT AIR-WATER 20 BAR	1
KG224	SNODO ACQUA 400 BAR JOINT WATER 400 BAR	1
KG319	CARTER-MOLLA (Art.8534.350-8532.500) COVER SPRING-GROUP (Art.8534.350-8532.500)	1
P051	BOCCOLA LATO CREMAGLIERA BUSH	1
P052	BOCCOLA LATO MOLLA BUSH	1

ELENCO GUARNIZIONI SNODI
 JOINTS GASKETS LIST

CODICE CODE	DESCRIZIONE DESCRIPTION	Q.TÀ QTY
H160	O-RING 2093 O-RING 2093	1
H183	GUARNIZIONE GASKET	1
H242	GUARNIZIONE M4 1810-PUR95 GASKET	1
H267	GUARNIZIONE VITON 90SH GASKET	1
H288	RONDELLA IN PTFE PTFE WASHER	1
H302	RONDELLA IN PTFE PTFE WASHER	1
H310	GUARNIZIONE OR 112 VITON GASKET	1
H367	GUARNIZIONE GASKET	1
H368	RONDELLA IN PTFE PTFE WASHER	1
H370	GUARNIZIONE OR 2062 VITON GASKET	1
H371	GUARNIZIONE OR 2037 VITON GASKET	1
H394	RONDELLA IN PTFE PTFE WASHER	1
H395	RONDELLA IN PTFE PTFE WASHER	1

tutti i diritti riservati - all rights reserved



Art. 8532.700 Mod. 532 BIN



VISTA ESPLOSA - EXPLODED VIEW

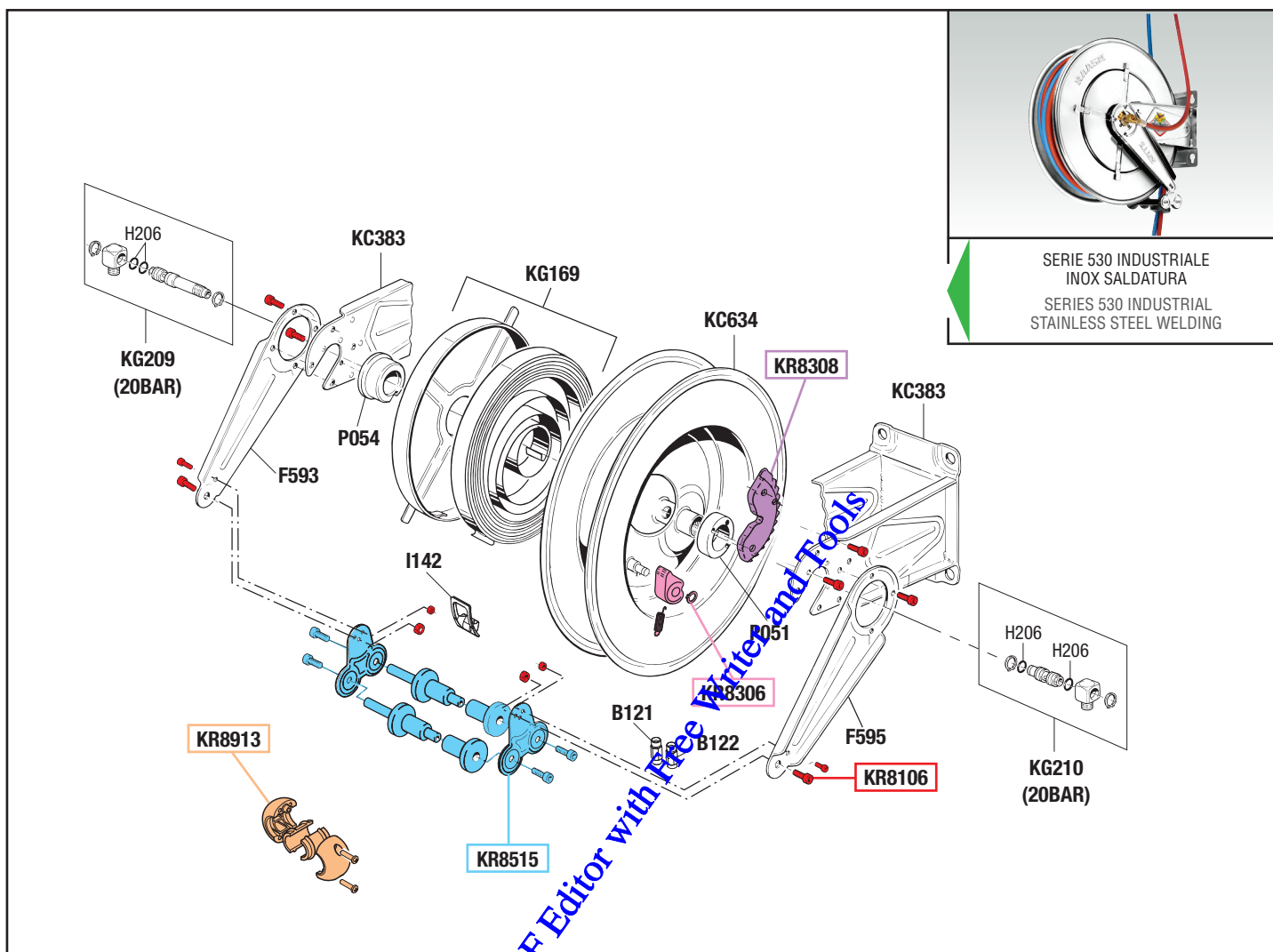

tutti i diritti riservati - all rights reserved

GUIDA RICAMBI - SPARE PARTS GUIDE

KIT RICAMBI

OGNI KIT SOTTO RIPORTATO COMPRENDE I RICAMBI EVIDENZIATI CON LO STESSO COLORE E LE RELATIVE GUARNIZIONI. QUESTI RICAMBI NON SONO FORNIBILI SEPARATAMENTE TRANNE QUELLI CODIFICATI.

SPARE PARTS KITS

EACH KIT SHOWN WITH THE SAME COLOR INCLUDES ALSO THE GASKETS. THE SPARE PARTS INCLUDED IN THE KIT CAN'T BE SUPPLIED SEPARATELY EXCEPT THOSE SHOWN WITH A PROPER CODE.

CODICE CODE	DESCRIZIONE DESCRIPTION	Q.TÀ QTY
KR8106	SET VITI ARROTOLATORE SET OF SCREWS FOR HOSE REEL	1
KR8306	DENTE D'ARRESTO DETENT	1
KR8308	KIT CREMAGLIERA RACK KIT	1
KR8515	KIT PORTA RULLI ROLLERS HOLDING KIT	1
KR8913	TAMPONE FERMATUBO HOSE STOP	1

ELENCO RICAMBI FORNIBILI SINGOLARMENTE

LIST OF SPARE PARTS WHICH CAN BE SUPPLIED SEPARATELY

CODICE CODE	DESCRIZIONE DESCRIPTION	Q.TÀ QTY
B121	NIPPLO DESTRO RIGHT ADAPTOR	1
B122	NIPPLO DESTRO RIGHT ADAPTOR	1
F593	BRACCIO ORIENTABILE SWINGING ARM	1
F595	BRACCIO ORIENTABILE SWINGING ARM	1
I142	INSERTO FORO USCITA TUBO HOSE OUTLET PROTECTION	1
KC383	SUPPORTO ARROTOLATORE HOSE REEL SUPPORT	1
KC634	TAMBURO DRUM	1
KG169	CARTER-MOLLA COVER SPRING-GROUP	1
KG209	SNODO SINISTRO 20 BAR LEFT JOINT 20 BAR	1
KG210	SNODO DESTRO 20 BAR RIGHT JOINT 20 BAR	1
P051	BOCCOLA LATO CREMAGLIERA BUSH	1
P054	BOCCOLA LATO MOLLA BUSH	1

ELENCO GUARNIZIONI SNODI

JOINTS GASKETS LIST

CODICE CODE	DESCRIZIONE DESCRIPTION	Q.TÀ QTY
H206	O-RING 3043 "VITON" O-RING 3043 "VITON"	4



Art. 8532.800 Mod. 532 GAS



VISTA ESPLOSA - EXPLODED VIEW

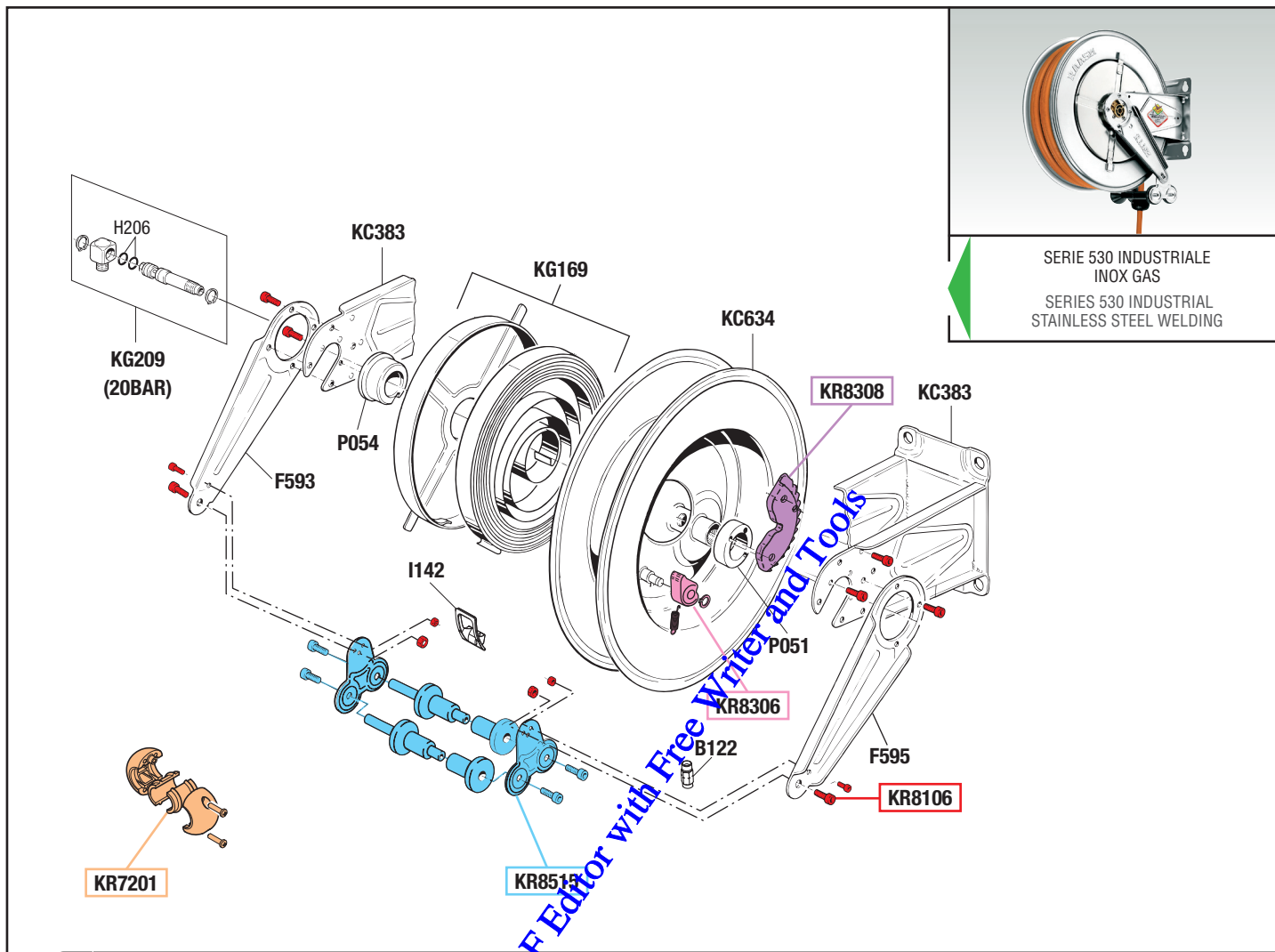

tutti i diritti riservati - all rights reserved

GUIDA RICAMBI - SPARE PARTS GUIDE

KIT RICAMBI
OGNI KIT SOTTO RIPORTATO COMPRENDE I RICAMBI EVIDENZIATI CON LO STESSO COLORE E LE RELATIVE GUARNIZIONI. QUESTI RICAMBI NON SONO FORNIBILI SEPARATAMENTE TRANNE QUELLI CODIFICATI.

SPARE PARTS KITS
EACH KIT SHOWN WITH THE SAME COLOR INCLUDES ALSO THE GASKETS. THE SPARE PARTS INCLUDED IN THE KIT CAN'T BE SUPPLIED SEPARATELY EXCEPT THOSE SHOWN WITH A PROPER CODE.

CODICE CODE	DESCRIZIONE DESCRIPTION	Q.TÀ QTY
KR7201	TAMPONE FERMATUBO HOSE STOP	1
KR8106	SET VITI ARROTOLATORE SET OF SCREWS FOR HOSEREEL	1
KR8306	DENTE D'ARRESTO DETENT	1
KR8308	KIT CREMAGLIERA RACK KIT	1
KR8515	KIT PORTA RULLI ROLLERS HOLDING KIT	1

ELENCO RICAMBI FORNIBILI SINGOLARMENTE
LIST OF SPARE PARTS WHICH CAN BE SUPPLIED SEPARATELY

CODICE CODE	DESCRIZIONE DESCRIPTION	Q.TÀ QTY
B122	NIPPLES DESTRO RIGHT ADAPTOR	1
F593	BRACCIO ORIENTABILE SWINGING ARM	1
F595	BRACCIO ORIENTABILE SWINGING ARM	1
I142	INSERTO FORO USCITA TUBO HOSE OUTLET PROTECTION	1
KC383	SUPPORTO ARROTOLATORE HOSEREEL SUPPORT	1
KC634	TAMBURO DRUM	1
KG169	CARTER-MOLLA COVER SPRING-GROUP	1
KG209	SNODO SINISTRO 20 BAR LEFT JOINT 20 BAR	1
P051	BOCCOLA LATO CREMAGLIERA BUSH	1
P054	BOCCOLA LATO MOLLA BUSH	1

ELENCO GUARNIZIONI SNODI
JOINTS GASKETS LIST

CODICE CODE	DESCRIZIONE DESCRIPTION	Q.TÀ QTY
H206	O-RING 3043 "VITON" O-RING 3043 "VITON"	2



Art. 8536.200 Mod. 536-S316L-100 bar



VISTA ESPLOSA - EXPLODED VIEW

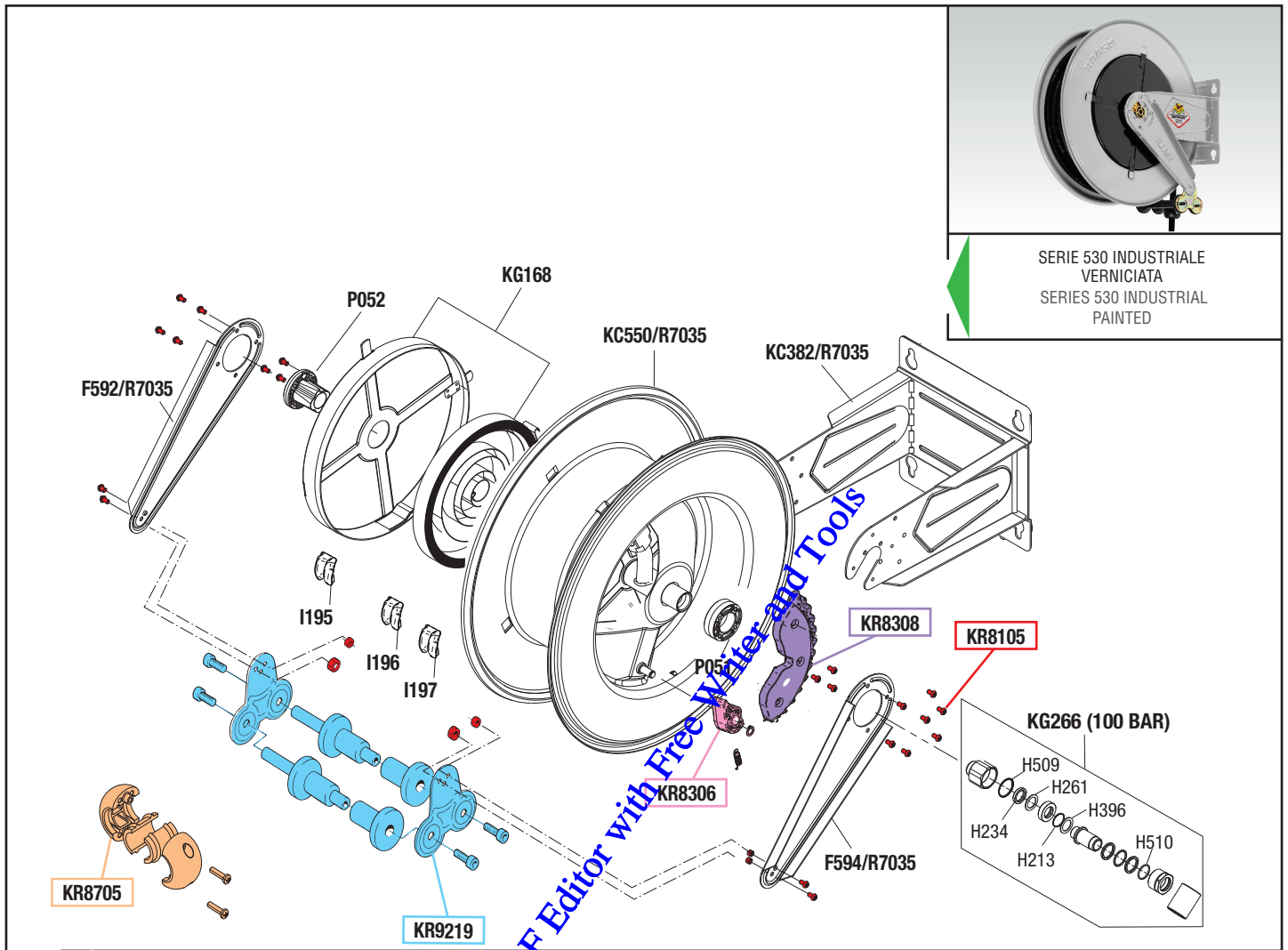

tutti i diritti riservati - all rights reserved

GUIDA RICAMBI - SPARE PARTS GUIDE

KIT RICAMBI

OGNI KIT SOTTO RIPORTATO COMPRENDE I RICAMBI EVIDENZIATI CON LO STESSO COLORE E LE RELATIVE GUARNIZIONI. QUESTI RICAMBI NON SONO FORNIBILI SEPARATAMENTE TRANNE QUELLI CODIFICATI.

SPARE PARTS KITS

EACH KIT SHOWN WITH THE SAME COLOR INCLUDES ALSO THE GASKETS. THE SPARE PARTS INCLUDED IN THE KIT CAN'T BE SUPPLIED SEPARATELY EXCEPT THOSE SHOWN WITH A PROPER CODE.

CODICE CODE	DESCRIZIONE DESCRIPTION	Q.TÀ QTY
KR8105	SET VITI ARROTOLATORE SET OF SCREWS FOR HOSEREEL	1
KR8306	DENTE D'ARRESTO DETENT	1
KR8308	KIT CREMAGLIERA RACK KIT	1
KR8705	TAMPONE FERMATUBO HOSE STOP	1
KR9219	KIT PORTA RULLI ARROTOLATORE ROLLERS HOLDING KIT FOR HOSEREEL	1

ELENCO RICAMBI FORNIBILI SINGOLARMENTE

LIST OF SPARE PARTS WHICH CAN BE SUPPLIED SEPARATELY

CODICE CODE	DESCRIZIONE DESCRIPTION	Q.TÀ QTY
F592/R7035	BRACCIO ORIENTABILE SWINGING ARM	1
F594/R7035	BRACCIO ORIENTABILE SWINGING ARM	1
I195	INSERTO USCITA TUBO HOSE OUTLET PROTECTION	1
I196	INSERTO USCITA TUBO HOSE OUTLET PROTECTION	1
I197	INSERTO USCITA TUBO HOSE OUTLET PROTECTION	1
KC382/R7035	SUPPORTO ARROTOLATORE HOSEREEL SUPPORT	1
KC550/R7035	TAMBURO 510 510 HOSEREEL DRUM	1
KG168	CARTER-MOLLA COVER-SPRING GROUP	1
KG266	SNODO INOX AISI 316L AISI 316L S. STEEL HOSEREEL JOINT	1
P051	BOCCOLA LATO CREMAGLIERA BUSH	1
P052	BOCCOLA LATO MOLLA BUSH	1

ELENCO GUARNIZIONI SNODI

JOINTS GASKETS LIST

CODICE CODE	DESCRIZIONE DESCRIPTION	Q.TÀ QTY
H213	O-RING 20 O-RING 20	1
H234	GASKET GUARNIZIONE "VITON 90 SH"	1
H261	WASHER RONDELLA "PTFE"	1
H396	WASHER RONDELLA "PTFE"	1
H509	O-RING 2131 "VITON" O-RING 2131 "VITON"	1
H510	O-RING 2106 "VITON" O-RING 2106 "VITON"	1



Art. 8537.200 Mod. 537-S316L-100 bar



VISTA ESPLOSA - EXPLODED VIEW

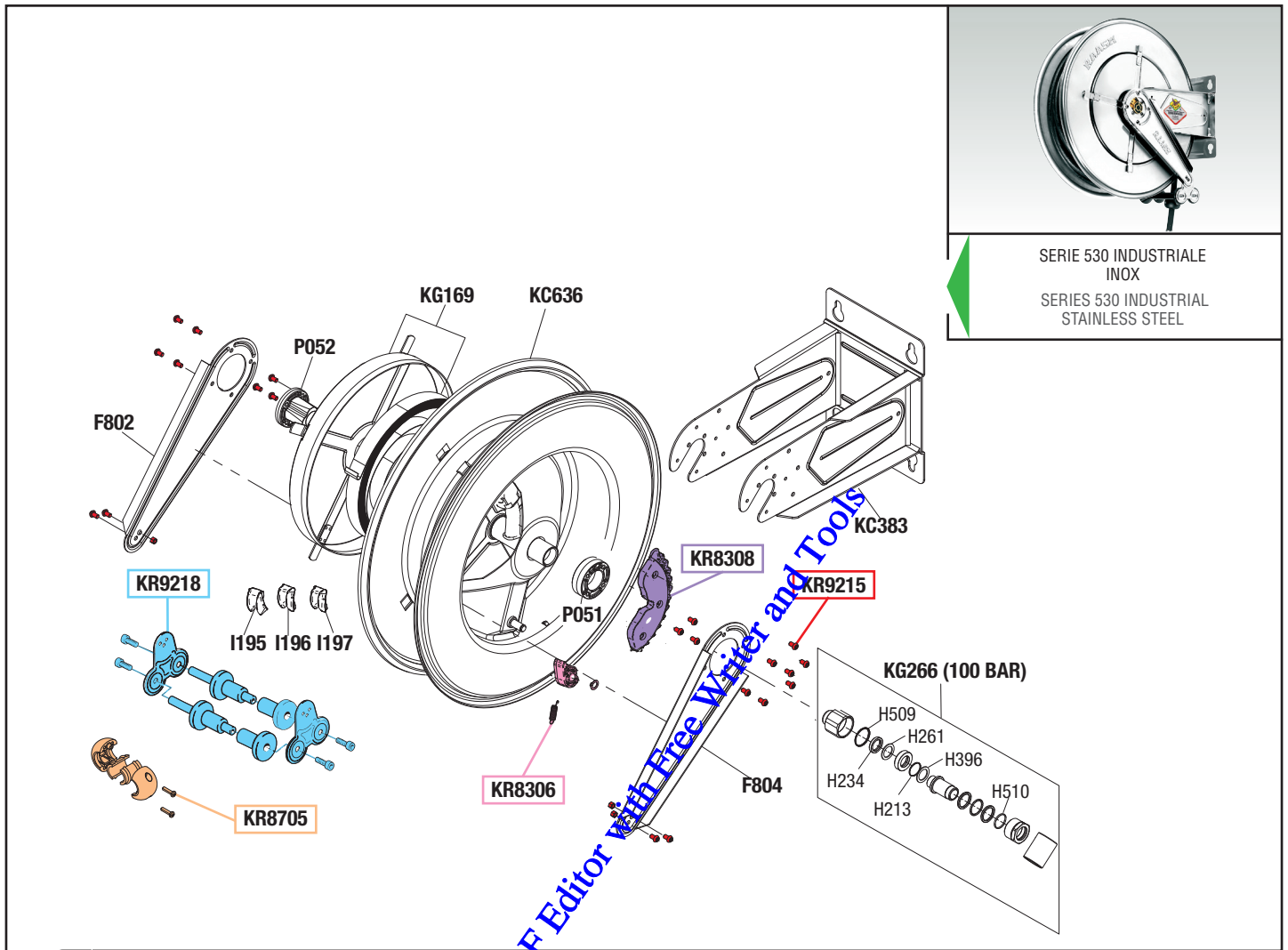

tutti i diritti riservati - all rights reserved

GUIDA RICAMBI - SPARE PARTS GUIDE

KIT RICAMBI

OGNI KIT SOTTO RIPORTATO COMPRENDE I RICAMBI EVIDENZIATI CON LO STESSO COLORE E LE RELATIVE GUARNIZIONI. QUESTI RICAMBI NON SONO FORNIBILI SEPARATAMENTE TRANNE QUELLI CODIFICATI.

SPARE PARTS KITS

EACH KIT SHOWN WITH THE SAME COLOR INCLUDES ALSO THE GASKETS. THE SPARE PARTS INCLUDED IN THE KIT CAN'T BE SUPPLIED SEPARATELY EXCEPT THOSE SHOWN WITH A PROPER CODE.

CODICE CODE	DESCRIZIONE DESCRIPTION	Q.TÀ QTY
KR8306	DENTE D'ARRESTO DETENT	1
KR8308	KIT CREMAGLIERA RACK KIT	1
KR8705	TAMPONE FERMATUBO HOSE STOP	1
KR9215	SET VITI ARROTOLATORE SET OF SCREWS FOR HOSE REEL	1
KR9218	KIT PORTA RULLI ARROTOLATORE ROLLERS HOLDING KIT FOR HOSE REEL	1

ELENCO RICAMBI FORNIBILI SINGOLARMENTE

LIST OF SPARE PARTS WHICH CAN BE SUPPLIED SEPARATELY

CODICE CODE	DESCRIZIONE DESCRIPTION	Q.TÀ QTY
F802	BRACCIO ORIENTABILE SWINGING ARM	1
F804	BRACCIO ORIENTABILE SWINGING ARM	1
I195	INSERTO USCITA TUBO Ø 34-38 HOSE OUTLET PROTECTION	1
I196	INSERTO USCITA TUBO Ø 30-34 HOSE OUTLET PROTECTION	1
I197	INSERTO USCITA TUBO Ø 26-30 HOSE OUTLET PROTECTION	1
KC383	STAFFA BRACKET	1
KC636	TAMBURO 530 530 HOSE REEL DRUM	1
KG169	CARTER-MOLLA COVER SPRING-GROUP	1
KG266	SNODO INOX AISI 316L - 100 BAR AISI 316L S.STEEL HOSE REEL JOINT- 100 BAR	1
P051	BOCCOLA LATO CREMAGLIERA BUSH	1
P052	BOCCOLA LATO MOLLA BUSH	1

ELENCO GUARNIZIONI SNODI

JOINTS GASKETS LIST

CODICE CODE	DESCRIZIONE DESCRIPTION	Q.TÀ QTY
H213	O-RING 2087 "VITON" O-RING 2087 "VITON"	1
H234	O-RING 2131 "VITON" O-RING 2131 "VITON"	1
H261	RONDELLA IN PTFE PTFE WASHER	1
H396	RONDELLA IN PTFE PTFE WASHER	1
H509	O-RING 3043 "VITON" O-RING 3043 "VITON"	1



Art. 8540.100 Mod. 540-20 bar - Art. 8540.200 Mod. 540-100 bar
 Art. 8540.400 Mod. 540-150 bar



VISTA ESPLOSA - EXPLODED VIEW

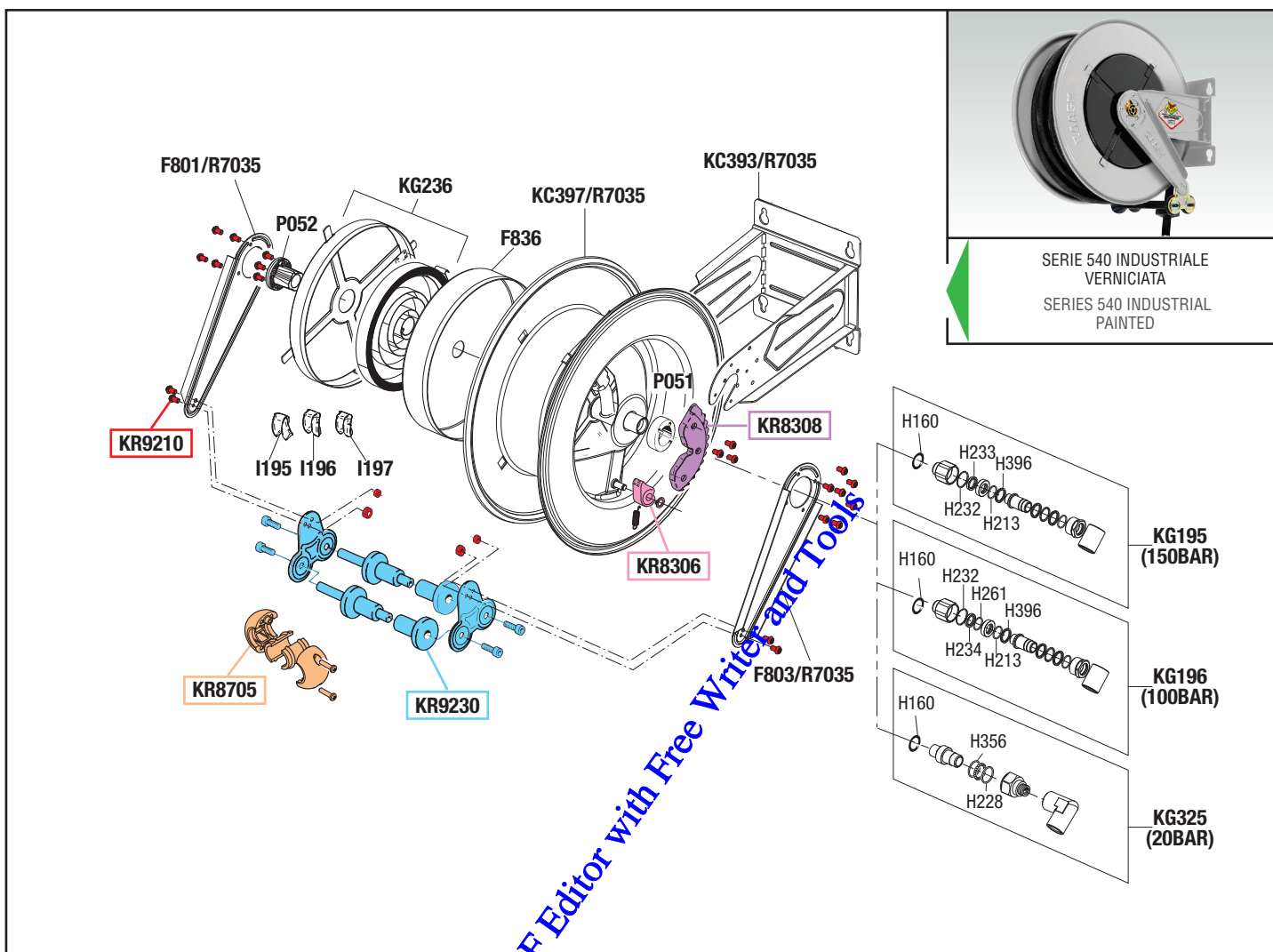

SERIE 540 INDUSTRIALE
 VERNICIATA
 SERIES 540 INDUSTRIAL
 PAINTED

GUIDA RICAMBI - SPARE PARTS GUIDE

KIT RICAMBI
 OGNI KIT SOTTO RIPORTATO COMPRENDE I RICAMBI EVIDENZIATI CON LO STESSO COLORE E LE RELATIVE GUARNIZIONI. QUESTI RICAMBI NON SONO FORNIBILI SEPARATAMENTE TRANNE QUELLI CODIFICATI.

SPARE PARTS KITS
 EACH KIT SHOWN WITH THE SAME COLOR INCLUDES ALSO THE GASKETS. THE SPARE PARTS INCLUDED IN THE KIT CAN'T BE SUPPLIED SEPARATELY EXCEPT THOSE SHOWN WITH A PROPER CODE.

CODICE CODE	DESCRIZIONE DESCRIPTION	Q.TÀ QTY
KR8306	DENTE D'ARRESTO DETENT	1
KR8308	KIT CREMAGLIERA RACK KIT	1
KR8705	TAMPONE FERMATUBO HOSE STOP	1
KR9210	SET VITI ARROTOLATORE SET OF SCREWS FOR HOSE REEL	1
KR9230	KIT PORTA RULLI ARROTOLATORE ROLLERS HOLDING KIT FOR HOSE REEL	1

ELENCO RICAMBI FORNIBILI SINGOLARMENTE
 LIST OF SPARE PARTS WHICH CAN BE SUPPLIED SEPARATELY

CODICE CODE	DESCRIZIONE DESCRIPTION	Q.TÀ QTY
F801/R7035	BRACCIO ORIENTABILE SWINGING ARM	1
F803/R7035	BRACCIO ORIENTABILE SWINGING ARM	1
F836	CARTER COVER	1
I195	INSERTO USCITA TUBO Ø34-38 HOSE OUTLET PROTECTION	1
I196	INSERTO USCITA TUBO Ø30-34 HOSE OUTLET PROTECTION	1
I197	INSERTO USCITA TUBO Ø26-30 HOSE OUTLET PROTECTION	1
KC393/R7035	SUPPORTO ARROTOLATORE HOSE REEL SUPPORT	1
KC397/R7035	TAMBURO 510 510 HOSE REEL DRUM	1
KG236	CARTER-MOLLA COVER-SPRING GROUP	1
KG195	SNODO OLIO 150 BAR JOINT OIL 150 BAR	1
KG196	SNODO ACQUA 100 BAR JOINT WATER 100 BAR	1
KG325	SNODO ARIA-ACQUA 20 BAR JOINT AIR-WATER 20 BAR	1
P051	BOCCOLA LATO CREMAGLIERA BUSH	1
P052	BOCCOLA LATO MOLLA BUSH	1

ELENCO GUARNIZIONI SNODI
 JOINTS GASKETS LIST

CODICE CODE	DESCRIZIONE DESCRIPTION	Q.TÀ QTY
H160	O-RING 2093 O-RING 2093	1
H213	GUARNIZIONE OR 2087 VITON GASKET	1
H228	O-RING 4112 "VITON" O-RING 4112 "VITON"	1
H232	GUARNIZIONE GASKET	1
H233	GUARNIZIONE GASKET	1
H234	GUARN. OR 2131 DI 087 VITON GASKET	1
H261	RONDELLA IN PTFE PTFE WASHER	1
H356	O-RING 3106 "VITON" O-RING 3106 "VITON"	1
H396	RONDELLA IN PTFE PTFE WASHER	1

tutti i diritti riservati - all rights reserved



Art. 8540.105 Mod. 540-1/2"-20 bar - Art. 8540.205 Mod. 540-1/2"-100 bar
 Art. 8540.300 Mod. 540-200 bar - Art. 8540.350 Mod. 540-400 bar
 Art. 8540.405 Mod. 540-1/2"-150 bar - Art. 8540.500 Mod. 540-600 bar



VISTA ESPLOSA - EXPLODED VIEW

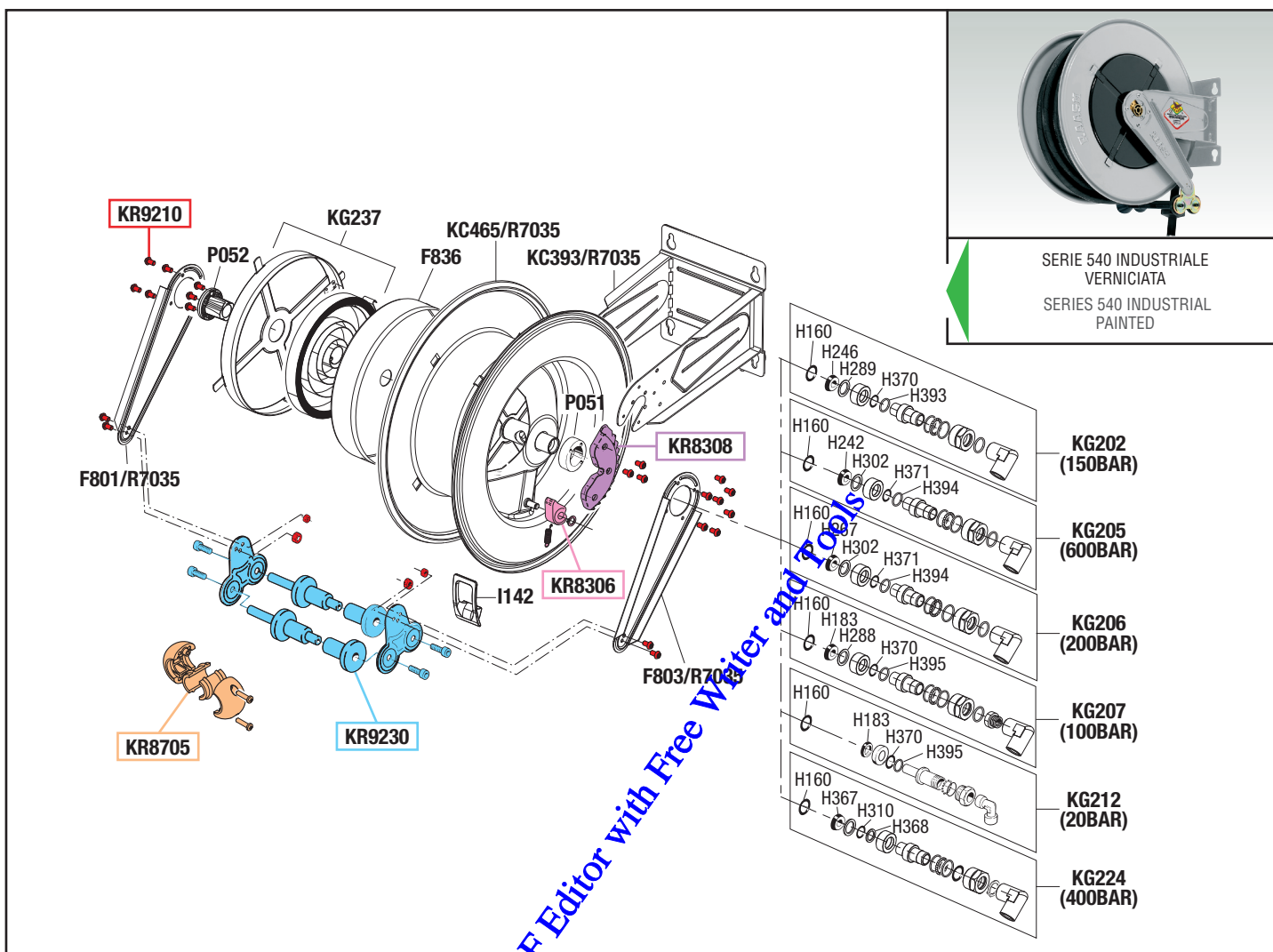

SERIE 540 INDUSTRIALE
 VERNICIATA
 SERIES 540 INDUSTRIAL
 PAINTED

GUIDA RICAMBI - SPARE PARTS GUIDE

KIT RICAMBI
 OGNI KIT SOTTO RIPORTATO COMPRENDE I RICAMBI EVIDENZIATI CON LO STESSO COLORE E LE RELATIVE GUARNIZIONI. QUESTI RICAMBI NON SONO FORNIBILI SEPARATAMENTE TRANNE QUELLI CODIFICATI.
SPARE PARTS KITS
 EACH KIT SHOWN WITH THE SAME COLOR INCLUDES ALSO THE GASKETS. THE SPARE PARTS INCLUDED IN THE KIT CAN'T BE SUPPLIED SEPARATELY EXCEPT THOSE SHOWN WITH A PROPER CODE.

CODICE CODE	DESCRIZIONE DESCRIPTION	Q.TÀ QTY
KR8306	DENTE D'ARRESTO DETENT	1
KR8308	KIT CREMAGLIERA RACK KIT	1
KR8705	TAMPONE FERMATUBO HOSE STOP	1
KR9210	SET VITI ARROTOLATORE SET OF SCREWS FOR HOSEREEL	1
KR9230	KIT PORTA RULLI ARROTOLATORE ROLLERS HOLDING KIT FOR HOSEREEL	1

ELENCO RICAMBI FORNIBILI SINGOLARMENTE
LIST OF SPARE PARTS WHICH CAN BE SUPPLIED SEPARATELY

CODICE CODE	DESCRIZIONE DESCRIPTION	Q.TÀ QTY
F801/R7035	BRACCIO ORIENTABILE SWINGING ARM	1
F803/R7035	BRACCIO ORIENTABILE SWINGING ARM	1
F836	CARTER COVER	1
I142	INSERTO USCITA TUBO HOSE OUTLET PROTECTION	1
KC393/R7035	SUPPORTO ARROTOLATORE HOSEREEL SUPPORT	1
KC465/R7035	TAMBURO 510 510 HOSEREEL DRUM	1
KG202	SNODO OLIO 150 BAR JOINT OIL 150 BAR	1
KG205	SNODO GRASSO 600 BAR JOINT GREASE 600 BAR	1
KG206	SNODO ACQUA 200 BAR JOINT WATER 200 BAR	1
KG207	SNODO ACQUA 100 BAR JOINT WATER 100 BAR	1
KG212	SNODO ARIA-ACQUA 20 BAR JOINT AIR-WATER 20 BAR	1
KG224	SNODO ACQUA 400 BAR JOINT WATER 400 BAR	1
KG237	CARTER-MOLLA COVER SPRING-GROUP	1
P051	BOCCOLA LATO CREMAGLIERA BUSH	1
P052	BOCCOLA LATO MOLLA BUSH	1

ELENCO GUARNIZIONI SNODI
JOINTS GASKETS LIST

CODICE CODE	DESCRIZIONE DESCRIPTION	Q.TÀ QTY
H160	O-RING 2093 O-RING 2093	1
H183	GUARNIZIONE GASKET	1
H242	GUARNIZIONE M4 1810-PUR95 GASKET	1
H246	GUARNIZ. MAD2060/2-PUR95 GASKET	1
H267	GUARNIZIONE VITON 90SH GASKET	1
H288	RONDELLA IN PTFE PTFE WASHER	1
H289	RONDELLA IN PTFE PTFE WASHER	1
H302	RONDELLA IN PTFE PTFE WASHER	1
H310	GUARNIZIONE OR 112 VITON GASKET	1
H367	GUARNIZIONE GASKET	1
H368	RONDELLA IN PTFE PTFE WASHER	1
H370	GUARNIZIONE OR 2062 VITON GASKET	1
H371	GUARNIZIONE OR 2037 VITON GASKET	1
H393	RONDELLA IN PTFE PTFE WASHER	1
H394	RONDELLA IN PTFE PTFE WASHER	1
H395	RONDELLA IN PTFE PTFE WASHER	1

tutti i diritti riservati - all rights reserved



Art. 8540.700 Mod. 540 BIN



VISTA ESPLOSA - EXPLODED VIEW

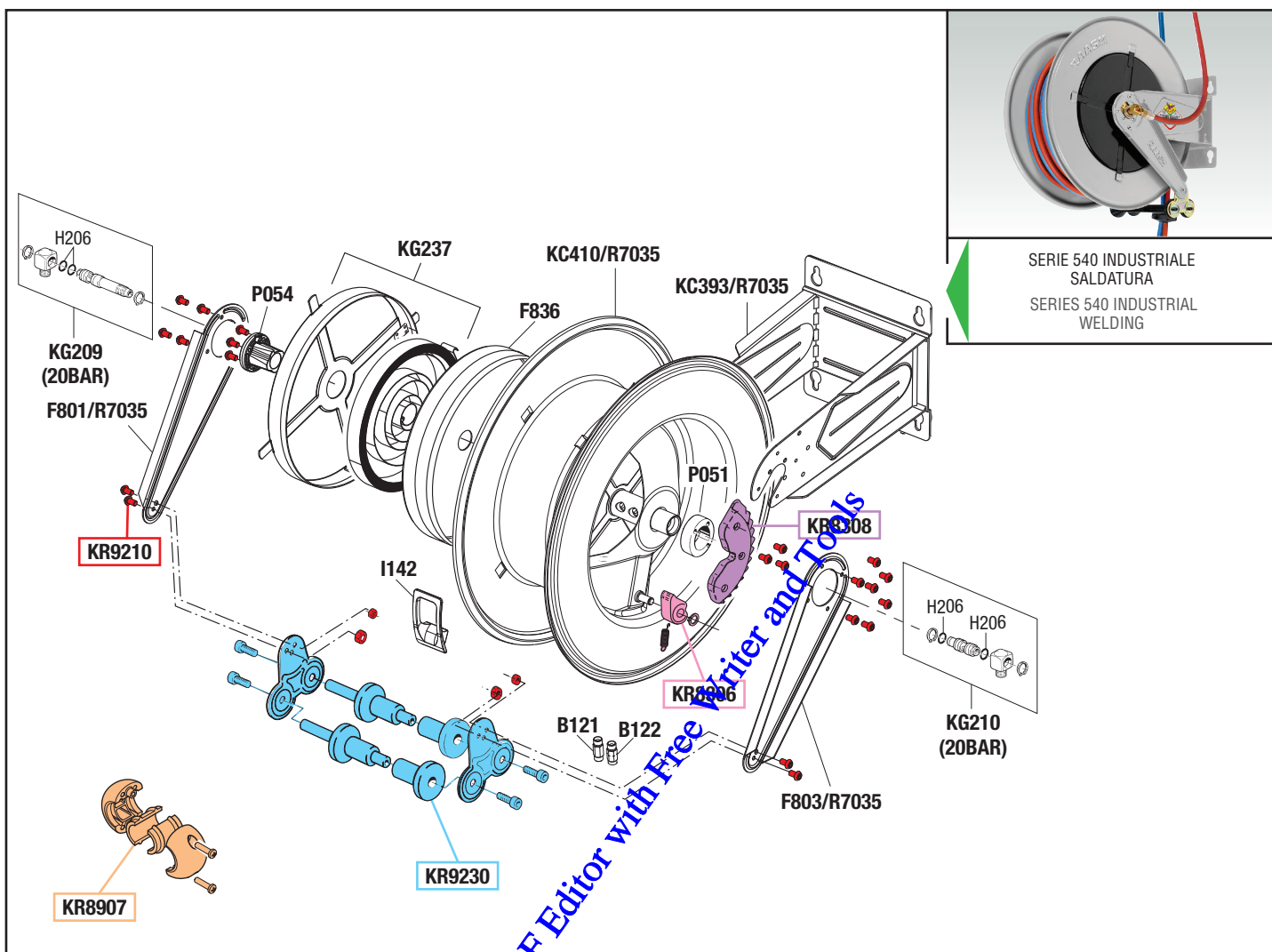

tutti i diritti riservati - all rights reserved

GUIDA RICAMBI - SPARE PARTS GUIDE

KIT RICAMBI

OGNI KIT SOTTO RIPORTATO COMPRENDE I RICAMBI EVIDENZIATI CON LO STESSO COLORE E LE RELATIVE GUARNIZIONI. QUESTI RICAMBI NON SONO FORNIBILI SEPARATAMENTE TRANNE QUELLI CODIFICATI.

SPARE PARTS KITS

EACH KIT SHOWN WITH THE SAME COLOR INCLUDES ALSO THE GASKETS. THE SPARE PARTS INCLUDED IN THE KIT CAN'T BE SUPPLIED SEPARATELY EXCEPT THOSE SHOWN WITH A PROPER CODE.

CODICE CODE	DESCRIZIONE DESCRIPTION	Q.TÀ QTY
KR8306	DENTE D'ARRESTO DETENT	1
KR8308	KIT CREMAGLIERA RACK KIT	1
KR8907	TAMPONE FERMATUBO HOSE STOP	1
KR9210	SET VITI ARROTOLATORE SET OF SCREWS FOR HOSE REEL	1
KR9230	KIT PORTA RULLI ARROTOLATORE ROLLERS HOLDING KIT FOR HOSE REEL	1

ELENCO RICAMBI FORNIBILI SINGOLARMENTE

LIST OF SPARE PARTS WHICH CAN BE SUPPLIED SEPARATELY

CODICE CODE	DESCRIZIONE DESCRIPTION	Q.TÀ QTY
B121	NIPPLES SINISTRO LEFT ADAPTOR	1
B122	NIPPLES DESTRO RIGHT ADAPTOR	1
F801/R7035	BRACCIO ORIENTABILE SWINGING ARM	1
F803/R7035	BRACCIO ORIENTABILE SWINGING ARM	1
F836	CARTER COVER	1
I142	INSERTO USCITA TUBO HOSE OUTLET PROTECTION	1
KC393/R7035	SUPPORTO ARROTOLATORE HOSE REEL SUPPORT	1
KC410/R7035	TAMBURO 510 510 HOSE REEL DRUM	1
KG237	CARTER-MOLLA COVER SPRING-GROUP	1
KG209	SNODO SINISTRO 20 BAR LEFT JOINT 20 BAR	1
KG210	SNODO DESTRO 20 BAR RIGHT JOINT 20 BAR	1
P051	BOCCOLA LATO CREMAGLIERA BUSH	1
P054	BOCCOLA LATO MOLLA BUSH	1

ELENCO GUARNIZIONI SNODI

JOINTS GASKETS LIST

CODICE CODE	DESCRIZIONE DESCRIPTION	Q.TÀ QTY
H206	GUARNIZIONE OR 3043 VITON GASKET	4



Art. 8540.800 Mod. 540 GAS



VISTA ESPLOSA - EXPLODED VIEW

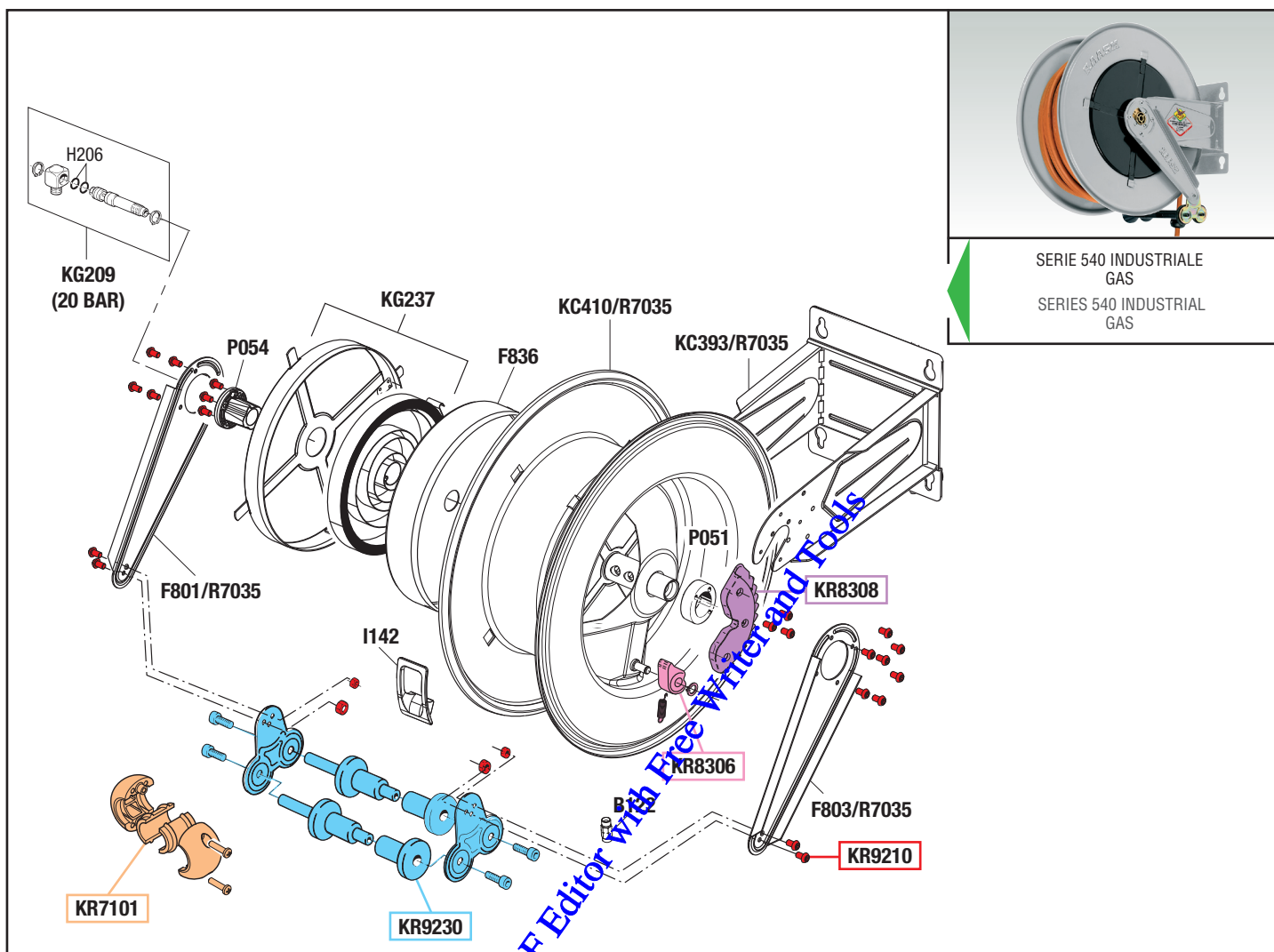

SERIE 540 INDUSTRIALE GAS
SERIES 540 INDUSTRIAL GAS

GUIDA RICAMBI - SPARE PARTS GUIDE

KIT RICAMBI
OGNI KIT SOTTO RIPORTATO COMPRENDE I RICAMBI EVIDENZIATI CON LO STESSO COLORE E LE RELATIVE GUARNIZIONI. QUESTI RICAMBI NON SONO FORNIBILI SEPARATAMENTE TRANNE QUELLI CODIFICATI.

SPARE PARTS KITS
EACH KIT SHOWN WITH THE SAME COLOR INCLUDES ALSO THE GASKETS. THE SPARE PARTS INCLUDED IN THE KIT CAN'T BE SUPPLIED SEPARATELY EXCEPT THOSE SHOWN WITH A PROPER CODE.

CODICE CODE	DESCRIZIONE DESCRIPTION	Q.TÀ QTY
KR7101	TAMPONE FERMATUBO HOSE STOP	1
KR8306	DENTE D'ARRESTO DETENT	1
KR8308	KIT CREMAGLIERA RACK KIT	1
KR9210	SET VITI ARROTOLATORE SET OF SCREWS FOR HOSEREEL	1
KR9230	KIT PORTA RULLI ARROTOLATORE ROLLERS HOLDING KIT FOR HOSEREEL	1

ELENCO RICAMBI FORNIBILI SINGOLARMENTE
LIST OF SPARE PARTS WHICH CAN BE SUPPLIED SEPARATELY

CODICE CODE	DESCRIZIONE DESCRIPTION	Q.TÀ QTY
B122	NIPPES SINISTRO LEFT ADAPTOR	1
F801/R7035	BRACCIO ORIENTABILE SWINGING ARM	1
F803/R7035	BRACCIO ORIENTABILE SWINGING ARM	1
F836	CARTER COVER	1
I142	INSERTO FORO USCITA TUBO HOSE OUTLET PROTECTION	1
KC393/R7035	SUPPORTO ARROTOLATORE HOSEREEL SUPPORT	1
KC410/R7035	TAMBURO 510 510 HOSEREEL DRUM	1
KG209	SNODO SX 20 BAR HOSEREEL JOINT	1
KG237	CARTER-MOLLA COVER-SPRING GROUP	1
P051	BOCCOLA LATO CREMAGLIERA BUSH	1
P054	BOCCOLA LATO MOLLA BUSH	1

ELENCO GUARNIZIONI SNODI
JOINTS GASKETS LIST

CODICE CODE	DESCRIZIONE DESCRIPTION	Q.TÀ QTY
H206	O-RING 3043 VITON O-RING 3043 VITON	2

tutti i diritti riservati - all rights reserved



Art. 8540.5000 Mod. 540-2X700 bar

VISTA ESPLOSA - EXPLODED VIEW

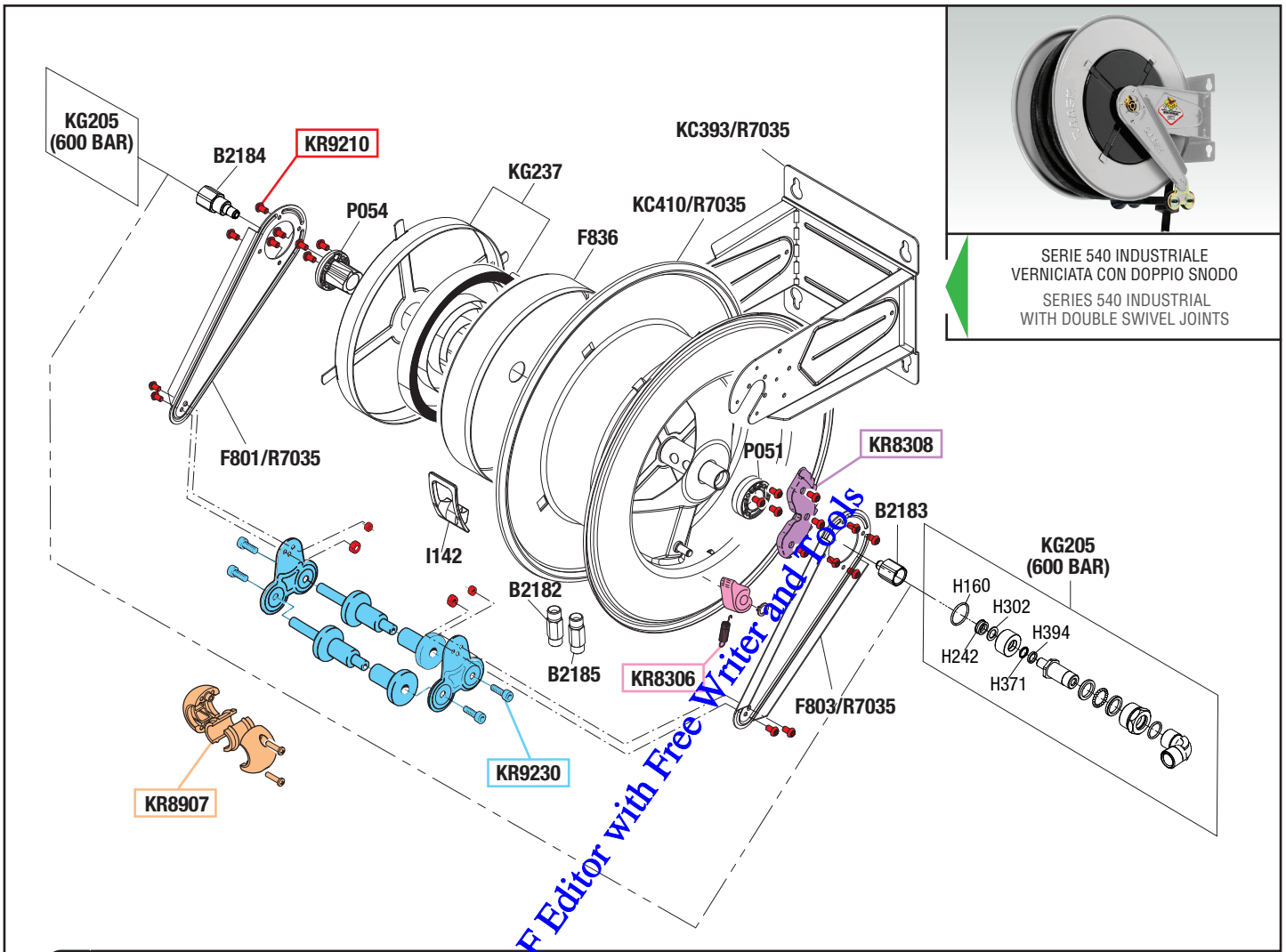

GUIDA RICAMBI - SPARE PARTS GUIDE

KIT RICAMBI
OGNI KIT SOTTO RIPORTATO COMPRENDE I RICAMBI EVIDENZIATI CON LO STESSO COLORE E LE RELATIVE GUARNIZIONI. QUESTI RICAMBI NON SONO FORNIBILI SEPARATAMENTE TRANNE QUELLI CODIFICATI.

SPARE PARTS KITS
EACH KIT SHOWN WITH THE SAME COLOR INCLUDES ALSO THE GASKETS. THE SPARE PARTS INCLUDED IN THE KIT CAN'T BE SUPPLIED SEPARATELY EXCEPT THOSE SHOWN WITH A PROPER CODE.

CODICE CODE	DESCRIZIONE DESCRIPTION	Q.TÀ QTY
KR8306	DENTE D'ARRESTO DETENT	1
KR8308	KIT CREMAGLIERA RACK KIT	1
KR8907	TAMPONE FERMATUBO HOSE STOP	1
KR9210	SET VITI ARROTOLATORE SET OF SCREWS FOR HOSE REEL	1
KR9230	KIT PORTA RULLI ARROTOLATORE ROLLERS HOLDING KIT FOR HOSE REEL	1

ELENCO RICAMBI FORNIBILI SINGOLARMENTE
LIST OF SPARE PARTS WHICH CAN BE SUPPLIED SEPARATELY

CODICE CODE	DESCRIZIONE DESCRIPTION	Q.TÀ QTY
B2182	NIPPES SINISTRO LEFT ADAPTOR	1
B2183	ADATTATORE SNODO SWIVEL JOINT ADAPTOR	1
B2184	ADATTATORE SNODO LATO MOLLA SWIVEL JOINT ADAPTOR	1
B2185	NIPPLE SINISTRO LEFT ADAPTOR	1
F801/R7035	BRACCIO ORIENTABILE SWINGING ARM	1
F803/R7035	BRACCIO ORIENTABILE SWINGING ARM	1
I142	INSERTO USCITA TUBO HOSE OUTLET PROTECTION	1
KC393/R7035	SUPPORTO ARROTOLATORE HOSE REEL SUPPORT	1
KC410/R7035	TAMBURO 510 510 HOSE REEL DRUM	1
KG205	SNODO GRASSO 600 BAR JOINT GREASE 600 BAR	2
KG237	CARTER-MOLLA COVER SPRING-GROUP	1
P051	BOCCOLA LATO CREMAGLIERA BUSH	1
P054	BOCCOLA LATO MOLLA BUSH	1

ELENCO GUARNIZIONI SNODI
JOINTS GASKETS LIST

CODICE CODE	DESCRIZIONE DESCRIPTION	Q.TÀ QTY
H160	O-RING 2093 O-RING 2093	1
H242	GUARNIZIONE M41810-PUR 95 GASKET	1
H302	RONDELLA IN PTFE PTFE WASHER	1
H371	GUARN. OR 2037VITON GASKET VITON	1
H394	RONDELLA IN PTFE PTFE GASKET	1

tutti i diritti riservati - all rights reserved



Art. 8542.100 Mod. 542-1"-20 bar - Art. 8544.200 Mod. 544-1"-100 bar



VISTA ESPLOSA - EXPLODED VIEW

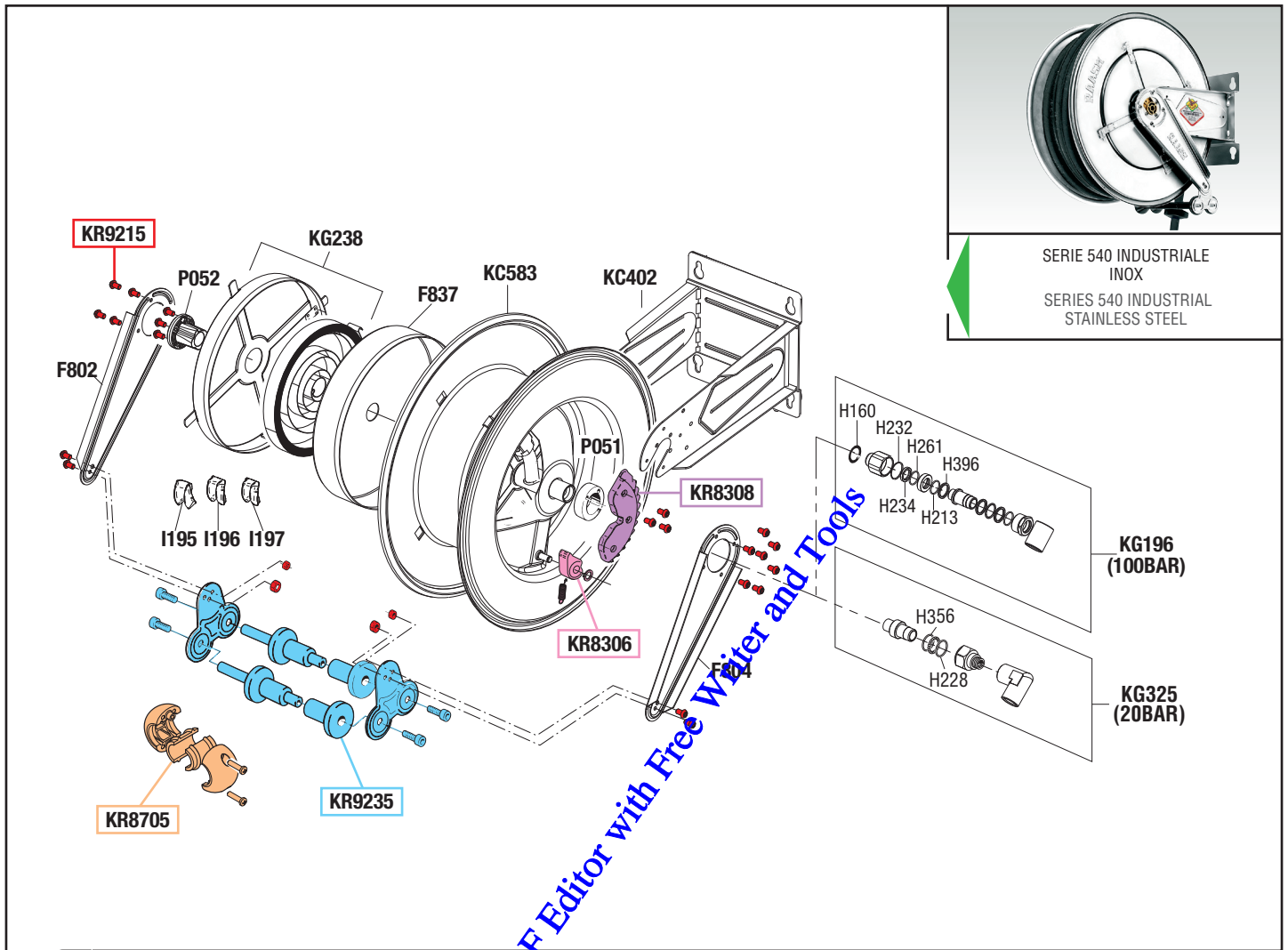

SERIE 540 INDUSTRIALE
INOX
SERIES 540 INDUSTRIAL
STAINLESS STEEL

GUIDA RICAMBI - SPARE PARTS GUIDE

KIT RICAMBI

OGNI KIT SOTTO RIPORTATO COMPRENDE I RICAMBI EVIDENZIATI CON LO STESSO COLORE E LE RELATIVE GUARNIZIONI. QUESTI RICAMBI NON SONO FORNIBILI SEPARATAMENTE TRANNE QUELLI CODIFICATI.

SPARE PARTS KITS

EACH KIT SHOWN WITH THE SAME COLOR INCLUDES ALSO THE GASKETS. THE SPARE PARTS INCLUDED IN THE KIT CAN'T BE SUPPLIED SEPARATELY EXCEPT THOSE SHOWN WITH A PROPER CODE.

CODICE CODE	DESCRIZIONE DESCRIPTION	Q.TÀ QTY
KR8306	DENTE D'ARRESTO DETENT	1
KR8308	KIT CREMAGLIERA RACK KIT	1
KR8705	TAMPONE FERMATUBO HOSE STOP	1
KR9215	SET VITI ARROTOLATORE SET OF SCREWS FOR HOSE REEL	1
KR9235	KIT PORTA RULLI ARROTOLATORE ROLLERS HOLDING KIT FOR HOSE REEL	1

ELENCO RICAMBI FORNIBILI SINGOLARMENTE

LIST OF SPARE PARTS WHICH CAN BE SUPPLIED SEPARATELY

CODICE CODE	DESCRIZIONE DESCRIPTION	Q.TÀ QTY
F802	BRACCIO ORIENTABILE SWINGING ARM	1
F804	BRACCIO ORIENTABILE SWINGING ARM	1
F837	CARTER COVER	1
I195	INSERTO USCITA TUBO Ø34-38 HOSE OUTLET PROTECTION	1
I196	INSERTO USCITA TUBO Ø30-34 HOSE OUTLET PROTECTION	1
I197	INSERTO USCITA TUBO Ø26-30 HOSE OUTLET PROTECTION	1
KC402	SUPPORTO ARROTOLATORE HOSE REEL SUPPORT	1
KC583	TAMBURO 510 510 HOSE REEL DRUM	1
KG196	SNODO ACQUA 100 BAR JOINT WATER 100 BAR	1
KG238	CARTER-MOLLA COVER SPRING-GROUP	1
KG325	SNODO ALTA PORTATA 1" G JOINT HIGH FLOW 1" G	1
P051	BOCCOLA LATO CREMAGLIERA BUSH	1
P052	BOCCOLA LATO MOLLA BUSH	1

ELENCO GUARNIZIONI SNODI

JOINTS GASKETS LIST

CODICE CODE	DESCRIZIONE DESCRIPTION	Q.TÀ QTY
H160	O-RING 2093 O-RING 2093	1
H213	GUARNIZIONE OR 2087 VITON GASKET	1
H228	O-RING 4112 VITON O-RING 4112 VITON	1
H232	GUARNIZIONE OR 2131 GASKET	1
H234	GUARNIZIONE DI 087 VITON GASKET	1
H261	RONDELLA IN PTFE PTFE WASHER	1
H356	O-RING 3106 VITON O-RING 3106 VITON	1
H396	RONDELLA IN PTFE PTFE WASHER	1

tutti i diritti riservati - all rights reserved



Art. 8542.105 Mod. 542-1/2"-20 bar - Art. 8542.500 Mod. 542-600 bar
 Art. 8544.205 Mod. 544-1/2"-100 bar - Art. 8544.300 Mod. 544-200 bar
 Art. 8544.350 Mod. 544-400 bar



VISTA ESPLOSA - EXPLODED VIEW

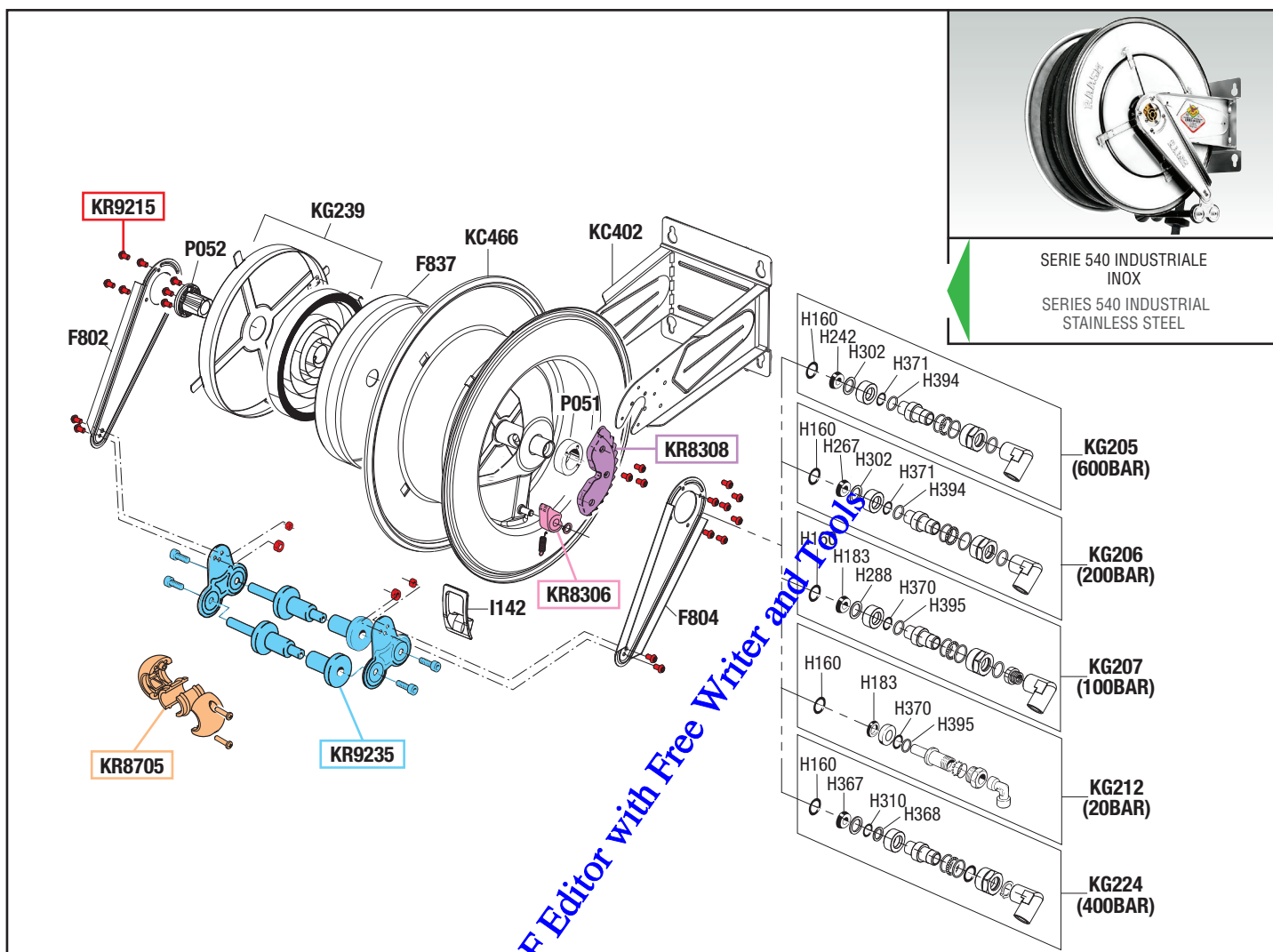

GUIDA RICAMBI - SPARE PARTS GUIDE

KIT RICAMBI

OGNI KIT SOTTO RIPORTATO COMPRENDE I RICAMBI EVIDENZIATI CON LO STESSO COLORE E LE RELATIVE GUARNIZIONI. QUESTI RICAMBI NON SONO FORNIBILI SEPARATAMENTE TRANNE QUELLI CODIFICATI.

SPARE PARTS KITS

EACH KIT SHOWN WITH THE SAME COLOR INCLUDES ALSO THE GASKETS. THE SPARE PARTS INCLUDED IN THE KIT CAN'T BE SUPPLIED SEPARATELY EXCEPT THOSE SHOWN WITH A PROPER CODE.

CODICE CODE	DESCRIZIONE DESCRIPTION	Q.TÀ QTY
KR8306	DENTE D'ARRESTO DETENT	1
KR8308	KIT CREMAGLIERA RACK KIT	1
KR8705	TAMPONE FERMATUBO HOSE STOP	1
KR9215	SET VITI ARROTOLATORE SET OF SCREWS FOR HOSEREEL	1
KR9235	KIT PORTA RULLI ARROTOLATORE ROLLERS HOLDING KIT FOR HOSEREEL	1

ELENCO RICAMBI FORNIBILI SINGOLARMENTE

LIST OF SPARE PARTS WHICH CAN BE SUPPLIED SEPARATELY

CODICE CODE	DESCRIZIONE DESCRIPTION	Q.TÀ QTY
F802	BRACCIO ORIENTABILE SWINGING ARM	1
F804	BRACCIO ORIENTABILE SWINGING ARM	1
F837	CARTER COVER	1
I142	INSERTO USCITA TUBO HOSE OUTLET PROTECTION	1
KC402	SUPPORTO ARROTOLATORE HOSEREEL SUPPORT	1
KC466	TAMBURO 510 510 HOSEREEL DRUM	1
KG205	SNODO GRASSO 600 BAR JOINT GREASE 600 BAR	1
KG206	SNODO ACQUA 200 BAR JOINT WATER 200 BAR	1
KG207	SNODO ACQUA 100 BAR JOINT WATER 100 BAR	1
KG212	SNODO ARIA-ACQUA 20 BAR JOINT AIR-WATER 20 BAR	1
KG224	SNODO ACQUA 400 BAR JOINT WATER 400 BAR	1
KG239	CARTER-MOLLA COVER SPRING-GROUP	1
P051	BOCCOLA LATO CREMAGLIERA BUSH	1
P052	BOCCOLA LATO MOLLA BUSH	1

ELENCO GUARNIZIONI SNODI

JOINTS GASKETS LIST

CODICE CODE	DESCRIZIONE DESCRIPTION	Q.TÀ QTY
H160	O-RING 2093 O-RING 2093	1
H183	GUARNIZIONE GASKET	1
H242	GUARNIZIONE M4 1810-PUR95 GASKET	1
H267	GUARNIZIONE VITON 90SH GASKET	1
H288	RONDELLA IN PTFE PTFE WASHER	1
H302	RONDELLA IN PTFE PTFE WASHER	1
H310	GUARNIZIONE OR 112 VITON GASKET	1
H367	GUARNIZIONE GASKET	1
H368	RONDELLA IN PTFE PTFE WASHER	1
H370	GUARNIZIONE OR 2062 VITON GASKET	1
H371	GUARNIZIONE OR 2037 VITON GASKET	1
H394	RONDELLA IN PTFE PTFE WASHER	1
H395	RONDELLA IN PTFE PTFE WASHER	1



Art. 8542.700 Mod. 542 BIN



VISTA ESPLOSA - EXPLODED VIEW

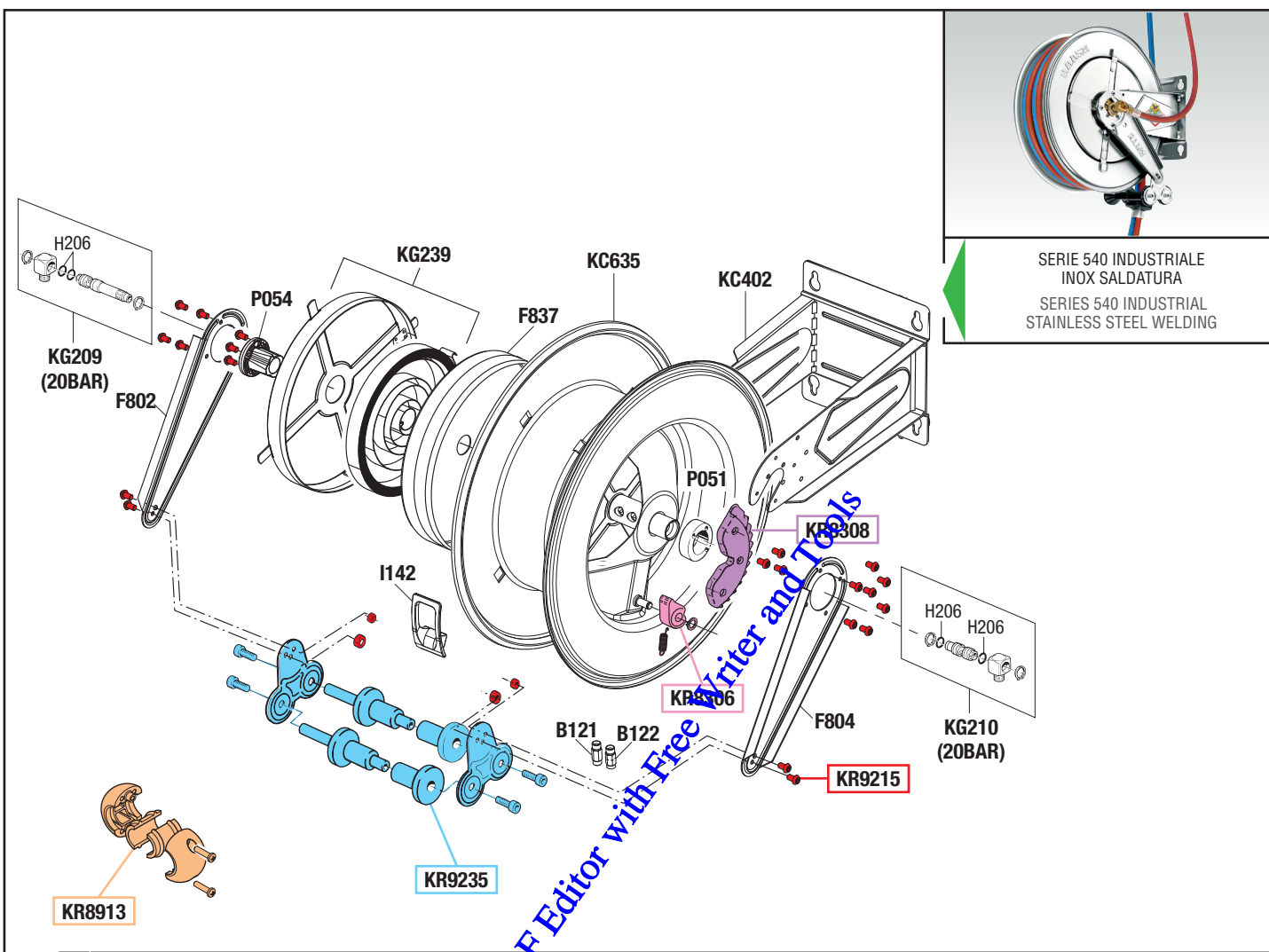

tutti i diritti riservati - all rights reserved

GUIDA RICAMBI - SPARE PARTS GUIDE

KIT RICAMBI
OGNI KIT SOTTO RIPORTATO COMPRENDE I RICAMBI EVIDENZIATI CON LO STESSO COLORE E LE RELATIVE GUARNIZIONI. QUESTI RICAMBI NON SONO FORNIBILI SEPARATAMENTE TRANNE QUELLI CODIFICATI.

SPARE PARTS KITS
EACH KIT SHOWN WITH THE SAME COLOR INCLUDES ALSO THE GASKETS. THE SPARE PARTS INCLUDED IN THE KIT CAN'T BE SUPPLIED SEPARATELY EXCEPT THOSE SHOWN WITH A PROPER CODE.

CODICE CODE	DESCRIZIONE DESCRIPTION	Q.TÀ QTY
KR8306	DENTE D'ARRESTO DETENT	1
KR8308	KIT CREMAGLIERA RACK KIT	1
KR8913	TAMPONE FERMATUBO HOSE STOP	1
KR9215	SET VITI ARROTOLATORE SET OF SCREWS FOR HOSE REEL	1
KR9235	KIT PORTA RULLI ARROTOLATORE ROLLERS HOLDING KIT FOR HOSE REEL	1

ELENCO RICAMBI FORNIBILI SINGOLARMENTE
LIST OF SPARE PARTS WHICH CAN BE SUPPLIED SEPARATELY

CODICE CODE	DESCRIZIONE DESCRIPTION	Q.TÀ QTY
B121	NIPPES SINISTRO LEFT ADAPTOR	1
B122	NIPPES DESTRO RIGHT ADAPTOR	1
F802	BRACCIO ORIENTABILE SWINGING ARM	1
F804	BRACCIO ORIENTABILE SWINGING ARM	1
F837	CARTER COVER	1
I142	INSERTO FORO USCITA TUBO HOSE OUTLET PROTECTION	1
KC402	SUPPORTO ARROTOLATORE HOSE REEL SUPPORT	1
KC635	TAMBURO DRUM	1
KG209	SNODO SINISTRO 20 BAR LEFT JOINT 20 BAR	1
KG210	SNODO DESTRO 20 BAR RIGHT JOINT 20 BAR	1
KG239	CARTER-MOLLA COVER SPRING-GROUP	1
P051	BOCCOLA LATO CREMAGLIERA BUSH	1
P054	BOCCOLA LATO MOLLA BUSH	1

ELENCO GUARNIZIONI SNODI
JOINTS GASKETS LIST

CODICE CODE	DESCRIZIONE DESCRIPTION	Q.TÀ QTY
H206	O-RING 3043 "VITON" O-RING 3043 "VITON"	4



Art. 8542.800 Mod. 542 GAS



VISTA ESPLOSA - EXPLODED VIEW

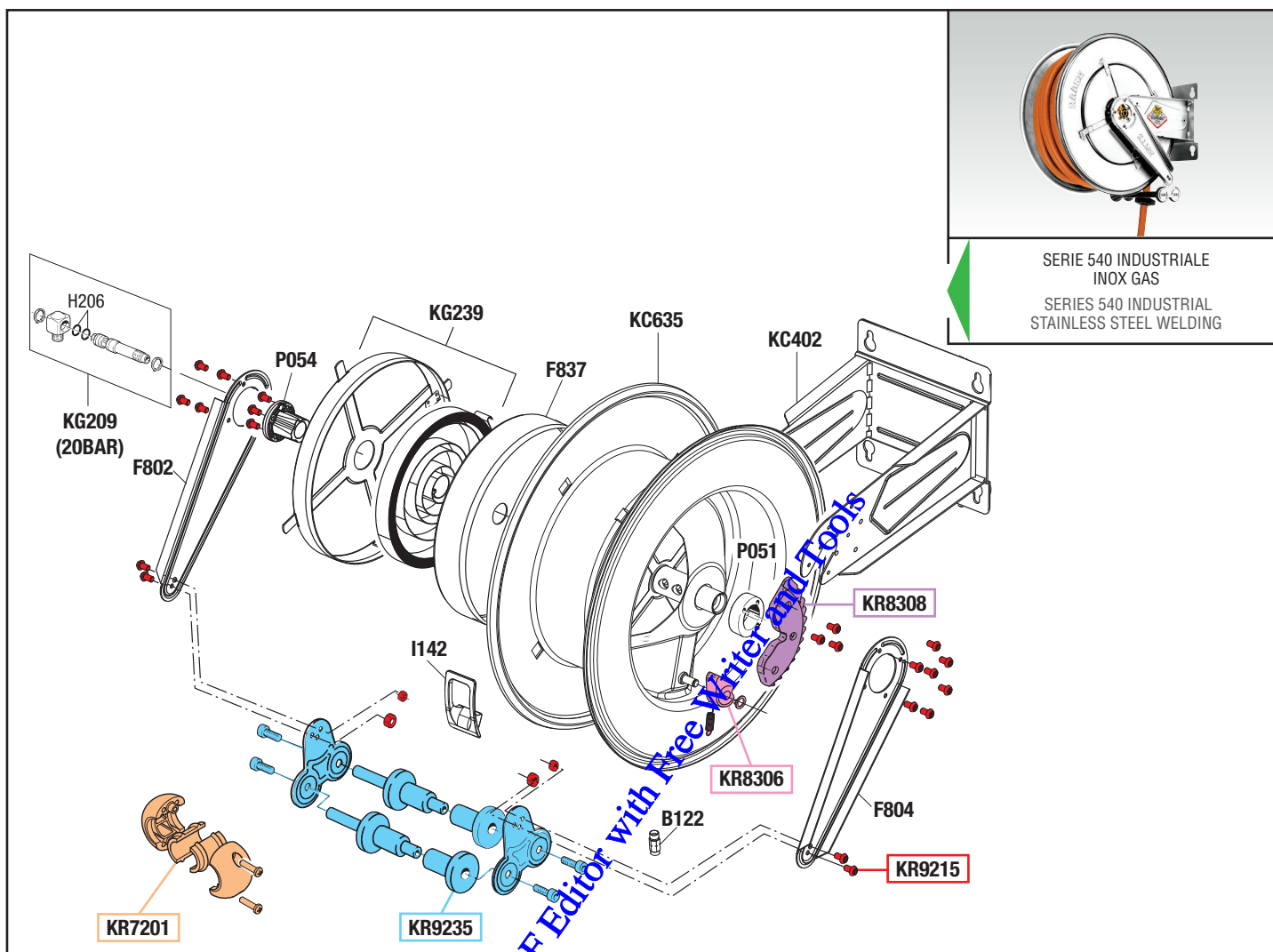

tutti i diritti riservati - all rights reserved

GUIDA RICAMBI - SPARE PARTS GUIDE

KIT RICAMBI

OGNI KIT SOTTO RIPORTATO COMPRENDE I RICAMBI EVIDENZIATI CON LO STESSO COLORE E LE RELATIVE GUARNIZIONI. QUESTI RICAMBI NON SONO FORNIBILI SEPARATAMENTE TRANNE QUELLI CODIFICATI.

SPARE PARTS KITS

EACH KIT SHOWN WITH THE SAME COLOR INCLUDES ALSO THE GASKETS. THE SPARE PARTS INCLUDED IN THE KIT CAN'T BE SUPPLIED SEPARATELY EXCEPT THOSE SHOWN WITH A PROPER CODE.

CODICE CODE	DESCRIZIONE DESCRIPTION	Q.TÀ QTY
KR7201	TAMPONE FERMATUBO HOSE STOP	1
KR8306	DENTE D'ARRESTO DETENT	1
KR8308	KIT CREMAGLIERA RACK KIT	1
KR9215	SET VITI ARROTOLATORE SET OF SCREWS FOR HOSEREEL	1
KR9235	KIT PORTA RULLI ARROTOLATORE ROLLERS HOLDING KIT FOR HOSEREEL	1

ELENCO RICAMBI FORNIBILI SINGOLARMENTE

LIST OF SPARE PARTS WHICH CAN BE SUPPLIED SEPARATELY

CODICE CODE	DESCRIZIONE DESCRIPTION	Q.TÀ QTY
B122	NIPPES DESTRO RIGHT ADAPTOR	1
F802	BRACCIO ORIENTABILE SWINGING ARM	1
F804	BRACCIO ORIENTABILE SWINGING ARM	1
F837	CARTER COVER	1
I142	INSERTO FORO USCITA TUBO HOSE OUTLET PROTECTION	1
KC402	SUPPORTO ARROTOLATORE HOSEREEL SUPPORT	1
KC635	TAMBURO DRUM	1
KG209	SNODO SINISTRO 20 BAR LEFT JOINT 20 BAR	1
KG239	CARTER-MOLLA COVER SPRING-GROUP	1
P051	BOCCOLA LATO CREMAGLIERA BUSH	1
P054	BOCCOLA LATO MOLLA BUSH	1

ELENCO GUARNIZIONI SNODI

JOINTS GASKETS LIST

CODICE CODE	DESCRIZIONE DESCRIPTION	Q.TÀ QTY
H206	O-RING 3043 "VITON" O-RING 3043 "VITON"	2



Art. 8545.200 Mod. 546-10m-1"-20 bar



VISTA ESPLOSA - EXPLODED VIEW

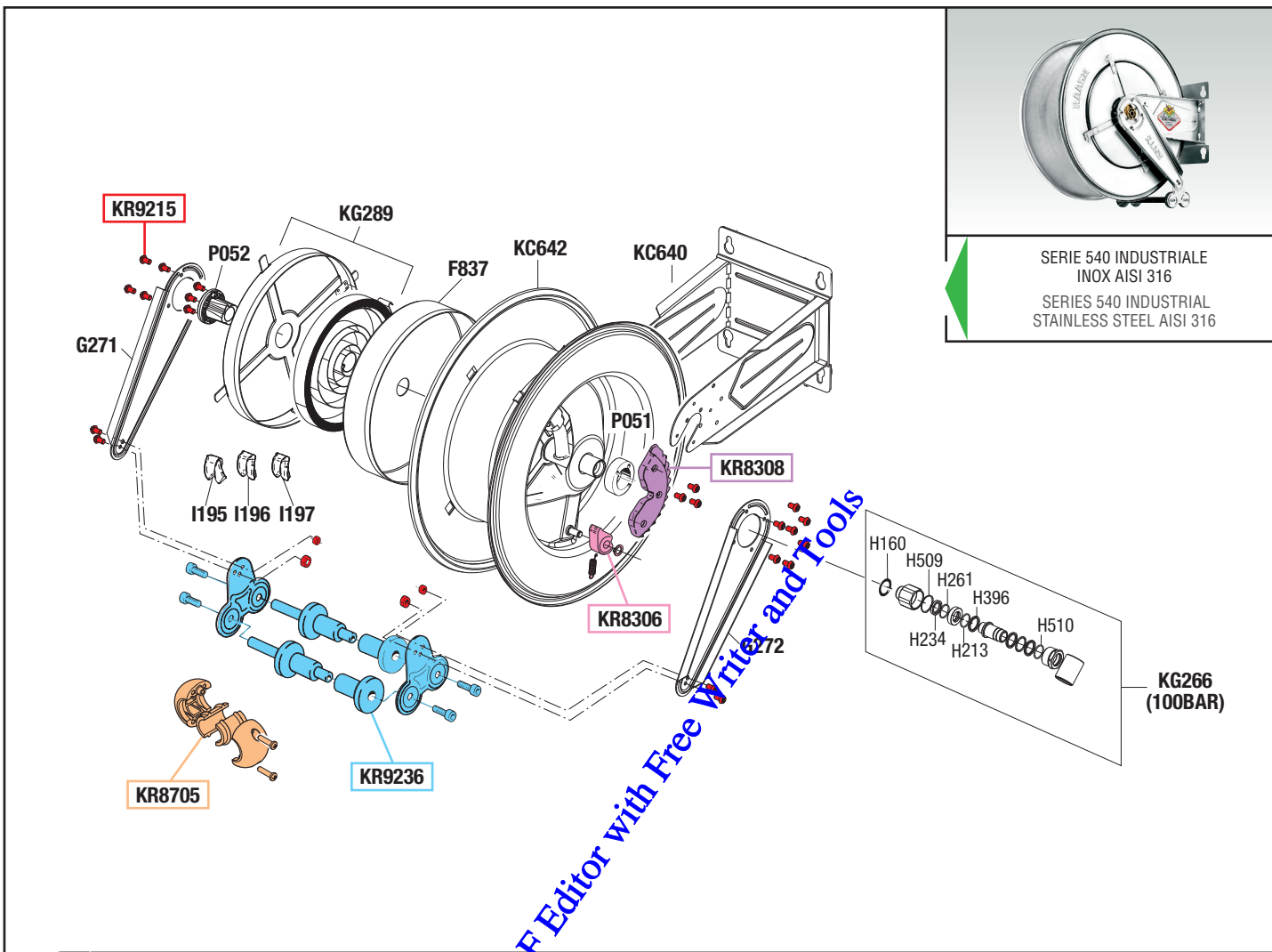

GUIDA RICAMBI - SPARE PARTS GUIDE

KIT RICAMBI
OGNI KIT SOTTO RIPORTATO COMPRENDE I RICAMBI EVIDENZIATI CON LO STESSO COLORE E LE RELATIVE GUARNIZIONI. QUESTI RICAMBI NON SONO FORNIBILI SEPARATAMENTE TRANNE QUELLI CODIFICATI.

SPARE PARTS KITS
EACH KIT SHOWN WITH THE SAME COLOR INCLUDES ALSO THE GASKETS. THE SPARE PARTS INCLUDED IN THE KIT CAN'T BE SUPPLIED SEPARATELY EXCEPT THOSE SHOWN WITH A PROPER CODE.

CODICE CODE	DESCRIZIONE DESCRIPTION	Q.TÀ QTY
KR8306	DENTE D'ARRESTO DETENT	1
KR8308	KIT CREMAGLIERA RACK KIT	1
KR8705	TAMPONE FERMATUBO HOSE STOP	1
KR9215	SET VITI ARROTOLATORE SET OF SCREWS FOR HOSE REEL	1
KR9236	KIT PORTA RULLI ARROTOLATORE ROLLERS HOLDING KIT FOR HOSE REEL	1

ELENCO RICAMBI FORNIBILI SINGOLARMENTE
LIST OF SPARE PARTS WHICH CAN BE SUPPLIED SEPARATELY

CODICE CODE	DESCRIZIONE DESCRIPTION	Q.TÀ QTY
F837	CARTER COVER	1
G271	BRACCIO ORIENTABILE SWINGING ARM	1
G272	BRACCIO ORIENTABILE SWINGING ARM	1
I195	INSERTO USCITA TUBO Ø34-38 HOSE OUTLET PROTECTION	1
I196	INSERTO USCITA TUBO Ø30-34 HOSE OUTLET PROTECTION	1
I197	INSERTO USCITA TUBO Ø26-30 HOSE OUTLET PROTECTION	1
KC640	SUPPORTO ARROTOLATORE HOSE REEL SUPPORT	1
KC642	TAMBURO 510 510 HOSE REEL DRUM	1
KG266	SNODO ACQUA 100 BAR JOINT WATER 100 BAR	1
KG289	CARTER-MOLLA COVER SPRING-GROUP	1
P051	BOCCOLA LATO CREMAGLIERA BUSH	1
P052	BOCCOLA LATO MOLLA BUSH	1

ELENCO GUARNIZIONI SNODI
JOINTS GASKETS LIST

CODICE CODE	DESCRIZIONE DESCRIPTION	Q.TÀ QTY
H160	O-RING 2093 O-RING 2093	1
H213	GUARNIZIONE OR 2087 VITON GASKET	1
H234	GUARNIZIONE DI 087 VITON GASKET	1
H261	RONDELLA IN PTFE PTFE WASHER	1
H396	RONDELLA IN PTFE PTFE WASHER	1
H509	GUARNIZIONE OR 2131 VITON GASKET	1
H510	GUARNIZIONE OR 2106 VITON GASKET	1

tutti i diritti riservati - all rights reserved



Art. 8549.0100 Mod. 540-ASP-25 - Art. 8549.0110 Mod. 540-ASP-30

VISTA ESPLOSA - EXPLODED VIEW

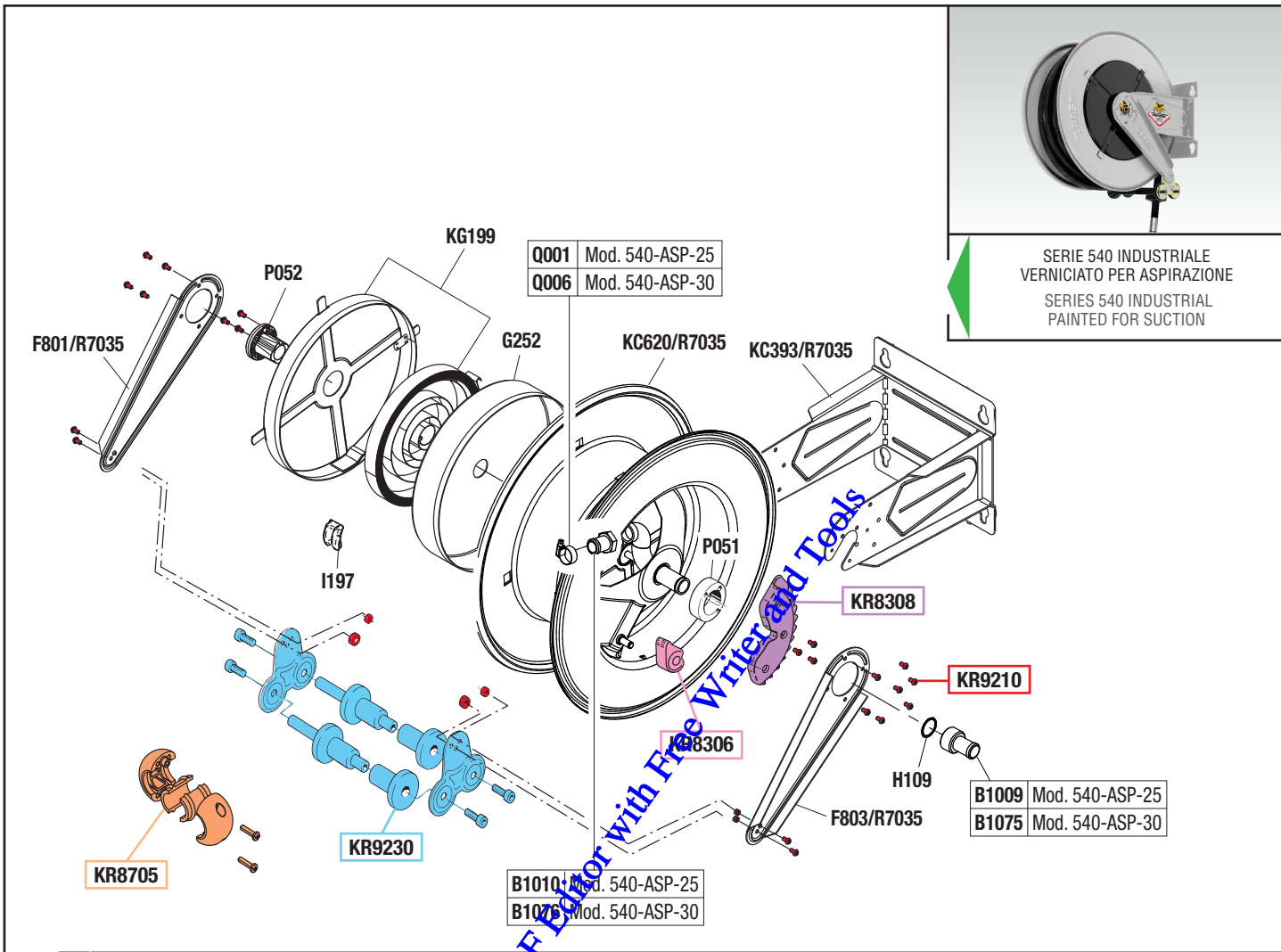

GUIDA RICAMBI - SPARE PARTS GUIDE

KIT RICAMBI
OGNI KIT SOTTO RIPORTATO COMPRENDE I RICAMBI EVIDENZIATI CON LO STESSO COLORE E LE RELATIVE GUARNIZIONI. QUESTI RICAMBI NON SONO FORNIBILI SEPARATAMENTE TRANNE QUELLI CODIFICATI.

SPARE PARTS KITS
EACH KIT SHOWN WITH THE SAME COLOR INCLUDES ALSO THE GASKETS. THE SPARE PARTS INCLUDED IN THE KIT CAN'T BE SUPPLIED SEPARATELY EXCEPT THOSE SHOWN WITH A PROPER CODE.

CODICE CODE	DESCRIZIONE DESCRIPTION	Q.TÀ QTY
KR8705	TAMPONE FERMATUBO HOSE STOP	1
KR8306	DENTE D'ARRESTO DETENT	1
KR8308	KIT CREMAGLIERA RACK KIT	1
KR9210	SET VITI ARROTOLATORE SET OF SCREWS FOR HOSE REEL	1
KR9230	KIT PORTA RULLI ARROTOLATORE ROLLERS HOLDING KIT FOR HOSE REEL	1

ELENCO RICAMBI FORNIBILI SINGOLARMENTE
LIST OF SPARE PARTS WHICH CAN BE SUPPLIED SEPARATELY

CODICE CODE	DESCRIZIONE DESCRIPTION	Q.TÀ QTY
B1009	PORTA TUBO FEMMINA (Art. 8549.0100) FEMALE HOSE HOLDER (Art. 8549.0100)	1
B1010	PORTA TUBO MASCHIO (Art. 8549.0100) MALE HOSE HOLDER (Art. 8549.0100)	1
B1075	PORTA TUBO FEMMINA (Art. 8549.0110) FEMALE HOSE HOLDER (Art. 8549.0110)	1
B1076	PORTA TUBO MASCHIO (Art. 8549.0110) MALE HOSE HOLDER (Art. 8549.0110)	1
F801/R7035	BRACCIO ORIENTABILE SWINGING ARM	1
F803/R7035	BRACCIO ORIENTABILE SWINGING ARM	1
G252	CARTER COVER	1
I197	INSERTO FORO USCITA TUBO HOSE OUTLET PROTECTION	1
KC393/R7035	SUPPORTO ARROTOLATORE HOSE REEL SUPPORT	1
KC620/R7035	TAMBURIO DRUM	1
KG199	CARTER-MOLLA COVER SPRING-GROUP	1
P051	BOCCOLA LATO CREMAGLIERA BUSH	1
P052	BOCCOLA LATO MOLLA BUSH	1
Q001	FASCETTA STRINGITUBO (Art. 8549.0100) HOSE CLAMP (Art. 8549.0100)	1
Q006	FASCETTA STRINGITUBO (Art. 8549.0110) HOSE CLAMP (Art. 8549.0110)	1

ELENCO GUARNIZIONI SNODI
JOINTS GASKETS LIST

CODICE CODE	DESCRIZIONE DESCRIPTION	Q.TÀ QTY
H109	O-RING 3131 O-RING 3131	1

tutti i diritti riservati - all rights reserved



Art. 8550.100 Mod. 550-1"-20 bar - Art. 8550.200 Mod. 550-1"-100 bar
 Art. 8550.400 Mod. 550-1"-150 bar



VISTA ESPLOSA - EXPLODED VIEW

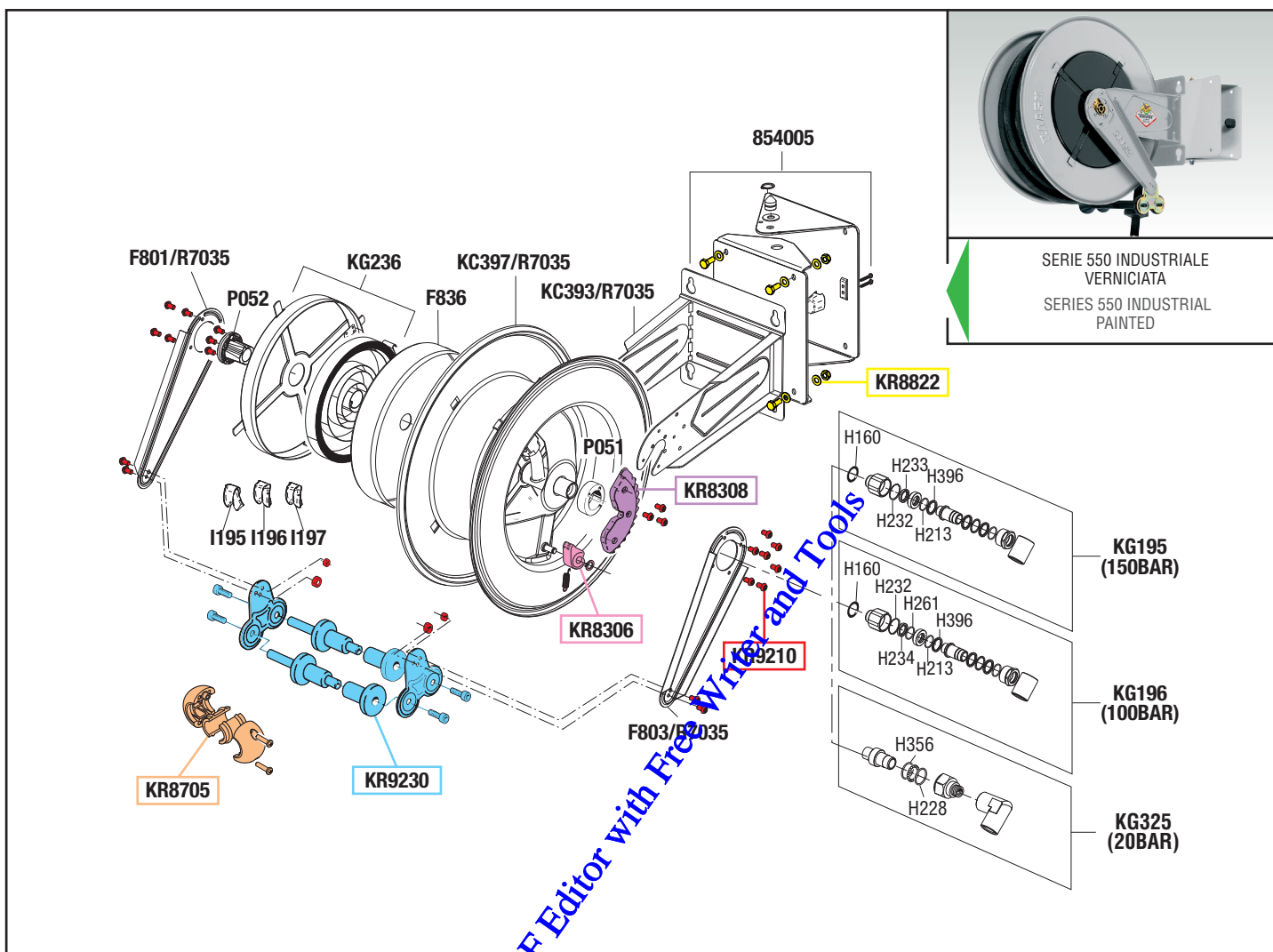

tutti i diritti riservati - all rights reserved

GUIDA RICAMBI - SPARE PARTS GUIDE

KIT RICAMBI
 OGNI KIT SOTTO RIPORTATO COMPRENDE I RICAMBI EVIDENZIATI CON LO STESSO COLORE E LE RELATIVE GUARNIZIONI. QUESTI RICAMBI NON SONO FORNIBILI SEPARATAMENTE TRANNE QUELLI CODIFICATI.

SPARE PARTS KITS
 EACH KIT SHOWN WITH THE SAME COLOR INCLUDES ALSO THE GASKETS. THE SPARE PARTS INCLUDED IN THE KIT CAN'T BE SUPPLIED SEPARATELY EXCEPT THOSE SHOWN WITH A PROPER CODE.

CODICE CODE	DESCRIZIONE DESCRIPTION	Q.TÀ QTY
KR8306	DENTE D'ARRESTO DETENT	1
KR8308	KIT CREMAGLIERA RACK KIT	1
KR8705	TAMPONE FERMATUBO HOSE STOP	1
KR8822	SET VITI SET OF SCREWS	1
KR9210	SET VITI ARROTOLATORE SET OF SCREWS FOR HOSEREEL	1
KR9230	KIT PORTA RULLI ARROTOLATORE ROLLERS HOLDING KIT FOR HOSEREEL	1

ELENCO RICAMBI FORNIBILI SINGOLARMENTE
 LIST OF SPARE PARTS WHICH CAN BE SUPPLIED SEPARATELY

CODICE CODE	DESCRIZIONE DESCRIPTION	Q.TÀ QTY
854005	STAFFA ORIENTABILE PIVOTING BRACKET	1
F801/R7035	BRACCIO ORIENTABILE SWINGING ARM	1
F803/R7035	BRACCIO ORIENTABILE SWINGING ARM	1
F836	CARTER COVER	1
I195	INSERTO USCITA TUBO Ø34-38 HOSE OUTLET PROTECTION	1
I196	INSERTO USCITA TUBO Ø30-34 HOSE OUTLET PROTECTION	1
I197	INSERTO USCITA TUBO Ø26-30 HOSE OUTLET PROTECTION	1
KC393/R7035	SUPPORTO ARROTOLATORE HOSEREEL SUPPORT	1
KC397/R7035	TAMBURO 510 510 HOSEREEL DRUM	1
KG236	CARTER-MOLLA COVER-SPRING GROUP	1
KG195	SNODO OLIO 150 BAR JOINT OIL 150 BAR	1
KG196	SNODO ACQUA 100 BAR JOINT WATER 100 BAR	1
KG214	SNODO ARIA-ACQUA 20 BAR JOINT AIR-WATER 20 BAR	1
P051	BOCCOLA LATO CREMAGLIERA BUSH	1
P052	BOCCOLA LATO MOLLA BUSH	1

ELENCO GUARNIZIONI SNODI
 JOINTS GASKETS LIST

CODICE CODE	DESCRIZIONE DESCRIPTION	Q.TÀ QTY
H160	O-RING 2093 O-RING 2093	1
H213	GUARNIZIONE OR 2087 VITON GASKET	1
H228	O-RING 4112 VITON O-RING 4112 VITON	1
H232	GUARNIZIONE GASKET	1
H233	GUARNIZIONE GASKET	1
H234	O-RING 2131 DI 087 VITON O-RING 2131 DI 087 VITON	1
H261	RONDELLA IN PTFE PTFE WASHER	1
H356	O-RING 3106 VITON O-RING 3106 VITON	1
H396	RONDELLA IN PTFE PTFE WASHER	1



Art. 8550.105 Mod. 550-1/2"-20 bar - Art. 8550.205 Mod. 550-1/2"-100 bar
 Art. 8550.300 Mod. 550-200 bar - Art. 8550.350 Mod. 550-400 bar
 Art. 8550.405 Mod. 550-1/2"-150 bar - Art. 8550.500 Mod. 550-600 bar



VISTA ESPLOSA - EXPLODED VIEW

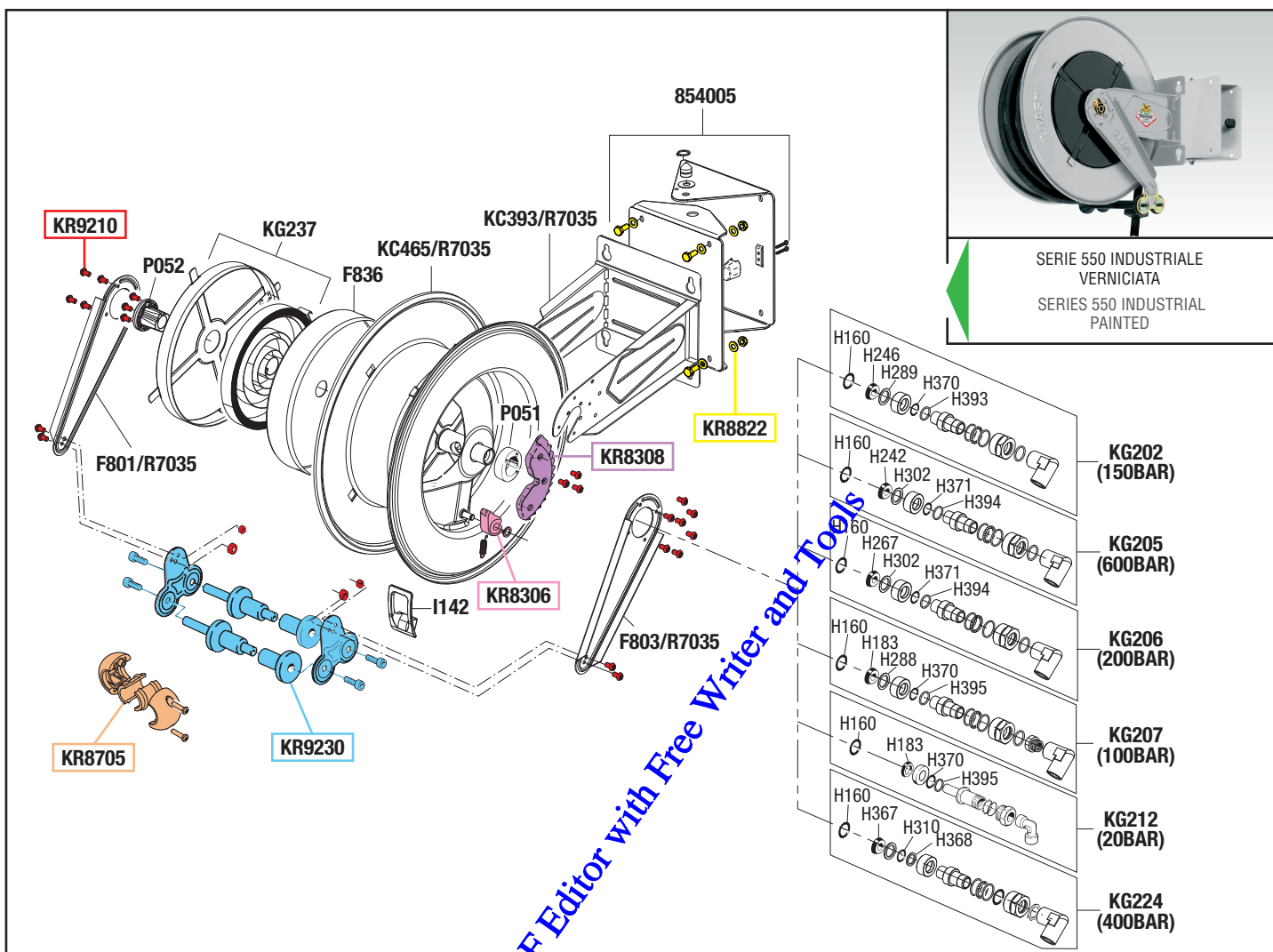

SERIE 550 INDUSTRIALE
 VERNICIATA
 SERIES 550 INDUSTRIAL
 PAINTED

GUIDA RICAMBI - SPARE PARTS GUIDE

KIT RICAMBI
 OGNI KIT SOTTO RIPORTATO COMPRENDE I RICAMBI EVIDENZIATI CON LO STESSO COLORE E LE RELATIVE GUARNIZIONI. QUESTI RICAMBI NON SONO FORNIBILI SEPARATAMENTE TRANNE QUELLI CODIFICATI.

SPARE PARTS KITS
 EACH KIT SHOWN WITH THE SAME COLOR INCLUDES ALSO THE GASKETS. THE SPARE PARTS INCLUDED IN THE KIT CAN'T BE SUPPLIED SEPARATELY EXCEPT THOSE SHOWN WITH A PROPER CODE.

CODICE CODE	DESCRIZIONE DESCRIPTION	Q.TÀ QTY
KR8306	DENTE D'ARRESTO DETENT	1
KR8308	KIT CREMAGLIERA RACK KIT	1
KR8705	TAMPONE FERMATUBO HOSE STOP	1
KR8822	SET VITI SET OF SCREWS	1
KR9210	SET VITI ARROTATORE SET OF SCREWS FOR HOSEREEL	1
KR9230	KIT PORTA RULLI ARROTATORE ROLLERS HOLDING KIT FOR HOSEREEL	1

ELENCO RICAMBI FORNIBILI SINGOLARMENTE
 LIST OF SPARE PARTS WHICH CAN BE SUPPLIED SEPARATELY

CODICE CODE	DESCRIZIONE DESCRIPTION	Q.TÀ QTY
854005	STAFFA ORIENTABILE PIVOTING BRACKET	1
F801/R7035	BRACCIO ORIENTABILE SWINGING ARM	1
F803/R7035	BRACCIO ORIENTABILE SWINGING ARM	1
F836	CARTER COVER	1
I142	INSERTO USCITA TUBO HOSE OUTLET PROTECTION	1
KC393/R7035	SUPPORTO ARROTATORE HOSEREEL SUPPORT	1
KC465/R7035	TAMBURO 510 510 HOSEREEL DRUM	1
KG202	SNODO OLIO 150 BAR JOINT OIL 150 BAR	1
KG205	SNODO GRASSO 600 BAR JOINT GREASE 600 BAR	1
KG206	SNODO ACQUA 200 BAR JOINT WATER 200 BAR	1
KG207	SNODO ACQUA 100 BAR JOINT WATER 100 BAR	1
KG212	SNODO ARIA-ACQUA 20 BAR JOINT AIR-WATER 20 BAR	1
KG224	SNODO ACQUA 400 BAR JOINT WATER 400 BAR	1
KG237	CARTER-MOLLA COVER SPRING-GROUP	1
P051	BOCCOLA LATO CREMAGLIERA BUSH	1
P052	BOCCOLA LATO MOLLA BUSH	1

ELENCO GUARNIZIONI SNODI
 JOINTS GASKETS LIST

CODICE CODE	DESCRIZIONE DESCRIPTION	Q.TÀ QTY
H160	O-RING 2093 O-RING 2093	1
H183	GUARNIZIONE GASKET	1
H242	GUARNIZIONE M4 1810-PUR95 GASKET	1
H246	GUARNIZ. MAD2060/2-PUR95 GASKET	1
H267	GUARNIZIONE VITON 90SH GASKET	1
H288	RONDELLA IN PTFE PTFE WASHER	1
H289	RONDELLA IN PTFE PTFE WASHER	1
H302	RONDELLA IN PTFE PTFE WASHER	1
H310	GUARNIZIONE OR 112 VITON GASKET	1
H367	GUARNIZIONE GASKET	1
H368	RONDELLA IN PTFE PTFE WASHER	1
H370	GUARNIZIONE OR 2062 VITON GASKET	1
H371	GUARNIZIONE OR 2037 VITON GASKET	1
H393	RONDELLA IN PTFE PTFE WASHER	1
H394	RONDELLA IN PTFE PTFE WASHER	1
H395	RONDELLA IN PTFE PTFE WASHER	1

tutti i diritti riservati - all rights reserved



Art. 8550.700 Mod. 550 BIN



VISTA ESPLOSA - EXPLODED VIEW

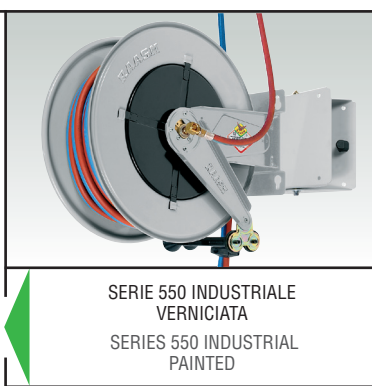
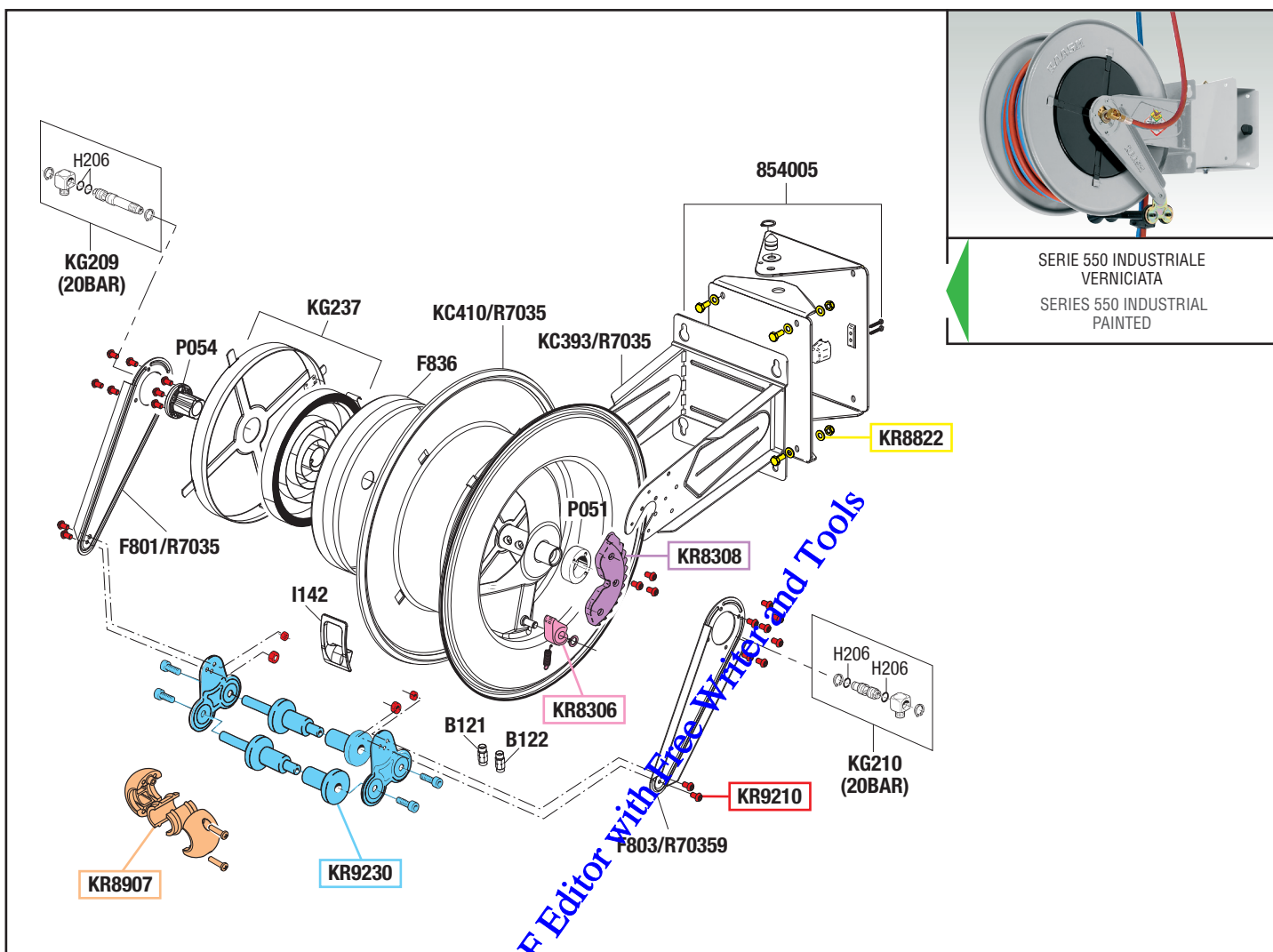

GUIDA RICAMBI - SPARE PARTS GUIDE

KIT RICAMBI
OGNI KIT SOTTO RIPORTATO COMPRENDE I RICAMBI EVIDENZIATI CON LO STESSO COLORE E LE RELATIVE GUARNIZIONI. QUESTI RICAMBI NON SONO FORNIBILI SEPARATAMENTE TRANNE QUELLI CODIFICATI.

SPARE PARTS KITS
EACH KIT SHOWN WITH THE SAME COLOR INCLUDES ALSO THE GASKETS. THE SPARE PARTS INCLUDED IN THE KIT CAN'T BE SUPPLIED SEPARATELY EXCEPT THOSE SHOWN WITH A PROPER CODE.

CODICE CODE	DESCRIZIONE DESCRIPTION	Q.TÀ QTY
KR8306	DENTE D'ARRESTO DETENT	1
KR8308	KIT CREMAGLIERA RACK KIT	1
KR8822	SET VITI SET OF SCREWS	1
KR8907	TAMPONE FERMATUBO HOSE STOP	1
KR9210	SET VITI ARROTATORE SET OF SCREWS FOR HOSEREEL	1
KR9230	KIT PORTA RULLI ARROTATORE ROLLERS HOLDING KIT FOR HOSEREEL	1

ELENCO RICAMBI FORNIBILI SINGOLARMENTE
LIST OF SPARE PARTS WHICH CAN BE SUPPLIED SEPARATELY

CODICE CODE	DESCRIZIONE DESCRIPTION	Q.TÀ QTY
854005	STAFFA ORIENTABILE PIVOTING BRACKET	1
B121	NIPPLES SINISTRO LEFT ADAPTOR	1
B122	NIPPLES DESTRO RIGHT ADAPTOR	1
F801/R7035	BRACCIO ORIENTABILE SWINGING ARM	1
F803/R7035	BRACCIO ORIENTABILE SWINGING ARM	1
I142	INSERTO USCITA TUBO HOSE OUTLET PROTECTION	1
KC393/R7035	SUPPORTO ARROTATORE HOSEREEL SUPPORT	1
KC410/R7035	TAMBURO 510 510 HOSEREEL DRUM	1
KG237	CARTER-MOLLA COVER SPRING-GROUP	1
KG209	SNODO SINISTRO 20 BAR LEFT JOINT 20 BAR	1
KG210	SNODO DESTRO 20 BAR RIGHT JOINT 20 BAR	1
P051	BOCCOLA LATO CREMAGLIERA BUSH	1
P054	BOCCOLA LATO MOLLA BUSH	1

ELENCO GUARNIZIONI SNODI
JOINTS GASKETS LIST

CODICE CODE	DESCRIZIONE DESCRIPTION	Q.TÀ QTY
H206	O-RING 3043 VITON O-RING 3043 VITON	4

tutti i diritti riservati - all rights reserved



Art. 8550.800 Mod. 550 GAS



VISTA ESPLOSA - EXPLODED VIEW

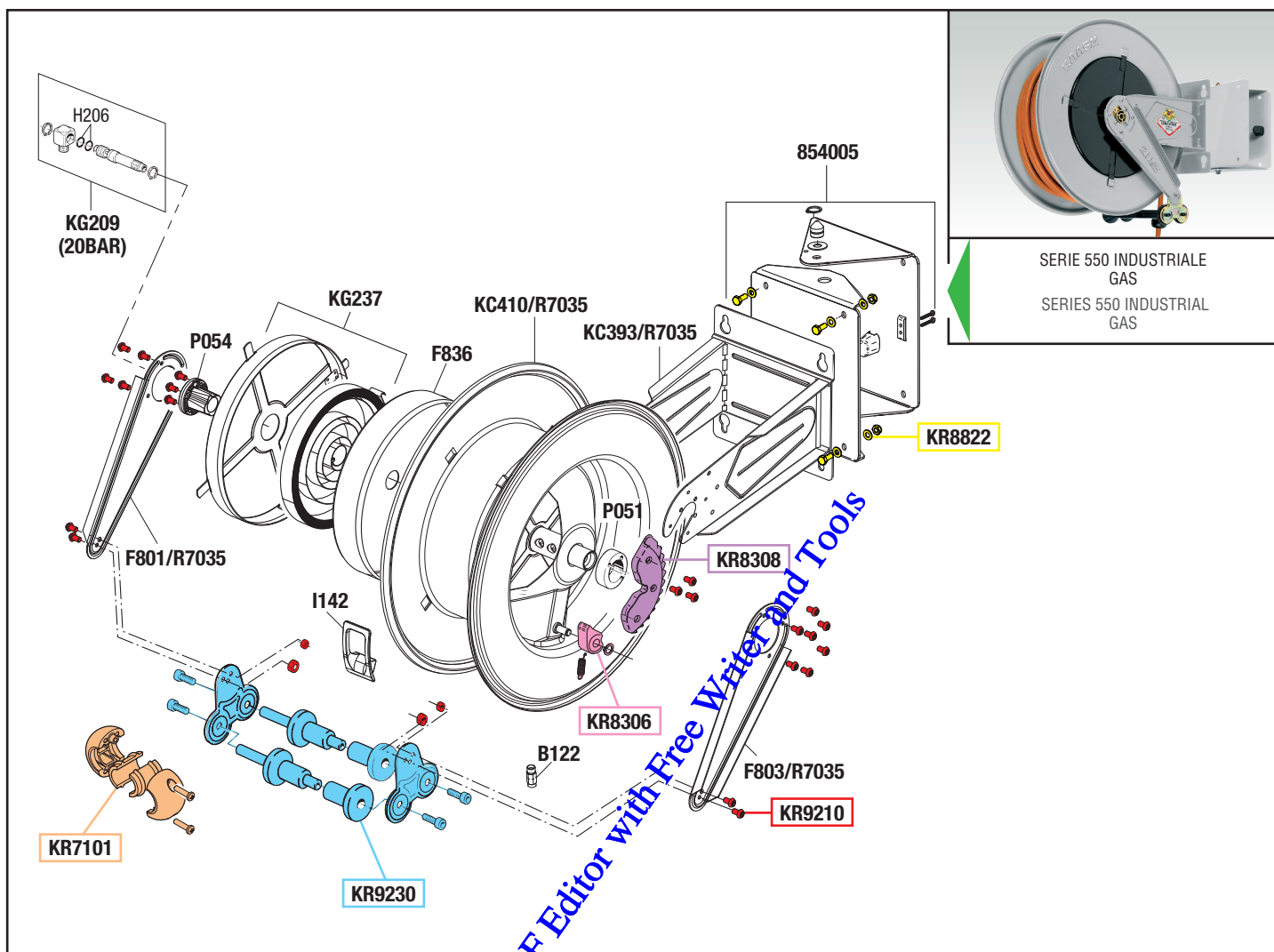

SERIE 550 INDUSTRIALE GAS
SERIES 550 INDUSTRIAL GAS

GUIDA RICAMBI - SPARE PARTS GUIDE

KIT RICAMBI
OGNI KIT SOTTO RIPORTATO COMPRENDE I RICAMBI EVIDENZIATI CON LO STESSO COLORE E LE RELATIVE GUARNIZIONI. QUESTI RICAMBI NON SONO FORNIBILI SEPARATAMENTE TRANNE QUELLI CODIFICATI.

SPARE PARTS KITS

EACH KIT SHOWN WITH THE SAME COLOR INCLUDES ALSO THE GASKETS. THE SPARE PARTS INCLUDED IN THE KIT CAN'T BE SUPPLIED SEPARATELY EXCEPT THOSE SHOWN WITH A PROPER CODE.

CODICE CODE	DESCRIZIONE DESCRIPTION	Q.TÀ QTY
KR7101	TAMPONE FERMATUBO HOSE STOP	1
KR8306	DENTE D'ARRESTO DETENT	1
KR8308	KIT CREMAGLIERA RACK KIT	1
KR8822	SET VITI SET OF SCREWS	1
KR9210	SET VITI ARROTATORE SET OF SCREWS FOR HOSEREEL	1
KR9230	KIT PORTA RULLI ARROTATORE ROLLERS HOLDING KIT FOR HOSEREEL	1

ELENCO RICAMBI FORNIBILI SINGOLARMENTE
LIST OF SPARE PARTS WHICH CAN BE SUPPLIED SEPARATELY

CODICE CODE	DESCRIZIONE DESCRIPTION	Q.TÀ QTY
854005	STAFFA ORIENTABILE INOX STAINLESS STEEL PIVOTING BRACKET	1
B122	NIPPLES SINISTRO LEFT ADAPTOR	1
F801/R7035	BRACCIO ORIENTABILE SWINGING ARM	1
F803/R7035	BRACCIO ORIENTABILE SWINGING ARM	1
F836	CARTER COVER	1
I142	INSERTO FORO USCITA TUBO HOSE OUTLET PROTECTION	1
KC393/R7035	SUPPORTO ARROTATORE HOSEREEL SUPPORT	1
KC410/R7035	TAMBURO 510 510 HOSEREEL DRUM	1
KG209	SNODO SX 20 BAR HOSEREEL JOINT	1
KG237	CARTER-MOLLA COVER-SPRING GROUP	1
P051	BOCCOLA LATO CREMAGLIERA BUSH	1
P054	BOCCOLA LATO MOLLA BUSH	1

ELENCO GUARNIZIONI SNODI

JOINTS GASKETS LIST

CODICE CODE	DESCRIZIONE DESCRIPTION	Q.TÀ QTY
H206	O-RING 3043 VITON O-RING 3043 VITON	2

tutti i diritti riservati - all rights reserved



Art. 8552.100 Mod. 552-1"-20 bar - Art. 8554.200 Mod. 554-1"-100 bar



VISTA ESPLOSA - EXPLODED VIEW

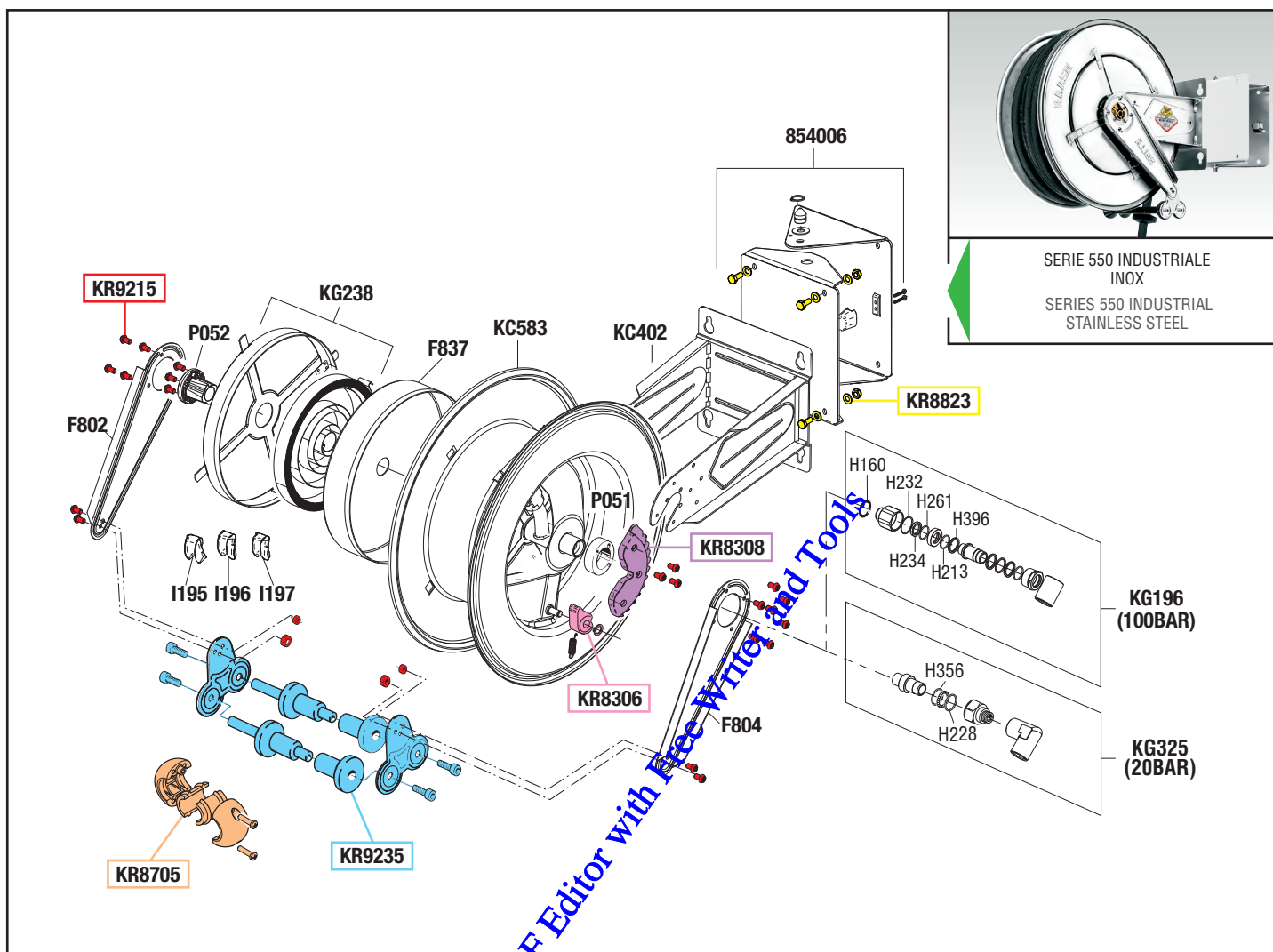

tutti i diritti riservati - all rights reserved

GUIDA RICAMBI - SPARE PARTS GUIDE

KIT RICAMBI

OGNI KIT SOTTO RIPORTATO COMPRENDE I RICAMBI EVIDENZIATI CON LO STESSO COLORE E LE RELATIVE GUARNIZIONI. QUESTI RICAMBI NON SONO FORNIBILI SEPARATAMENTE TRANNE QUELLI CODIFICATI.

SPARE PARTS KITS

EACH KIT SHOWN WITH THE SAME COLOR INCLUDES ALSO THE GASKETS. THE SPARE PARTS INCLUDED IN THE KIT CAN'T BE SUPPLIED SEPARATELY EXCEPT THOSE SHOWN WITH A PROPER CODE.

CODICE CODE	DESCRIZIONE DESCRIPTION	Q.TÀ QTY
KR8306	DENTE D'ARRESTO DETENT	1
KR8308	KIT CREMAGLIERA RACK KIT	1
KR8705	TAMPONE FERMATUBO HOSE STOP	1
KR8823	SET VITI SET OF SCREWS	1
KR9215	SET VITI ARROTATORE SET OF SCREWS FOR HOSEREEL	1
KR9235	KIT PORTA RULLI ARROTATORE ROLLERS HOLDING KIT FOR HOSEREEL	1

ELENCO RICAMBI FORNIBILI SINGOLARMENTE

LIST OF SPARE PARTS WHICH CAN BE SUPPLIED SEPARATELY

CODICE CODE	DESCRIZIONE DESCRIPTION	Q.TÀ QTY
854006	STAFFA ORIENTABILE INOX STAINLESS STEEL PIVOTING BRACKET	1
F802	BRACCIO ORIENTABILE SWINGING ARM	1
F804	BRACCIO ORIENTABILE SWINGING ARM	1
F837	CARTER COVER	1
I195	INSERTO USCITA TUBO Ø34-38 HOSE OUTLET PROTECTION	1
I196	INSERTO USCITA TUBO Ø30-34 HOSE OUTLET PROTECTION	1
I197	INSERTO USCITA TUBO Ø26-30 HOSE OUTLET PROTECTION	1
KC402	SUPPORTO ARROTATORE HOSEREEL SUPPORT	1
KC583	TAMBURO 510 510 HOSEREEL DRUM	1
KG196	SNODO ACQUA 100 BAR JOINT WATER 100 BAR	1
KG214	SNODO ARIA-ACQUA 20 BAR JOINT AIR-WATER 20 BAR	1
KG238	CARTER-MOLLA COVER SPRING-GROUP	1
P051	BOCCOLA LATO CREMAGLIERA BUSH	1
P052	BOCCOLA LATO MOLLA BUSH	1

ELENCO GUARNIZIONI SNODI

JOINTS GASKETS LIST

CODICE CODE	DESCRIZIONE DESCRIPTION	Q.TÀ QTY
H160	O-RING 2093 O-RING 2093	1
H213	GUARNIZIONE OR 2087 VITON GASKET	1
H228	O-RING 4112 VITON O-RING 4112 VITON	1
H232	GUARNIZIONE OR 2131 GASKET	1
H234	GUARNIZIONE DI 087 VITON GASKET	1
H261	RONDELLA IN PTFE PTFE WASHER	1
H356	O-RING 3106 VITON O-RING 3106 VITON	1
H396	RONDELLA IN PTFE PTFE WASHER	1



Art. 8552.105 Mod. 552-1/2"-20 bar - Art. 8552.500 Mod. 552-600 bar
 Art. 8554.205 Mod. 554-1/2"-100 bar - Art. 8554.300 Mod. 554-200 bar
 Art. 8554.350 Mod. 554-400 bar



VISTA ESPLOSA - EXPLODED VIEW

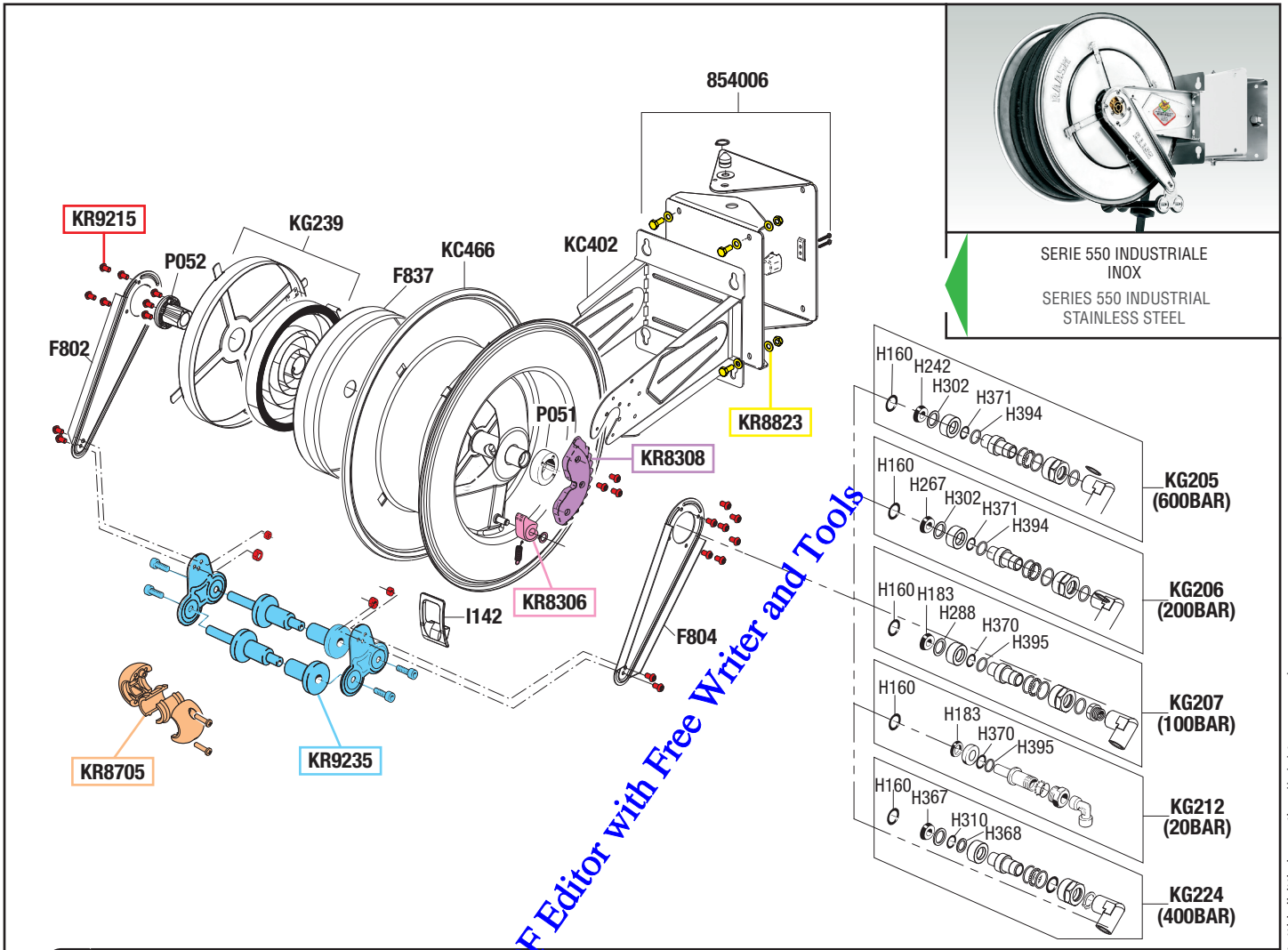

- H160 H242 H302 H371 H394
- H160 H267 H302 H371 H394 **KG205 (600BAR)**
- H160 H183 H288 H370 H395 **KG206 (200BAR)**
- H160 H183 H370 H395 **KG207 (100BAR)**
- H160 H367 H310 H368 **KG212 (20BAR)**
- H160 H367 H310 H368 **KG224 (400BAR)**

GUIDA RICAMBI - SPARE PARTS GUIDE

KIT RICAMBI
 OGNI KIT SOTTO RIPORTATO COMPRENDE I RICAMBI EVIDENZIATI CON LO STESSO COLORE E LE RELATIVE GUARNIZIONI. QUESTI RICAMBI NON SONO FORNIBILI SEPARATAMENTE TRANNE QUELLI CODIFICATI.

SPARE PARTS KITS
 EACH KIT SHOWN WITH THE SAME COLOR INCLUDES ALSO THE GASKETS. THE SPARE PARTS INCLUDED IN THE KIT CAN'T BE SUPPLIED SEPARATELY EXCEPT THOSE SHOWN WITH A PROPER CODE.

CODICE CODE	DESCRIZIONE DESCRIPTION	Q.TÀ QTY
KR8306	DENTE D'ARRESTO DETENT	1
KR8308	KIT CREMAGLIERA RACK KIT	1
KR8705	TAMPONE FERMATUBO HOSE STOP	1
KR8823	SET VITI SET OF SCREWS	1
KR9215	SET VITI ARROTATORE SET OF SCREWS FOR HOSEREEL	1
KR9235	KIT PORTA RULLI ARROTATORE ROLLERS HOLDING KIT FOR HOSEREEL	1

ELENCO RICAMBI FORNIBILI SINGOLARMENTE
 LIST OF SPARE PARTS WHICH CAN BE SUPPLIED SEPARATELY

CODICE CODE	DESCRIZIONE DESCRIPTION	Q.TÀ QTY
854006	STAFFA ORIENTABILE PIVOTING BRACKET	
F802	BRACCIO ORIENTABILE SWINGING ARM	1
F804	BRACCIO ORIENTABILE SWINGING ARM	1
F837	CARTER COVER	1
I142	INSERTO USCITA TUBO HOSE OUTLET PROTECTION	1
KC402	SUPPORTO ARROTATORE HOSEREEL SUPPORT	1
KC466	TAMBURO 510 510 HOSEREEL DRUM	1
KG205	SNODO GRASSO 600 BAR JOINT GREASE 600 BAR	1
KG206	SNODO ACQUA 200 BAR JOINT WATER 200 BAR	1
KG207	SNODO ACQUA 100 BAR JOINT WATER 100 BAR	1
KG212	SNODO ARIA-ACQUA 20 BAR JOINT AIR-WATER 20 BAR	1
KG224	SNODO ACQUA 400 BAR JOINT WATER 400 BAR	1
KG239	CARTER-MOLLA COVER SPRING-GROUP	1
P051	BOCCOLA LATO CREMAGLIERA BUSH	1
P052	BOCCOLA LATO MOLLA BUSH	1

ELENCO GUARNIZIONI SNODI
 JOINTS GASKETS LIST

CODICE CODE	DESCRIZIONE DESCRIPTION	Q.TÀ QTY
H160	O-RING 2093 O-RING 2093	1
H183	GUARNIZIONE GASKET	1
H242	GUARNIZIONE M4 1810-PUR95 GASKET	1
H267	GUARNIZIONE VITON 90SH GASKET	1
H288	RONDELLA IN PTFE PTFE WASHER	1
H302	RONDELLA IN PTFE PTFE WASHER	1
H310	GUARNIZIONE OR 112 VITON GASKET	1
H367	GUARNIZIONE GASKET	1
H368	RONDELLA IN PTFE PTFE WASHER	1
H370	GUARNIZIONE OR 2062 VITON GASKET	1
H371	GUARNIZIONE OR 2037 VITON GASKET	1
H394	RONDELLA IN PTFE PTFE WASHER	1
H395	RONDELLA IN PTFE PTFE WASHER	1

tutti i diritti riservati - all rights reserved



Art. 8560.100 Mod. 560-1"-20 bar - Art. 8560.200 Mod. 560-1"-100 bar
 Art. 8560.400 Mod. 560-1"-150 bar



VISTA ESPLOSA - EXPLODED VIEW

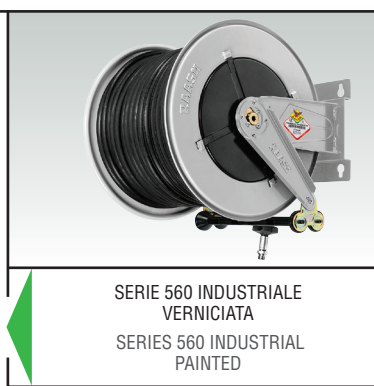
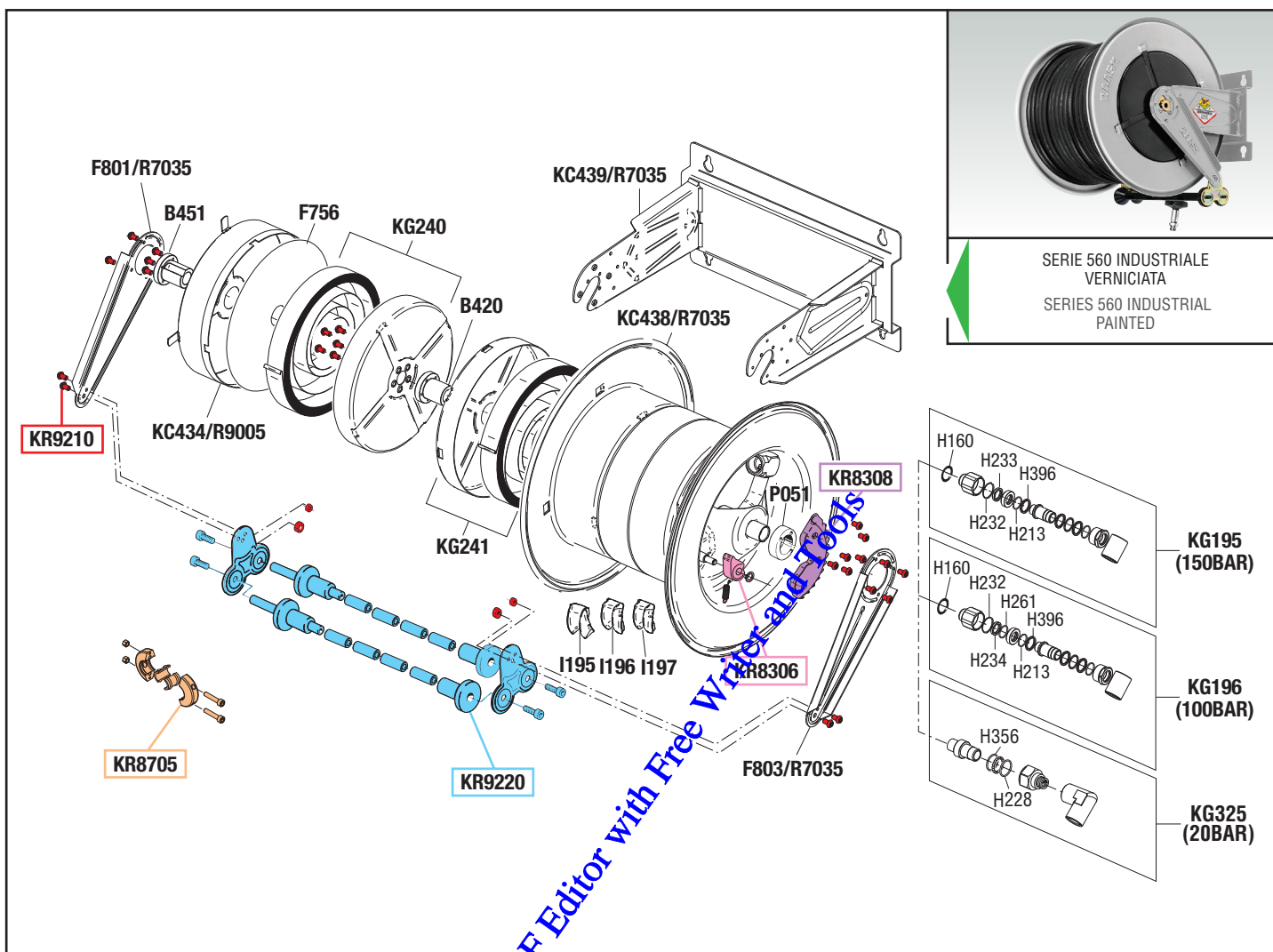

GUIDA RICAMBI - SPARE PARTS GUIDE

KIT RICAMBI
 OGNI KIT SOTTO RIPORTATO COMPRENDE I RICAMBI EVIDENZIATI CON LO STESSO COLORE E LE RELATIVE GUARNIZIONI. QUESTI RICAMBI NON SONO FORNIBILI SEPARATAMENTE TRANNE QUELLI CODIFICATI.

SPARE PARTS KITS
 EACH KIT SHOWN WITH THE SAME COLOR INCLUDES ALSO THE GASKETS. THE SPARE PARTS INCLUDED IN THE KIT CAN'T BE SUPPLIED SEPARATELY EXCEPT THOSE SHOWN WITH A PROPER CODE.

CODICE CODE	DESCRIZIONE DESCRIPTION	Q.TÀ QTY
KR8306	DENTE D'ARRESTO DETENT	1
KR8308	KIT CREMAGLIERA RACK KIT	1
KR8705	TAMPONE FERMATUBO HOSE STOP	1
KR9210	SET VITI ARROTOLATORE SET OF SCREWS FOR HOSE REEL	1
KR9220	KIT PORTA RULLI ARROTOLATORE ROLLERS HOLDING KIT FOR HOSE REEL	1

ELENCO RICAMBI FORNIBILI SINGOLARMENTE
 LIST OF SPARE PARTS WHICH CAN BE SUPPLIED SEPARATELY

CODICE CODE	DESCRIZIONE DESCRIPTION	Q.TÀ QTY
B420	BOCCOLA PORTA MOLLA BUSH	1
B451	BOCCOLA ESTERNA EXTERNAL BUSH	1
F756	CARTER-MOLLA COVER-SPRING GROUP	1
F801/R7035	BRACCIO ORIENTABILE SWINGING ARM	1
F803/R7035	BRACCIO ORIENTABILE SWINGING ARM	1
I195	INSERTO USCITA TUBO Ø34-38 HOSE OUTLET PROTECTION	1
I196	INSERTO USCITA TUBO Ø30-34 HOSE OUTLET PROTECTION	1
I197	INSERTO USCITA TUBO Ø26-30 HOSE OUTLET PROTECTION	1
KC434/R9005	CARTER COVER	1
KC438/R7035	TAMBURO 510 510 HOSE REEL DRUM	1
KC439/R7035	STAFFA BRACKET	1
KG195	SNODO OLIO 150 BAR JOINT OIL 150 BAR	1
KG196	SNODO ACQUA 100 BAR JOINT WATER 100 BAR	1
KG240	CARTER-MOLLA COVER-SPRING GROUP	1
KG241	CARTER-MOLLA COVER-SPRING GROUP	1
KG325	SNODO ALTA PORTATA 1" G JOINT HIGH FLOW 1" G	1
P051	BOCCOLA LATO CREMAGLIERA BUSH	1

ELENCO GUARNIZIONI SNODI
 JOINTS GASKETS LIST

CODICE CODE	DESCRIZIONE DESCRIPTION	Q.TÀ QTY
H160	O-RING 2093 O-RING 2093	1
H213	O-RING 2087 VITON O-RING 2087 VITON	1
H228	O-RING 4112 VITON O-RING 4112 VITON	1
H232	GUARNIZIONE GASKET	1
H233	GUARNIZIONE GASKET	1
H234	O-RING 2131 DI 087 VITON O-RING 2131 DI 087 VITON	1
H261	RONDELLA IN PTFE PTFE WASHER	1
H356	O-RING 3106 VITON O-RING 3106 VITON	1
H396	RONDELLA IN PTFE PTFE WASHER	1

tutti i diritti riservati - all rights reserved



Art. 8560.106 Mod. 560-1/2"-20 bar - Art. 8560.206 Mod. 560-1/2"-100 bar
 Art. 8560.300 Mod. 560-200 bar - Art. 8560.350 Mod. 560-400 bar
 Art. 8560.406 Mod. 560-1/2"-150 bar



VISTA ESPLOSA - EXPLODED VIEW

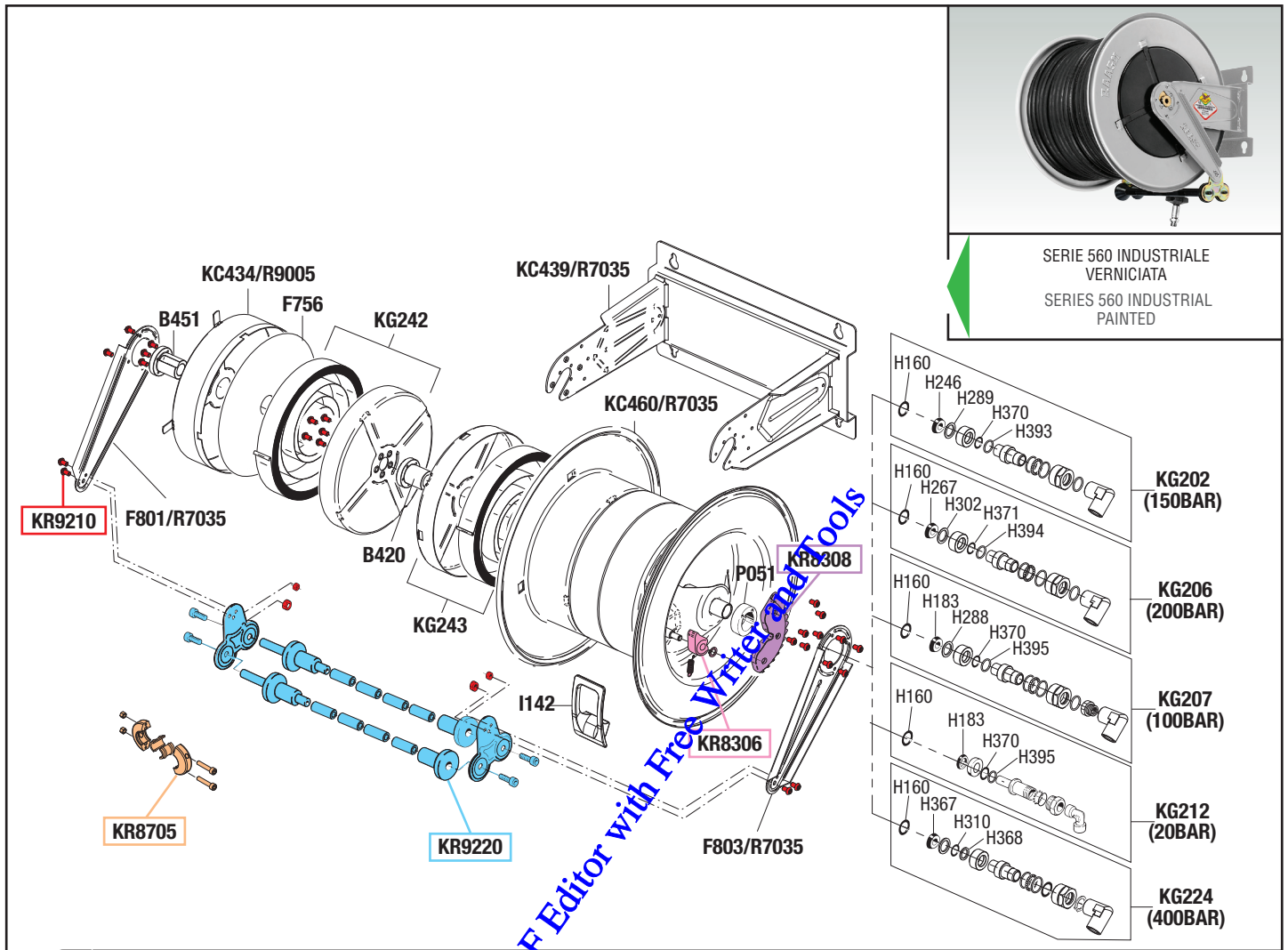

tutti i diritti riservati - all rights reserved

GUIDA RICAMBI - SPARE PARTS GUIDE

KIT RICAMBI

OGNI KIT SOTTO RIPORTATO COMPRENDE I RICAMBI EVIDENZIATI CON LO STESSO COLORE E LE RELATIVE GUARNIZIONI. QUESTI RICAMBI NON SONO FORNIBILI SEPARATAMENTE TRANNE QUELLI CODIFICATI.

SPARE PARTS KITS

EACH KIT SHOWN WITH THE SAME COLOR INCLUDES ALSO THE GASKETS. THE SPARE PARTS INCLUDED IN THE KIT CAN'T BE SUPPLIED SEPARATELY EXCEPT THOSE SHOWN WITH A PROPER CODE.

CODICE CODE	DESCRIZIONE DESCRIPTION	Q.TÀ QTY
KR8306	DENTE D'ARRESTO DETENT	1
KR8308	KIT CREMAGLIERA RACK KIT	1
KR8705	TAMPONE FERMATUBO HOSE STOP	1
KR9210	SET VITI ARROTOLATORE SET OF SCREWS FOR HOSE REEL	1
KR9220	KIT PORTA RULLI ARROTOLATORE ROLLERS HOLDING KIT FOR HOSE REEL	1

ELENCO RICAMBI FORNIBILI SINGOLARMENTE

LIST OF SPARE PARTS WHICH CAN BE SUPPLIED SEPARATELY

CODICE CODE	DESCRIZIONE DESCRIPTION	Q.TÀ QTY
B420	BOCCOLA PORTA MOLLA BUSH	1
B451	BOCCOLA ESTERNA EXTERNAL BUSH	1
F756	CARTER-MOLLA COVER-SPRING GROUP	1
F801/R7035	BRACCIO ORIENTABILE SWINGING ARM	1
F803/R7035	BRACCIO ORIENTABILE SWINGING ARM	1
I142	INSERTO USCITA TUBO HOSE OUTLET PROTECTION	1
KC434/R9005	CARTER COVER	1
KC439/R7035	STAFFA BRACKET	1
KC460/R7035	TAMBURO 510 510 HOSE REEL DRUM	1
KG202	SNODO OLIO 150 BAR JOINT OIL 150 BAR	1
KG206	SNODO ACQUA 200 BAR JOINT WATER 200 BAR	1
KG207	SNODO ACQUA 100 BAR JOINT WATER 100 BAR	1
KG212	SNODO ARIA-ACQUA 20 BAR JOINT AIR-WATER 20 BAR	1
KG224	SNODO ACQUA 400 BAR JOINT WATER 400 BAR	1
KG242	CARTER-MOLLA COVER-SPRING-GROUP	1
KG243	CARTER-MOLLA COVER-SPRING-GROUP	1
P051	BOCCOLA LATO CREMAGLIERA BUSH	1

ELENCO GUARNIZIONI SNODI

JOINTS GASKETS LIST

CODICE CODE	DESCRIZIONE DESCRIPTION	Q.TÀ QTY
H160	O-RING 2093 O-RING 2093	1
H183	GUARNIZIONE GASKET	1
H246	GUARNIZIONE GASKET	1
H267	GUARNIZIONE VITON 90SH GASKET	1
H288	RONDELLA IN PTFE PTFE WASHER	1
H289	RONDELLA IN PTFE PTFE WASHER	1
H302	RONDELLA IN PTFE PTFE WASHER	1
H310	GUARNIZIONE OR 112 VITON GASKET	1
H367	GUARNIZIONE GASKET	1
H368	RONDELLA IN PTFE PTFE WASHER	1
H370	GUARNIZIONE OR 2062 VITON GASKET	1
H371	GUARNIZIONE OR 2037 VITON GASKET	1
H393	RONDELLA IN PTFE PTFE WASHER	1
H394	RONDELLA IN PTFE PTFE WASHER	1
H395	RONDELLA IN PTFE PTFE WASHER	1



Art. 8562.100 Mod. 562-1"-20 bar - Art. 8564.200 Mod. 564-1"-150 bar



VISTA ESPLOSA - EXPLODED VIEW

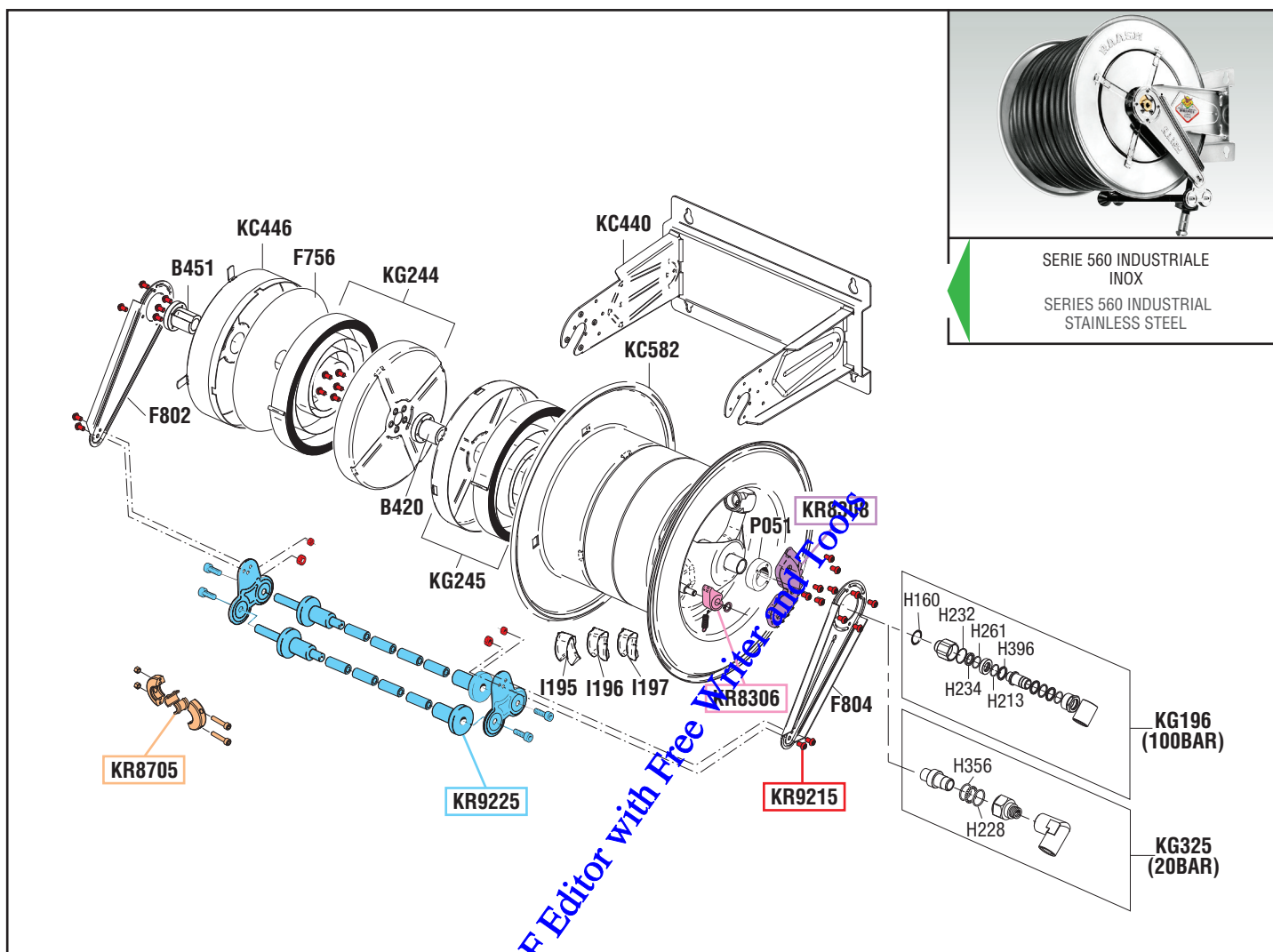

SERIE 560 INDUSTRIALE
INOX
SERIES 560 INDUSTRIAL
STAINLESS STEEL

tutti i diritti riservati - all rights reserved

GUIDA RICAMBI - SPARE PARTS GUIDE

KIT RICAMBI

OGNI KIT SOTTO RIPORTATO COMPRENDE I RICAMBI EVIDENZIATI CON LO STESSO COLORE E LE RELATIVE GUARNIZIONI. QUESTI RICAMBI NON SONO FORNIBILI SEPARATAMENTE TRANNE QUELLI CODIFICATI.

SPARE PARTS KITS

EACH KIT SHOWN WITH THE SAME COLOR INCLUDES ALSO THE GASKETS. THE SPARE PARTS INCLUDED IN THE KIT CAN'T BE SUPPLIED SEPARATELY EXCEPT THOSE SHOWN WITH A PROPER CODE.

CODICE CODE	DESCRIZIONE DESCRIPTION	Q. TÀ QTY
KR8306	DENTE D'ARRESTO DETENT	1
KR8308	KIT CREMAGLIERA RACK KIT	1
KR8705	TAMPONE FERMATUBO HOSE STOP	1
KR9215	SET VITI ARROTOLATORE SET OF SCREWS FOR HOSE REEL	1
KR9225	KIT PORTA RULLI ARROTOLATORE ROLLERS HOLDING KIT FOR HOSE REEL	1

ELENCO RICAMBI FORNIBILI SINGOLARMENTE

LIST OF SPARE PARTS WHICH CAN BE SUPPLIED SEPARATELY

CODICE CODE	DESCRIZIONE DESCRIPTION	Q. TÀ QTY
B420	BOCCOLA PORTA MOLLA BUSH	1
B451	BOCCOLA ESTERNA EXTERNAL BUSH	1
F756	CARTER-MOLLA COVER-SPRING GROUP	1
F802	BRACCIO ORIENTABILE SWINGING ARM	1
F804	BRACCIO ORIENTABILE SWINGING ARM	1
I195	INSERTO USCITA TUBO Ø34-38 HOSE OUTLET PROTECTION	1
I196	INSERTO USCITA TUBO Ø30-34 HOSE OUTLET PROTECTION	1
I197	INSERTO USCITA TUBO Ø26-30 HOSE OUTLET PROTECTION	1
KC440	STAFFA BRACKET	1
KC446	CARTER COVER	1
KC582	TAMBURO 510 510 HOSE REEL DRUM	1
KG196	SNODO ACQUA 100 BAR JOINT WATER 100 BAR	1
KG244	CARTER-MOLLA COVER-SPRING-GROUP	1
KG245	CARTER-MOLLA COVER-SPRING-GROUP	1
KG325	SNODO ALTA PORTATA 1" G JOINT HIGH FLOW 1" G	1
P051	BOCCOLA LATO CREMAGLIERA BUSH	1

ELENCO GUARNIZIONI SNODI

JOINTS GASKETS LIST

CODICE CODE	DESCRIZIONE DESCRIPTION	Q. TÀ QTY
H160	O-RING 2093 O-RING 2093	1
H213	GUARNIZIONE OR 2087 VITON GASKET	1
H228	O-RING 4112 VITON O-RING 4112 VITON	1
H232	GUARNIZIONE OR 2131 GASKET	1
H234	GUARNIZIONE DI 087 VITON GASKET	1
H261	RONDELLA IN PTFE PTFE WASHER	1
H356	O-RING 3106 VITON O-RING 3106 VITON	1
H396	RONDELLA IN PTFE PTFE WASHER	1



Art. 8562.106 Mod. 562-1/2"-20 bar - Art. 8564.206 Mod. 564-1/2"-100 bar
 Art. 8564.300 Mod. 564-200 bar - Art. 8564.350 Mod. 564-400 bar



VISTA ESPLOSA - EXPLODED VIEW

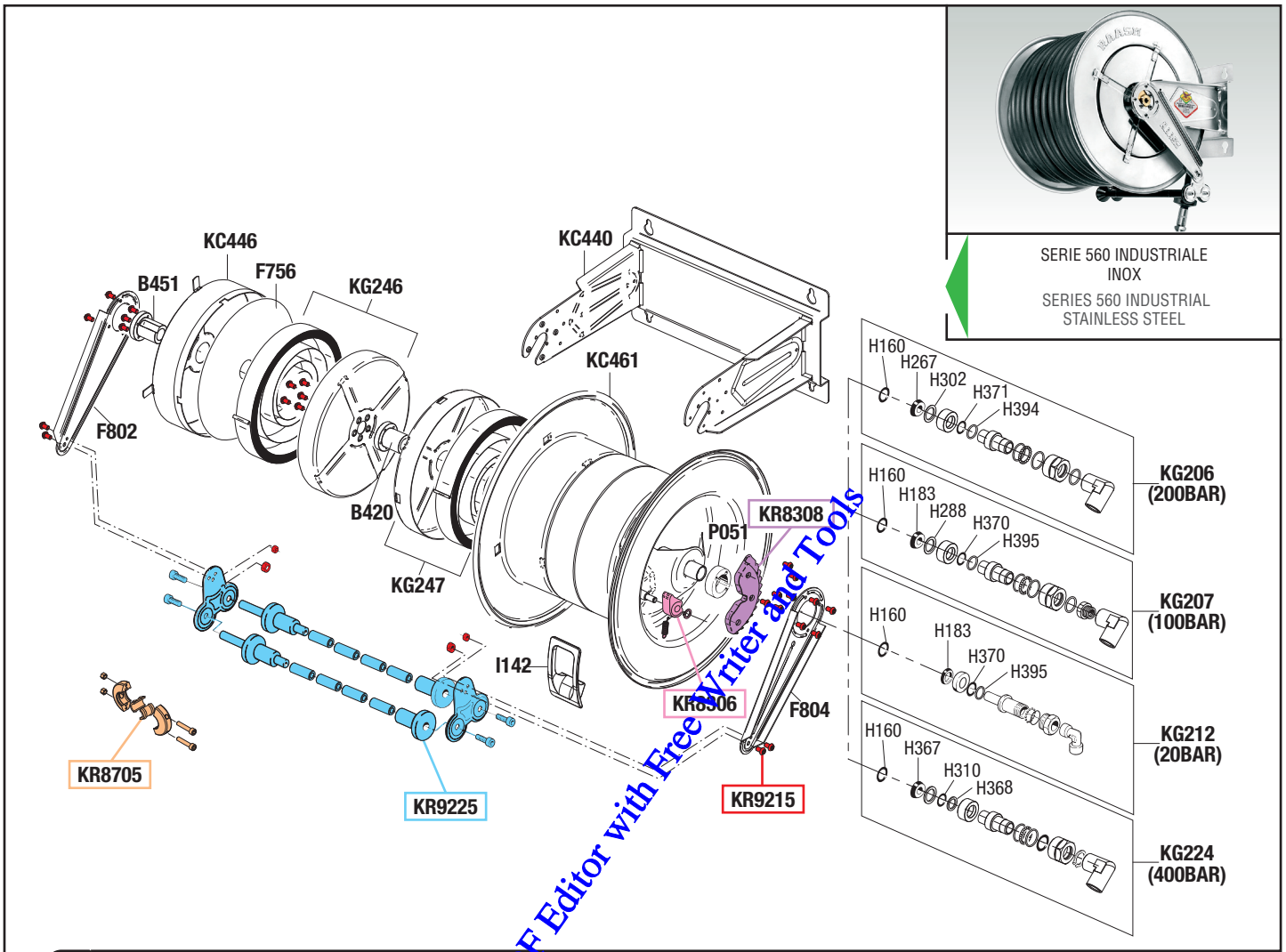

SERIE 560 INDUSTRIALE INOX
 SERIES 560 INDUSTRIAL STAINLESS STEEL

GUIDA RICAMBI - SPARE PARTS GUIDE

KIT RICAMBI

OGNI KIT SOTTO RIPORTATO COMPRENDE I RICAMBI EVIDENZIATI CON LO STESSO COLORE E LE RELATIVE GUARNIZIONI. QUESTI RICAMBI NON SONO FORNIBILI SEPARATAMENTE TRANNE QUELLI CODIFICATI.

SPARE PARTS KITS

EACH KIT SHOWN WITH THE SAME COLOR INCLUDES ALSO THE GASKETS. THE SPARE PARTS INCLUDED IN THE KIT CAN'T BE SUPPLIED SEPARATELY EXCEPT THOSE SHOWN WITH A PROPER CODE.

CODICE CODE	DESCRIZIONE DESCRIPTION	Q.TÀ QTY
KR8306	DENTE D'ARRESTO DETENT	1
KR8308	KIT CREMAGLIERA RACK KIT	1
KR8705	TAMPONE FERMATUBO HOSE STOP	1
KR9215	SET VITI ARROTOLATORE SET OF SCREWS FOR HOSE REEL	1
KR9225	KIT PORTA RULLI ARROTOLATORE ROLLERS HOLDING KIT FOR HOSE REEL	1

ELENCO RICAMBI FORNIBILI SINGOLARMENTE

LIST OF SPARE PARTS WHICH CAN BE SUPPLIED SEPARATELY

CODICE CODE	DESCRIZIONE DESCRIPTION	Q.TÀ QTY
B420	BOCCOLA PORTA MOLLA BUSH	1
B451	BOCCOLA ESTERNA EXTERNAL BUSH	1
F756	CARTER-MOLLA COVER-SPRING GROUP	1
F802	BRACCIO ORIENTABILE SWINGING ARM	1
F804	BRACCIO ORIENTABILE SWINGING ARM	1
I142	INSERTO FORO USCITA TUBO HOSE OUTLET PROTECTION	1
KC440	STAFFA BRACKET	1
KC446	CARTER COVER	1
KC461	TAMBURO 510 510 HOSE REEL DRUM	1
KG206	SNODO ACQUA 200 BAR JOINT WATER 200 BAR	1
KG207	SNODO ACQUA 100 BAR JOINT WATER 100 BAR	1
KG212	SNODO ARIA-ACQUA 20 BAR JOINT AIR-WATER 20 BAR	1
KG224	SNODO ACQUA 400 BAR JOINT WATER 400 BAR	1
KG246	CARTER-MOLLA COVER-SPRING-GROUP	1
KG247	CARTER-MOLLA COVER-SPRING-GROUP	1
P051	BOCCOLA LATO CREMAGLIERA BUSH	1

ELENCO GUARNIZIONI SNODI

JOINTS GASKETS LIST

CODICE CODE	DESCRIZIONE DESCRIPTION	Q.TÀ QTY
H160	O-RING 2093 O-RING 2093	1
H183	GUARNIZIONE GASKET	1
H267	RONDELLA "VITON" 90SH VITON WASHER	1
H288	RONDELLA IN PTFE PTFE WASHER	1
H302	RONDELLA IN PTFE PTFE WASHER	1
H310	GUARNIZIONE OR 112 VITON GASKET	1
H367	GUARNIZIONE GASKET	1
H368	RONDELLA IN PTFE PTFE WASHER	1
H370	GUARNIZIONE OR 2062 VITON GASKET	1
H371	GUARNIZIONE OR 2037 VITON GASKET	1
H394	RONDELLA IN PTFE PTFE WASHER	1
H395	RONDELLA IN PTFE PTFE WASHER	1

tutti i diritti riservati - all rights reserved



Art. 8617.100 Mod. 617-20 bar - Art. 8617.200 Mod. 617-100 bar
 Art. 8617.400 Mod. 617-150 bar - Art. 8617.500 Mod. 617-400 bar



VISTA ESPLOSA - EXPLODED VIEW

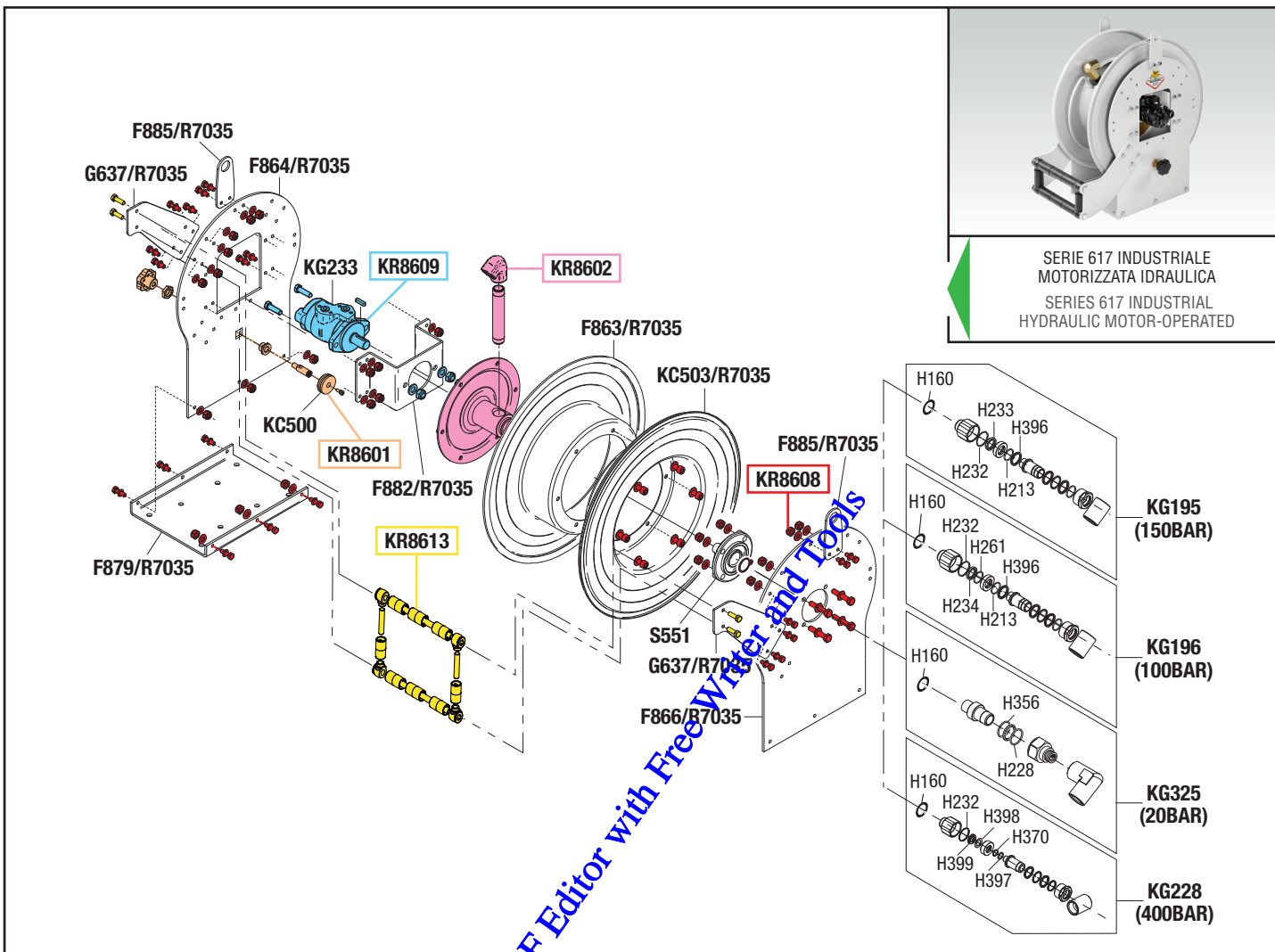

SERIE 617 INDUSTRIALE
 MOTORIZZATA IDRAULICA
 SERIES 617 INDUSTRIAL
 HYDRAULIC MOTOR-OPERATED

- H160 H233 H396 H232 H213 **KG195 (150BAR)**
- H160 H232 H261 H396 H234 H213 **KG196 (100BAR)**
- H160 H356 H228 **KG325 (20BAR)**
- H160 H232 H398 H370 H399 H397 **KG228 (400BAR)**

GUIDA RICAMBI - SPARE PARTS GUIDE

KIT RICAMBI
 OGNI KIT SOTTO RIPORTATO COMPRENDE I RICAMBI EVIDENZIATI CON LO STESSO COLORE E LE RELATIVE GUARNIZIONI. QUESTI RICAMBI NON SONO FORNIBILI SEPARATAMENTE TRANNE QUELLI CODIFICATI.
SPARE PARTS KITS
 EACH KIT SHOWN WITH THE SAME COLOR INCLUDES ALSO THE GASKETS. THE SPARE PARTS INCLUDED IN THE KIT CAN'T BE SUPPLIED SEPARATELY EXCEPT THOSE SHOWN WITH A PROPER CODE.

CODICE CODE	DESCRIZIONE DESCRIPTION	Q.TÀ QTY
KR8601	KIT TAMPONE STOPPER KIT	1
KR8602	GRUPPO PERNO CENTRALE CENTRAL PIVOT KIT	1
KR8608	SET VITI ARROTOLATORE SET OF SCREWS HOSEREEL	1
KR8609	GRUPPO MOTORE IDRAULICO HYDRAULIC MOTOR KIT	1
KR8613	KIT PORTA RULLI ARROTOLATORE ROLLERS HOLDING KIT FOR HOSEREEL	1

ELENCO RICAMBI FORNIBILI SINGOLARMENTE
LIST OF SPARE PARTS WHICH CAN BE SUPPLIED SEPARATELY

CODICE CODE	DESCRIZIONE DESCRIPTION	Q.TÀ QTY
F863/R7035	FLANGIA LATO MOTORE MOTOR SIDE FLANGE	1
F864/R7035	STAFFA LATO TRAZIONE TRACTION SIDE BRACKET	1
F866/R7035	STAFFA LATO SNODO SWIVELLING BRACKET	1
F879/R7035	BASE ARROTOLATORE HOSEREEL BASE	1
F882/R7035	SUPPORTO MOTORE IDRAULICO HYDRAULIC MOTOR SUPPORT	1
F885/R7035	GANCIO SOLLEVAMENTO HOOK	2
G637/R7035	BRACCIO ORIENTABILE JOINT SIDE BRACKET	2
KC500	TAMPONE FRENO STOPPER	1
KC503/R7035	FLANGIA LATO SNODO JOINT SIDE FLANGE	1
KG195	SNODO OLIO 150 BAR JOINT OIL 150 BAR	1
KG196	SNODO ACQUA 100 BAR JOINT WATER 100 BAR	1
KG325	SNODO ARIA-ACQUA 20 BAR JOINT AIR-WATER 20 BAR	1
KG228	SNODO ALTA PORTATA 1" 400 BAR JOINT HIGH DELIVERY 1" 400 BAR	1
KG233	MOTORE IDRAULICO HYDRAULIC MOTOR	1
S551	SUPPORTO CUSCINETTO BEARING SUPPORT	1

ELENCO GUARNIZIONI SNODI
JOINTS GASKETS LIST

CODICE CODE	DESCRIZIONE DESCRIPTION	Q.TÀ QTY
H160	O-RING 2093 O-RING 2093	1
H213	GUARNIZIONE OR 2087 VITON GASKET	1
H228	O-RING 4112 "VITON" O-RING 4112 "VITON"	1
H232	GUARNIZIONE OR 2131 GASKET	1
H233	GUARNIZIONE GASKET	1
H234	GUARNIZIONE DI 087 VITON GASKET	1
H261	RONDELLA IN PTFE PTFE WASHER	1
H356	O-RING 3106 "VITON" O-RING 3106 "VITON"	1
H370	GUARNIZIONE OR 2062 VITON GASKET	1
H396	RONDELLA IN PTFE PTFE WASHER	1
H397	RONDELLA IN PTFE PTFE WASHER	1
H398	RONDELLA IN PTFE PTFE WASHER	1
H399	GUARNIZIONE GASKET	1

tutti i diritti riservati - all rights reserved



Art. 8617.600 Mod. 617-10 bar



VISTA ESPLOSA - EXPLODED VIEW

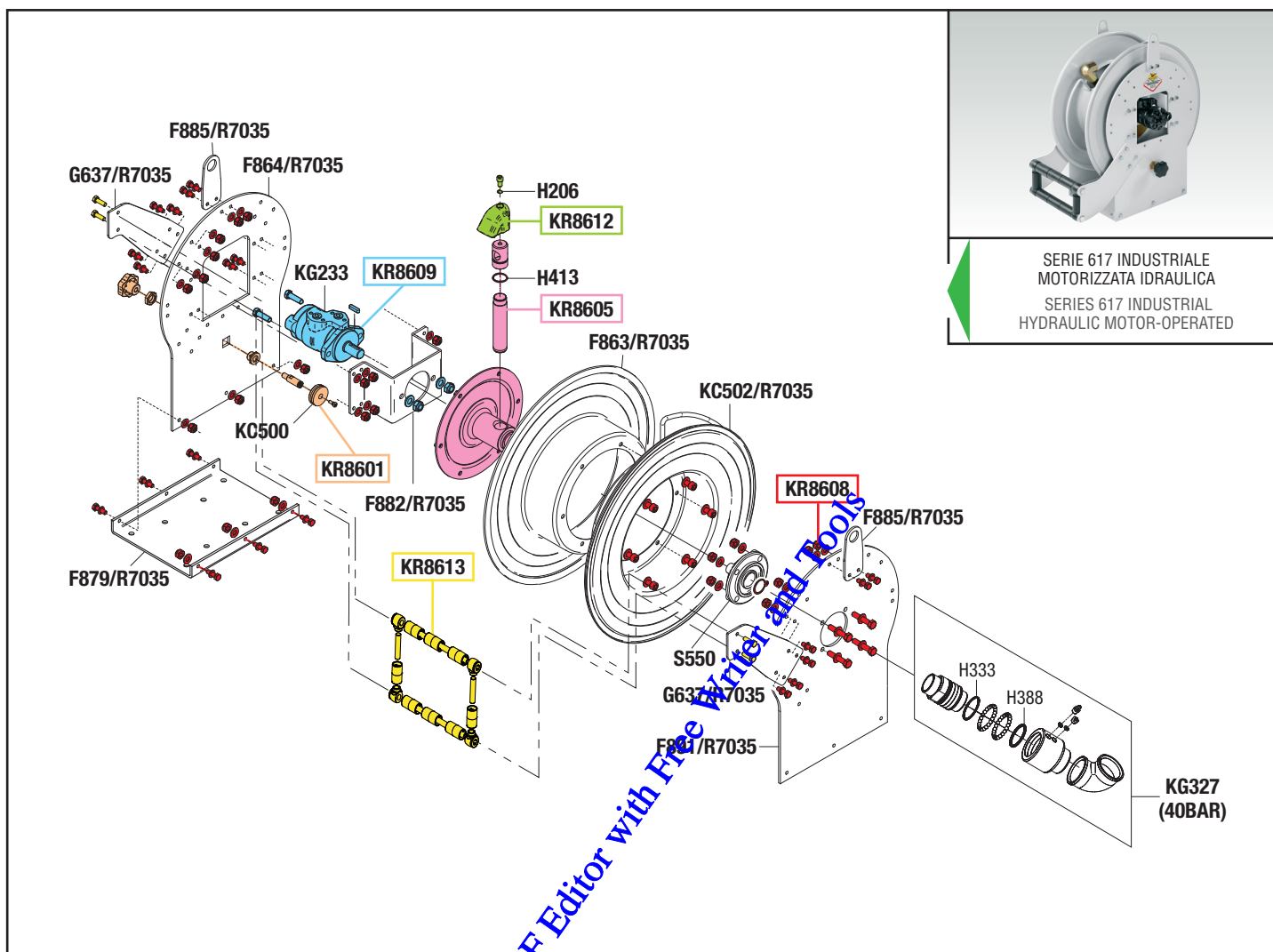

SERIE 617 INDUSTRIALE
MOTORIZZATA IDRAULICA
SERIES 617 INDUSTRIAL
HYDRAULIC MOTOR-OPERATED

GUIDA RICAMBI - SPARE PARTS GUIDE

KIT RICAMBI

OGNI KIT SOTTO RIPORTATO COMPRENDE I RICAMBI EVIDENZIATI CON LO STESSO COLORE E LE RELATIVE GUARNIZIONI. QUESTI RICAMBI NON SONO FORNIBILI SEPARATAMENTE TRANNE QUELLI CODIFICATI.

SPARE PARTS KITS

EACH KIT SHOWN WITH THE SAME COLOR INCLUDES ALSO THE GASKETS. THE SPARE PARTS INCLUDED IN THE KIT CAN'T BE SUPPLIED SEPARATELY EXCEPT THOSE SHOWN WITH A PROPER CODE.

CODICE CODE	DESCRIZIONE DESCRIPTION	Q.TÀ QTY
KR8601	KIT TAMPONE STOPPER KIT	1
KR8605	GRUPPO PERNO CENTRALE CENTRAL PIVOT KIT	1
KR8608	SET VITI ARROTOLATORE SET OF SCREWS HOSEREEL	1
KR8609	GRUPPO MOTORE IDRAULICO HYDRAULIC MOTOR KIT	1
KR8612	ATTACCO TUBO HOSE CONNECTION	1
KR8613	KIT PORTA RULLI ARROTOLATORE ROLLERS HOLDING KIT FOR HOSEREEL	1

ELENCO RICAMBI FORNIBILI SINGOLARMENTE

LIST OF SPARE PARTS WHICH CAN BE SUPPLIED SEPARATELY

CODICE CODE	DESCRIZIONE DESCRIPTION	Q.TÀ QTY
F863/R7035	FLANGIA LATO MOTORE MOTOR SIDE FLANGE	1
F864/R7035	STAFFA LATO TRAZIONE TRACTION SIDE BRACKET	1
F879/R7035	BASE ARROTOLATORE HOSEREEL BASE	1
F882/R7035	SUPPORTO MOTORE IDRAULICO HYDRAULIC MOTOR SUPPORT	1
F885/R7035	GANCIO SOLLEVAMENTO HOOK	2
F891/R7035	STAFFA LATO SNODO SWIVELLING BRACKET	1
G637/R7035	BRACCIO ORIENTABILE JOINT SIDE BRACKET	1
H206	GUARNIZIONE OR 3043 VITON GASKET	1
H413	GUARNIZIONE OR 4150 VITON GASKET	1
KC500	TAMPONE FRENO STOPPER	1
KC502/R7035	FLANGIA LATO SNODO JOINT SIDE FLANGE	1
KG233	MOTORE IDRAULICO HYDRAULIC MOTOR	1
KG327	SNODO ALTA PORTATA 1. 1/2" 40 BAR JOINT HIGH DELIVERY 1. 1/2" 40 BAR	1
S550	SUPPORTO CUSCINETTO BEARING SUPPORT	1

ELENCO GUARNIZIONI SNODI

JOINTS GASKETS LIST

CODICE CODE	DESCRIZIONE DESCRIPTION	Q.TÀ QTY
H160	O-RING 2093 O-RING 2093	1
H313	GUARNIZIONE OR 3156 VITON GASKET	1
H413	GUARNIZIONE OR 4150 VITON GASKET	1
H427	RONDELLA IN PTFE PTFE WASHER	1

tutti i diritti riservati - all rights reserved



Art. 8618.100 Mod. 618-20 bar - Art. 8618.200 Mod. 618-100 bar
 Art. 8618.400 Mod. 618-150 bar - Art. 8618.500 Mod. 618-400 bar



VISTA ESPLOSA - EXPLODED VIEW

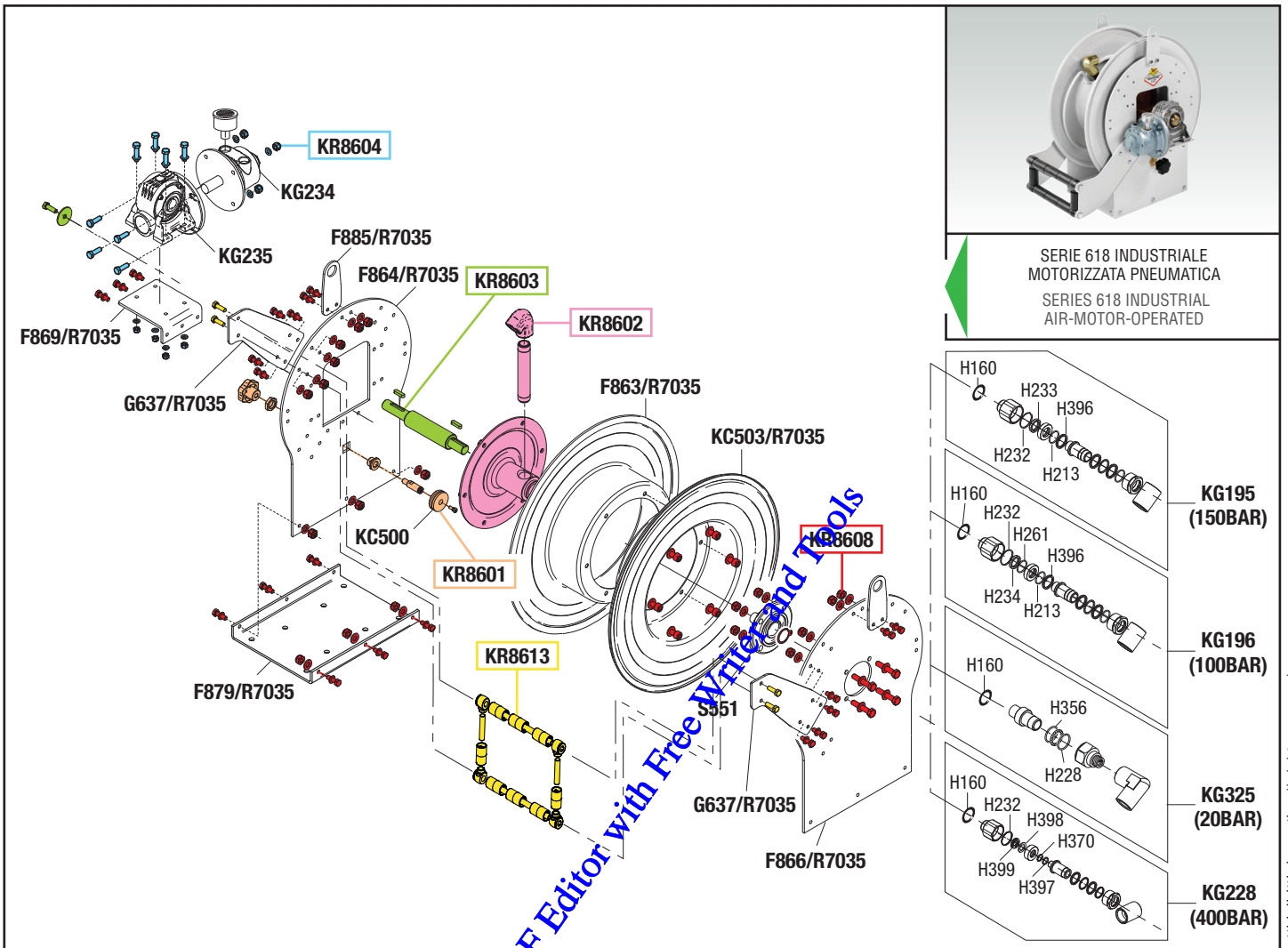

SERIE 618 INDUSTRIALE
 MOTORIZZATA PNEUMATICA
 SERIES 618 INDUSTRIAL
 AIR-MOTOR-OPERATED

- H160 H233 H396 H232 H213
 - H160 H232 H261 H396 H234 H213
 - H160 H356 H228
 - H160 H232 H398 H370 H399 H397
- KG195 (150BAR)
- KG196 (100BAR)
- KG325 (20BAR)
- KG228 (400BAR)

tutti i diritti riservati - all rights reserved

GUIDA RICAMBI - SPARE PARTS GUIDE

KIT RICAMBI
 OGNI KIT SOTTO RIPORTATO COMPRENDE I RICAMBI EVIDENZIATI CON LO STESSO COLORE E LE RELATIVE GUARNIZIONI. QUESTI RICAMBI NON SONO FORNIBILI SEPARATAMENTE TRANNE QUELLI CODIFICATI.

SPARE PARTS KITS
 EACH KIT SHOWN WITH THE SAME COLOR INCLUDES ALSO THE GASKETS. THE SPARE PARTS INCLUDED IN THE KIT CAN'T BE SUPPLIED SEPARATELY EXCEPT THOSE SHOWN WITH A PROPER CODE.

CODICE CODE	DESCRIZIONE DESCRIPTION	Q.TÀ QTY
KR8601	KIT TAMPONE STOPPER KIT	1
KR8602	GRUPPO PERNO CENTRALE CENTRAL PIVOT KIT	1
KR8603	ALBERO MOTORE MOTOR SHAFT	1
KR8604	SET VITI MOTORE SET OF MOTOR SCREWS	1
KR8608	SET VITI ARROTOLATORE SET OF SCREWS HOSEREEL	1
KR8613	KIT PORTA RULLI ARROTOLATORE ROLLERS HOLDING KIT FOR HOSEREEL	1

ELENCO RICAMBI FORNIBILI SINGOLARMENTE
 LIST OF SPARE PARTS WHICH CAN BE SUPPLIED SEPARATELY

CODICE CODE	DESCRIZIONE DESCRIPTION	Q.TÀ QTY
F863/R7035	FLANGIA LATO MOTORE MOTOR SIDE FLANGE	1
F864/R7035	STAFFA LATO TRAZIONE TRACTION SIDE BRACKET	1
F866/R7035	STAFFA LATO SNODO SWIVELLING BRACKET	1
F869/R7035	SUPPORTO MOTORE MOTOR SUPPORT	1
F879/R7035	BASE ARROTOLATORE HOSEREEL BASE	1
F885/R7035	GANCIO SOLLEVAMENTO HOOK	2
G637/R7035	BRACCIO ORIENTABILE JOINT SIDE BRACKET	2
KC500	TAMPONE FRENO STOPPER	1
KC503/R7035	FLANGIA LATO SNODO JOINT SIDE FLANGE	1
KG195	SNODO OLIO 150 BAR JOINT OIL 150 BAR	1
KG196	SNODO ACQUA 100 BAR JOINT WATER 100 BAR	1
KG228	SNODO ALTA PORTATA 1" 400 BAR JOINT HIGH DELIVERY 1" 400 BAR	1
KG234	MOTORE PNEUMATICO PNEUMATIC MOTOR	1
KG235	RIDUTTORE REDUCTION GEAR	1
KG325	SNODO ARIA-ACQUA 20 BAR JOINT AIR-WATER 20 BAR	1
S551	SUPPORTO CUSCINETTO BEARING SUPPORT	1

ELENCO GUARNIZIONI SNODI
 JOINTS GASKETS LIST

CODICE CODE	DESCRIZIONE DESCRIPTION	Q.TÀ QTY
H160	O-RING 2093 O-RING 2093	1
H213	O-RING 2087 VITON O-RING 2087 VITON	1
H228	O-RING 4112 VITON O-RING 4112 VITON	1
H232	O-RING 2131 O-RING 2131	1
H233	GUARNIZIONE GASKET	1
H234	GUARNIZIONE DI 087 VITON GASKET	1
H261	RONDELLA IN PTFE PTFE WASHER	1
H356	O-RING 3106 VITON O-RING 3106 VITON	1
H370	O-RING 2062 VITON O-RING 2062 VITON	1
H396	RONDELLA IN PTFE PTFE WASHER	1
H397	RONDELLA IN PTFE PTFE WASHER	1
H398	RONDELLA IN PTFE PTFE WASHER	1
H399	GUARNIZIONE GASKET	1



Art. 8637.100 Mod. 637-20 bar - Art. 8637.200 Mod. 637-100 bar
Art. 8637.400 Mod. 637-150 bar - Art. 8637.500 Mod. 637-400 bar



VISTA ESPLOSA - EXPLODED VIEW

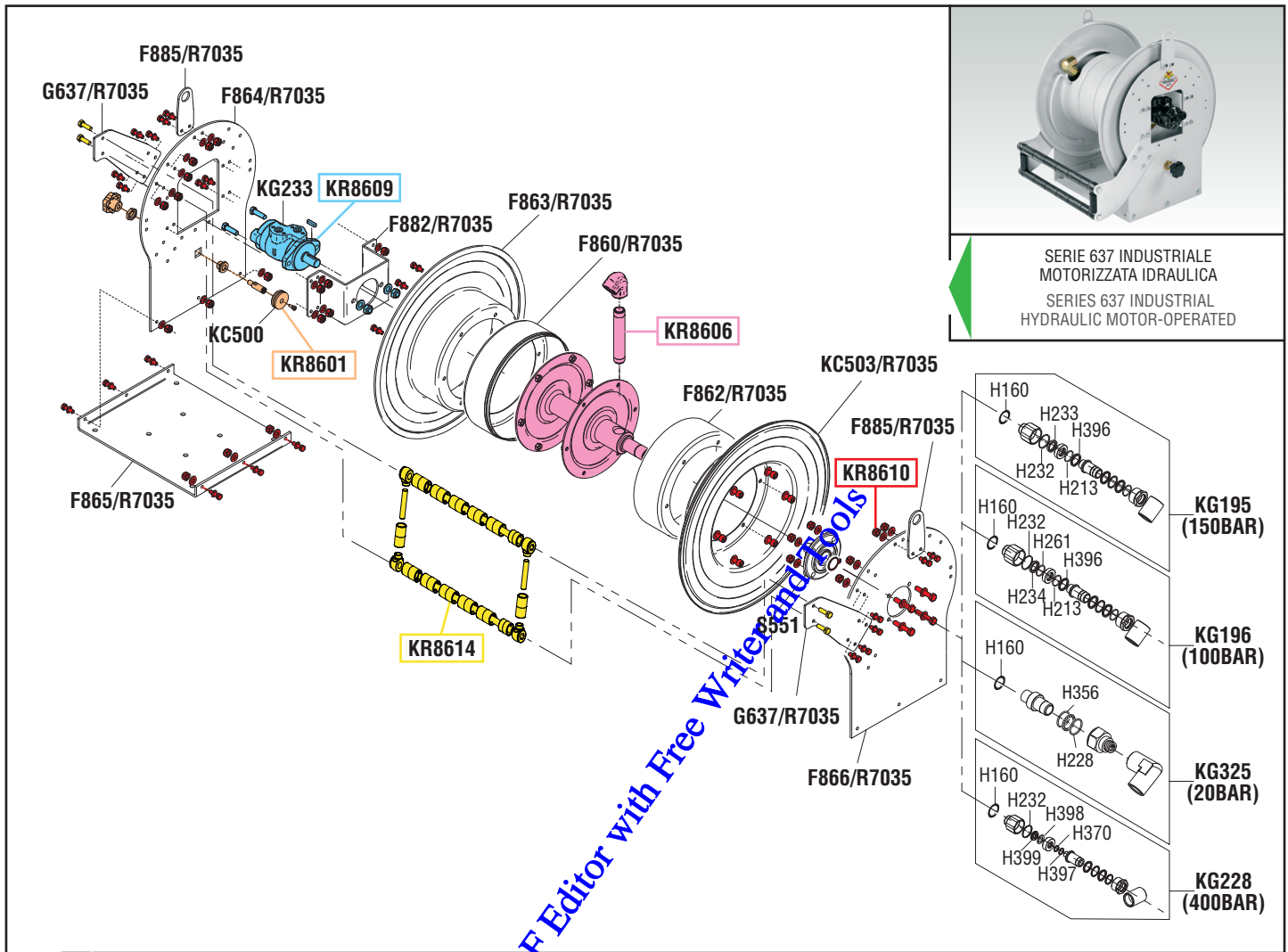

SERIE 637 INDUSTRIALE
MOTORIZZATA IDRAULICA
SERIES 637 INDUSTRIAL
HYDRAULIC MOTOR-OPERATED

KG195
(150BAR)

KG196
(100BAR)

KG325
(20BAR)

KG228
(400BAR)

tutti i diritti riservati - all rights reserved

GUIDA RICAMBI - SPARE PARTS GUIDE

KIT RICAMBI

OGNI KIT SOTTO RIPORTATO COMPRENDE I RICAMBI EVIDENZIATI CON LO STESSO COLORE E LE RELATIVE GUARNIZIONI. QUESTI RICAMBI NON SONO FORNIBILI SEPARATAMENTE TRANNE QUELLI CODIFICATI.

SPARE PARTS KITS

EACH KIT SHOWN WITH THE SAME COLOR INCLUDES ALSO THE GASKETS. THE SPARE PARTS INCLUDED IN THE KIT CAN'T BE SUPPLIED SEPARATELY EXCEPT THOSE SHOWN WITH A PROPER CODE.

CODICE CODE	DESCRIZIONE DESCRIPTION	Q.TÀ QTY
KR8601	TAMPONE FERMATUBO HOSE STOP	1
KR8606	GRUPPO PERNO CENTRALE CENTRAL PIVOT KIT	1
KR8609	GRUPPO MOTORE IDRAULICO HYDRAULIC MOTOR KIT	1
KR8610	SET VITI ARROTOLATORE SET OF SCREWS HOSEREEL	1
KR8614	KIT PORTA RULLI ARROTOLATORE ROLLERS HOLDING KIT FOR HOSEREEL	1

ELENCO RICAMBI FORNIBILI SINGOLARMENTE

LIST OF SPARE PARTS WHICH CAN BE SUPPLIED SEPARATELY

CODICE CODE	DESCRIZIONE DESCRIPTION	Q.TÀ QTY
F860/R7035	DISTANZIALE MASCHIO MALE SPACER	1
F862/R7035	DISTANZIALE FEMMINA FEMALE SPACER	1
F863/R7035	FLANGIA LATO MOTORE MOTOR SIDE FLANGE	1
F864/R7035	STAFFA LATO TRAZIONE TRACTION SIDE BRACKET	1
F865/R7035	BASE ARROTOLATORE HOSEREEL BASE	1
F866/R7035	STAFFA LATO SNODO SWIVELLING BRACKET	1
F882/R7035	SUPPORTO MOTORE IDRAULICO HYDRAULIC MOTOR SUPPORT	1
F885/R7035	GANCIO SOLLEVAMENTO HOOK	2
G637/R7035	BRACCIO LATO SNODO JOINT SIDE BRACKET	2
KC500	TAMPONE FRENO STOPPER	1
KC503/R7035	FLANGIA LATO SNODO JOINT SIDE FLANGE	1
KG195	SNODO OLIO 150 BAR JOINT OIL 150 BAR	1
KG196	SNODO ACQUA 100 BAR JOINT WATER 100 BAR	1
KG214	SNODO ARIA-ACQUA 20 BAR JOINT AIR-WATER 20 BAR	1
KG228	SNODO ALTA PORTATA 1" 400 BAR JOINT HIGH DELIVERY 1" 400 BAR	1
KG233	MOTORE IDRAULICO HYDRAULIC MOTOR	1
S551	SUPPORTO CUSCINETTO BEARING SUPPORT	1

ELENCO GUARNIZIONI SNODI

JOINTS GASKETS LIST

CODICE CODE	DESCRIZIONE DESCRIPTION	Q.TÀ QTY
H160	O-RING 2093 O-RING 2093	1
H213	O-RING 2087 VITON O-RING 2087 VITON	1
H228	O-RING 4112 VITON O-RING 4112 VITON	1
H232	O-RING 2131 O-RING 2131	1
H233	GUARNIZIONE GASKET	1
H234	GUARNIZIONE DI 087 VITON GASKET	1
H261	RONDELLA IN PTFE PTFE WASHER	1
H356	O-RING 3106 VITON O-RING 3106 VITON	1
H370	O-RING 2062 VITON O-RING 2062 VITON	1
H396	RONDELLA IN PTFE PTFE WASHER	1
H397	RONDELLA IN PTFE PTFE WASHER	1
H398	RONDELLA IN PTFE PTFE WASHER	1
H399	GUARNIZIONE GASKET	1



Art. 8637.600 Mod. 637-10 bar



VISTA ESPLOSA - EXPLODED VIEW

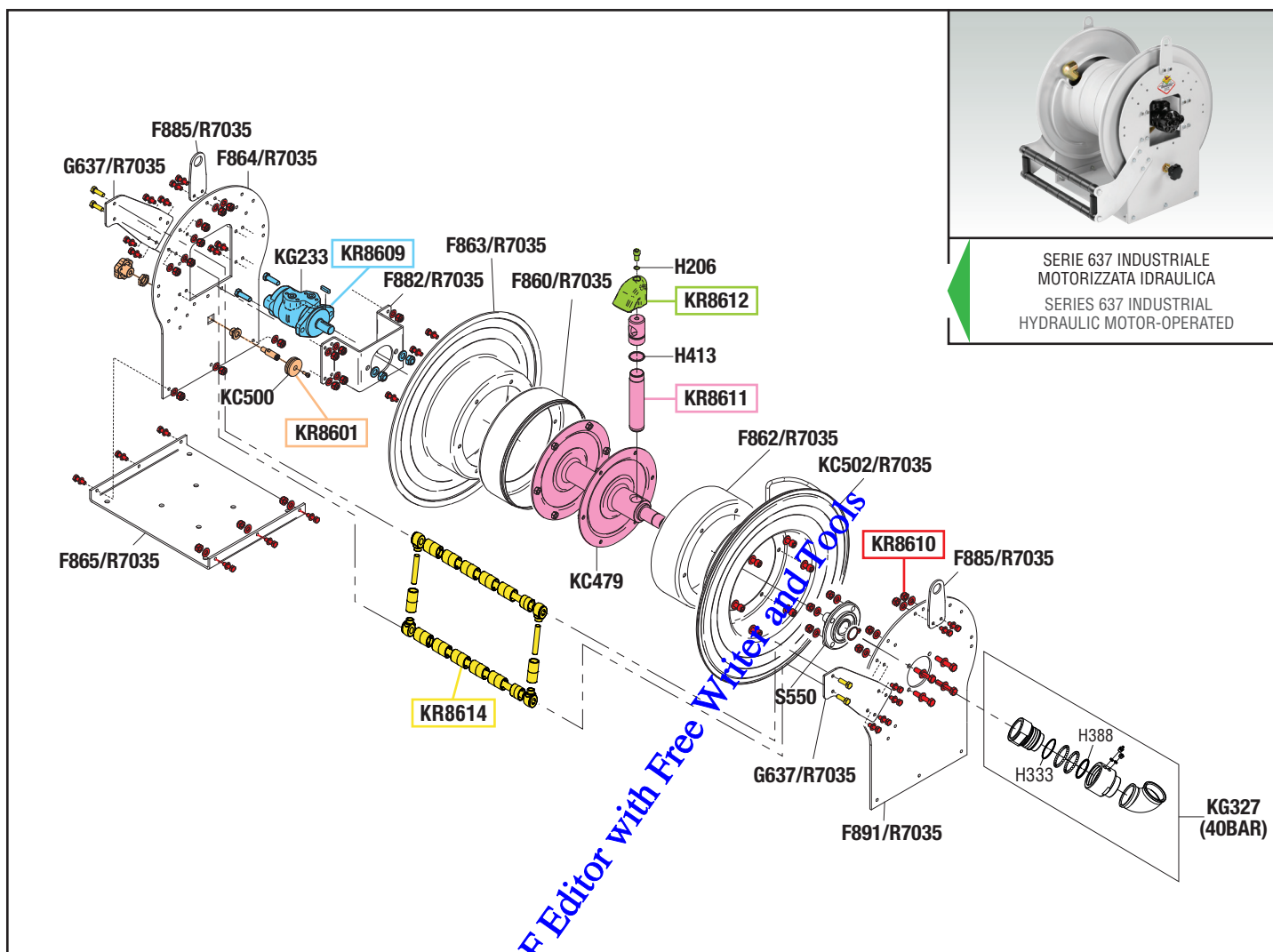

SERIE 637 INDUSTRIALE
MOTORIZZATA IDRAULICA
SERIES 637 INDUSTRIAL
HYDRAULIC MOTOR-OPERATED

GUIDA RICAMBI - SPARE PARTS GUIDE

KIT RICAMBI

OGNI KIT SOTTO RIPORTATO COMPRENDE I RICAMBI EVIDENZIATI CON LO STESSO COLORE E LE RELATIVE GUARNIZIONI. QUESTI RICAMBI NON SONO FORNIBILI SEPARATAMENTE TRANNE QUELLI CODIFICATI.

SPARE PARTS KITS

EACH KIT SHOWN WITH THE SAME COLOR INCLUDES ALSO THE GASKETS. THE SPARE PARTS INCLUDED IN THE KIT CAN'T BE SUPPLIED SEPARATELY EXCEPT THOSE SHOWN WITH A PROPER CODE.

CODICE CODE	DESCRIZIONE DESCRIPTION	Q.TÀ QTY
KR8601	KIT TAMPONE STOPPER KIT	1
KR8609	GRUPPO MOTORE IDRAULICO HYDRAULIC MOTOR KIT	1
KR8610	SET VITI ARROTOLATORE SET OF SCREWS HOSEREEL	1
KR8611	GRUPPO PERNO CENTRALE CENTRAL PIVOT KIT	1
KR8612	ATTACCO TUBO HOSE CONNECTION	1
KR8614	KIT PORTA RULLI ARROTOLATORE ROLLERS HOLDING KIT FOR HOSEREEL	1

ELENCO RICAMBI FORNIBILI SINGOLARMENTE

LIST OF SPARE PARTS WHICH CAN BE SUPPLIED SEPARATELY

CODICE CODE	DESCRIZIONE DESCRIPTION	Q.TÀ QTY
F860/R7035	DISTANZIALE MASCHIO MALE SPACER	1
F862/R7035	DISTANZIALE FEMMINA FEMALE SPACER	1
F863/R7035	FLANGIA LATO MOTORE MOTOR SIDE FLANGE	1
F864/R7035	STAFFA LATO TRAZIONE TRACTION SIDE BRACKET	1
F865/R7035	BASE ARROTOLATORE HOSEREEL BASE	1
F882/R7035	SUPPORTO MOTORE IDRAULICO HYDRAULIC MOTOR SUPPORT	1
F885/R7035	GANCIO SOLLEVAMENTO HOOK	2
F891/R7035	STAFFA LATO SNODO SWIVELLING BRACKET	1
G637/R7035	BRACCIO ORIENTABILE JOINT SIDE BRACKET	1
H206	O-RING 3043 "VITON" O-RING 3043 "VITON"	1
H413	O-RING 4150 "VITON" O-RING 4150 "VITON"	1
KC479	GRUPPO PERNO CENTRALE CENTRAL PIVOT GROUP	1
KC500	TAMPONE FRENO STOPPER	1
KC502/R7035	FLANGIA LATO SNODO JOINT SIDE FLANGE	1
KG233	MOTORE IDRAULICO HYDRAULIC MOTOR	1
KG327	SNODO ALTA PORTATA 1. 1/2" 40 BAR JOINT HIGH DELIVERY 1. 1/2" 40 BAR	1
S550	SUPPORTO CUSCINETTO BEARING SUPPORT	1

ELENCO GUARNIZIONI SNODI

JOINTS GASKETS LIST

CODICE CODE	DESCRIZIONE DESCRIPTION	Q.TÀ QTY
H333	O-RING 2093 O-RING 2093	1
H388	O-RING 3156 VITON O-RING 3156 VITON	1

tutti i diritti riservati - all rights reserved



Art. 8638.100 Mod. 638-20 bar - Art. 8638.200 Mod. 638-100 bar
Art. 8638.400 Mod. 638-150 bar - Art. 8638.500 Mod. 638-400 bar



VISTA ESPLOSA - EXPLODED VIEW

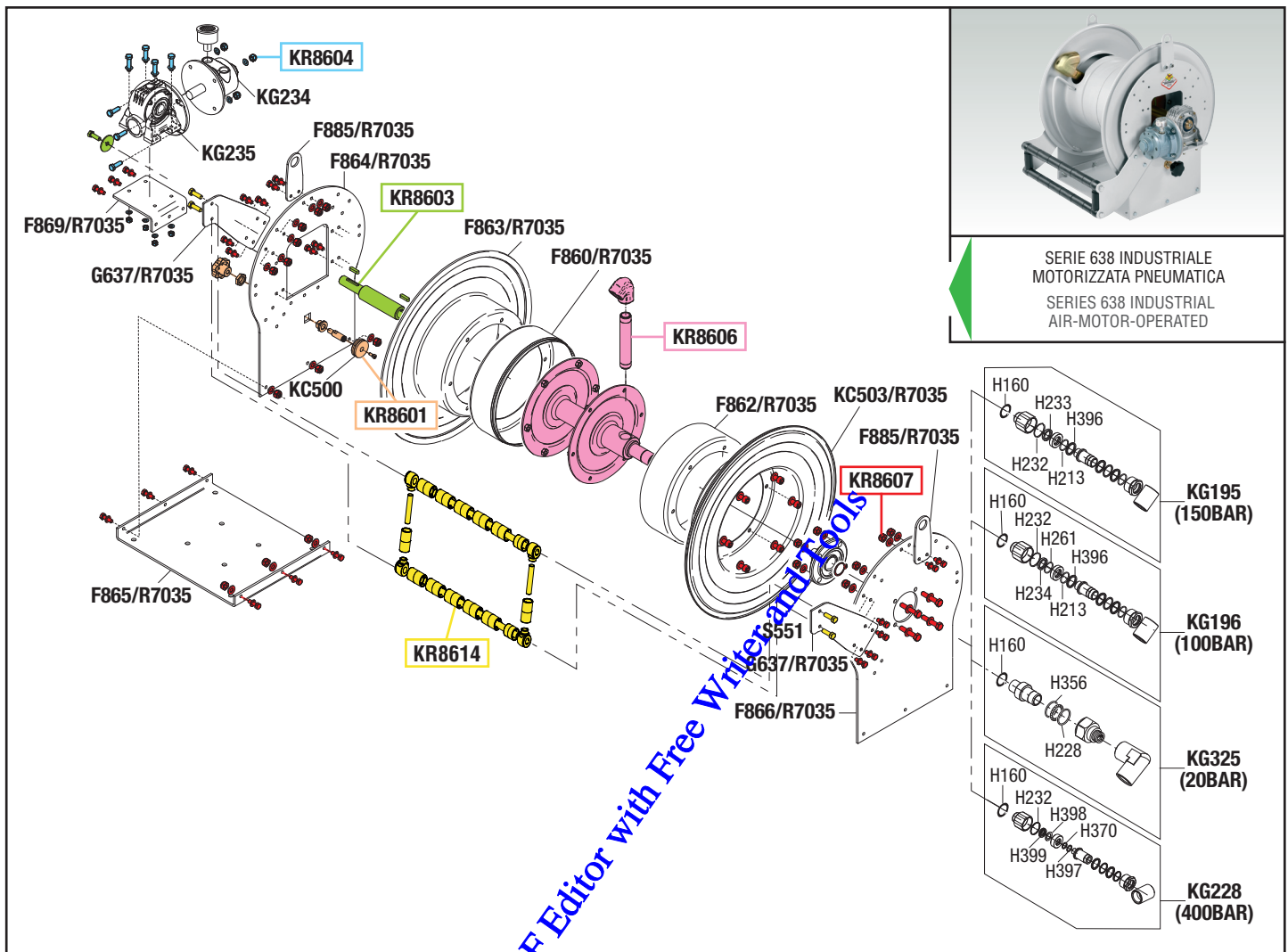

SERIE 638 INDUSTRIALE
MOTORIZZATA PNEUMATICA
SERIES 638 INDUSTRIAL
AIR-MOTOR-OPERATED

GUIDA RICAMBI - SPARE PARTS GUIDE

KIT RICAMBI

OGNI KIT SOTTO RIPORTATO COMPRENDE I RICAMBI EVIDENZIATI CON LO STESSO COLORE E LE RELATIVE GUARNIZIONI. QUESTI RICAMBI NON SONO FORNIBILI SEPARATAMENTE TRANNE QUELLI CODIFICATI.

SPARE PARTS KITS

EACH KIT SHOWN WITH THE SAME COLOR INCLUDES ALSO THE GASKETS. THE SPARE PARTS INCLUDED IN THE KIT CAN'T BE SUPPLIED SEPARATELY EXCEPT THOSE SHOWN WITH A PROPER CODE.

CODICE CODE	DESCRIZIONE DESCRIPTION	Q.TÀ QTY
KR8601	KIT TAMPONE STOPPER KIT	1
KR8603	ALBERO MOTORE MOTOR SHAFT	1
KR8604	SET VITI MOTORE SET OF MOTOR SCREWS	1
KR8606	GRUPPO PERNO CENTRALE CENTRAL PIVOT KIT	1
KR8607	SET VITI ARROTOLATORE SET OF SCREWS HOSEREEL	1
KR8614	KIT PORTA RULLI ARROTOLATORE ROLLERS HOLDING KIT FOR HOSEREEL	1

ELENCO RICAMBI FORNIBILI SINGOLARMENTE

LIST OF SPARE PARTS WHICH CAN BE SUPPLIED SEPARATELY

CODICE CODE	DESCRIZIONE DESCRIPTION	Q.TÀ QTY
F860/R7035	DISTANZIALE MASCHIO MALE SPACER	1
F862/R7035	DISTANZIALE FEMMINA FEMALE SPACER	1
F863/R7035	FLANGIA LATO MOTORE MOTOR SIDE FLANGE	1
F864/R7035	STAFFA LATO TRAZIONE TRACTION SIDE BRACKET	1
F865/R7035	BASE ARROTOLATORE HOSEREEL BASE	1
F866/R7035	STAFFA LATO SNODO SWIVELLING BRACKET	1
F869/R7035	SUPPORTO MOTORE MOTOR SUPPORT	1
F885/R7035	GANCIO SOLLEVAMENTO HOOK	2
G637/R7035	BRACCIO ORIENTABILE JOINT SIDE BRACKET	2
KC500	TAMPONE FRENO STOPPER	1
KC503/R7035	FLANGIA LATO SNODO JOINT SIDE FLANGE	1
KG195	SNODO OLIO 150 BAR JOINT OIL 150 BAR	1
KG196	SNODO ACQUA 100 BAR JOINT WATER 100 BAR	1
KG214	SNODO ARIA-ACQUA 20 BAR JOINT AIR-WATER 20 BAR	1
KG228	SNODO ALTA PORTATA 1" 400 BAR JOINT HIGH DELIVERY 1" 400 BAR	1
KG234	MOTORE PNEUMATICO PNEUMATIC MOTOR	1
KG235	RIDUTTORE REDUCTION GEAR	1
S551	SUPPORTO CUSCINETTO BEARING SUPPORT	1

ELENCO GUARNIZIONI SNODI

JOINTS GASKETS LIST

CODICE CODE	DESCRIZIONE DESCRIPTION	Q.TÀ QTY
H160	O-RING 2093 O-RING 2093	1
H213	O-RING 2087 VITON O-RING 2087 VITON	1
H228	O-RING 4112 VITON O-RING 4112 VITON	1
H232	O-RING 2131 O-RING 2131	1
H233	GUARNIZIONE GASKET	1
H234	GUARNIZIONE DI 087 VITON GASKET	1
H261	RONDELLA IN PTFE PTFE WASHER	1
H356	O-RING 3106 VITON O-RING 3106 VITON	1
H370	O-RING 2062 VITON O-RING 2062 VITON	1
H396	RONDELLA IN PTFE PTFE WASHER	1
H397	RONDELLA IN PTFE PTFE WASHER	1
H398	RONDELLA IN PTFE PTFE WASHER	1
H399	GUARNIZIONE GASKET	1

tutti i diritti riservati - all rights reserved



Art. 89010 MOD. 260 8X12-11m - Art. 89011 MOD. 260 6X10-11m

VISTA ESPLOSA - EXPLODED VIEW

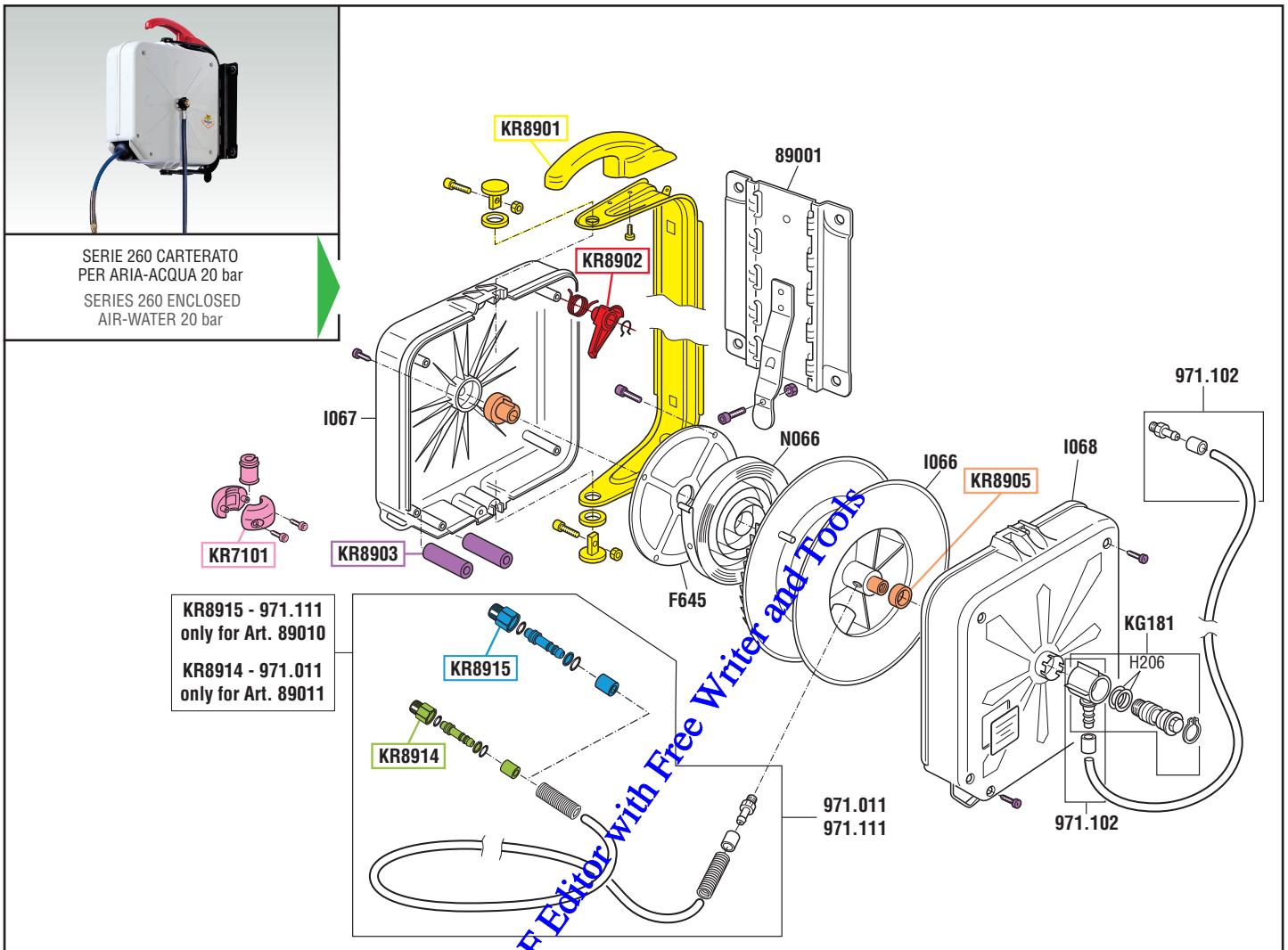

tutti i diritti riservati - all rights reserved

GUIDA RICAMBI - SPARE PARTS GUIDE

KIT RICAMBI
OGNI KIT SOTTO RIPORTATO COMPRENDE I RICAMBI EVIDENZIATI CON LO STESSO COLORE E LE RELATIVE GUARNIZIONI. QUESTI RICAMBI NON SONO FORNIBILI SEPARATAMENTE TRAMIE QUELLI CODIFICATI.

SPARE PARTS KITS
EACH KIT SHOWN WITH THE SAME COLOR INCLUDES ALSO THE GASKETS. THE SPARE PARTS INCLUDED IN THE KIT CAN'T BE SUPPLIED SEPARATELY EXCEPT THOSE SHOWN WITH A PROPER CODE.

CODICE CODE	DESCRIZIONE DESCRIPTION	Q.TÀ QTY
KR7101	TAMPONE FERMATUBO HOSE STOP	1
KR8901	SUPPORTO AVVOLGITUBO ORIENTABILE ADJUSTABLE BRACKET	1
KR8902	DENTE D'ARRESTO DETENT	1
KR8903	SET VITI AVVOLGITUBO HOSE REEL SCREWS KIT	1
KR8905	KIT BOCCOLE PERNO BUSH KIT PIN	1
KR8914	KIT SNODO POLIURETANO Ø 6X10 POLYURETHANE JOINT KITS Ø 6X10	1
KR8915	KIT SNODO POLIURETANO Ø 8X12 POLYURETHANE JOINT KITS Ø 8X12	1

ELENCO RICAMBI FORNIBILI SINGOLARMENTE
LIST OF SPARE PARTS WHICH CAN BE SUPPLIED SEPARATELY

CODICE CODE	DESCRIZIONE DESCRIPTION	Q.TÀ QTY
89001	STAFFA MURALE WALL BRACKET	1
F645	CARTER COVER	1
H206	O-RING 3043 "VITON" O-RING 3043 "VITON"	2
I066	TAMBURO DRUM	1
I067	CARTER COVER	1
I068	CARTER COVER	1
971.011	TUBO IN "POLIURETANO" 6 x 10 - 11m (Art. 89011) "POLYURETHANE" HOSE 6 x 10 - 11m (Art. 89011)	1
971.111	TUBO "POLIURETANO" 8 x 12 - 11 m (Art. 89010) "POLYURETHANE" HOSE 8 x 12 - 11 m (Art. 89010)	1
971.102	SPEZZONE TUBO 1,5m HOSE SECTION 1,5m	1
KG181	SNODO AVVOLGITUBO HOSE REEL JOINT	1
N066	MOLLA DI CARICA SPRING	1



Art. 89109 MOD. 261-8X12-11m Art. 89110 MOD. 261-6X10-11m



VISTA ESPLOSA - EXPLODED VIEW

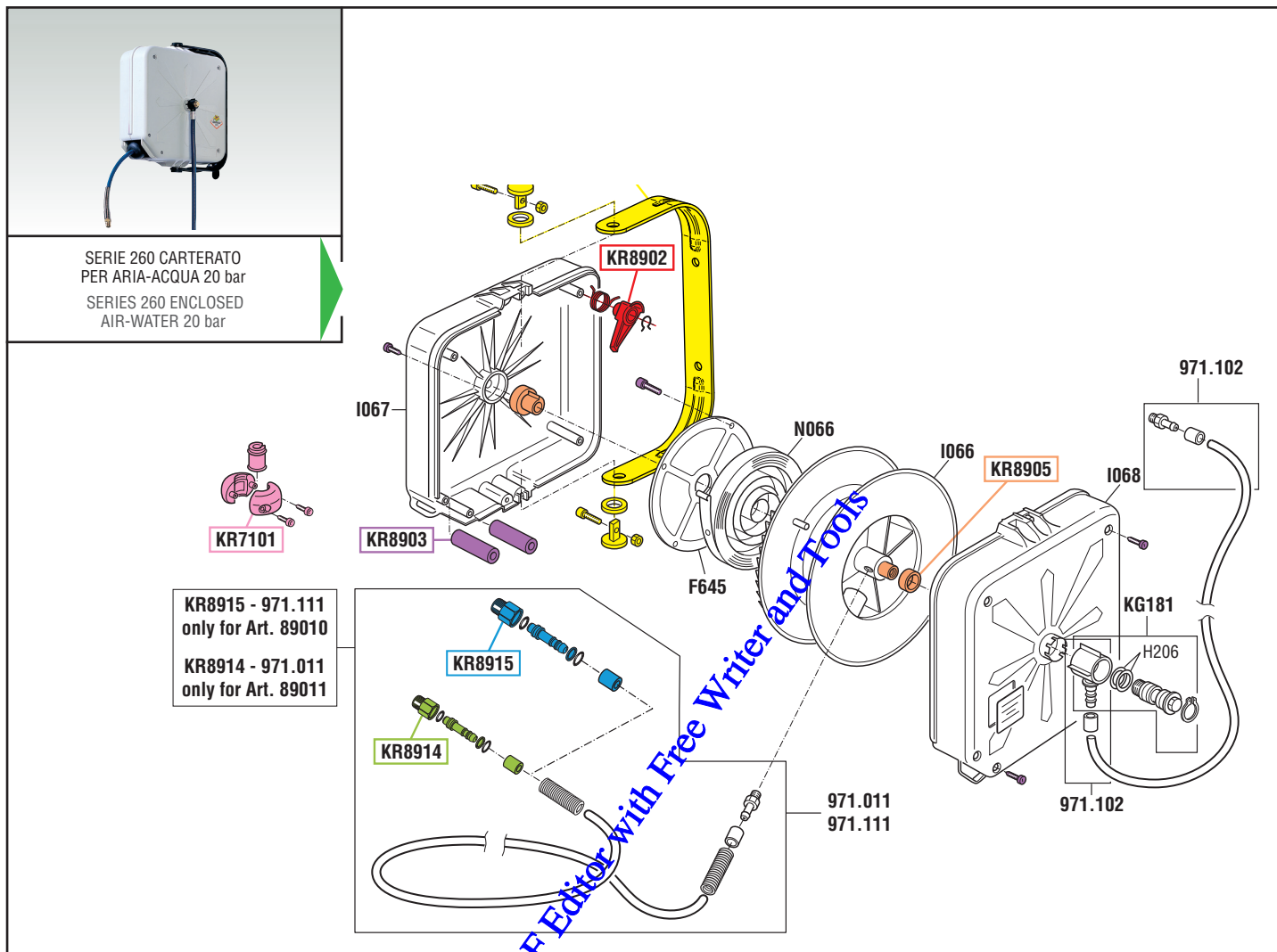

tutti i diritti riservati - all rights reserved

GUIDA RICAMBI - SPARE PARTS GUIDE

KIT RICAMBI

OGNI KIT SOTTO RIPORTATO COMPRENDE I RICAMBI EVIDENZIATI CON LO STESSO COLORE E LE RELATIVE GUARNIZIONI. QUESTI RICAMBI NON SONO FORNIBILI SEPARATAMENTE TRAMITE QUELLI CODIFICATI.

SPARE PARTS KITS

EACH KIT SHOWN WITH THE SAME COLOR INCLUDES ALSO THE GASKETS. THE SPARE PARTS INCLUDED IN THE KIT CAN'T BE SUPPLIED SEPARATELY EXCEPT THOSE SHOWN WITH A PROPER CODE.

CODICE CODE	DESCRIZIONE DESCRIPTION	Q.TÀ QTY
KR7101	TAMPONE FERMATUBO HOSE STOP	1
KR8902	DENTE D'ARRESTO DETENT	1
KR8903	SET VITI AVVOLGITUBO HOSE REEL SCREWS KIT	1
KR8905	KIT BOCCOLE PERNO BUSH PIN KIT	1
KR8912	SUPPORTO AVVOLGITUBO ORIENTABILE ADJUSTABLE BRACKET	1
KR8914	KIT SNODO POLIURETANO Ø 6X10 POLYURETHANE JOINT KITS Ø 6X10	1
KR8915	KIT SNODO POLIURETANO Ø 8X12 POLYURETHANE JOINT KITS Ø 8X12	1

ELENCO RICAMBI FORNIBILI SINGOLARMENTE

LIST OF SPARE PARTS WHICH CAN BE SUPPLIED SEPARATELY

CODICE CODE	DESCRIZIONE DESCRIPTION	Q.TÀ QTY
F645	CARTER COVER	1
H206	O-RING 3043 "VITON" O-RING 3043 "VITON"	2
I066	TAMBURNO DRUM	1
I067	CARTER COVER	1
I068	CARTER COVER	1
971.011	TUBO "POLIURETANO" 6 x 10 - 11m (Art. 89110) "POLYURETHANE" HOSE 6 x 10 - 11m (Art. 89110)	1
971.111	TUBO "POLIURETANO" 8 x 12 - 11 m (Art. 89109) "POLYURETHANE" HOSE 8 x 12 - 11 m (Art. 89109)	1
971.102	SPEZZONE TUBO 1,5m HOSE SECTION 1,5m	1
KG181	SNODO AVVOLGITUBO HOSE REEL JOINT	1
N066	MOLLA DI CARICA SPRING	1



Art. 90C/111 Mod. 900C-11100 - Art. 91C/111 Mod. 900C-11194
Art. 92C/111 Mod. 900C-11174



VISTA ESPLOSA - EXPLODED VIEW

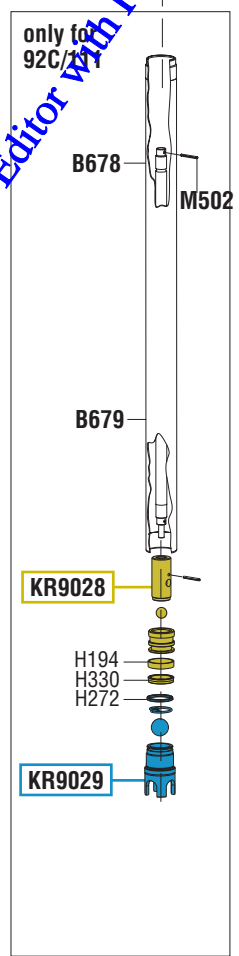
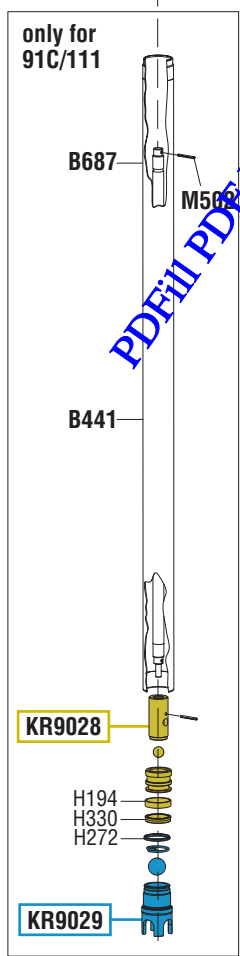
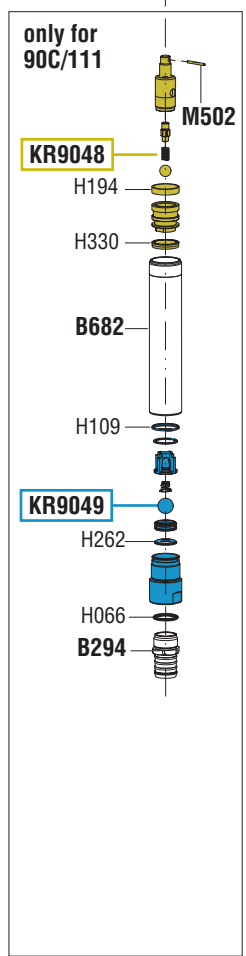
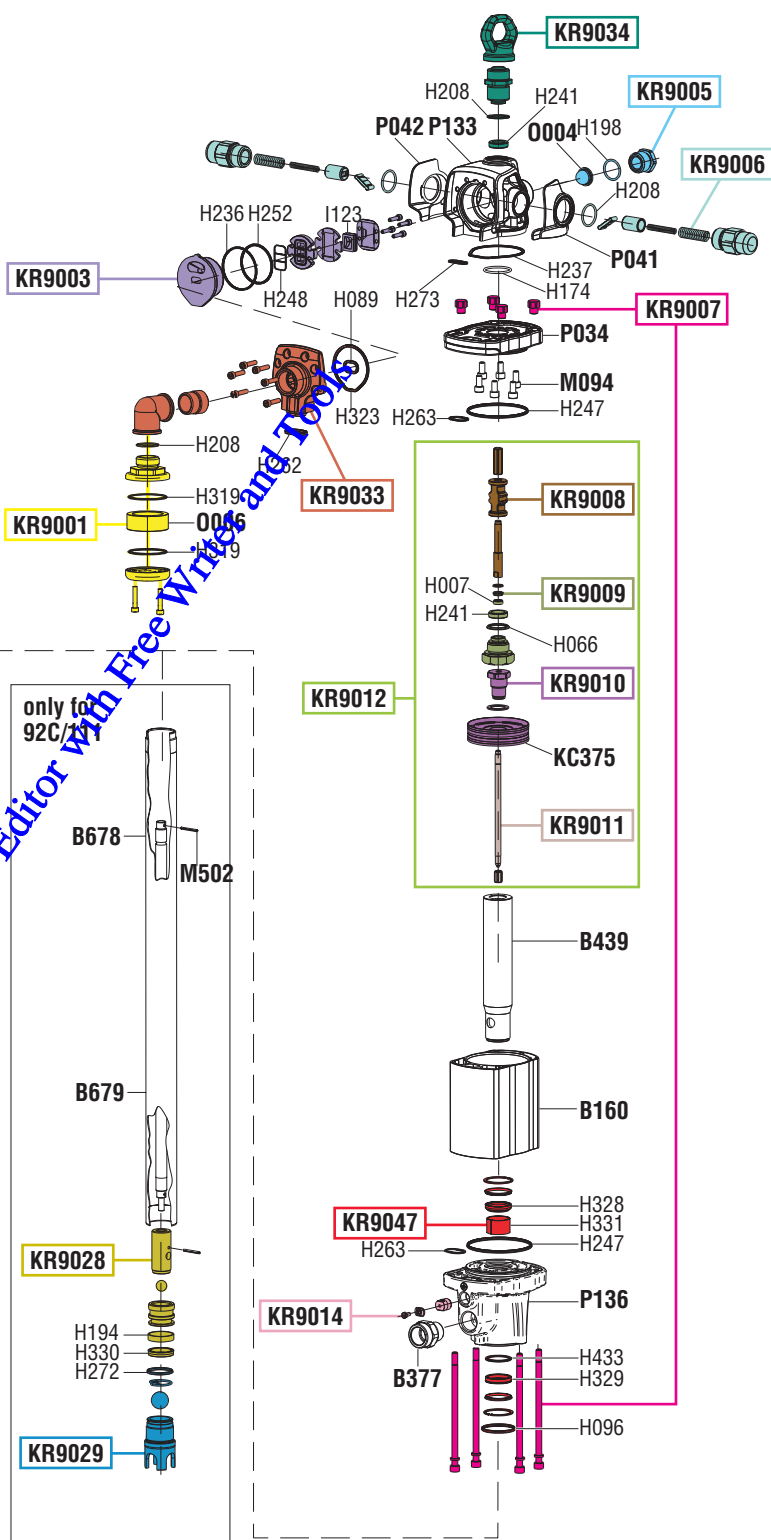

PDFfill PDF Editor With Free Watermark Remover

tutti i diritti riservati - all rights reserved

GUIDA RICAMBI - SPARE PARTS GUIDE

KIT RICAMBI OGNI KIT SOTTO RIPORTATO COMPRENDE I RICAMBI EVIDENZIATI CON LO STESSO COLORE E LE RELATIVE GUARNIZIONI. QUESTI RICAMBI NON SONO FORNIBILI SEPARATAMENTE TRANNE QUELLI CODIFICATI.		
SPARE PARTS KITS EACH KIT SHOWN WITH THE SAME COLOR INCLUDES ALSO THE GASKETS. THE SPARE PARTS INCLUDED IN THE KIT CAN'T BE SUPPLIED SEPARATELY EXCEPT THOSE SHOWN WITH A PROPER CODE.		
CODICE CODE	DESCRIZIONE DESCRIPTION	Q.TÀ QTY
KR9001	SILENZIATORE MUFFLER	1
KR9003	GRUPPO DISTRIBUTORE D'ARIA SLIDE VALVE GROUP	1
KR9005	RIDUZIONE ENTRATA AIR INLET CONNECTION	1
KR9006	BOSSOLI INVERTITORE BUSHES	1
KR9007	PRIGIONIERI STUD BOLTS	1
KR9008	GRUPPO INVERTITORE PLUNGER GROUP	1
KR9009	TAPPO SUPERIORE UPPER PLUG	1
KR9010	PISTONE MOTORE AIR PISTON	1
KR9011	ASTA INVERTITORE ROD	1
KR9012	GRUPPO DISTRIBUZIONE DISTRIBUTION GROUP	1
KR9014	MESSA A TERRA GROUNDED	1
KR9028	PISTONE POMPANTE PUMPING PISTON	1
KR9029	VALVOLA DI FONDO BOTTOM VALVE	1
KR9033	COLLETTORE DI SCARICO DISCHARGE CONNECTION	1
KR9034	GOLFARDO CON BOSSOLO GUIDA STELO BUSH	1
KR9047	GRUPPO TENUTA INFERIORE LOWER SEAL GROUP	1
KR9048	PISTONE POMPANTE (Art. 90C/111) PUMPING PISTON (Art. 90C/111)	1
KR9049	VALVOLA DI FONDO (Art. 90C/111) BOTTOM VALVE (Art. 90C/111)	1

ELENCO RICAMBI FORNIBILI SINGOLARMENTE LIST OF SPARE PARTS WHICH CAN BE SUPPLIED SEPARATELY		
CODICE CODE	DESCRIZIONE DESCRIPTION	Q.TÀ QTY
B160	CILINDRO MOTORE MOTOR CYLINDER	1
B294	PORTA TUBO HOSE CONNECTION	1
B377	BOCCHETTONE USCITA LIQUID OUTLET	1
B439	STELO MOTORE ROD	1
B441	TUBO PESCANTE (91C/111) SUCTION TUBE (91C/111)	1
B678	STELO POMPANTE (92C/111) PUMPING ROD (92C/111)	1
B679	TUBO PESCANTE (92C/111) SUCTION TUBE (92C/111)	1
B682	TUBO PESCANTE (90C/111) SUCTION TUBE (90C/111)	1
B687	STELO POMPANTE (91C/111) PUMPING ROD (91C/111)	1
KC375	PISTONE MOTORE PISTON	1
M094	VITE M8x20 SCREW M8x20	6
M502	SPINA ELASTICA PIN	1
0004	FILTRO ARIA AIR FILTER	1
0006	SILENZIATORE MUFFLER	1
P034	PIASTRA SUPERIORE UPPER FLANGE	1
P041	GUANCIA SINISTRA LEFT COVER	1
P042	GUANCIA DESTRA RIGHT COVER	1
P133	CORPO SUPERIORE UPPER BODY	1
P136	CORPO INFERIORE LOWER BODY	1

KIT GUARNIZIONI COMPLETI TUTTE LE GUARNIZIONI (H...) MENZIONATE NELL'ESPLOSO SONO FORNIBILI ANCHE SINGOLARMENTE		
COMPLETE GASKETS KIT ALL THE O-RING (H...) MENTIONED IN THE EXPLODED VIEW CAN BE SUPPLIED SEPARATELY		
CODICE CODE	DESCRIZIONE DESCRIPTION	Q.TÀ QTY
KR9050	KIT GUARNIZIONI MOTORE SUPERIORE GASKETS KIT FOR UPPER MOTOR	1
KR9055	KIT GUARNIZIONI PISTONE ø 90 GASKETS KIT FOR PISTON ø 90	1
KR9060	KIT GUARNIZIONI PESCANTE (91C/111-92C/111) GASKETS KIT FOR SUCTION TUBE	1
KR9067	KIT GUARNIZIONI MOTORE INFERIORE GASKETS KIT FOR LOWER MOTOR	1
KR9068	KIT GUARNIZIONI PESCANTE (90C/111) GASKETS KIT FOR SUCTION TUBE	1

Art. KS9194 SET RICAMBI CONSIGLIATI AI PUNTI VENDITA E ASSISTENZA, COMPOSTO DAI RICAMBI SOTTO ELENCATI. SPARE PARTS KIT ADVISED TO THE SELLING CENTERS, THIS KIT INCLUDES ALL THE SPARE PARTS SHOWN HERE UNDER.		
CODICE CODE	DESCRIZIONE DESCRIPTION	Q.TÀ QTY
KR9003	GRUPPO DISTRIBUZIONE ARIA SLIDE VALVE GROUP	1
KR9050	KIT GUARNIZIONI MOTORE SUPERIORE GASKETS KIT FOR UPPER MOTOR	1
KR9055	KIT GUARNIZIONI PISTONE ø 90 GASKETS KIT FOR PISTON ø 90	1
KR9060	KIT GUARNIZIONI PESCANTE (91C/111-92C/111) GASKETS KIT FOR SUCTION TUBE	1
KR9067	KIT GUARNIZIONI MOTORE INFERIORE GASKETS KIT FOR LOWER MOTOR	1
KR9068	KIT GUARNIZIONI PESCANTE (90C/111) GASKETS KIT FOR SUCTION TUBE	1

PDFfill PDF Editor with Free Writer and Tools



Art. 90C/51 Mod. 900C-5100



VISTA ESPLOSA - EXPLODED VIEW



POMPA INTEGRALE S. 900
R. 5:1 - 45 l/min
INTEGRAL PUMP S. 900
R. 5:1 - 45 l/min

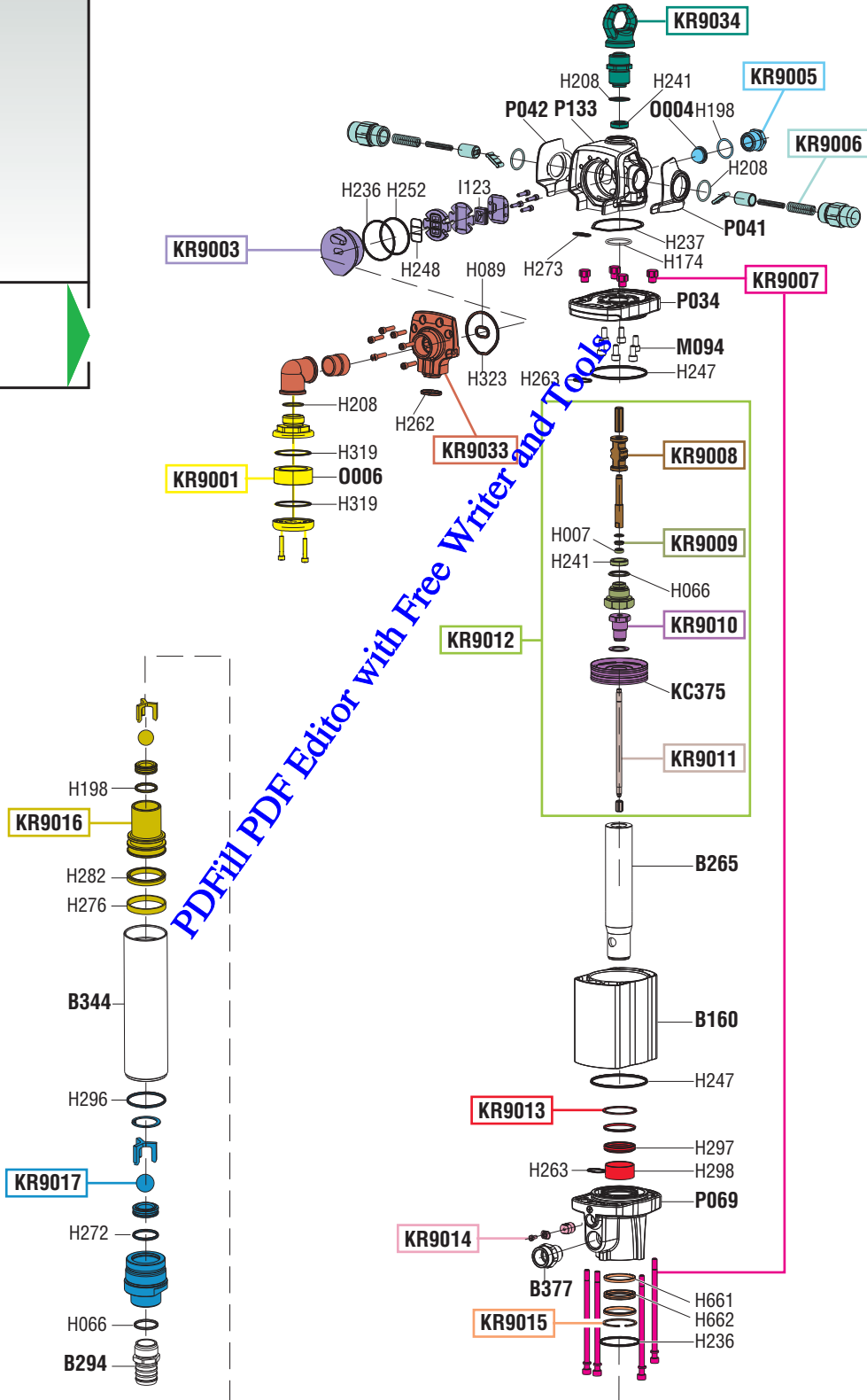

tutti i diritti riservati - all rights reserved

GUIDA RICAMBI - SPARE PARTS GUIDE

KIT RICAMBI

OGNI KIT SOTTO RIPORTATO COMPRENDE I RICAMBI EVIDENZIATI CON LO STESSO COLORE E LE RELATIVE GUARNIZIONI. QUESTI RICAMBI NON SONO FORNIBILI SEPARATAMENTE TRANNE QUELLI CODIFICATI.

SPARE PARTS KITS

EACH KIT SHOWN WITH THE SAME COLOR INCLUDES ALSO THE GASKETS. THE SPARE PARTS INCLUDED IN THE KIT CAN'T BE SUPPLIED SEPARATELY EXCEPT THOSE SHOWN WITH A PROPER CODE.

CODICE CODE	DESCRIZIONE DESCRIPTION	Q.TÀ QTY
KR9001	SILENZIATORE MUFFLER	1
KR9003	GRUPPO DISTRIBUTORE D'ARIA SLIDE VALVE GROUP	1
KR9005	RIDUZIONE ENTRATA AIR INLET CONNECTION	1
KR9006	BOSSOLI INVERTITORE BUSHES	1
KR9007	PRIGIONIERI STUD BOLTS	1
KR9008	GRUPPO INVERTITORE PLUNGER GROUP	1
KR9009	TAPPO SUPERIORE UPPER PLUG	1
KR9010	PISTONE MOTORE AIR PISTON	1
KR9011	ASTA INVERTITORE ROD	1
KR9012	GRUPPO DISTRIBUZIONE DISTRIBUTION GROUP	1
KR9013	GRUPPO TENUTA SUPERIORE UPPER SEAL GROUP	1
KR9014	MESSA A TERRA GROUNDED	1
KR9015	GRUPPO TENUTA INFERIORE LOWER SEAL GROUP	1
KR9016	PISTONE POMPANTE PUMPING PISTON	1
KR9017	VALVOLA DI FONDO BOTTOM VALVE	1
KR9033	COLLETTORE DI SCARICO DISCHARGE CONNECTION	1
KR9034	GOLFARO CON BOSSOLO GUIDA STELO BUSH	1

ELENCO RICAMBI FORNIBILI SINGOLARMENTE
LIST OF SPARE PARTS WHICH CAN BE SUPPLIED SEPARATELY

CODICE CODE	DESCRIZIONE DESCRIPTION	Q.TÀ QTY
B160	CILINDRO MOTORE MOTOR CYLINDER	1
B265	STELO POMPANTE ROD	1
B294	PORTA TUBO HOSE CONNECTION	1
B344	TUBO PESCANTE SUCTION TUBE	1
B377	BOCCHETTONE USCITA LIQUID OUTLET	1
KC375	PISTONE MOTORE PISTON	1
M094	VITE M8x20 SCREW M8x20	6
0004	FILTRO ARIA AIR FILTER	1
0006	SILENZIATORE MUFFLER	1
P034	PIASTRA SUPERIORE UPPER FLANGE	1
P041	GUANCIA SINISTRA LEFT COVER	1
P042	GUANCIA DESTRA RIGHT COVER	1
P069	CORPO INFERIORE LOWER BODY	1
P133	CORPO SUPERIORE UPPER BODY	1

KIT GUARNIZIONI COMPLETI

TUTTE LE GUARNIZIONI (H...) MENZIONATE NELL'ESPLOSO SONO FORNIBILI ANCHE SINGOLARMENTE

COMPLETE GASKETS KIT

ALL THE O-RING (H...) MENTIONED IN THE EXPLODED VIEW CAN BE SUPPLIED SEPARATELY

CODICE CODE	DESCRIZIONE DESCRIPTION	Q.TÀ QTY
KR9050	KIT GUARNIZIONI MOTORE SUPERIORE GASKETS KIT FOR UPPER MOTOR	
KR9051	KIT GUARNIZIONI MOTORE INFERIORE GASKETS KIT FOR LOWER MOTOR	
KR9052	KIT GUARNIZIONI PESCANTE GASKETS KIT FOR SUCTION TUBE	
KR9055	KIT GUARNIZIONI PISTONE ø 90 GASKETS KIT FOR PISTON ø 90	

Art.
KS9080**SET RICAMBI CONSIGLIATI**

AI PUNTI VENDITA E ASSISTENZA, COMPOSTO DAI RICAMBI SOTTO ELENCATI.

SPARE PARTS KIT ADVISED

TO THE SELLING CENTERS. THIS KIT INCLUDES ALL THE SPARE PARTS SHOWN HERE UNDER.

CODICE CODE	DESCRIZIONE DESCRIPTION	Q.TÀ QTY
KR9003	GRUPPO DISTRIBUZIONE ARIA SLIDE VALVE GROUP	1
KR9050	KIT GUARNIZIONI MOTORE SUPERIORE GASKETS KIT FOR UPPER MOTOR	1
KR9051	KIT GUARNIZIONI MOTORE INFERIORE GASKETS KIT FOR LOWER MOTOR	1
KR9052	KIT GUARNIZIONI PESCANTE GASKETS KIT FOR SUCTION TUBE	1
KR9055	KIT GUARNIZIONI PISTONE ø 90 GASKETS KIT FOR PISTON ø 90	1

PDFill PDF Editor with Free Writer and Tools



Art. 90C/71 Mod. 900C-7100 - Art. 91C/71 Mod. 900C-7194
Art. 92C/71 Mod. 900C-71126 - Art. 93C/71 Mod. 900C-7174



VISTA ESPLOSA - EXPLODED VIEW

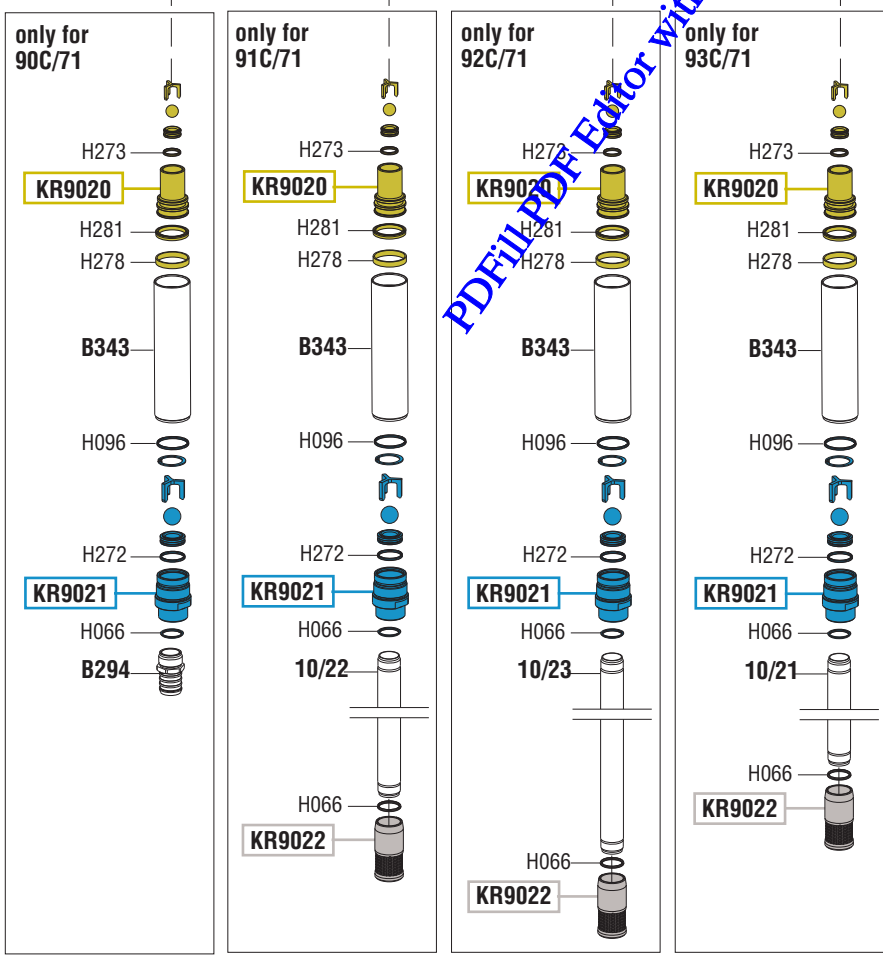
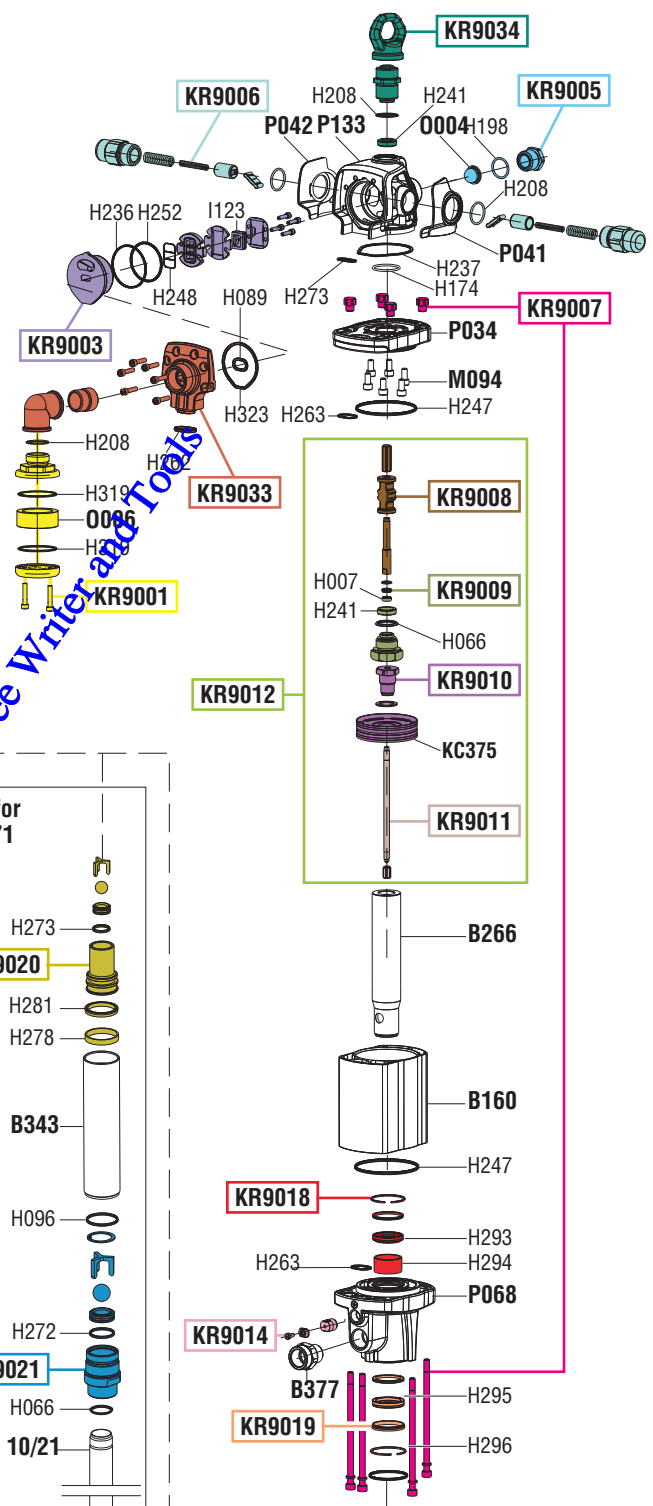

PDFFill PDF Editor with Free Writer and Tools

tutti i diritti riservati - all rights reserved

GUIDA RICAMBI - SPARE PARTS GUIDE

KIT RICAMBI OGNI KIT SOTTO RIPORTATO COMPRENDE I RICAMBI EVIDENZIATI CON LO STESSO COLORE E LE RELATIVE GUARNIZIONI. QUESTI RICAMBI NON SONO FORNIBILI SEPARATAMENTE TRANNE QUELLI CODIFICATI.		
SPARE PARTS KITS EACH KIT SHOWN WITH THE SAME COLOR INCLUDES ALSO THE GASKETS. THE SPARE PARTS INCLUDED IN THE KIT CAN'T BE SUPPLIED SEPARATELY EXCEPT THOSE SHOWN WITH A PROPER CODE.		
CODICE CODE	DESCRIZIONE DESCRIPTION	Q.TÀ QTY
KR9001	SILENZIATORE MUFFLER	1
KR9003	GRUPPO DISTRIBUTORE D'ARIA SLIDE VALVE GROUP	1
KR9005	RIDUZIONE ENTRATA AIR INLET CONNECTION	1
KR9006	BOSSOLI INVERTITORE BUSHES	1
KR9007	PRIGIONIERI STUD BOLTS	1
KR9008	GRUPPO INVERTITORE PLUNGER GROUP	1
KR9009	TAPPO SUPERIORE UPPER PLUG	1
KR9010	PISTONE MOTORE AIR PISTON	1
KR9011	ASTA INVERTITORE ROD	1
KR9012	GRUPPO DISTRIBUZIONE DISTRIBUTION GROUP	1
KR9014	MESSA A TERRA GROUNDED	1
KR9018	GRUPPO TENUTA SUPERIORE LOWER SEAL GROUP	1
KR9019	GRUPPO TENUTA INFERIORE LOWER SEAL GROUP	1
KR9020	PISTONE POMPANTE PUMPING PISTON	1
KR9021	VALVOLA DI FONDO BOTTOM VALVE	1
KR9022	FILTRO PESCANTE (Art. 92C/71) SHANK FILTER (Art. 92C/71)	1
KR9033	COLLETTORE DI SCARICO DISCHARGE CONNECTION	1
KR9034	GOLFARO CON BOSSOLO GUIDA STELO BUSH	1

ELENCO RICAMBI FORNIBILI SINGOLARMENTE LIST OF SPARE PARTS WHICH CAN BE SUPPLIED SEPARATELY		
CODICE CODE	DESCRIZIONE DESCRIPTION	Q.TÀ QTY
10/21	PROLUNGA PESCANTE (Art.93C/71) SUCTION TUBE EXTENSION (Art. 93C/71)	1
10/22	PROLUNGA PESCANTE (Art.91C/71) SUCTION TUBE EXTENSION (Art. 91C/71)	1
10/23	PROLUNGA PESCANTE (Art. 92C/71) SUCTION TUBE EXTENSION (Art.92C/71)	1
B160	CILINDRO MOTORE MOTOR CYLINDER	1
B266	STELO POMPANTE ROD	1
B294	PORTA TUBO (Art. 90C/71) HOSE CONNECTION (Art. 90C/71)	1
B343	TUBO PESCANTE SUCTION TUBE	1
B377	BOCCHETTONE USCITA LIQUID OUTLET	1
KC375	PISTONE MOTORE PISTON	1
M094	VITE M8x20 SCREW M8x20	6
0004	FILTRO ARIA AIR FILTER	1
0006	SILENZIATORE MUFFLER	1
P034	PIASTRA SUPERIORE UPPER FLANGE	1
P041	GUANCIA SINISTRA LEFT COVER	1
P042	GUANCIA DESTRA RIGHT COVER	1
P068	CORPO INFERIORE LOWER BODY	1
P133	CORPO SUPERIORE UPPER BODY	1

KIT GUARNIZIONI COMPLETI TUTTE LE GUARNIZIONI (H...) MENZIONATE NELL'ESPLOSO SONO FORNIBILI ANCHE SINGOLARMENTE		
COMPLETE GASKETS KIT ALL THE O-RING (H...) MENTIONED IN THE EXPLODED VIEW CAN BE SUPPLIED SEPARATELY		
CODICE CODE	DESCRIZIONE DESCRIPTION	Q.TÀ QTY
KR9050	KIT GUARNIZIONI MOTORE SUPERIORE GASKETS KIT FOR UPPER MOTOR	1
KR9053	KIT GUARNIZIONI MOTORE INFERIORE GASKETS KIT FOR LOWER MOTOR	1
KR9054	KIT GUARNIZIONI PESCANTE GASKETS KIT FOR SUCTION TUBE	1
KR9055	KIT GUARNIZIONI PISTONE ø 90 GASKETS KIT FOR PISTON ø 90	1

Art. KS9081 SET RICAMBI CONSIGLIATI AI PUNTI VENDITA E ASSISTENZA, COMPOSTO DAI RICAMBI SOTTO ELENCATI. SPARE PARTS KIT ADVISED TO THE SELLING CENTERS, THIS KIT INCLUDES ALL THE SPARE PARTS SHOWN HERE UNDER.		
CODICE CODE	DESCRIZIONE DESCRIPTION	Q.TÀ QTY
KR9003	GRUPPO DISTRIBUZIONE ARIA SLIDE VALVE GROUP	1
KR9050	KIT GUARNIZIONI MOTORE SUPERIORE GASKETS KIT FOR UPPER MOTOR	1
KR9053	KIT GUARNIZIONI MOTORE INFERIORE GASKETS KIT FOR LOWER MOTOR	1
KR9054	KIT GUARNIZIONI PESCANTE GASKETS KIT FOR SUCTION TUBE	1
KR9055	KIT GUARNIZIONI PISTONE ø 90 GASKETS KIT FOR PISTON ø 90	1

PDFfill PDF Editor with Free Writer and Tools



Art. 90D/111 Mod. 900D-11100



VISTA ESPLOSA - EXPLODED VIEW



POMPA DISSOCIATA S. 900
R. 11:1 - 30 l/min
DIVORCED PUMP S. 900
R 11:1 - 30 l/min

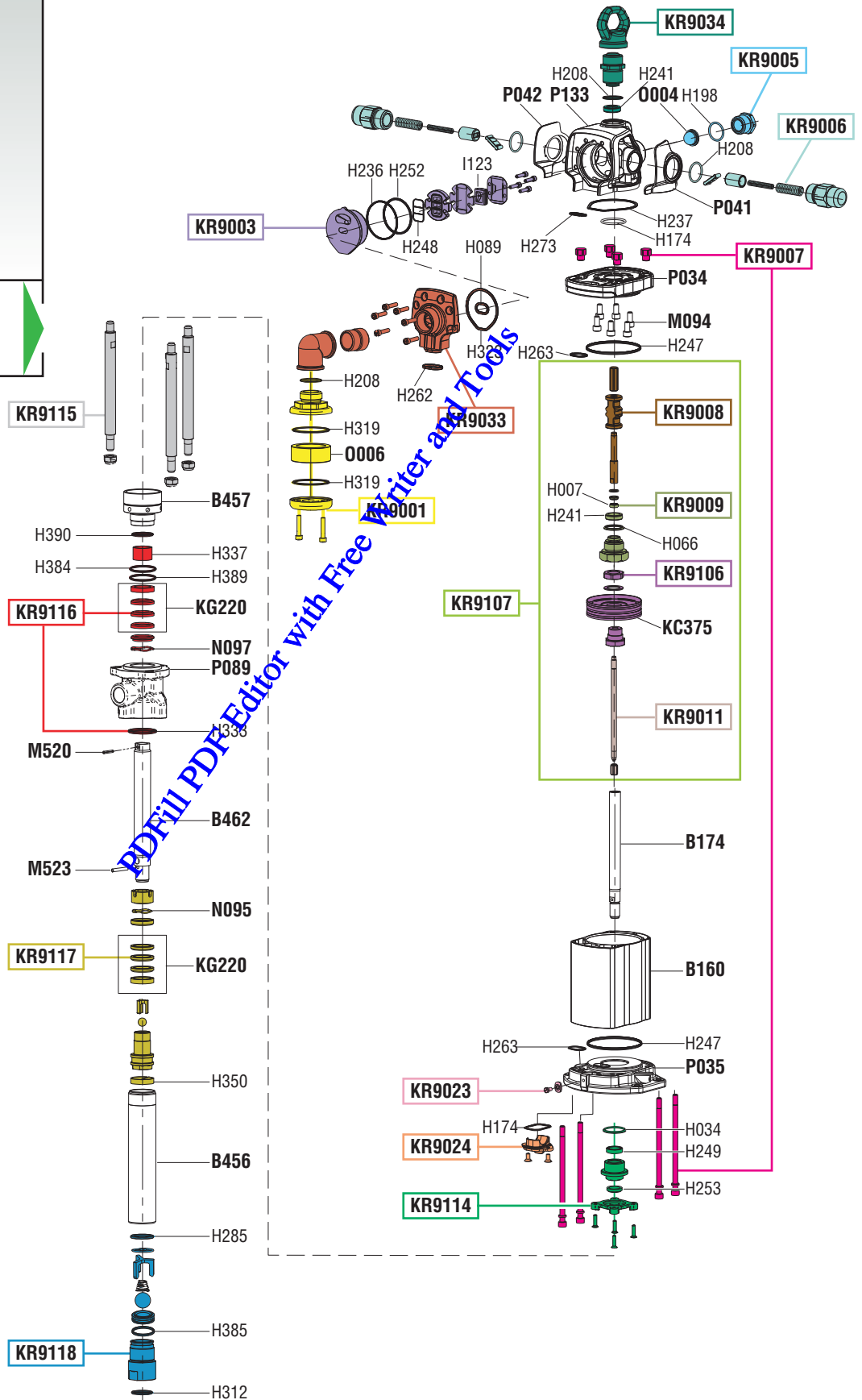

PDFFill PDF Editor with Free Writer and Tools

tutti i diritti riservati - all rights reserved

GUIDA RICAMBI - SPARE PARTS GUIDE

KIT RICAMBI OGNI KIT SOTTO RIPORTATO COMPRENDE I RICAMBI EVIDENZIATI CON LO STESSO COLORE E LE RELATIVE GUARNIZIONI. QUESTI RICAMBI NON SONO FORNIBILI SEPARATAMENTE TRANNE QUELLI CODIFICATI.		
SPARE PARTS KITS EACH KIT SHOWN WITH THE SAME COLOR INCLUDES ALSO THE GASKETS. THE SPARE PARTS INCLUDED IN THE KIT CAN'T BE SUPPLIED SEPARATELY EXCEPT THOSE SHOWN WITH A PROPER CODE.		
CODICE CODE	DESCRIZIONE DESCRIPTION	Q.TÀ QTY
KR9001	SILENZIATORE MUFFLER	1
KR9003	GRUPPO DISTRIBUTORE D'ARIA SLIDE VALVE GROUP	1
KR9005	RIDUZIONE ENTRATA AIR INLET CONNECTION	1
KR9006	BOSSOLI INVERTITORE BUSHES	1
KR9007	PRIGIONIERI STUD BOLTS	1
KR9008	GRUPPO INVERTITORE PLUNGER GROUP	1
KR9009	TAPPO SUPERIORE UPPER PLUG	1
KR9011	ASTA INVERTITORE ROD	1
KR9023	MESSA A TERRA GROUNDED	1
KR9024	COLLETTORE MANIFOLD	1
KR9033	COLLETTORE DI SCARICO DISCHARGE CONNECTION	1
KR9034	GOLFARO CON BOSSOLO GUIDA STELO BUSH	1
KR9106	PISTONE MOTORE AIR PISTON	1
KR9107	GRUPPO DISTRIBUZIONE DISTRIBUTION GROUP	1
KR9114	GRUPPO TENUTA INFERIORE LOWER SEAL GROUP	1
KR9115	PRIGIONIERI STUD BOLTS	1
KR9116	GRUPPO TENUTA INFERIORE LOWER SEAL GROUP	1
KR9117	PISTONE POMPANTE PUMPING PISTON	1
KR9118	VALVOLA DI FONDO BOTTOM VALVE	1

ELENCO RICAMBI FORNIBILI SINGOLARMENTE LIST OF SPARE PARTS WHICH CAN BE SUPPLIED SEPARATELY		
CODICE CODE	DESCRIZIONE DESCRIPTION	Q.TÀ QTY
B160	CILINDRO MOTORE MOTOR CYLINDER	1
B174	ALBERO PISTONE PISTON	1
B456	TUBO PESCANTE SUCTION TUBE	1
B457	GHIERA REGOLAZIONE REGULATING RING NUT	1
B462	STELO PESCANTE PUMPING ROD	1
KC375	PISTONE MOTORE PISTON	1
KG220	GUARNIZIONI GASKETS	2
M094	VITE M8x20 SCREW M8x20	6
M520	SPINA ELASTICA PIN	1
M523	SPINA ELASTICA PIN	1
N095	MOLLA SPRING	1
N097	MOLLA SPRING	1
O004	FILTRO ARIA AIR FILTER	1
O006	SILENZIATORE MUFFLER	1
P034	PIASTRA SUPERIORE UPPER FLANGE	1
P035	PIASTRA INFERIORE LOWER FLANGE	1
P041	GUANCIA SINISTRA LEFT COVER	1
P042	GUANCIA DESTRA RIGHT COVER	1
P089	CORPO INFERIORE LOWER BODY	1
P133	CORPO SUPERIORE UPPER BODY	1

KIT GUARNIZIONI COMPLETI TUTTE LE GUARNIZIONI (H...) MENZIONATE NELL'ESPLOSO SONO FORNIBILI ANCHE SINGOLARMENTE		
COMPLETE GASKETS KIT ALL THE O-RING (H...) MENTIONED IN THE EXPLODED VIEW CAN BE SUPPLIED SEPARATELY		
CODICE CODE	DESCRIZIONE DESCRIPTION	Q.TÀ QTY
KR9050	KIT GUARNIZIONI MOTORE SUPERIORE GASKETS KIT FOR UPPER MOTOR	1
KR9055	KIT GUARNIZIONI PISTONE ø 90 GASKETS KIT FOR PISTON ø 90	1
KR9154	KIT GUARNIZIONI MOTORE INFERIORE GASKETS KIT FOR LOWER MOTOR	1
KR9155	KIT GUARNIZIONI PESCANTE GASKETS KIT FOR SUCTION TUBE	1

CODICE CODE	DESCRIZIONE DESCRIPTION	Q.TÀ QTY
Art. KS9186	SET RICAMBI CONSIGLIATI AI PUNTI VENDITA E ASSISTENZA, COMPOSTO DAI RICAMBI SOTTO ELENCATI. SPARE PARTS KIT ADVISED TO THE SELLING CENTERS. THIS KIT INCLUDES ALL THE SPARE PARTS SHOWN HERE UNDER.	
KR9003	GRUPPO DISTRIBUZIONE ARIA SLIDE VALVE GROUP	1
KR9050	KIT GUARNIZIONI MOTORE SUPERIORE GASKETS KIT FOR UPPER MOTOR	1
KR9055	KIT GUARNIZIONI PISTONE ø 90 GASKETS KIT FOR PISTON ø 90	1
KR9154	KIT GUARNIZIONI MOTORE INFERIORE GASKETS KIT FOR LOWER MOTOR	1
KR9155	KIT GUARNIZIONI PESCANTE GASKETS KIT FOR SUCTION TUBE	1

PDFfill PDF Editor with Free Writer and Tools



Art. 90D/21 Mod. 900D-2100



VISTA ESPLOSA - EXPLODED VIEW



POMPA DISSOCIATA S.900
R 2:1 - 95 l/min
DIVORCED PUMP S. 900
R 2:1 - 95 l/min

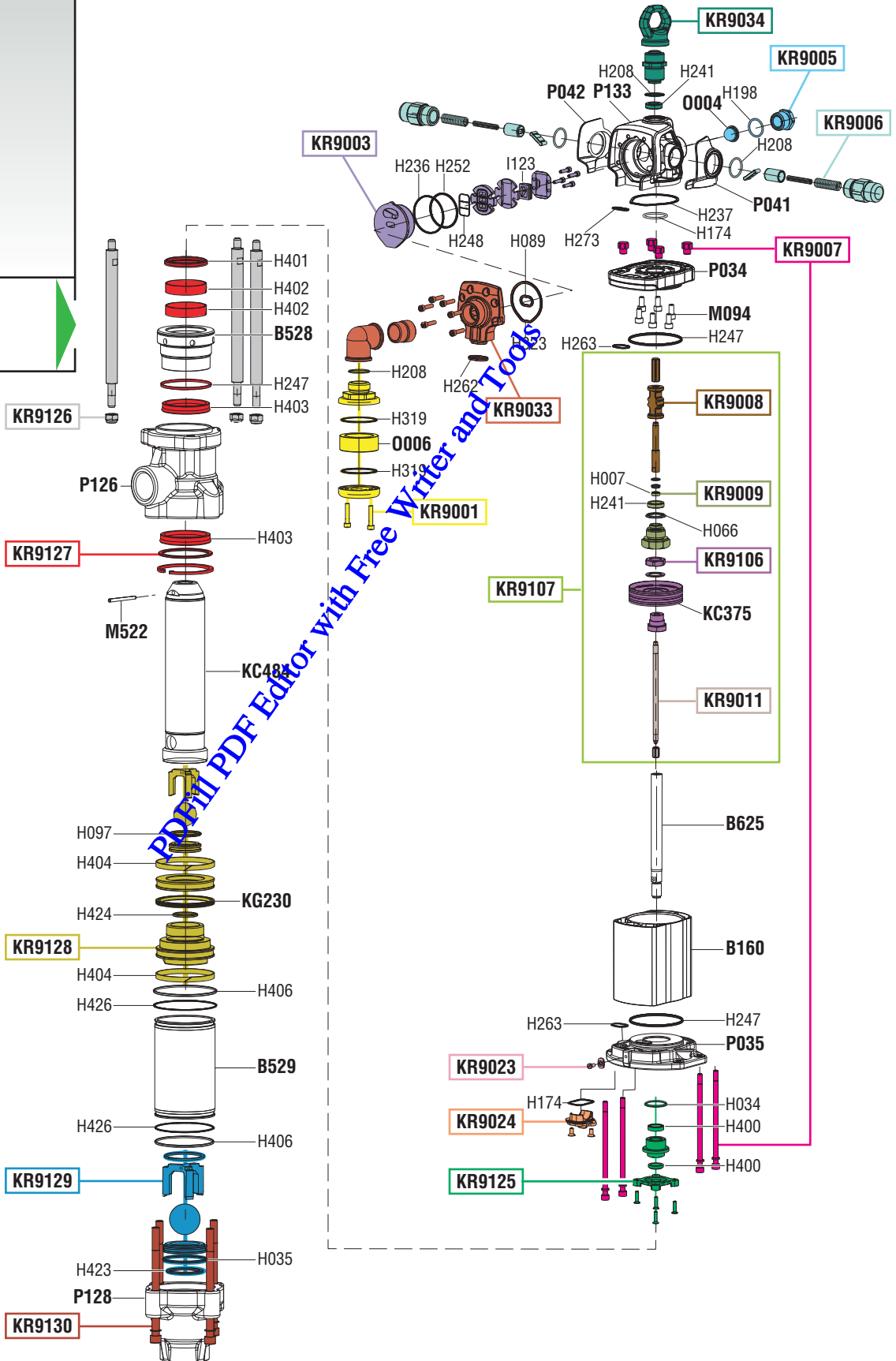

PDF Editor with Free Writer and Tools

tutti i diritti riservati - all rights reserved

GUIDA RICAMBI - SPARE PARTS GUIDE

KIT RICAMBI OGNI KIT SOTTO RIPORTATO COMPRENDE I RICAMBI EVIDENZIATI CON LO STESSO COLORE E LE RELATIVE GUARNIZIONI. QUESTI RICAMBI NON SONO FORNIBILI SEPARATAMENTE TRANNE QUELLI CODIFICATI.		
SPARE PARTS KITS EACH KIT SHOWN WITH THE SAME COLOR INCLUDES ALSO THE GASKETS. THE SPARE PARTS INCLUDED IN THE KIT CAN'T BE SUPPLIED SEPARATELY EXCEPT THOSE SHOWN WITH A PROPER CODE.		
CODICE CODE	DESCRIZIONE DESCRIPTION	Q.TÀ QTY
KR9001	SILENZIATORE MUFFLER	1
KR9003	GRUPPO DISTRIBUTORE D'ARIA SLIDE VALVE GROUP	1
KR9005	RIDUZIONE ENTRATA AIR INLET CONNECTION	1
KR9006	BOSSOLI INVERTITORE BUSHES	1
KR9007	PRIGIONIERI STUD BOLTS	1
KR9008	GRUPPO INVERTITORE PLUNGER GROUP	1
KR9009	TAPPO SUPERIORE UPPER PLUG	1
KR9011	ASTA INVERTITORE ROD	1
KR9023	MESSA A TERRA GROUNDED	1
KR9024	COLLETTORE MANIFOLD	1
KR9033	COLLETTORE DI SCARICO DISCHARGE CONNECTION	1
KR9034	BOSSOLO GUIDA STELO BUSH	1
KR9106	PISTONE MOTORE AIR PISTON	1
KR9107	GRUPPO DISTRIBUZIONE DISTRIBUTION GROUP	1
KR9125	GRUPPO TENUTA SUPERIORE UPPER SEAL GROUP	1
KR9126	PRIGIONIERI STUD BOLTS	1
KR9127	GRUPPO TENUTA INFERIORE LOWER SEAL GROUP	1
KR9128	PISTONE POMPANTE PUMPING PISTON	1
KR9129	VALVOLA DI FONDO BOTTOM VALVE	1
KR9130	PRIGIONIERI STUD BOLTS	1

ELENCO RICAMBI FORNIBILI SINGOLARMENTE LIST OF SPARE PARTS WHICH CAN BE SUPPLIED SEPARATELY		
CODICE CODE	DESCRIZIONE DESCRIPTION	Q.TÀ QTY
B160	CILINDRO MOTORE MOTOR CYLINDER	1
B528	GHIERA CHIUSURA LOCKUP RING NUT	1
B529	TUBO PESCANTE SUCTION TUBE	1
B625	ALBERO PISTONE PISTON	1
KC375	PISTONE MOTORE PISTON	1
KC484	STELO POMPANTE PUMPING ROD	1
KG230	GUARNIZIONE PISTONE PISTON GASKET	1
M094	VITE M8x20 SCREW M8x20	6
M522	SPINA ELASTICA PIN	1
0004	FILTRO ARIA AIR FILTER	1
0006	SILENZIATORE MUFFLER	1
P034	PIASTRA SUPERIORE UPPER FLANGE	1
P035	PIASTRA INFERIORE LOWER FLANGE	1
P041	GUANCIA SINISTRA LEFT COVER	1
P042	GUANCIA DESTRA RIGHT COVER	1
P126	CORPO INFERIORE LOWER BODY	1
P128	CORPO INFERIORE PESCANTE LOWER SUCTION BODY	1
P133	CORPO SUPERIORE UPPER BODY	1

KIT GUARNIZIONI COMPLETI TUTTE LE GUARNIZIONI (H...) MENZIONATE NELL'ESPLOSO SONO FORNIBILI ANCHE SINGOLARMENTE		
COMPLETE GASKETS KIT ALL THE O-RING (H...) MENTIONED IN THE EXPLODED VIEW CAN BE SUPPLIED SEPARATELY		
CODICE CODE	DESCRIZIONE DESCRIPTION	Q.TÀ QTY
KR9050	KIT GUARNIZIONI MOTORE SUPERIORE GASKETS KIT FOR UPPER MOTOR	1
KR9055	KIT GUARNIZIONI PISTONE ø 90 GASKETS KIT FOR PISTON ø 90	1
KR9160	KIT GUARNIZIONI MOTORE INFERIORE GASKETS KIT FOR LOWER MOTOR	1
KR9161	KIT GUARNIZIONI PESCANTE GASKETS KIT FOR SUCTION TUBE	1

PDFfill PDF Editor with Free Writer and Tools

SET RICAMBI CONSIGLIATI AI PUNTI VENDITA E ASSISTENZA, COMPOSTO DAI RICAMBI SOTTO ELENCATI.		
SPARE PARTS KIT ADVISED TO THE SELLING CENTERS, THIS KIT INCLUDES ALL THE SPARE PARTS SHOWN HERE UNDER.		
CODICE CODE	DESCRIZIONE DESCRIPTION	Q.TÀ QTY
KR9003	GRUPPO DISTRIBUZIONE ARIA SLIDE VALVE GROUP	1
KR9050	KIT GUARNIZIONI MOTORE SUPERIORE GASKETS KIT FOR UPPER MOTOR	1
KR9055	KIT GUARNIZIONI PISTONE ø 90 GASKETS KIT FOR PISTON ø 90	1
KR9160	KIT GUARNIZIONI MOTORE INFERIORE GASKETS KIT FOR LOWER MOTOR	1
KR9161	KIT GUARNIZIONI PESCANTE GASKETS KIT FOR SUCTION TUBE	1



Art. 90D/51 Mod. 900D-5100



VISTA ESPLOSA - EXPLODED VIEW



POMPA DISSOCIATA S. 900
R. 5:1 - 45 l/min
DIVORCED PUMP S. 900
R 5:1 - 45 l/min

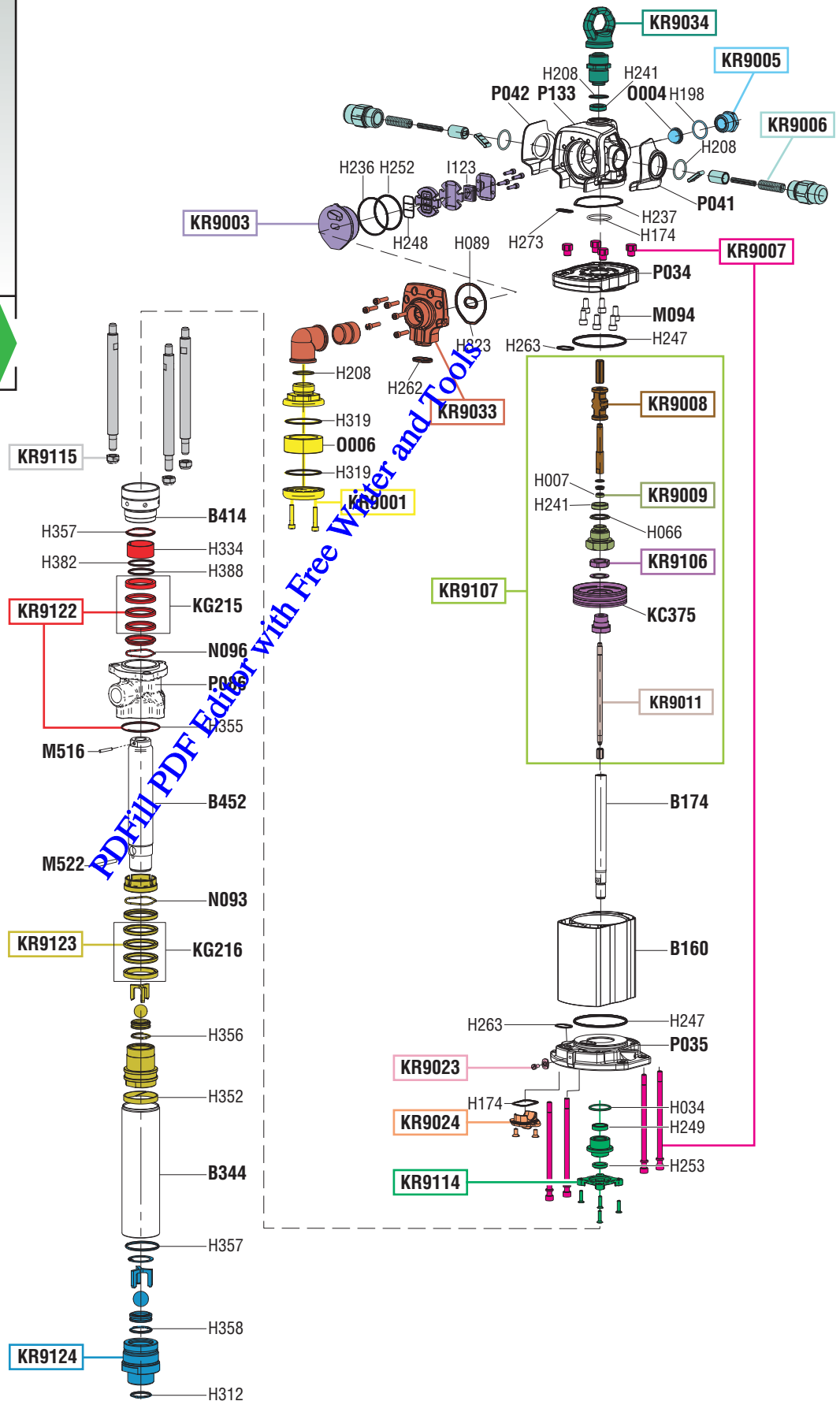

tutti i diritti riservati - all rights reserved

GUIDA RICAMBI - SPARE PARTS GUIDE

KIT RICAMBI
OGNI KIT SOTTO RIPORTATO COMPRENDE I RICAMBI EVIDENZIATI CON LO STESSO COLORE E LE RELATIVE GUARNIZIONI. QUESTI RICAMBI NON SONO FORNIBILI SEPARATAMENTE TRANNE QUELLI CODIFICATI.

SPARE PARTS KITS

EACH KIT SHOWN WITH THE SAME COLOR INCLUDES ALSO THE GASKETS. THE SPARE PARTS INCLUDED IN THE KIT CAN'T BE SUPPLIED SEPARATELY EXCEPT THOSE SHOWN WITH A PROPER CODE.

CODICE CODE	DESCRIZIONE DESCRIPTION	Q.TÀ QTY
KR9001	SILENZIATORE MUFFLER	1
KR9003	GRUPPO DISTRIBUTORE D'ARIA SLIDE VALVE GROUP	1
KR9005	RIDUZIONE ENTRATA AIR INLET CONNECTION	1
KR9006	BOSSOLI INVERTITORE BUSHES	1
KR9007	PRIGIONIERI STUD BOLTS	1
KR9008	GRUPPO INVERTITORE PLUNGER GROUP	1
KR9009	TAPPO SUPERIORE UPPER PLUG	1
KR9011	ASTA INVERTITORE ROD	1
KR9023	MESSA A TERRA GROUNDED	1
KR9024	COLLETTORE MANIFOLD	1
KR9033	COLLETTORE DI SCARICO DISCHARGE CONNECTION	1
KR9034	GOLFARO CON BOSSOLO GUIDA STELO BUSH	1
KR9106	PISTONE MOTORE AIR PISTON	1
KR9107	GRUPPO DISTRIBUZIONE DISTRIBUTION GROUP	1
KR9114	GRUPPO TENUTA INFERIORE LOWER SEAL GROUP	1
KR9115	PRIGIONIERI STUD BOLTS	1
KR9122	GRUPPO TENUTA INFERIORE LOWER SEAL GROUP	1
KR9123	PISTONE POMPANTE PUMPING PISTON	1
KR9124	VALVOLA DI FONDO BOTTOM VALVE	1

ELENCO RICAMBI FORNIBILI SINGOLARMENTE
LIST OF SPARE PARTS WHICH CAN BE SUPPLIED SEPARATELY

CODICE CODE	DESCRIZIONE DESCRIPTION	Q.TÀ QTY
B160	CILINDRO MOTORE MOTOR CYLINDER	1
B174	ALBERO PISTONE PISTON	1
B344	TUBO PESCANTE SUCTION TUBE	1
B414	GHIERA REGOLAZIONE REGULATING RING NUT	1
B452	STELO PESCANTE PUMPING ROD	1
KC375	PISTONE MOTORE PISTON	1
KG215	GUARNIZIONI GASKETS	1
KG216	GUARNIZIONI GASKETS	1
M094	VITE M8x20 SCREW M8x20	6
M516	SPINA ELASTICA PIN	1
M522	SPINA ELASTICA PIN	1
N093	MOLLA SPRING	1
N096	MOLLA SPRING	1
0004	FILTRO ARIA AIR FILTER	1
0006	SILENZIATORE MUFFLER	1
P034	PIASTRA SUPERIORE UPPER FLANGE	1
P035	PIASTRA INFERIORE LOWER FLANGE	1
P041	GUANCIA SINISTRA LEFT COVER	1
P042	GUANCIA DESTRA RIGHT COVER	1
P086	CORPO INFERIORE LOWER BODY	1
P133	CORPO SUPERIORE UPPER BODY	1

KIT GUARNIZIONI COMPLETI

TUTTE LE GUARNIZIONI (H...) MENZIONATE NELL'ESPLOSO SONO FORNIBILI ANCHE SINGOLARMENTE

COMPLETE GASKETS KIT

ALL THE O-RING (H...) MENTIONED IN THE EXPLODED VIEW CAN BE SUPPLIED SEPARATELY

CODICE CODE	DESCRIZIONE DESCRIPTION	Q.TÀ QTY
KR9050	KIT GUARNIZIONI MOTORE SUPERIORE GASKETS KIT FOR UPPER MOTOR	1
KR9055	KIT GUARNIZIONI PISTONE ø 90 GASKETS KIT FOR PISTON ø 90	1
KR9158	KIT GUARNIZIONI MOTORE INFERIORE GASKETS KIT FOR LOWER MOTOR	1
KR9159	KIT GUARNIZIONI PESCANTE GASKETS KIT FOR SUCTION TUBE	1

Art.
KS9188

SET RICAMBI CONSIGLIATI

AI PUNTI VENDITA E ASSISTENZA, COMPOSTO DAI RICAMBI SOTTO ELENCATI.

SPARE PARTS KIT ADVISED

TO THE SELLING CENTERS. THIS KIT INCLUDES ALL THE SPARE PARTS SHOWN HERE UNDER.

CODICE CODE	DESCRIZIONE DESCRIPTION	Q.TÀ QTY
KR9003	GRUPPO DISTRIBUZIONE ARIA SLIDE VALVE GROUP	1
KR9050	KIT GUARNIZIONI MOTORE SUPERIORE GASKETS KIT FOR UPPER MOTOR	1
KR9055	KIT GUARNIZIONI PISTONE ø 90 GASKETS KIT FOR PISTON ø 90	1
KR9158	KIT GUARNIZIONI MOTORE INFERIORE GASKETS KIT FOR LOWER MOTOR	1
KR9159	KIT GUARNIZIONI PESCANTE GASKETS KIT FOR SUCTION TUBE	1

RAASM

FLUIDS AND LUBRICATION EQUIPMENT



Art. 90D/71 Mod. 900D-7100



VISTA ESPLOSA - EXPLODED VIEW



POMPA DISSOCIATA S. 900
R. 7:1 - 30 l/min
DIVORCED PUMP S. 900
R 7:1 - 30 l/min

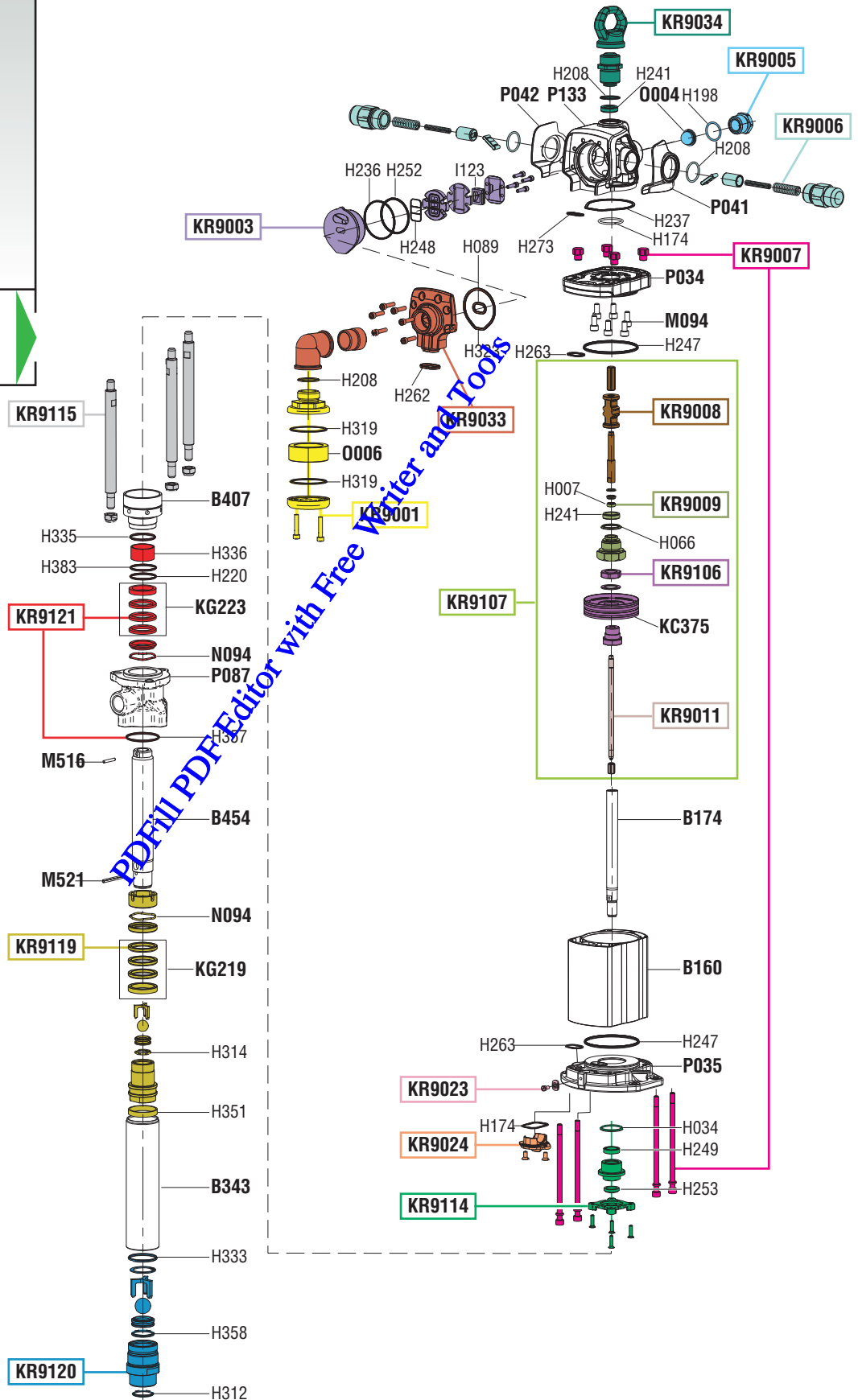

PDF Editor with Free Writer and Tools

tutti i diritti riservati - all rights reserved

GUIDA RICAMBI - SPARE PARTS GUIDE

KIT RICAMBI OGNI KIT SOTTO RIPORTATO COMPRENDE I RICAMBI EVIDENZIATI CON LO STESSO COLORE E LE RELATIVE GUARNIZIONI. QUESTI RICAMBI NON SONO FORNIBILI SEPARATAMENTE TRANNE QUELLI CODIFICATI.		
SPARE PARTS KITS EACH KIT SHOWN WITH THE SAME COLOR INCLUDES ALSO THE GASKETS. THE SPARE PARTS INCLUDED IN THE KIT CAN'T BE SUPPLIED SEPARATELY EXCEPT THOSE SHOWN WITH A PROPER CODE.		
CODICE CODE	DESCRIZIONE DESCRIPTION	Q.TÀ QTY
KR9001	SILENZIATORE MUFFLER	1
KR9003	GRUPPO DISTRIBUTORE D'ARIA SLIDE VALVE GROUP	1
KR9005	RIDUZIONE ENTRATA AIR INLET CONNECTION	1
KR9006	BOSSOLI INVERTITORE BUSHES	1
KR9007	PRIGIONIERI STUD BOLTS	1
KR9008	GRUPPO INVERTITORE PLUNGER GROUP	1
KR9009	TAPPO SUPERIORE UPPER PLUG	1
KR9011	ASTA INVERTITORE ROD	1
KR9023	MESSA A TERRA GROUNDED	1
KR9024	COLLETTORE MANIFOLD	1
KR9033	COLLETTORE DI SCARICO DISCHARGE CONNECTION	1
KR9034	GOLFARO CON BOSSOLO GUIDA STELO BUSH	1
KR9106	PISTONE MOTORE AIR PISTON	1
KR9107	GRUPPO DISTRIBUZIONE DISTRIBUTION GROUP	1
KR9114	GRUPPO TENUTA INFERIORE LOWER SEAL GROUP	1
KR9115	PRIGIONIERI STUD BOLTS	1
KR9119	PISTONE POMPANTE PUMPING PISTON	1
KR9120	VALVOLA DI FONDO BOTTOM VALVE	1
KR9121	GRUPPO TENUTA INFERIORE LOWER SEAL GROUP	1

ELENCO RICAMBI FORNIBILI SINGOLARMENTE LIST OF SPARE PARTS WHICH CAN BE SUPPLIED SEPARATELY		
CODICE CODE	DESCRIZIONE DESCRIPTION	Q.TÀ QTY
B160	CILINDRO MOTORE MOTOR CYLINDER	1
B174	ALBERO PISTONE PISTON	1
B343	TUBO PESCANTE SUCTION TUBE	1
B407	GHIERA REGOLAZIONE REGULATING RING NUT	1
B454	STELO PESCANTE PUMPING ROD	1
KC375	PISTONE MOTORE PISTON	1
KG219	GUARNIZIONI GASKETS	1
KG223	GUARNIZIONI GASKETS	1
M094	VITE M8x20 SCREW M8x20	6
M516	SPINA ELASTICA PIN	1
M521	SPINA ELASTICA PIN	1
N094	MOLLA SPRING	2
O004	FILTRO ARIA AIR FILTER	1
O006	SILENZIATORE MUFFLER	1
P034	PIASTRA SUPERIORE UPPER FLANGE	1
P035	PIASTRA INFERIORE LOWER FLANGE	1
P041	GUANCIA SINISTRA LEFT COVER	1
P042	GUANCIA DESTRA RIGHT COVER	1
P087	CORPO INFERIORE LOWER BODY	1
P133	CORPO SUPERIORE UPPER BODY	1

KIT GUARNIZIONI COMPLETI TUTTE LE GUARNIZIONI (H...) MENZIONATE NELL'ESPLOSO SONO FORNIBILI ANCHE SINGOLARMENTE		
COMPLETE GASKETS KIT ALL THE O-RING (H...) MENTIONED IN THE EXPLODED VIEW CAN BE SUPPLIED SEPARATELY		
CODICE CODE	DESCRIZIONE DESCRIPTION	Q.TÀ QTY
KR9050	KIT GUARNIZIONI MOTORE SUPERIORE GASKETS KIT FOR UPPER MOTOR	1
KR9055	KIT GUARNIZIONI PISTONE ø 90 GASKETS KIT FOR PISTON ø 90	1
KR9156	KIT GUARNIZIONI MOTORE INFERIORE GASKETS KIT FOR LOWER MOTOR	1
KR9157	KIT GUARNIZIONI PESCANTE GASKETS KIT FOR SUCTION TUBE	1

Art. KS9187	SET RICAMBI CONSIGLIATI AI PUNTI VENDITA E ASSISTENZA, COMPOSTO DAI RICAMBI SOTTO ELENCATI. SPARE PARTS KIT ADVISED TO THE SELLING CENTERS. THIS KIT INCLUDES ALL THE SPARE PARTS SHOWN HERE UNDER.	
CODICE CODE	DESCRIZIONE DESCRIPTION	Q.TÀ QTY
KR9003	GRUPPO DISTRIBUZIONE ARIA SLIDE VALVE GROUP	1
KR9050	KIT GUARNIZIONI MOTORE SUPERIORE GASKETS KIT FOR UPPER MOTOR	1
KR9055	KIT GUARNIZIONI PISTONE ø 90 GASKETS KIT FOR PISTON ø 90	1
KR9156	KIT GUARNIZIONI MOTORE INFERIORE GASKETS KIT FOR LOWER MOTOR	1
KR9157	KIT GUARNIZIONI PESCANTE GASKETS KIT FOR SUCTION TUBE	1

PDFill PDF Editor with Free Writer and Tools



Art. 90DV/21 Mod. 900DV-2100



VISTA ESPLOSA - EXPLODED VIEW



POMPA DISSOCIATA S.900
R. 2:1 - 95 l/min "Viton"
DIVORCED PUMP S. 900
R. 2:1 - 95 l/min "Viton"

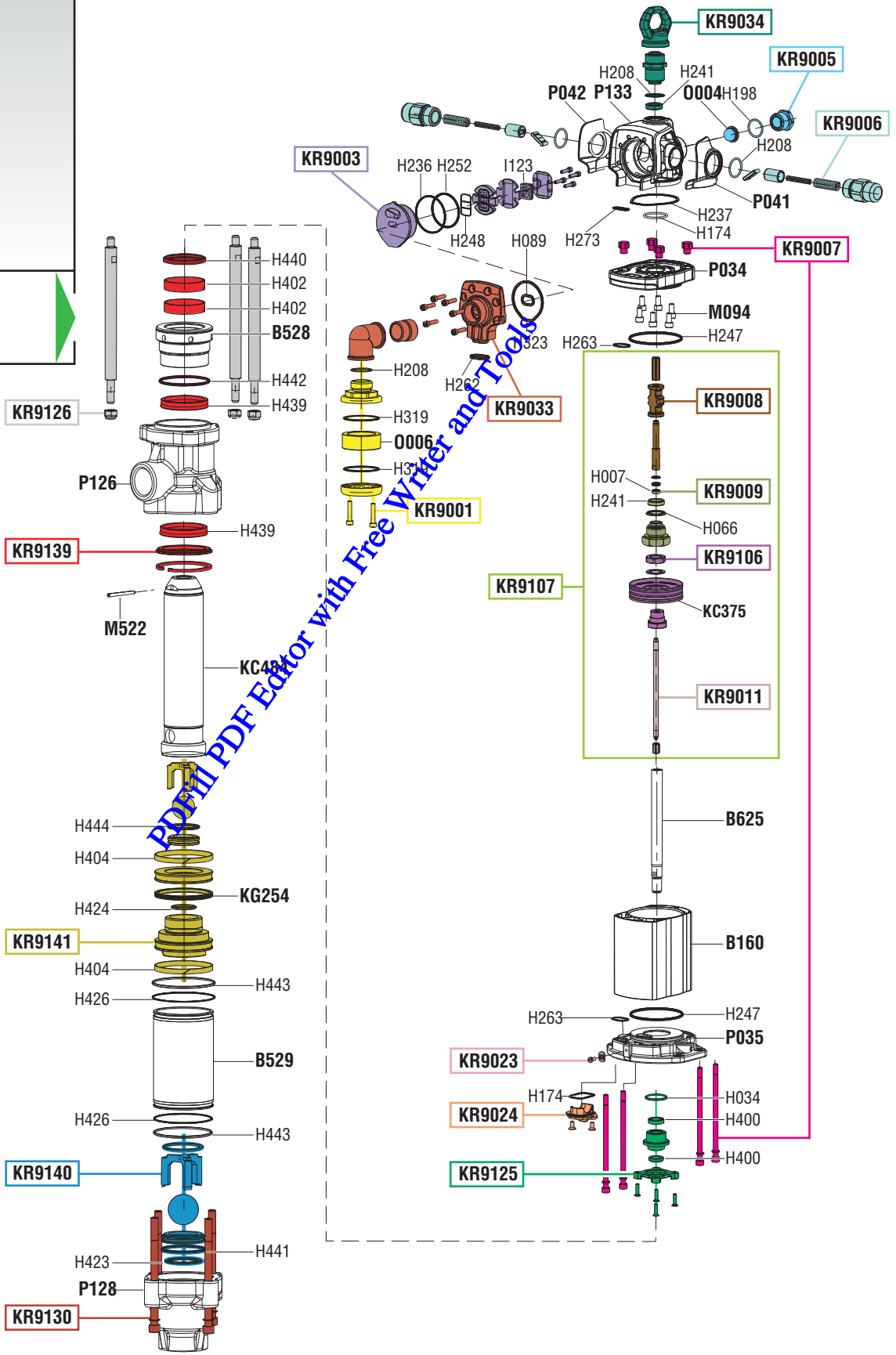

PDF FILE Editor with Free Writer and Tools

tutti i diritti riservati - all rights reserved

GUIDA RICAMBI - SPARE PARTS GUIDE

KIT RICAMBI

OGNI KIT SOTTO RIPORTATO COMPRENDE I RICAMBI EVIDENZIATI CON LO STESSO COLORE E LE RELATIVE GUARNIZIONI. QUESTI RICAMBI NON SONO FORNIBILI SEPARATAMENTE TRANNE QUELLI CODIFICATI.

SPARE PARTS KITS

EACH KIT SHOWN WITH THE SAME COLOR INCLUDES ALSO THE GASKETS. THE SPARE PARTS INCLUDED IN THE KIT CAN'T BE SUPPLIED SEPARATELY EXCEPT THOSE SHOWN WITH A PROPER CODE.

CODICE CODE	DESCRIZIONE DESCRIPTION	Q.TÀ QTY
KR9001	SILENZIATORE MUFFLER	1
KR9003	GRUPPO DISTRIBUTORE D'ARIA SLIDE VALVE GROUP	1
KR9005	RIDUZIONE ENTRATA AIR INLET CONNECTION	1
KR9006	BOSSOLI INVERTITORE BUSHES	1
KR9007	PRIGIONIERI STUD BOLTS	1
KR9008	GRUPPO INVERTITORE PLUNGER GROUP	1
KR9009	TAPPO SUPERIORE UPPER PLUG	1
KR9011	ASTA INVERTITORE ROD	1
KR9023	MESSA A TERRA GROUNDED	1
KR9024	COLLETTORE MANIFOLD	1
KR9033	COLLETTORE DI SCARICO DISCHARGE CONNECTION	1
KR9034	BOSSOLO GUIDA STELO BUSH	1
KR9106	PISTONE MOTORE AIR PISTON	1
KR9107	GRUPPO DISTRIBUZIONE DISTRIBUTION GROUP	1
KR9125	GRUPPO TENUTA SUPERIORE UPPER SEAL GROUP	1
KR9126	PRIGIONIERI STUD BOLTS	1
KR9130	PRIGIONIERI STUD BOLTS	1
KR9139	GRUPPO TENUTA INFERIORE LOWER SEAL GROUP	1
KR9140	VALVOLA DI FONDO BOTTOM VALVE	1
KR9141	PISTONE POMPANTE PUMPING PISTON	1

ELENCO RICAMBI FORNIBILI SINGOLARMENTE
LIST OF SPARE PARTS WHICH CAN BE SUPPLIED SEPARATELY

CODICE CODE	DESCRIZIONE DESCRIPTION	Q.TÀ QTY
B160	CILINDRO MOTORE MOTOR CYLINDER	1
B528	GHIERA CHIUSURA LOCKUP RING NUT	1
B529	TUBO PESCANTE SUCTION TUBE	1
B625	ALBERO PISTONE PISTON	1
KC375	PISTONE MOTORE PISTON	1
KC484	STELO POMPANTE PUMPING ROD	1
KG254	GUARNIZIONE PISTONE PISTON GASKET	1
M094	VITE M8x20 SCREW M8x20	6
M522	SPINA ELASTICA PIN	1
0004	FILTRO ARIA AIR FILTER	1
0006	SILENZIATORE MUFFLER	1
P034	PIASTRA SUPERIORE UPPER FLANGE	1
P035	PIASTRA INFERIORE LOWER FLANGE	1
P041	GUANCIA SINISTRA LEFT COVER	1
P042	GUANCIA DESTRA RIGHT COVER	1
P126	CORPO INFERIORE LOWER BODY	1
P128	CORPO INFERIORE PESCANTE LOWER SUCTION BODY	1
P133	CORPO SUPERIORE UPPER BODY	1

KIT GUARNIZIONI COMPLETI

TUTTE LE GUARNIZIONI (H...) MENZIONATE NELL'ESPLOSO SONO FORNIBILI ANCHE SINGOLARMENTE

COMPLETE GASKETS KIT

ALL THE O-RING (H...) MENTIONED IN THE EXPLODED VIEW CAN BE SUPPLIED SEPARATELY

CODICE CODE	DESCRIZIONE DESCRIPTION	Q.TÀ QTY
KR9050	KIT GUARNIZIONI MOTORE SUPERIORE GASKETS KIT FOR UPPER MOTOR	1
KR9055	KIT GUARNIZIONI PISTONE ø 90 GASKETS KIT FOR PISTON ø 90	1
KR9164	KIT GUARNIZIONI MOTORE INFERIORE GASKETS KIT FOR LOWER MOTOR	1
KR9165	KIT GUARNIZIONI PESCANTE GASKETS KIT FOR SUCTION TUBE	1

ART.
KS9090**SET RICAMBI CONSIGLIATI**

AI PUNTI VENDITA E ASSISTENZA, COMPOSTO DAI RICAMBI SOTTO ELENCATI.

SPARE PARTS KIT ADVISED

TO THE SELLING CENTERS, THIS KIT INCLUDES ALL THE SPARE PARTS SHOWN HERE UNDER.

CODICE CODE	DESCRIZIONE DESCRIPTION	Q.TÀ QTY
KR9003	GRUPPO DISTRIBUZIONE ARIA SLIDE VALVE GROUP	1
KR9050	KIT GUARNIZIONI MOTORE SUPERIORE GASKETS KIT FOR UPPER MOTOR	1
KR9055	KIT GUARNIZIONI PISTONE ø 90 GASKETS KIT FOR PISTON ø 90	1
KR9164	KIT GUARNIZIONI MOTORE INFERIORE GASKETS KIT FOR LOWER MOTOR	1
KR9165	KIT GUARNIZIONI PESCANTE GASKETS KIT FOR SUCTION TUBE	1

PDFill PDF Editor with Free Writer and Tools

GUIDA RICAMBI - SPARE PARTS GUIDE

KIT RICAMBI OGNI KIT SOTTO RIPORTATO COMPRENDE I RICAMBI EVIDENZIATI CON LO STESSO COLORE E LE RELATIVE GUARNIZIONI. QUESTI RICAMBI NON SONO FORNIBILI SEPARATAMENTE TRANNE QUELLI CODIFICATI.		
SPARE PARTS KITS EACH KIT SHOWN WITH THE SAME COLOR INCLUDES ALSO THE GASKETS. THE SPARE PARTS INCLUDED IN THE KIT CAN'T BE SUPPLIED SEPARATELY EXCEPT THOSE SHOWN WITH A PROPER CODE.		
CODICE CODE	DESCRIZIONE DESCRIPTION	Q.TÀ QTY
10/16	MANIGLIE HANDLES	1
KR9001	SILENZIATORE MUFFLER	1
KR9003	GRUPPO DISTRIBUTORE D'ARIA SLIDE VALVE GROUP	1
KR9005	RIDUZIONE ENTRATA AIR INLET CONNECTION	1
KR9006	BOSSOLI INVERTITORE BUSHES	1
KR9007	PRIGIONIERI STUD BOLTS	1
KR9008	GRUPPO INVERTITORE PLUNGER GROUP	1
KR9009	TAPPO SUPERIORE UPPER PLUG	1
KR9010	PISTONE MOTORE AIR PISTON	1
KR9011	ASTA INVERTITORE ROD	1
KR9012	GRUPPO DISTRIBUZIONE DISTRIBUTION GROUP	1
KR9023	MESSA A TERRA GROUNDED	1
KR9024	COLLETTORE MANIFOLD	1
KR9027	GRUPPO TENUTA INFERIORE LOWER SEAL GROUP	1
KR9028	PISTONE POMPANTE PUMPING PISTON	1
KR9029	VALVOLA DI FONDO BOTTOM VALVE	1
KR9033	COLLETTORE DI SCARICO DISCHARGE CONNECTION	1
KR9034	GOLFARO CON BOSSOLO GUIDA STELO BUSH	1

ELENCO RICAMBI FORNIBILI SINGOLARMENTE LIST OF SPARE PARTS WHICH CAN BE SUPPLIED SEPARATELY		
CODICE CODE	DESCRIZIONE DESCRIPTION	Q.TÀ QTY
B160	CILINDRO MOTORE MOTOR CYLINDER	1
B439	STELO MOTORE ROD	1
B441	TUBO PESCANTE (91F/111) SUCTION TUBE (91F/111)	1
B638	STELO PESCANTE (90F/111) ROD (90F/111)	1
B639	TUBO PESCANTE (90F/111) SUCTION TUBE (90F/111)	1
B687	STELO PESCANTE (91F/111) ROD (91F/111)	1
KC375	PISTONE MOTORE PISTON	1
M094	VITE M8x20 SCREW M8x20	6
M100	VITE M12X25 SCREW M12X25	3
M502	SPINA ELASTICA PIN	1
0004	FILTRO ARIA AIR FILTER	1
0006	SILENZIATORE MUFFLER	1
P034	PIASTRA SUPERIORE UPPER FLANGE	1
P035	PIASTRA INFERIORE LOWER FLANGE	1
P041	GUANCIA SINISTRA LEFT COVER	1
P042	GUANCIA DESTRA RIGHT COVER	1
P088	CORPO INFERIORE LOWER BODY	1
P133	CORPO SUPERIORE UPPER BODY	1

KIT GUARNIZIONI COMPLETI TUTTE LE GUARNIZIONI (H...) MENZIONATE NELL'ESPLOSO SONO FORNIBILI ANCHE SINGOLARMENTE		
COMPLETE GASKETS KIT ALL THE O-RING (H...) MENTIONED IN THE EXPLODED VIEW CAN BE SUPPLIED SEPARATELY		
CODICE CODE	DESCRIZIONE DESCRIPTION	Q.TÀ QTY
KR9050	KIT GUARNIZIONI MOTORE SUPERIORE GASKETS KIT FOR UPPER MOTOR	1
KR9055	KIT GUARNIZIONI PISTONE ø 90 GASKETS KIT FOR PISTON ø 90	1
KR9059	GRUPPO TENUTA INFERIORE LOWER SEAL GROUP	1
KR9060	KIT GUARNIZIONI PESCANTE GASKETS KIT FOR SUCTION TUBE	1

Art. KS9086		
SET RICAMBI CONSIGLIATI AI PUNTI VENDITA E ASSISTENZA, COMPOSTO DAI RICAMBI SOTTO ELENCATI.		
SPARE PARTS KIT ADVISED TO THE SELLING CENTERS, THIS KIT INCLUDES ALL THE SPARE PARTS SHOWN HERE UNDER.		
CODICE CODE	DESCRIZIONE DESCRIPTION	Q.TÀ QTY
KR9003	GRUPPO DISTRIBUZIONE ARIA SLIDE VALVE GROUP	1
KR9050	KIT GUARNIZIONI MOTORE SUPERIORE GASKETS KIT FOR UPPER MOTOR	1
KR9055	KIT GUARNIZIONI PISTONE ø 90 GASKETS KIT FOR PISTON ø 90	1
KR9059	GRUPPO TENUTA INFERIORE LOWER SEAL GROUP	1
KR9060	KIT GUARNIZIONI PESCANTE GASKETS KIT FOR SUCTION TUBE	1

PDFfill PDF Editor with Free Writer and Tools

GUIDA RICAMBI - SPARE PARTS GUIDE

KIT RICAMBI OGNI KIT SOTTO RIPORTATO COMPRENDE I RICAMBI EVIDENZIATI CON LO STESSO COLORE E LE RELATIVE GUARNIZIONI. QUESTI RICAMBI NON SONO FORNIBILI SEPARATAMENTE TRANNE QUELLI CODIFICATI.		
SPARE PARTS KITS EACH KIT SHOWN WITH THE SAME COLOR INCLUDES ALSO THE GASKETS. THE SPARE PARTS INCLUDED IN THE KIT CAN'T BE SUPPLIED SEPARATELY EXCEPT THOSE SHOWN WITH A PROPER CODE.		
CODICE CODE	DESCRIZIONE DESCRIPTION	Q.TÀ QTY
10/16	MANIGLIE HANDLES	1
KR9001	SILENZIATORE MUFFLER	1
KR9003	GRUPPO DISTRIBUTORE D'ARIA SLIDE VALVE GROUP	1
KR9005	RIDUZIONE ENTRATA AIR INLET CONNECTION	1
KR9006	BOSSOLI INVERTITORE BUSHES	1
KR9007	PRIGIONIERI STUD BOLTS	1
KR9008	GRUPPO INVERTITORE PLUNGER GROUP	1
KR9009	TAPPO SUPERIORE UPPER PLUG	1
KR9011	ASTA INVERTITORE ROD	1
KR9023	MESSA A TERRA GROUNDED	1
KR9024	COLLETTORE MANIFOLD	1
KR9033	COLLETTORE DI SCARICO DISCHARGE CONNECTION	1
KR9034	GOLFARO CON BOSSOLO GUIDA STELO BUSH	1
KR9102	GRUPPO TENUTA INFERIORE LOWER SEAL GROUP	1
KR9106	PISTONE MOTORE AIR PISTON	1
KR9107	GRUPPO DISTRIBUZIONE DISTRIBUTION GROUP	1
KR9108	GRUPPO TENUTA SUPERIORE UPPER SEAL GROUP	1
KR9111	GRUPPO POMPANTE PUMPING GROUP	1
KR9112	GRUPPO PREPOMPAGGIO PUMPING GROUP	1
KR9113	FILTRO PESCANTE SHANK FILTER	1

ELENCO RICAMBI FORNIBILI SINGOLARMENTE LIST OF SPARE PARTS WHICH CAN BE SUPPLIED SEPARATELY		
CODICE CODE	DESCRIZIONE DESCRIPTION	Q.TÀ QTY
B160	CILINDRO MOTORE MOTOR CYLINDER	1
B174	ALBERO PISTONE PISTON	1
B182	TERMINALE PESCANTE SHANK END	1
B186	CILINDRO BATTUTA VALVOLA BOTTOM VALVE CILYNDER	1
B641	STELO POMPANTE PUMPING ROD	1
B642	TUBO PESCANTE SUCTION TUBE	1
B989	TERMINALE PESCANTE SHANK END	1
KC375	PISTONE MOTORE PISTON	1
M094	VITE M8x20 SCREW M8x20	6
M100	VITE M12x25 SCREW M12x25	3
M518	SPINA ELASTICA PIN	3
M660	SEGER SEGER	1
0004	FILTRO ARIA AIR FILTER	1
0006	SILENZIATORE MUFFLER	1
P034	PIASTRA SUPERIORE UPPER FLANGE	1
P035	PIASTRA INFERIORE LOWER FLANGE	1
P041	GUANCIA SINISTRA LEFT COVER	1
P042	GUANCIA DESTRA RIGHT COVER	1
P048	CORPO INFERIORE LOWER BODY	1
P133	CORPO SUPERIORE UPPER BODY	1

KIT GUARNIZIONI COMPLETI TUTTE LE GUARNIZIONI (H...) MENZIONATE NELL'ESPLOSO SONO FORNIBILI ANCHE SINGOLARMENTE		
COMPLETE GASKETS KIT ALL THE O-RING (H...) MENTIONED IN THE EXPLODED VIEW CAN BE SUPPLIED SEPARATELY		
CODICE CODE	DESCRIZIONE DESCRIPTION	Q.TÀ QTY
KR9050	KIT GUARNIZIONI MOTORE SUPERIORE GASKETS KIT FOR UPPER MOTOR	1
KR9055	KIT GUARNIZIONI PISTONE ø 90 GASKETS KIT FOR PISTON ø 90	1
KR9152	KIT GUARNIZIONI MOTORE INFERIORE GASKETS KIT FOR LOWER MOTOR	1
KR9153	KIT GUARNIZIONI PESCANTE GASKETS KIT FOR SUCTION TUBE	1

SET RICAMBI CONSIGLIATI AI PUNTI VENDITA E ASSISTENZA, COMPOSTO DAI RICAMBI SOTTO ELENCATI.		
SPARE PARTS KIT ADVISED TO THE SELLING CENTERS, THIS KIT INCLUDES ALL THE SPARE PARTS SHOWN HERE UNDER.		
CODICE CODE	DESCRIZIONE DESCRIPTION	Q.TÀ QTY
KR9003	GRUPPO DISTRIBUZIONE ARIA SLIDE VALVE GROUP	1
KR9050	KIT GUARNIZIONI MOTORE SUPERIORE GASKETS KIT FOR UPPER MOTOR	1
KR9055	KIT GUARNIZIONI PISTONE ø 90 GASKETS KIT FOR PISTON ø 90	1
KR9152	KIT GUARNIZIONI PESCANTE GASKETS KIT FOR SUCTION TUBE	1
KR9153	KIT GUARNIZIONI MOTORE INFERIORE GASKETS KIT FOR LOWER MOTOR	1

PDFfill PDF Editor with Free Writer and Tools

GUIDA RICAMBI - SPARE PARTS GUIDE

KIT RICAMBI OGNI KIT SOTTO RIPORTATO COMPRENDE I RICAMBI EVIDENZIATI CON LO STESSO COLORE E LE RELATIVE GUARNIZIONI. QUESTI RICAMBI NON SONO FORNIBILI SEPARATAMENTE TRANNE QUELLI CODIFICATI.		
SPARE PARTS KITS EACH KIT SHOWN WITH THE SAME COLOR INCLUDES ALSO THE GASKETS. THE SPARE PARTS INCLUDED IN THE KIT CAN'T BE SUPPLIED SEPARATELY EXCEPT THOSE SHOWN WITH A PROPER CODE.		
CODICE CODE	DESCRIZIONE DESCRIPTION	Q.TÀ QTY
10/16	MANIGLIE HANDLES	1
KR9001	SILENZIATORE MUFFLER	1
KR9003	GRUPPO DISTRIBUTORE D'ARIA SLIDE VALVE GROUP	1
KR9005	RIDUZIONE ENTRATA AIR INLET CONNECTION	1
KR9006	BOSSOLI INVERTITORE BUSHES	1
KR9007	PRIGIONIERI STUD BOLTS	1
KR9008	GRUPPO INVERTITORE PLUNGER GROUP	1
KR9009	TAPPO SUPERIORE UPPER PLUG	1
KR9010	PISTONE MOTORE AIR PISTON	1
KR9011	ASTA INVERTITORE ROD	1
KR9012	GRUPPO DISTRIBUZIONE DISTRIBUTION GROUP	1
KR9016	PISTONE POMPANTE PUMPING PISTON	1
KR9017	VALVOLA DI FONDO BOTTOM VALVE	1
KR9023	MESSA A TERRA GROUNDED	1
KR9024	COLLETTORE MANIFOLD	1
KR9025	GRUPPO TENUTA INFERIORE LOWER SEAL GROUP	1
KR9033	COLLETTORE DI SCARICO DISCHARGE CONNECTION	1
KR9034	GOLFARO CON BOSSOLO GUIDA STELO BUSH	1

ELENCO RICAMBI FORNIBILI SINGOLARMENTE LIST OF SPARE PARTS WHICH CAN BE SUPPLIED SEPARATELY		
CODICE CODE	DESCRIZIONE DESCRIPTION	Q.TÀ QTY
B160	CILINDRO MOTORE MOTOR CYLINDER	1
B265	STELO POMPANTE ROD	1
B294	PORTA TUBO HOSE CONNECTION	1
B344	TUBO PESCANTE SUCTION TUBE	1
KC375	PISTONE MOTORE PISTON	1
M094	VITE M8x20 SCREW M8x20	6
M100	VITE M12X25 SCREW M12X25	3
0004	FILTRO ARIA AIR FILTER	1
0006	SILENZIATORE MUFFLER	1
P034	PIASTRA SUPERIORE UPPER FLANGE	1
P035	PIASTRA INFERIORE LOWER FLANGE	1
P041	GUANCIA SINISTRA LEFT COVER	1
P042	GUANCIA DESTRA RIGHT COVER	1
P091	CORPO INFERIORE LOWER BODY	1
P133	CORPO SUPERIORE UPPER BODY	1

KIT GUARNIZIONI COMPLETI TUTTE LE GUARNIZIONI (H...) MENZIONATE NELL'ESPLOSO SONO FORNIBILI ANCHE SINGOLARMENTE		
COMPLETE GASKETS KIT ALL THE O-RING (H...) MENTIONED IN THE EXPLODED VIEW CAN BE SUPPLIED SEPARATELY		
CODICE CODE	DESCRIZIONE DESCRIPTION	Q.TÀ QTY
KR9050	KIT GUARNIZIONI MOTORE SUPERIORE GASKETS KIT FOR UPPER MOTOR	1
KR9052	KIT GUARNIZIONI PESCANTE GASKETS KIT FOR SUCTION TUBE	1
KR9055	KIT GUARNIZIONI PISTONE ø 90 GASKETS KIT FOR PISTON ø 90	1
KR9057	GRUPPO TENUTA INFERIORE LOWER SEAL GROUP	1

Art. KS9082		
SET RICAMBI CONSIGLIATI AI PUNTI VENDITA E ASSISTENZA, COMPOSTO DAI RICAMBI SOTTO ELENCATI.		
SPARE PARTS KIT ADVISED TO THE SELLING CENTERS. THIS KIT INCLUDES ALL THE SPARE PARTS SHOWN HERE UNDER.		
CODICE CODE	DESCRIZIONE DESCRIPTION	Q.TÀ QTY
KR9003	GRUPPO DISTRIBUZIONE ARIA SLIDE VALVE GROUP	1
KR9050	KIT GUARNIZIONI MOTORE SUPERIORE GASKETS KIT FOR UPPER MOTOR	1
KR9052	KIT GUARNIZIONI PESCANTE GASKETS KIT FOR SUCTION TUBE	1
KR9055	KIT GUARNIZIONI PISTONE ø 90 GASKETS KIT FOR PISTON ø 90	1
KR9057	GRUPPO TENUTA INFERIORE LOWER SEAL GROUP	1

PDFfill PDF Editor with Free Writer and Tools



Art. 90F/71 Mod. 900F-7100 - Art. 91F/71 Mod. 900F-7194



VISTA ESPLOSA - EXPLODED VIEW

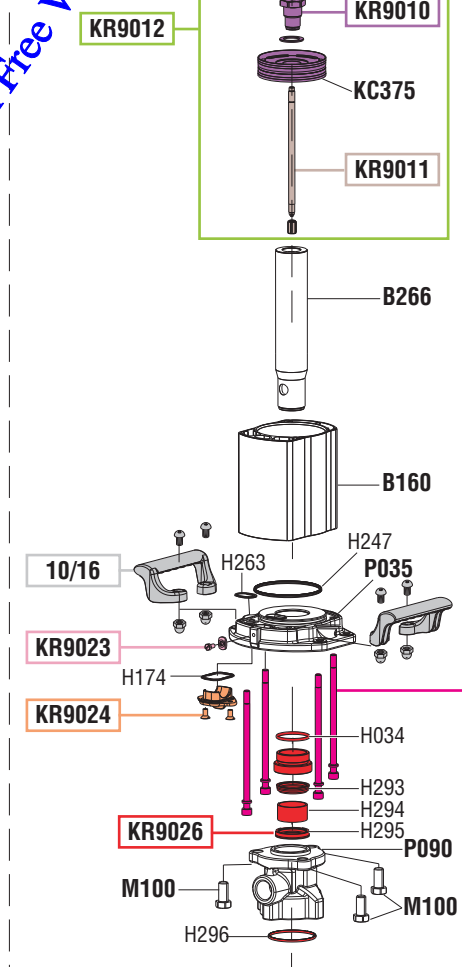
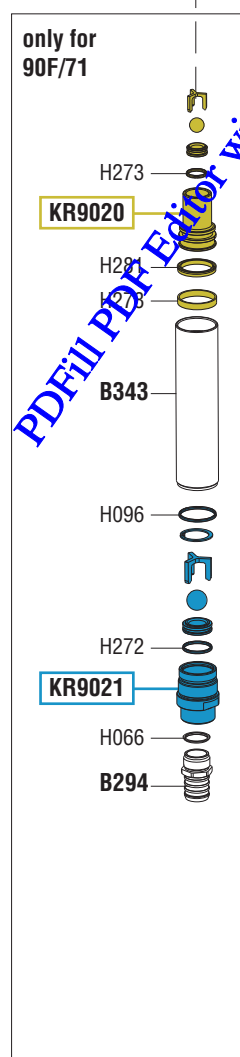
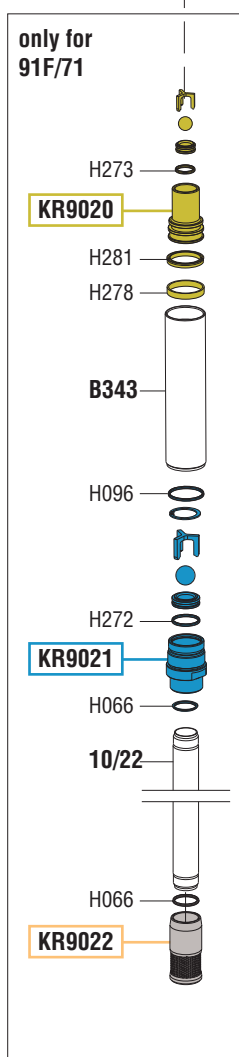
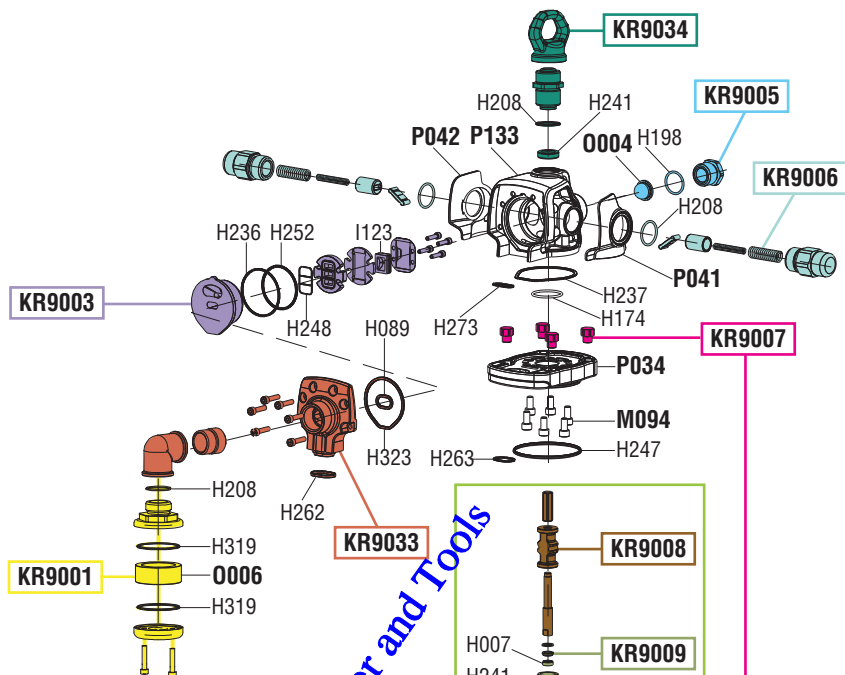
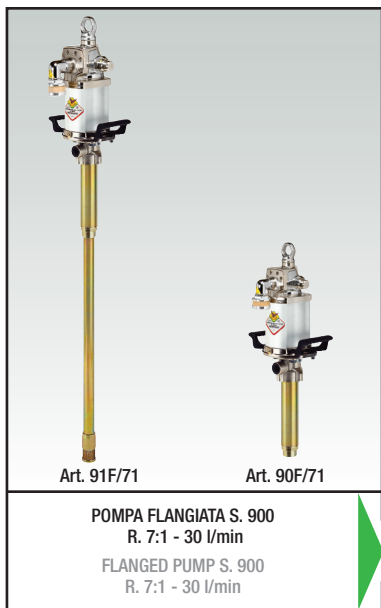

PDFFill PDF Editor with Free Writer and Tools

tutti i diritti riservati - all rights reserved

GUIDA RICAMBI - SPARE PARTS GUIDE

KIT RICAMBI

OGNI KIT SOTTO RIPORTATO COMPRENDE I RICAMBI EVIDENZIATI CON LO STESSO COLORE E LE RELATIVE GUARNIZIONI. QUESTI RICAMBI NON SONO FORNIBILI SEPARATAMENTE TRANNE QUELLI CODIFICATI.

SPARE PARTS KITS

EACH KIT SHOWN WITH THE SAME COLOR INCLUDES ALSO THE GASKETS. THE SPARE PARTS INCLUDED IN THE KIT CAN'T BE SUPPLIED SEPARATELY EXCEPT THOSE SHOWN WITH A PROPER CODE.

CODICE CODE	DESCRIZIONE DESCRIPTION	Q.TÀ QTY
10/16	MANIGLIE HANDLES	1
KR9001	SILENZIATORE MUFFLER	1
KR9003	GRUPPO DISTRIBUTORE D'ARIA SLIDE VALVE GROUP	1
KR9005	RIDUZIONE ENTRATA AIR INLET CONNECTION	1
KR9006	BOSSOLI INVERTITORE BUSHES	1
KR9007	PRIGIONIERI STUD BOLTS	1
KR9008	GRUPPO INVERTITORE PLUNGER GROUP	1
KR9009	TAPPO SUPERIORE UPPER PLUG	1
KR9010	PISTONE MOTORE AIR PISTON	1
KR9011	ASTA INVERTITORE ROD	1
KR9012	GRUPPO DISTRIBUZIONE DISTRIBUTION GROUP	1
KR9020	PISTONE POMPANTE PUMPING PISTON	1
KR9021	VALVOLA DI FONDO BOTTOM VALVE	1
KR9022	FILTRO PESCANTE (91F/71) SHANK FILTER (91F/71)	1
KR9023	MESSA A TERRA GROUNDED	1
KR9024	COLLETTORE MANIFOLD	1
KR9026	GRUPPO TENUTA INFERIORE LOWER SEAL GROUP	1
KR9033	COLLETTORE DI SCARICO DISCHARGE CONNECTION	1
KR9034	GOLFARO CON BOSSOLO GUIDA STELO BUSH	1

ELENCO RICAMBI FORNIBILI SINGOLARMENTE

LIST OF SPARE PARTS WHICH CAN BE SUPPLIED SEPARATELY

CODICE CODE	DESCRIZIONE DESCRIPTION	Q.TÀ QTY
10/22	PROLUNGA PESCANTE (91F/71) SUCTION TUBE EXTENSION (91F/71)	1
B160	CILINDRO MOTORE MOTOR CYLINDER	1
B266	STELO POMPANTE ROD	1
B294	PORTA TUBO (90F/71) HOSE CONNECTION (90F/71)	1
B343	TUBO PESCANTE SUCTION TUBE	1
KC375	PISTONE MOTORE PISTON	1
M094	VITE M8x20 SCREW M8x20	6
M100	VITE M12X25 SCREW M12X25	3
0004	FILTRO ARIA AIR FILTER	1
0006	SILENZIATORE MUFFLER	1
P034	PIASTRA SUPERIORE UPPER FLANGE	1
P035	PIASTRA INFERIORE LOWER FLANGE	1
P041	GUANCIA SINISTRA LEFT COVER	1
P042	GUANCIA DESTRA RIGHT COVER	1
P090	CORPO INFERIORE LOWER BODY	1
P133	CORPO SUPERIORE UPPER BODY	1

KIT GUARNIZIONI COMPLETI

TUTTE LE GUARNIZIONI (H...) MENZIONATE NELL'ESPLOSO SONO FORNIBILI ANCHE SINGOLARMENTE

COMPLETE GASKETS KIT

ALL THE O-RING (H...) MENTIONED IN THE EXPLODED VIEW CAN BE SUPPLIED SEPARATELY

CODICE CODE	DESCRIZIONE DESCRIPTION	Q.TÀ QTY
KR9050	KIT GUARNIZIONI MOTORE SUPERIORE GASKETS KIT FOR UPPER MOTOR	1
KR9054	KIT GUARNIZIONI PESCANTE GASKETS KIT FOR SUCTION TUBE	1
KR9055	KIT GUARNIZIONI PISTONE ø 90 GASKETS KIT FOR PISTON ø 90	1
KR9058	GRUPPO TENUTA INFERIORE LOWER SEAL GROUP	1

Art.
KS9084

SET RICAMBI CONSIGLIATI

AI PUNTI VENDITA E ASSISTENZA, COMPOSTO DAI RICAMBI SOTTO ELENCATI.

SPARE PARTS KIT ADVISED

TO THE SELLING CENTERS. THIS KIT INCLUDES ALL THE SPARE PARTS SHOWN HERE UNDER.

CODICE CODE	DESCRIZIONE DESCRIPTION	Q.TÀ QTY
KR9003	GRUPPO DISTRIBUZIONE ARIA SLIDE VALVE GROUP	1
KR9050	KIT GUARNIZIONI MOTORE SUPERIORE GASKETS KIT FOR UPPER MOTOR	1
KR9054	KIT GUARNIZIONI PESCANTE GASKETS KIT FOR SUCTION TUBE	1
KR9055	KIT GUARNIZIONI PISTONE ø 90 GASKETS KIT FOR PISTON ø 90	1
KR9058	GRUPPO TENUTA INFERIORE LOWER SEAL GROUP	1

PDFfill PDF Editor with Free Writer and Tools



Art. 91C/701 Mod. 900C-70194 - Art. 92C/701 Mod. 900C-70174

VISTA ESPLOSA - EXPLODED VIEW

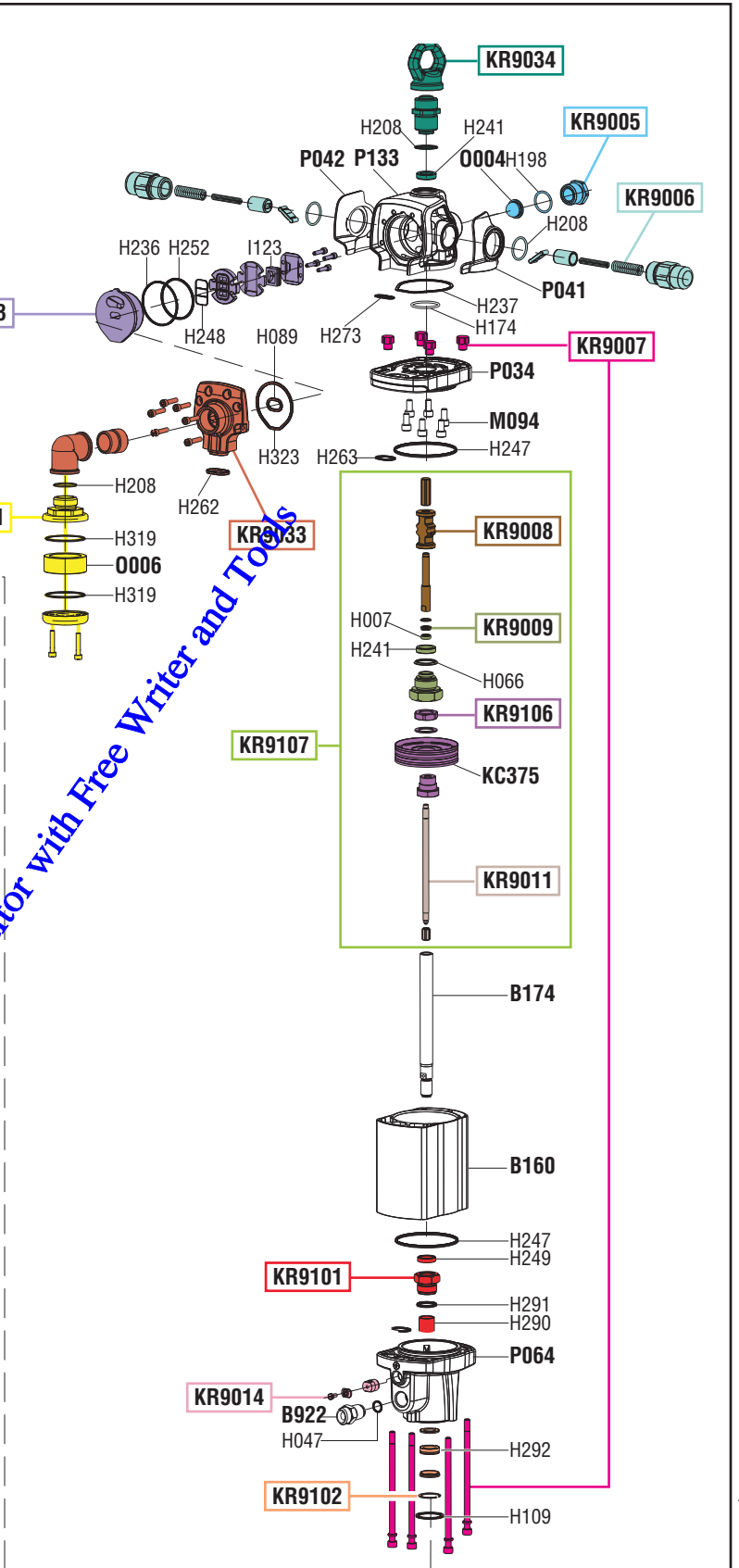
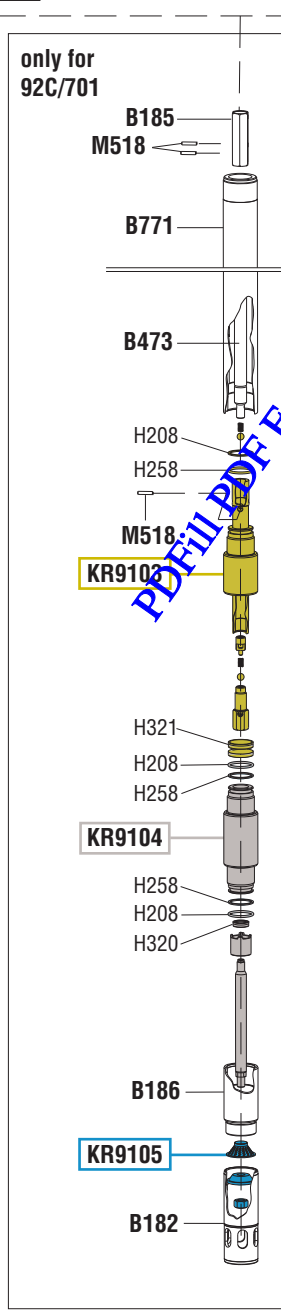
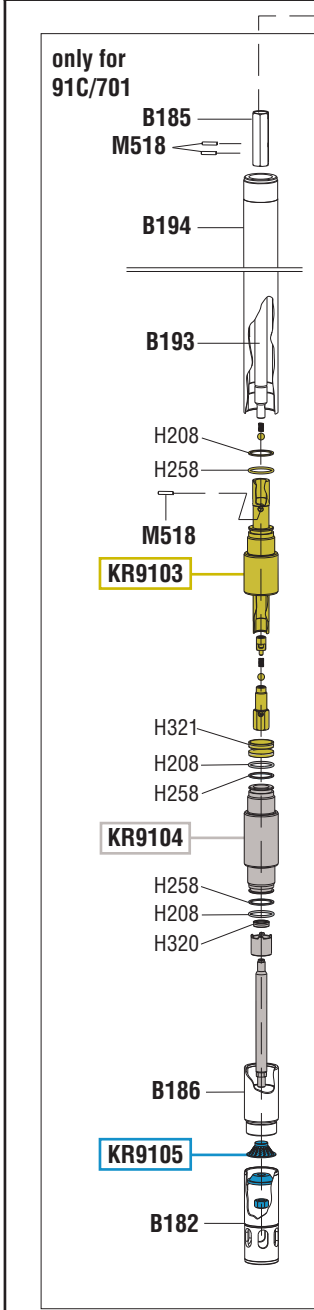
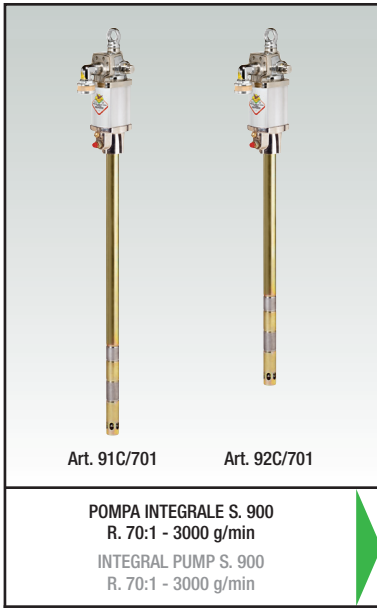

PDFFill PDF Editor with Free Writer and Tools

GUIDA RICAMBI - SPARE PARTS GUIDE

KIT RICAMBI OGNI KIT SOTTO RIPORTATO COMPRENDE I RICAMBI EVIDENZIATI CON LO STESSO COLORE E LE RELATIVE GUARNIZIONI. QUESTI RICAMBI NON SONO FORNIBILI SEPARATAMENTE TRANNE QUELLI CODIFICATI.		
SPARE PARTS KITS EACH KIT SHOWN WITH THE SAME COLOR INCLUDES ALSO THE GASKETS. THE SPARE PARTS INCLUDED IN THE KIT CAN'T BE SUPPLIED SEPARATELY EXCEPT THOSE SHOWN WITH A PROPER CODE.		
CODICE CODE	DESCRIZIONE DESCRIPTION	Q.TÀ QTY
KR9001	SILENZIATORE MUFFLER	1
KR9003	GRUPPO DISTRIBUTORE D'ARIA SLIDE VALVE GROUP	1
KR9005	RIDUZIONE ENTRATA AIR INLET CONNECTION	1
KR9006	BOSSOLI INVERTITORE BUSHES	1
KR9007	PRIGIONIERI STUD BOLTS	1
KR9008	GRUPPO INVERTITORE PLUNGER GROUP	1
KR9009	TAPPO SUPERIORE UPPER PLUG	1
KR9011	ASTA INVERTITORE ROD	1
KR9014	MESSA A TERRA GROUNDED	1
KR9033	COLLETTORE DI SCARICO DISCHARGE CONNECTION	1
KR9034	GOLFARO CON BOSSOLO GUIDA STELO BUSH	1
KR9101	GRUPPO TENUTA SUPERIORE UPPER SEAL GROUP	1
KR9102	GRUPPO TENUTA INFERIORE LOWER SEAL GROUP	1
KR9103	GRUPPO POMPANTE PUMPING GROUP	1
KR9104	GRUPPO PREPOMPAFFIO PUMPING GROUP	1
KR9105	FILTRO PESCANTE SHANK FILTER	1
KR9106	PISTONE MOTORE AIR PISTON	1
KR9107	GRUPPO DISTRIBUZIONE DISTRIBUTION GROUP	1

ELENCO RICAMBI FORNIBILI SINGOLARMENTE LIST OF SPARE PARTS WHICH CAN BE SUPPLIED SEPARATELY		
CODICE CODE	DESCRIZIONE DESCRIPTION	Q.TÀ QTY
B160	CILINDRO MOTORE MOTOR CYLINDER	1
B174	ALBERO PISTONE PISTON	1
B182	TERMINALE PESCANTE SHANK END	1
B185	GIUNTO JOINT	1
B186	CILINDRO BATTUTA VALVOLA BOTTOM VALVE CYLINDER	1
B193	STELO POMPANTE (91C/701) ROD (91C/701)	1
B194	TUBO PESCANTE (91C/701) SUCTION TUBE (91C/701)	1
B473	STELO POMPANTE (92C/701) ROD (92C/701)	1
B771	TUBO PESCANTE (92C/701) SUCTION TUBE (92C/701)	1
B922	NIPPLES USCITA OUTLET CONNECTION	1
KC375	PISTONE MOTORE PISTON	1
M094	VITE M8x20 SCREW M8x20	6
M518	SPINA ELASTICA PIN	1
0004	FILTRO ARIA AIR FILTER	1
0006	SILENZIATORE MUFFLER	1
P034	PIASTRA SUPERIORE UPPER FLANGE	1
P041	GUANCIA SINISTRA LEFT COVER	1
P042	GUANCIA DESTRA RIGHT COVER	1
P064	CORPO INFERIORE LOWER BODY	1
P133	CORPO SUPERIORE UPPER BODY	1

KIT GUARNIZIONI COMPLETI TUTTE LE GUARNIZIONI (H...) MENZIONATE NELL'ESPLOSO SONO FORNIBILI ANCHE SINGOLARMENTE		
COMPLETE GASKETS KIT ALL THE O-RING (H...) MENTIONED IN THE EXPLODED VIEW CAN BE SUPPLIED SEPARATELY		
CODICE CODE	DESCRIZIONE DESCRIPTION	Q.TÀ QTY
KR9050	KIT GUARNIZIONI MOTORE SUPERIORE GASKETS KIT FOR UPPER MOTOR	1
KR9055	KIT GUARNIZIONI PISTONE ø 90 GASKETS KIT FOR PISTON ø 90	1
KR9150	KIT GUARNIZIONI MOTORE INFERIORE GASKETS KIT FOR LOWER MOTOR	1
KR9151	KIT GUARNIZIONI PESCANTE GASKETS KIT FOR SUCTION TUBE	1

Art. KS9180		
SET RICAMBI CONSIGLIATI AI PUNTI VENDITA E ASSISTENZA, COMPOSTO DAI RICAMBI SOTTO ELENCATI.		
SPARE PARTS KIT ADVISED TO THE SELLING CENTERS, THIS KIT INCLUDES ALL THE SPARE PARTS SHOWN HERE UNDER.		
CODICE CODE	DESCRIZIONE DESCRIPTION	Q.TÀ QTY
KR9003	GRUPPO DISTRIBUZIONE ARIA SLIDE VALVE GROUP	1
KR9050	KIT GUARNIZIONI MOTORE SUPERIORE GASKETS KIT FOR UPPER MOTOR	1
KR9055	KIT GUARNIZIONI PISTONE ø 90 GASKETS KIT FOR PISTON ø 90	1
KR9150	KIT GUARNIZIONI MOTORE INFERIORE GASKETS KIT FOR LOWER MOTOR	1
KR9151	KIT GUARNIZIONI PESCANTE GASKETS KIT FOR SUCTION TUBE	1

PDFfill PDF Editor with Free Writer and Tools

GUIDA RICAMBI - SPARE PARTS GUIDE

KIT RICAMBI		
OGNI KIT SOTTO RIPORTATO COMPRENDE I RICAMBI EVIDENZIATI CON LO STESSO COLORE E LE RELATIVE GUARNIZIONI. QUESTI RICAMBI NON SONO FORNIBILI SEPARATAMENTE TRANNE QUELLI CODIFICATI.		
SPARE PARTS KITS		
EACH KIT SHOWN WITH THE SAME COLOR INCLUDES ALSO THE GASKETS. THE SPARE PARTS INCLUDED IN THE KIT CAN'T BE SUPPLIED SEPARATELY EXCEPT THOSE SHOWN WITH A PROPER CODE.		
CODICE CODE	DESCRIZIONE DESCRIPTION	Q.TÀ QTY
10/16	MANIGLIE HANDLES	1
KR9001	SILENZIATORE MUFFLER	1
KR9003	GRUPPO DISTRIBUTORE D'ARIA SLIDE VALVE GROUP	1
KR9005	RIDUZIONE ENTRATA AIR INLET CONNECTION	1
KR9006	BOSSOLI INVERTITORE BUSHES	1
KR9007	PRIGIONIERI STUD BOLTS	1
KR9008	GRUPPO INVERTITORE PLUNGER GROUP	1
KR9009	TAPPO SUPERIORE UPPER PLUG	1
KR9011	ASTA INVERTITORE ROD	1
KR9023	MESSA A TERRA GROUNDED	1
KR9024	COLLETTORE MANIFOLD	1
KR9033	COLLETTORE DI SCARICO DISCHARGE CONNECTION	1
KR9034	GOLFARO CON BOSSOLO GUIDA STELO BUSH	1
KR9102	GRUPPO TENUTA INFERIORE LOWER SEAL GROUP	1
KR9106	PISTONE MOTORE AIR PISTON	1
KR9107	GRUPPO DISTRIBUZIONE DISTRIBUTION GROUP	1
KR9108	GRUPPO TENUTA SUPERIORE UPPER SEAL GROUP	1
KR9111	GRUPPO POMPANTE PUMPING GROUP	1
KR9112	GRUPPO PREPOMPAGGIO PUMPING GROUP	1
KR9113	FILTRO PESCANTE SHANK FILTER	1

ELENCO RICAMBI FORNIBILI SINGOLARMENTE		
LIST OF SPARE PARTS WHICH CAN BE SUPPLIED SEPARATELY		
CODICE CODE	DESCRIZIONE DESCRIPTION	Q.TÀ QTY
B160	CILINDRO MOTORE MOTOR CYLINDER	1
B174	ALBERO PISTONE PISTON	1
B182	TERMINALE PESCANTE SHANK END	1
B186	CILINDRO BATTUTA VALVOLA BOTTOM VALVE CYLINDER	1
B193	STELO POMPANTE (91F/451) PUMPING ROD (91F/451)	1
B194	TUBO PESCANTE (91F/451) SUCTION TUBE (91F/451)	1
B450	GIUNTO (92F/451-91F/451) JOINT (92F/451-91F/451)	1
B473	STELO POMPANTE (92F/451) PUMPING ROD (92F/451)	1
B771	TUBO PESCANTE (92F/451) SUCTION TUBE (92F/451)	1
KC375	PISTONE MOTORE PISTON	1
M094	VITE M8x20 SCREW M8x20	6
M100	VITE M12x25 SCREW M12x25	3
M518	SPINA ELASTICA PIN	1
0004	FILTRO ARIA AIR FILTER	1
0006	SILENZIATORE MUFFLER	1
P034	PIASTRA SUPERIORE UPPER FLANGE	1
P035	PIASTRA INFERIORE LOWER FLANGE	1
P041	GUANCIA SINISTRA LEFT COVER	1
P042	GUANCIA DESTRA RIGHT COVER	1
P048	CORPO INFERIORE LOWER BODY	1
P133	CORPO SUPERIORE UPPER BODY	1

KIT GUARNIZIONI COMPLETI		
TUTTE LE GUARNIZIONI (H...) MENZIONATE NELL'ESPLOSO SONO FORNIBILI ANCHE SINGOLARMENTE		
COMPLETE GASKETS KIT		
ALL THE O-RING (H...) MENTIONED IN THE EXPLODED VIEW CAN BE SUPPLIED SEPARATELY		
CODICE CODE	DESCRIZIONE DESCRIPTION	Q.TÀ QTY
KR9050	KIT GUARNIZIONI MOTORE SUPERIORE GASKETS KIT FOR UPPER MOTOR	1
KR9055	KIT GUARNIZIONI PISTONE ø 90 GASKETS KIT FOR PISTON ø 90	1
KR9152	KIT GUARNIZIONI MOTORE INFERIORE GASKETS KIT FOR LOWER MOTOR	1
KR9153	KIT GUARNIZIONI PESCANTE GASKETS KIT FOR SUCTION TUBE	1

Art.	SET RICAMBI CONSIGLIATI	
KS9181	AI PUNTI VENDITA E ASSISTENZA, COMPOSTO DAI RICAMBI SOTTO ELENCATI.	
	SPARE PARTS KIT ADVISED	
	TO THE SELLING CENTERS, THIS KIT INCLUDES ALL THE SPARE PARTS SHOWN HERE UNDER.	
CODICE CODE	DESCRIZIONE DESCRIPTION	Q.TÀ QTY
KR9003	GRUPPO DISTRIBUZIONE ARIA SLIDE VALVE GROUP	1
KR9050	KIT GUARNIZIONI MOTORE SUPERIORE GASKETS KIT FOR UPPER MOTOR	1
KR9055	KIT GUARNIZIONI PISTONE ø 90 GASKETS KIT FOR PISTON ø 90	1
KR9152	KIT GUARNIZIONI PESCANTE GASKETS KIT FOR SUCTION TUBE	1
KR9153	KIT GUARNIZIONI MOTORE INFERIORE GASKETS KIT FOR LOWER MOTOR	1

PDFfill PDF Editor with Free Writer and Tools



Art. 94D/61 Mod. 940D-6100 - Art. 95D/61 Mod. 950D-6100



VISTA ESPLOSA - EXPLODED VIEW



Art. 94D/61

Art. 95D/61

POMPA DISSOCIATA AISI 304 S. 900
R. 6:1 - 42 l/min
DIVORCED PUMP AISI 304 S. 900
R 6:1 - 42 l/min

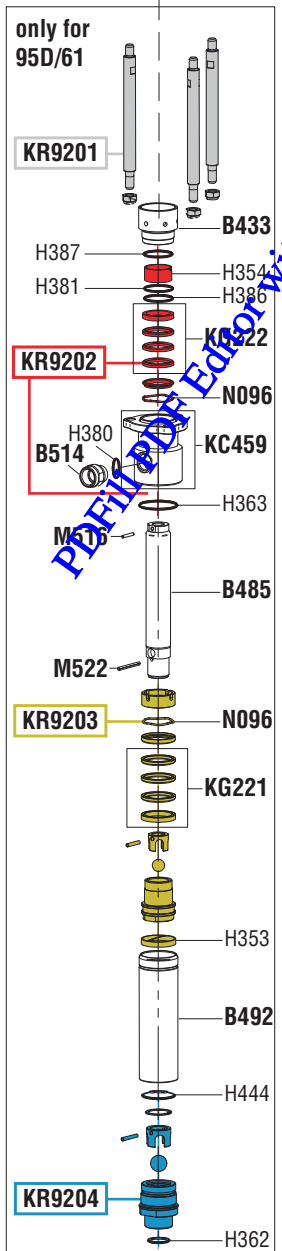
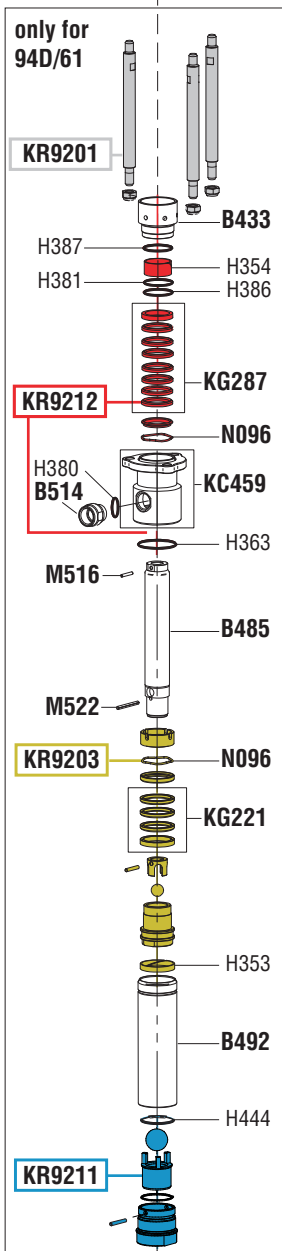
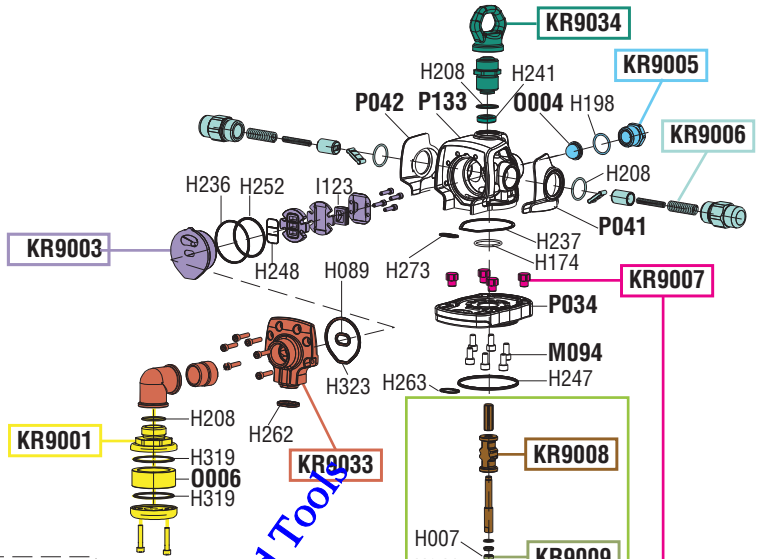

PDF File Editor With Free Writer and Tools

tutti i diritti riservati - all rights reserved

GUIDA RICAMBI - SPARE PARTS GUIDE

KIT RICAMBI OGNI KIT SOTTO RIPORTATO COMPRENDE I RICAMBI EVIDENZIATI CON LO STESSO COLORE E LE RELATIVE GUARNIZIONI. QUESTI RICAMBI NON SONO FORNIBILI SEPARATAMENTE TRANNE QUELLI CODIFICATI.		
SPARE PARTS KITS EACH KIT SHOWN WITH THE SAME COLOR INCLUDES ALSO THE GASKETS. THE SPARE PARTS INCLUDED IN THE KIT CAN'T BE SUPPLIED SEPARATELY EXCEPT THOSE SHOWN WITH A PROPER CODE.		
CODICE CODE	DESCRIZIONE DESCRIPTION	Q.TÀ QTY
KR9001	SILENZIATORE MUFFLER	1
KR9003	GRUPPO DISTRIBUTORE D'ARIA SLIDE VALVE GROUP	1
KR9005	RIDUZIONE ENTRATA AIR INLET CONNECTION	1
KR9006	BOSSOLI INVERTITORE BUSHES	1
KR9007	PRIGIONIERI STUD BOLTS	1
KR9008	GRUPPO INVERTITORE PLUNGER GROUP	1
KR9009	TAPPO SUPERIORE UPPER PLUG	1
KR9011	ASTA INVERTITORE ROD	1
KR9023	MESSA A TERRA GROUNDED	1
KR9024	COLLETTORE MANIFOLD	1
KR9033	COLLETTORE DI SCARICO DISCHARGE CONNECTION	1
KR9034	GOLFARO CON BOSSOLO GUIDA STELO BUSH	1
KR9106	PISTONE MOTORE AIR PISTON	1
KR9107	GRUPPO DISTRIBUZIONE DISTRIBUTION GROUP	1
KR9114	GRUPPO TENUTA INFERIORE LOWER SEAL GROUP	1
KR9201	PRIGIONIERI STUD BOLTS	1
KR9202	GRUPPO TENUTA INFERIORE - 95D/61 LOWER SEAL GROUP	1
KR9203	PISTONE POMPANTE PUMPING PISTON	1
KR9204	VALVOLA DI FONDO - 95D/61 BOTTOM VALVE	1
KR9211	VALVOLA DI FONDO - 94D/61 BOTTOM VALVE	1
KR9212	GRUPPO TENUTA INFERIORE - 94D/61 LOWER SEAL GROUP	1

ELENCO RICAMBI FORNIBILI SINGOLARMENTE LIST OF SPARE PARTS WHICH CAN BE SUPPLIED SEPARATELY		
CODICE CODE	DESCRIZIONE DESCRIPTION	Q.TÀ QTY
B160	CILINDRO MOTORE MOTOR CYLINDER	1
B174	ALBERO PISTONE PISTON	1
B433	GHIERA REGOLAZIONE REGULATING RING NUT	1
B485	STELO PESCANTE PUMPING ROD	1
B492	TUBO PESCANTE SUCTION TUBE	1
B514	NIPPLES USCITA OUTLET CONNECTION	1
KC375	PISTONE MOTORE PISTON	1
KC459	CORPO INFERIORE LOWER BODY	1
KG221	GUARNIZIONI GASKETS	1
KG222	GUARNIZIONI - 95D/61 GASKETS	1
KG287	GUARNIZIONI - 94D/61 GASKETS	1
M094	VITE M8x20 SCREW M8x20	6
M516	SPINA ELASTICA PIN	1
M522	SPINA ELASTICA PIN	1
N096	MOLLA SPRING	1
0004	FILTRO ARIA AIR FILTER	1
0006	SILENZIATORE MUFFLER	1
P034	PIASTRA SUPERIORE UPPER FLANGE	1
P035	PIASTRA INFERIORE LOWER FLANGE	1
P041	GUANCIA SINISTRA LEFT COVER	1
P042	GUANCIA DESTRA RIGHT COVER	1
P133	CORPO SUPERIORE UPPER BODY	1

KIT GUARNIZIONI COMPLETI TUTTE LE GUARNIZIONI (H...) MENZIONATE NELL'ESPLOSO SONO FORNIBILI ANCHE SINGOLARMENTE		
COMPLETE GASKETS KIT ALL THE O-RING (H...) MENTIONED IN THE EXPLODED VIEW CAN BE SUPPLIED SEPARATELY		
CODICE CODE	DESCRIZIONE DESCRIPTION	Q.TÀ QTY
KR9050	KIT GUARNIZIONI MOTORE SUPERIORE GASKETS KIT FOR UPPER MOTOR	1
KR9055	KIT GUARNIZIONI PISTONE ø 90 GASKETS KIT FOR PISTON ø 90	1
KR9250	KIT GUARNIZIONI MOTORE INFERIORE - 95D/61 GASKETS KIT FOR LOWER MOTOR - 95D/61	1
KR9251	KIT GUARNIZIONI PESCANTE - 95D/61 GASKETS KIT FOR SUCTION TUBE	1
KR9252	KIT GUARNIZIONI PESCANTE - 94D/61 GASKETS KIT FOR SUCTION TUBE	1
KR9253	KIT GUARNIZIONI MOTORE INFERIORE - 94D/61 GASKETS KIT FOR LOWER MOTOR - 94D/61	1

Art. KS9280 SET RICAMBI CONSIGLIATI - 95D/61 AI PUNTI VENDITA E ASSISTENZA, COMPOSTO DAI RICAMBI SOTTO ELENCATI. SPARE PARTS KIT ADVISED TO THE SELLING CENTERS, THIS KIT INCLUDES ALL THE SPARE PARTS SHOWN HERE UNDER.		
CODICE CODE	DESCRIZIONE DESCRIPTION	Q.TÀ QTY
KR9003	GRUPPO DISTRIBUZIONE ARIA SLIDE VALVE GROUP	1
KR9050	KIT GUARNIZIONI MOTORE SUPERIORE GASKETS KIT FOR UPPER MOTOR	1
KR9055	KIT GUARNIZIONI PISTONE ø 90 GASKETS KIT FOR PISTON ø 90	1
KR9250	KIT GUARNIZIONI MOTORE INFERIORE GASKETS KIT FOR LOWER MOTOR	1
KR9251	KIT GUARNIZIONI PESCANTE GASKETS KIT FOR SUCTION TUBE	1

Art. KS9282 SET RICAMBI CONSIGLIATI - 94D/61 AI PUNTI VENDITA E ASSISTENZA, COMPOSTO DAI RICAMBI SOTTO ELENCATI. SPARE PARTS KIT ADVISED TO THE SELLING CENTERS, THIS KIT INCLUDES ALL THE SPARE PARTS SHOWN HERE UNDER.		
CODICE CODE	DESCRIZIONE DESCRIPTION	Q.TÀ QTY
KR9003	GRUPPO DISTRIBUZIONE ARIA SLIDE VALVE GROUP	1
KR9050	KIT GUARNIZIONI MOTORE SUPERIORE GASKETS KIT FOR UPPER MOTOR	1
KR9055	KIT GUARNIZIONI PISTONE ø 90 GASKETS KIT FOR PISTON ø 90	1
KR9252	KIT GUARNIZIONI PESCANTE GASKETS KIT FOR SUCTION TUBE	1
KR9253	KIT GUARNIZIONI MOTORE INFERIORE GASKETS KIT FOR LOWER MOTOR	1



Art. 9430.100 Mod. 9430-20 bar - Art. 9430.200 Mod. 9430-100 bar
 Art. 9430.300 Mod. 9430-200 bar - Art. 9430.400 Mod. 9430-150 bar
 Art. 9430.500 Mod. 9430-600 bar



VISTA ESPLOSA - EXPLODED VIEW

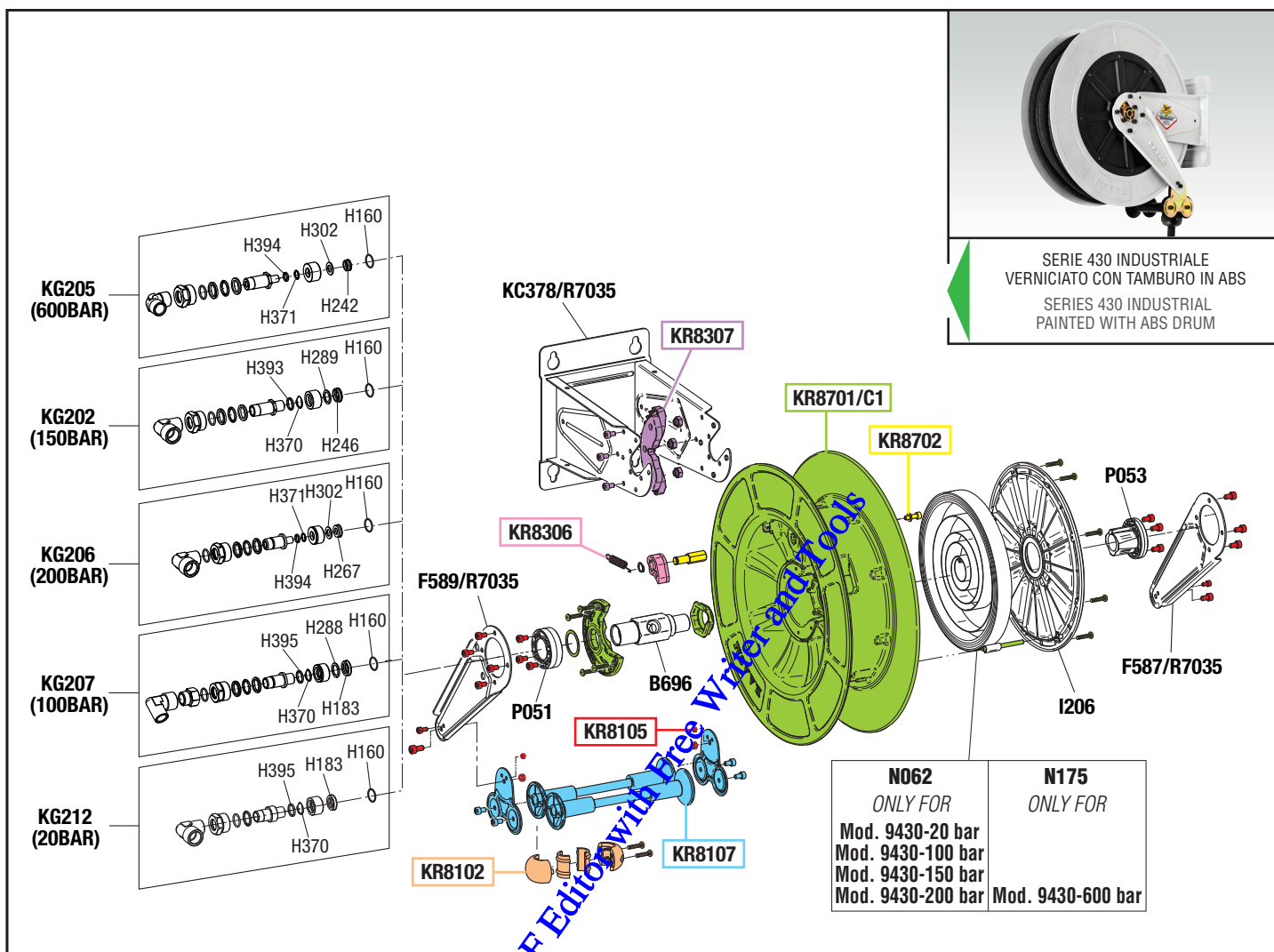

tutti i diritti riservati - all rights reserved

GUIDA RICAMBI - SPARE PARTS GUIDE

KIT RICAMBI
 OGNI KIT SOTTO RIPORTATO COMPRENDE I RICAMBI EVIDENZIATI CON LO STESSO COLORE E LE RELATIVE GUARNIZIONI. QUESTI RICAMBI NON SONO FORNIBILI SEPARATAMENTE TRANNE QUELLI CODIFICATI.

SPARE PARTS KITS
 EACH KIT SHOWN WITH THE SAME COLOR INCLUDES ALSO THE GASKETS. THE SPARE PARTS INCLUDED IN THE KIT CAN'T BE SUPPLIED SEPARATELY EXCEPT THOSE SHOWN WITH A PROPER CODE.

CODICE CODE	DESCRIZIONE DESCRIPTION	Q.TÀ QTY
KR8102	TAMPONE FERMATUBO HOSE STOP	1
KR8105	SET VITI AVVOLGITUBO SET OF SCREWS FOR HOSEREEL	1
KR8107	KIT PORTA RULLI AVVOLGITUBO ROLLERS HOLDING KIT FOR HOSEREEL	1
KR8306	DENTE D'ARRESTO DETENT	1
KR8307	KIT CREMAGLIERA RACK KIT	1
KR8701/C1	KIT TAMBURO IN ABS ABS DRUM KIT	1
KR8702	PERNO PORTACRICCO PIN	1

ELENCO RICAMBI FORNIBILI SINGOLARMENTE
 LIST OF SPARE PARTS WHICH CAN BE SUPPLIED SEPARATELY

CODICE CODE	DESCRIZIONE DESCRIPTION	Q.TÀ QTY
B696	PERNO CENTRALE CENTRAL PIN	1
F587/R7035	BRACCIO ORIENTABILE SWINGING ARM	1
F589/R7035	BRACCIO ORIENTABILE SWINGING ARM	1
I206	CARTER COVER	1
KC378/R7035	SUPPORTO AVVOLGITUBO HOSEREEL SUPPORT	1
KG202	SNODO OLIO 150 bar JOINT OIL 150 bar	1
KG205	SNODO GRASSO 600 bar JOINT GREASE 600 bar	1
KG206	SNODO ACQUA 200 bar JOINT WATER 200 bar	1
KG207	SNODO ACQUA 100 bar JOINT WATER 100 bar	1
KG212	SNODO ARIA-ACQUA 20 bar JOINT AIR-WATER 20 bar	1
N062	MOLLA SPRING	1
N175	MOLLA (Art. 9430.500) SPRING (Art. 9430.500)	1
P051	BOCCOLA LATO CREMAGLIERA BUSH	1
P053	BOCCOLA LATO MOLLA BUSH	1

ELENCO GUARNIZIONI SNODI
 JOINTS GASKETS LIST

CODICE CODE	DESCRIZIONE DESCRIPTION	Q.TÀ QTY
H160	O-RING 2093 O-RING 2093	1
H183	GUARNIZIONE GASKET	1
H242	GUARNIZIONE GASKET	1
H246	GUARNIZIONE GASKET	1
H267	GUARNIZIONE "VITON 90SH" GASKET "VITON 90SH"	1
H288	RONDELLA IN "PTFE" WASHER "PTFE"	1
H289	RONDELLA IN "PTFE" WASHER "PTFE"	1
H302	RONDELLA IN "PTFE" WASHER "PTFE"	1
H370	O-RING 2062 "VITON" O-RING 2062 "VITON"	1
H371	O-RING 2037 "VITON" O-RING 2037 "VITON"	1
H393	RONDELLA IN "PTFE" WASHER "PTFE"	1
H394	RONDELLA IN "PTFE" WASHER "PTFE"	1
H395	RONDELLA IN "PTFE" WASHER "PTFE"	1



Art. 9450.100 Mod. 9450-20 bar - Art. 9450.400 Mod. 9450-150 bar
 Art. 9450.500 Mod. 9450-600 bar



VISTA ESPLOSA - EXPLODED VIEW

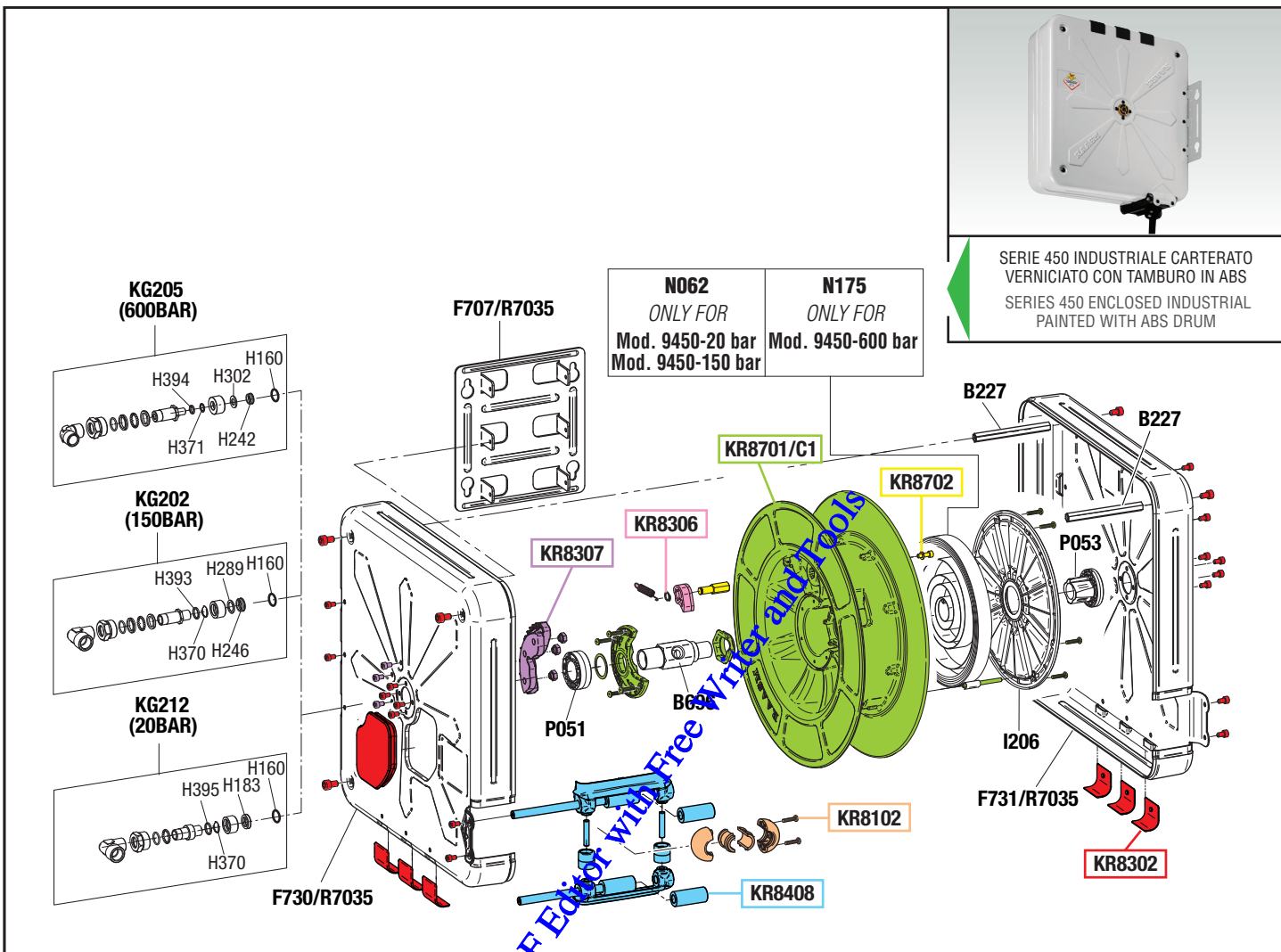

SERIE 450 INDUSTRIALE CARTERATO
 VERNICIATO CON TAMBURO IN ABS
 SERIES 450 ENCLOSED INDUSTRIAL
 PAINTED WITH ABS DRUM

N062
 ONLY FOR
 Mod. 9450-20 bar
 Mod. 9450-150 bar

N175
 ONLY FOR
 Mod. 9450-600 bar

tutti i diritti riservati - all rights reserved

GUIDA RICAMBI - SPARE PARTS GUIDE

KIT RICAMBI
 OGNI KIT SOTTO RIPORTATO COMPRENDE I RICAMBI EVIDENZIATI CON LO STESSO COLORE E LE RELATIVE GUARNIZIONI. QUESTI RICAMBI NON SONO FORNIBILI SEPARATAMENTE TRANNE QUELLI CODIFICATI.

SPARE PARTS KITS
 EACH KIT SHOWN WITH THE SAME COLOR INCLUDES ALSO THE GASKETS. THE SPARE PARTS INCLUDED IN THE KIT CAN'T BE SUPPLIED SEPARATELY EXCEPT THOSE SHOWN WITH A PROPER CODE.

CODICE CODE	DESCRIZIONE DESCRIPTION	Q.TÀ QTY
KR8102	TAMPONE FERMATUBO HOSE STOP	1
KR8302	SET VITI ARROTOLATORE SET OF SCREWS FOR HOSEREEL	1
KR8306	DENTE D'ARRESTO DETENT	1
KR8307	KIT CREMAGLIERA RACK KIT	1
KR8408	KIT PORTA RULLI AVVOLGITUBO ROLLERS HOLDING KIT FOR HOSEREEL	1
KR8701/C1	KIT TAMBURO IN ABS ABS DRUM KIT	1
KR8702	PERNO PORTACRICCO PIN	1

ELENCO RICAMBI FORNIBILI SINGOLARMENTE
 LIST OF SPARE PARTS WHICH CAN BE SUPPLIED SEPARATELY

CODICE CODE	DESCRIZIONE DESCRIPTION	Q.TÀ QTY
B227	PRIGIONIERO SLEEVE	2
B696	PERNO CENTRALE CENTRAL PIN	1
F707/R7035	STAFFA BRACKET	1
F730/R7035	CARTER LATO CREMAGLIERA RACK SIDE COVER	1
F731/R7035	CARTER LATO MOLLA SPRING SIDE COVER	1
I206	CARTER COVER	1
KG202	SNODO OLIO 150 BAR JOINT OIL 150 BAR	1
KG205	SNODO GRASSO 600 BAR JOINT GREASE 600 BAR	1
KG212	SNODO ARIA-ACQUA 20 BAR JOINT AIR-WATER 20 BAR	1
N062	MOLLA SPRING	1
N175	MOLLA (Art. 9450.500) SPRING (Art. 9450.500)	1
P051	BOCCOLA LATO CREMAGLIERA BUSH	1
P053	BOCCOLA LATO MOLLA BUSH	1

ELENCO GUARNIZIONI SNODI
 JOINTS GASKETS LIST

CODICE CODE	DESCRIZIONE DESCRIPTION	Q.TÀ QTY
H160	O-RING 2093 O-RING 2093	1
H183	GUARNIZIONE GASKET	1
H242	GUARNIZIONE GASKET	1
H246	GUARNIZIONE GASKET	1
H289	RONDELLA IN "PTFE" WASHER "PTFE"	1
H302	RONDELLA IN "PTFE" WASHER "PTFE"	1
H370	O-RING 2062 "VITON" O-RING 2062 "VITON"	1
H371	O-RING 2037 "VITON" O-RING 2037 "VITON"	1
H393	RONDELLA IN "PTFE" WASHER "PTFE"	1
H394	RONDELLA IN "PTFE" WASHER "PTFE"	1
H395	RONDELLA IN "PTFE" WASHER "PTFE"	1

PDFill PDF Editor with Free Writer and Tools





RAASM

FLUIDS AND LUBRICATION EQUIPMENT

 La ditta costruttrice declina ogni responsabilità per le possibili inesattezze contenute nel presente catalogo imputabili ad errori di stampa o di trascrizione.
Si riserva inoltre di apportare, senza preavviso, ed in totale libertà operativa, ogni e qualsiasi variante e miglioria d'ordine funzionale-tecnico ed estetica.

 The manufacturer declines all responsibility for possible imprecisions contained in this catalogue, due to misprints or clerical errors.
Moreover, the manufacturer reserves the right to bring about any technical-functional and design change or improvement, without any previous notice and with the utmost operational freedom.

 The manufacturer declines all responsibility for possible imprecisions contained in this catalogue, due to misprints or clerical errors.
Moreover, the manufacturer reserves the right to bring about any technical-functional and design change or improvement, without any previous notice and with the utmost operational freedom.

 The manufacturer declines all responsibility for possible imprecisions contained in this catalogue, due to misprints or clerical errors.
Moreover, the manufacturer reserves the right to bring about any technical-functional and design change or improvement, without any previous notice and with the utmost operational freedom.

 The manufacturer declines all responsibility for possible imprecisions contained in this catalogue, due to misprints or clerical errors.
Moreover, the manufacturer reserves the right to bring about any technical-functional and design change or improvement, without any previous notice and with the utmost operational freedom.

FLUIDS AND LUBRICATION EQUIPMENT

PDFill PDF Editor with Free Writer and Tools

 Riservato ogni diritto di riproduzione ed utilizzo

 All rights of production and use reserved

 Tout droit de reproduction et utilisation reserve

 Alle reproduktions-und Gebrauchsrechte vorbehalten

 Reservado todo derecho de reproduccion y de utilizacion

RAASIA

PDFill PDF Editor with Free Writer and Tools

RAASM S.p.A.

36022 S. ZENO DI CASSOLA (VI) - Via Marangoni, 33 - ITALY

Ufficio Commerciale Tel. 0424 571120 - Fax 0424 571145
Ufficio Tecnico Tel. 0424 571150 - Fax 0424 571155

Export department Tel. 0424 571130 - Fax 0424 571135
Technical department Tel. 0424 571150 - Fax 0424 571155

info@raasm.com - www.raasm.com

CE Made in Italy

